



**THE DATASHEET OF
SPC5606BF1VLU6**



Qorivva MPC560xB/C/D Family



Automotive body and gateway applications

Overview

The Qorivva MPC560xB/C/D family of 32-bit MCU includes the latest Freescale integrated devices for automotive body electronics applications. The advanced cost-efficient host processor core leverages the many strengths of Power Architecture® technology, such as processing capability, on-chip memory, analog capabilities, timing systems and other features required to handle complex control and diagnostic systems. In addition, these scalable devices are supported by an enablement ecosystem that includes software drivers, operating systems and configuration code to help you quickly implement your designs.

Applications

- Central body controllers
- Gateway controllers
- Body electronics
- Comfort controls

Qorivva MPC560xB/C/D Key Features

Includes controller area network (CAN), local interconnect network (LIN) and other peripherals necessary to implement a range of functionality in the automotive body network.

- FlexCAN module supporting both FIFO and mailbox data storage, ideal for CAN gateways to manage event-driven vs. periodic bus traffic.
- LINFlex module provides fully automated LIN message management, reducing CPU load intervention and message latencies.
- eMIOS timer combines multiple counter sources, including input capture, output compare and pulse width modulation (PWM) capabilities into one very flexible module. PWM function supports shifted signal output to improve electromagnetic compatibility.
- Cross triggering unit synchronizes PWM output signals with analog-to-digital conversion to enable accurate diagnostic and control capabilities.

Qorivva MPC560xB/C Block Diagram

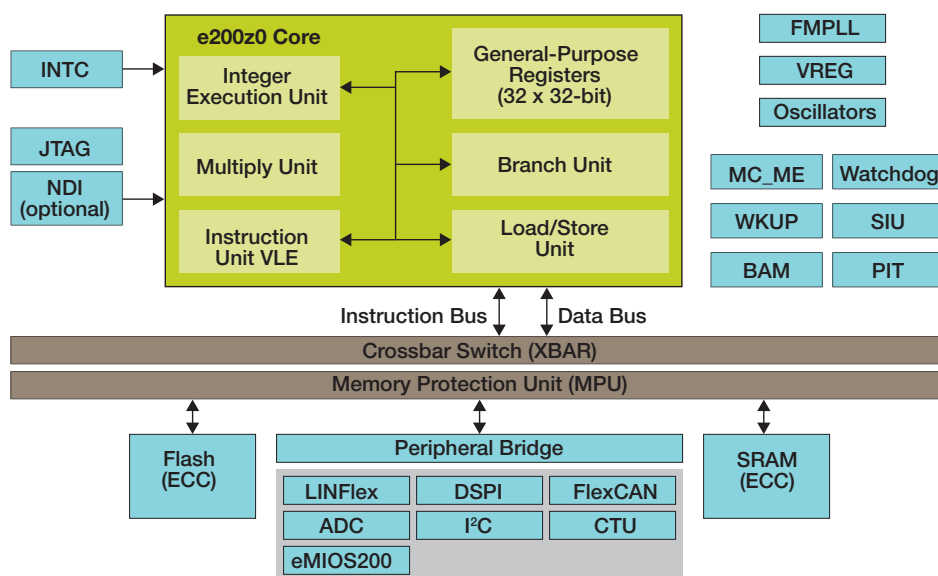

- Scalable e200z0 core enables migration toward higher performance solutions.
- Compatible family of products ensures reuse of software and tools infrastructures.

In addition, the Qorivva MPC5601D, MPC5602D, MPC5605B, MPC5606B and MPC5607B are available with direct memory access.



Selector Guide

Product Number	Temp. Ranges	Features	Package	Speed
MPC5607B	-40 °C to +125 °C	1.5 MB Flash, 6 CAN, 6 SPI, 10 LINFlex, 64 KB Data Flash, 96 KB RAM, 16-bit Timer (64 channels), 12-bit ADC (16 channels) and 10-bit ADC (32 channels)	176 LQFP	Up to 64 MHz
MPC5606B	-40 °C to +125 °C	1 MB Flash, 6 CAN, up to 6 SPI, up to 8 LINFlex, 64 KB Data Flash, 80 KB RAM, 16-bit Timer (64 channels), 12-bit ADC (16 channels) and 10-bit ADC (up to 32 channels)	144 LQFP, 176 LQFP	Up to 64 MHz
MPC5605B	-40 °C to +125 °C	768 KB Flash, 6 CAN, up to 6 SPI, up to 8 LINFlex, 64 KB Data Flash, 64 KB RAM, 16-bit Timer (up to 64 channels), 12-bit ADC (16 channels) and 10-bit ADC (up to 32 channels)	100 LQFP, 144 LQFP, 176 LQFP	Up to 64 MHz
MPC5604C	-40 °C to +125 °C	512 KB Flash, 6 CAN, 3 SPI, 4 LINFlex, 64 KB Data Flash EEPROM, 48 KB RAM, 16-bit Timer (up to 28 channels), 10-bit ADC (up to 28 channels)	64 LQFP, 100 LQFP	Up to 64 MHz
MPC5604B	-40 °C to +125 °C	512 KB Flash, 3 CAN, 3 SPI, 4 LINFlex, 64 KB Data Flash EEPROM, 32 KB RAM, 16-bit Timer (up to 56 channels), 10-bit ADC (up to 36 channels)	64 LQFP, 100 LQFP, 144 LQFP	Up to 64 MHz
MPC5603C	-40 °C to +125 °C	384 KB Flash, 6 CAN, 3 SPI, 4 LINFlex, 64 KB Data Flash EEPROM, 40 KB RAM, 16-bit Timer (up to 28 channels), 10-bit ADC (up to 28 channels)	64 LQFP, 100 LQFP	Up to 64 MHz
MPC5603B	-40 °C to +125 °C	384 KB Flash, 2 CAN, 3 SPI, 4 LINFlex, 64 KB Data Flash EEPROM, 28 KB RAM, 16-bit Timer (up to 56 channels), 10-bit ADC (up to 36 channels)	64 LQFP, 100 LQFP, 144 LQFP	Up to 64 MHz
MPC5602D	-40 °C to +125 °C	256 KB Flash, 1 CAN, 2 SPI, 3 LINFlex, 64 KB Data Flash EEPROM, 16 KB RAM, 16-bit Timer (up to 28 channels), 12-bit ADC (up to 33 channels)	64 LQFP, 100 LQFP	Up to 48 MHz
MPC5602C	-40 °C to +125 °C	256 KB Flash, 6 CAN, 3 SPI, 4 LINFlex, 64 KB Data Flash EEPROM, 32 KB RAM, 16-bit Timer (up to 28 channels), 10-bit ADC (up to 28 channels)	64 LQFP, 100 LQFP	Up to 64 MHz
MPC5602B	-40 °C to +125 °C	256 KB Flash, 2 CAN, 2 SPI, 3 LINFlex, 64 KB Data Flash EEPROM, 24 KB RAM, 16-bit Timer (up to 56 channels), 10-bit ADC (up to 36 channels)	64 LQFP, 100 LQFP, 144 LQFP	Up to 64 MHz
MPC5601D	-40 °C to +125 °C	128 KB Flash, 1 CAN, 2 SPI, 3 LINFlex, 64 KB Data Flash EEPROM, 12 KB RAM, 16-bit Timer (up to 28 channels), 12-bit ADC (up to 33 channels)	64 LQFP, 100 LQFP	Up to 48 MHz

Development Tools

Part Number	Description	Pricing*
For MPC5605B, MPC5606B and MPC5607B		
XKT560B176SB15M	Kit Includes JDP Motherboard (XPC56XXMB2), Daughter Card (XDC560B176SB15M) and P&E Wiggler	\$497
XKT560B144SB15M	Kit Includes JDP Motherboard (XPC56XXMB2), Daughter Card (XDC560B144SB15M) and P&E Wiggler	\$497
XKT560B100SB15M	Kit Includes JDP Motherboard (XPC56XXMB2), Daughter Card (XDC560B100SB15M) and P&E Wiggler	\$497
XKT560B208SB15M	Kit Includes JDP Motherboard (XPC56XXMB2), Daughter Card (XDC560B208SB15M) and P&E Wiggler	\$497
XDC560B176SB15M	176 LQFP Daughter Card	\$120
XDC560B144SB15M	144 LQFP Daughter Card	\$120
XDC560B100SB15M	100 LQFP Daughter Card	\$120
XDC560B208SB15M	208 MAPBGA Daughter Card	\$120
TRK-MPC5606B	144 LQFP StarterTRAK Board	\$99
For MPC5602B, MPC5602C, MPC5603B, MPC5603C, MPC5604B and MPC5604C		
XKT560B144SC512K	Kit Includes JDP Motherboard (XPC56XXMB2), Daughter Card (XDC560B144SC512K) and P&E Wiggler	\$497
XKT560B100SC512K	Kit Includes JDP Motherboard (XPC56XXMB2), Daughter Card (XDC560B100SC512K) and P&E Wiggler	\$497
XKT560B208SC512K	Kit Includes JDP Motherboard (XPC56XXMB2), Daughter Card (XDC560B208SC512K) and P&E Wiggler	\$497
XDC560B144SC512K	144 LQFP Daughter Card	\$120
XDC560B100SC512K	100 LQFP Daughter Card	\$120
XDC560B208SC512K	208 MAPBGA Daughter Card	\$120
TRK-USB-MPC5604B	100 LQFP StarterTRAK Mini	\$25
MPC5602D and MPC5601D		
XDC560B100SC256K	100 LQFP Daughter Card	\$120
XDC560B64SC256K	64 LQFP Daughter Card	\$120
For all MPC560xB/C/D		
XPC56XXMB2	JDP Motherboard	\$375

*Manufacturer Suggested Resale Price

For more information about Qorivva MPC560xB/C/D family solutions, please visit freescale.com/Qorivva



Freescale and the Freescale logo are trademarks of Freescale Semiconductor, Inc., Reg. U.S. Pat. & Tm. Off. Qorivva is a trademark of Freescale Semiconductor, Inc. The Power Architecture and Power.org word marks and the Power and Power.org logos and related marks are trademarks and service marks licensed by Power.org. All other product or service names are the property of their respective owners. © 2005, 2010, 2011, 2012 Freescale Semiconductor, Inc.

Document Number: MPC560XB/FAMFS REV 6

Looking for pricing, stock, or lifecycle information?

Click below to explore more details on WIN SOURCE:

 [View SPC5606BF1VLU6 on WIN SOURCE](#)

 [NXP / Nexperia Information](#)

Optimize Your Supply Chain with WIN SOURCE Solutions

-  Global Sourcing Solution
-  Obsolete Management
-  Cost Control Management
-  Shortage Management
-  Alternative Solution
-  Excess Inventory Management