



**THE DATASHEET OF
SMD2016B050TF**



DATA SHEET

POSITIVE TEMPERATURE COEFFICIENT AC/DC POWER SUPPLY

SMD2016 series

RoHS compliant & Halogen free



Product specification— July 10, 2023 V.4



Positive Temperature Coefficient (PTC) Data Sheet

Description

The 2016 series provides miniature surface mount resettable overcurrent protection with holding current from 0.3A to 5.0A. This series is suitable for applications with applications where space is at a premium and the device current is low.

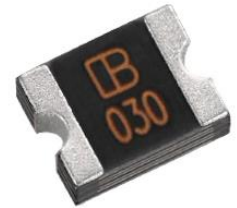

Features

- RoHS compliant and lead-free
- Fast response to fault current
- UL/CUL/TUV/RoHS/Halogen Free
- Low profile
- Compatible with high temperature solders
- Compact design saves board space

Applications

- USB hubs, ports and peripherals
- Set-top-box and HDMI
- Game console port protection
- Motherboard USB & IEEE 1394 protection
- Optical disk drives
- General electronics

Part Number Code and Marking

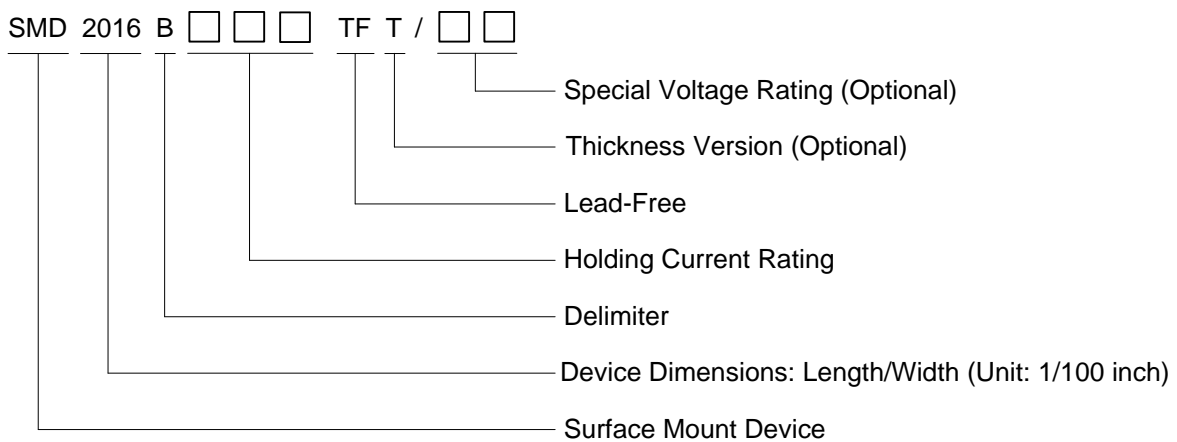

Part Number	Marking	Part Number	Marking	Part Number	Marking
SMD2016B030TF	030	SMD2016B100TF/33	1033	SMD2016B260TF/24	2624
SMD2016B050TF	050	SMD2016B150TF	150	SMD2016B300TF	300
SMD2016B075TF	075	SMD2016B150TF/33	1533	SMD2016B500TF	500
SMD2016B100TF	100	SMD2016B200TF	200		

Dimensions and PAD-SIZE

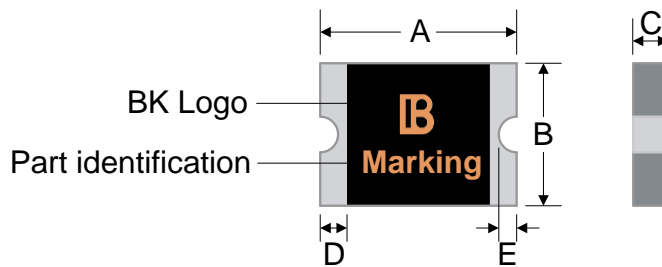

Part Number	A		B		C		D		E	
	Min.	Max.	Min.	Max.	Min.	Max.	Min.	Max.	Min.	Max.
SMD2016B030TF	4.72	5.44	3.70	4.43	0.55	1.05	0.30	1.50	0.25	0.65
SMD2016B050TF	4.72	5.44	3.70	4.43	0.85	1.35	0.30	1.50	0.25	0.65
SMD2016B075TF	4.72	5.44	3.70	4.43	1.65	2.45	0.30	1.50	0.25	0.65
SMD2016B100TF	4.72	5.44	3.70	4.43	0.50	1.00	0.30	1.50	0.25	0.65
SMD2016B100TF/33	4.72	5.44	3.70	4.43	0.75	1.25	0.30	1.50	0.25	0.65
SMD2016B150TF	4.72	5.44	3.70	4.43	0.50	1.00	0.30	1.50	0.25	0.65
SMD2016B150TF/33	4.72	5.44	3.70	4.43	0.70	1.20	0.30	1.50	0.25	0.65
SMD2016B200TF	4.72	5.44	3.70	4.43	0.55	1.05	0.30	1.50	0.25	0.65
SMD2016B260TF/24	4.72	5.44	3.70	4.43	1.25	2.05	0.30	1.50	0.25	0.65
SMD2016B300TF	4.72	5.44	3.70	4.43	0.90	1.70	0.30	1.50	0.25	0.65
SMD2016B500TF	4.72	5.44	3.70	4.43	0.85	1.65	0.30	1.50	0.25	0.65

Recommended Pad Layout (mm)

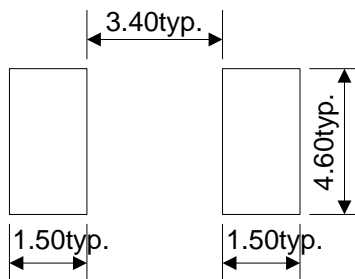

Electrical Characteristics

Part Number	I _{hold} (A)	I _{trip} (A)	V _{max} (Vdc)	I _{max} (A)	P _{d typ.} (W)	Maximum Time To Trip		Resistance	
						Time (Sec.)	Current (A)	R _{min} (Ω)	R _{1max} (Ω)
SMD2016B030TF	0.30	0.60	60	20	1.4	3.0	1.5	0.50	2.30
SMD2016B050TF	0.55	1.10	60	20	1.4	5.0	2.5	0.20	1.00
SMD2016B075TF	0.75	1.55	60	20	1.4	0.5	8.0	0.13	0.90
SMD2016B100TF	1.10	2.20	15	40	1.4	0.5	8.0	0.06	0.40
SMD2016B100TF/33	1.10	2.20	33	40	1.4	0.5	8.0	0.06	0.40
SMD2016B150TF	1.50	3.00	15	40	1.0	1.0	8.0	0.05	0.18
SMD2016B150TF/33	1.50	3.00	33	40	2.0	1.0	8.0	0.07	0.18
SMD2016B200TF	2.00	4.20	6	40	1.4	3.0	8.0	0.03	0.10
SMD2016B260TF/24	2.60	5.00	24	40	1.6	5.0	8.0	0.025	0.075
SMD2016B300TF	3.00	5.00	16	40	1.6	10.0	8.0	0.015	0.048
SMD2016B500TF	5.00	10.00	6	100	2.0	2.0	25.0	0.005	0.025

Note on Electrical Characteristics

■ Vocabulary

- I_{hold} = Hold current: maximum current device will pass without tripping in 23°C still air.
- I_{trip} = Trip current: minimum current at which the device will trip in 23°C still air.
- V_{max} = Maximum voltage device can withstand without damage at rated current (I_{max})
- I_{max} = Maximum fault current device can withstand without damage at rated voltage (V_{max})
- P_{d typ.} = Typical power dissipated from device when in the tripped state at 23°C still air.
- R_{min} = Minimum resistance of device in initial (un-soldered) state.
- R_{1max} = Maximum resistance of device at 23°C measured one hour after tripping or reflow soldering of 260°C for 20 sec.

■ Value specified is determined by using the PWB with 0.090"×1.5oz copper traces.

■ Caution: Operation beyond the specified rating may result in damage and possible arcing and flame.

Polymeric PTC Selecting Guide

- Determine the following operating parameters for the circuits:
 - Normal operating current (I_{hold})
 - Maximum interrupt current (I_{max})
 - Maximum circuit voltage (V_{max})
 - Normal operating temperature surrounding device (min°C/max°C)
- Select the device from factor and dimension suitable for the application
- Compare the maximum rating for V_{max} and I_{max} of the PPTC device with the circuit in application and make sure the circuit's requirement does not exceed the device rating.
- Check that PPTC device's trip time (time-to-trip) will protect the circuit.
- Verify that the circuit operating temperature is within the PPTC device's normal operating temperature range.
- Verify that performance and suitability of the chosen PPTC device in the application.

WARNING

- Mechanical Stress
 - PPTC devices will undergo a thermal expansion during fault condition. If PPTC devices are installed or placed in an application where the space between PPTC devices and the surrounding materials (e.g., covering materials, packaging materials, encapsulate materials and the like) is insufficient, it will cause an inhibiting effect upon the thermal expansion. Pressing, twisting, bending and other kinds of mechanical stress will also adversely affect the performance of the PPTC devices, and shall not be used or applied.
- Chemical Pollutants
 - Silicone-based oils, oils, solvents, gels, electrolytes, fuels, acids, and the like will adversely affect the properties of PPTC devices, and shall not be used or applied.
- Electronic and Thermal Effect
 - PPTC devices are secondary protection devices and are used solely for sporadic, accidental over-current or over-temperature error condition, and shall NOT be used if or when constant or repeated fault conditions (such fault conditions may be caused by, among others, incorrect pin-connection of a connector) or over-extensive trip events may occur.
 - PPTC devices are different from fuses and, when a fault condition occurs, will go into high-resistance state and do not open circuit, in which case the voltage at such PPTC devices may reach a hazardous level.
 - Operation over the maximum rating or other forms of improper use may cause failure, arcing, flame and/or other damage to the PPTC devices.
 - Conductive material contamination, such as metal particle, may induce shortage, flame or arcing.
 - Due to the inductance, the operation circuits may generate a circuit voltage (Ldi/dt) above the rated voltage of PPTC devices, which shall not be used under such circumstances.
- General
 - Customers shall evaluate and test the properties of PPTC devices independently to verify and ensure that their individual applications will be met.
 - The performance of PPTC devices will be adversely affected if they are improperly used under electronic, thermal and/or mechanical procedures and/or conditions non-conformant to those recommended by manufacturer.
 - Customers shall be responsible for determining whether it is necessary to have back-up, failsafe and/or fool-proof protection To avoid or minimize damage that may result from extra-ordinary, irregular function or failure of PPTC devices.
 - Any and all responsibilities and liabilities are disclaimed if any item under this notice of warning is not complied with.

Thermal Derating Curve

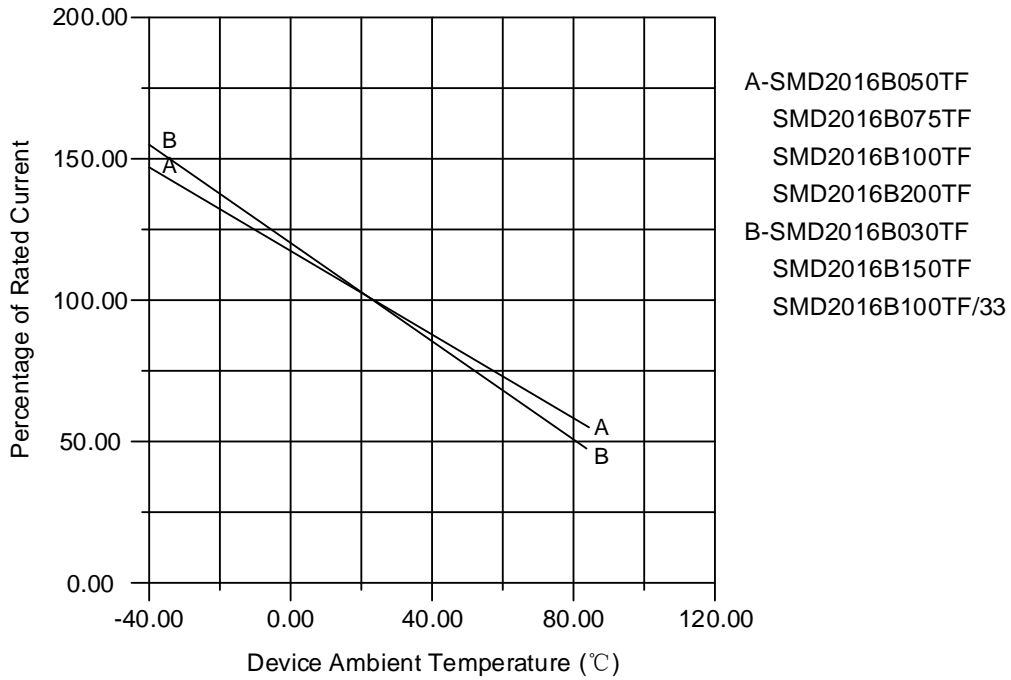

Thermal Derating Chart

Recommended Hold Current (A) at Ambient Temperature (°C)

Part Number	Ambient Operation Temperature								
	-40°C	-20°C	0°C	23°C	40°C	50°C	60°C	70°C	85°C
SMD2016B030TF	0.45	0.40	0.35	0.30	0.25	0.23	0.20	0.18	0.14
SMD2016B050TF	0.93	0.80	0.65	0.50	0.42	0.38	0.33	0.30	0.23
SMD2016B075TF	1.05	0.95	0.85	0.75	0.60	0.55	0.45	0.40	0.30
SMD2016B100TF	1.66	1.47	1.29	1.10	0.91	0.83	0.73	0.64	0.50
SMD2016B100TF/33	1.66	1.47	1.29	1.10	0.91	0.83	0.73	0.64	0.50
SMD2016B150TF	2.26	2.00	1.76	1.50	1.24	1.13	1.00	0.87	0.68
SMD2016B150TF/33	2.26	2.00	1.76	1.50	1.24	1.13	1.00	0.87	0.68
SMD2016B200TF	2.80	2.50	2.19	2.00	1.84	1.74	1.50	1.34	1.14
SMD2016B260TF/24	3.82	3.46	3.06	2.60	2.24	2.03	1.82	1.60	1.26
SMD2016B300TF	4.40	3.96	3.52	3.00	2.65	2.43	2.20	1.96	1.59
SMD2016B500TF	7.29	6.57	5.86	5.00	4.38	4.02	3.66	3.26	2.66

Average Time-Current Curve

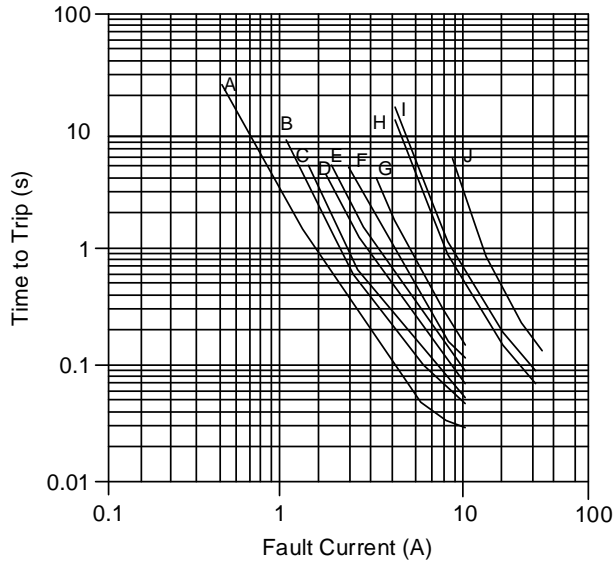

- A-SMD2016B030TF
- B-SMD2016B050TF
- C-SMD2016B075TF
- D-SMD2016B100TF
- SMD2016B100TF/33
- F-SMD2016B150TF
- SMD2016B150TF/33
- G-SMD2016B200TF
- H- SMD2016B260TF/24
- I- SMD2016B300TF
- J- SMD2016B500TF

Soldering Parameters

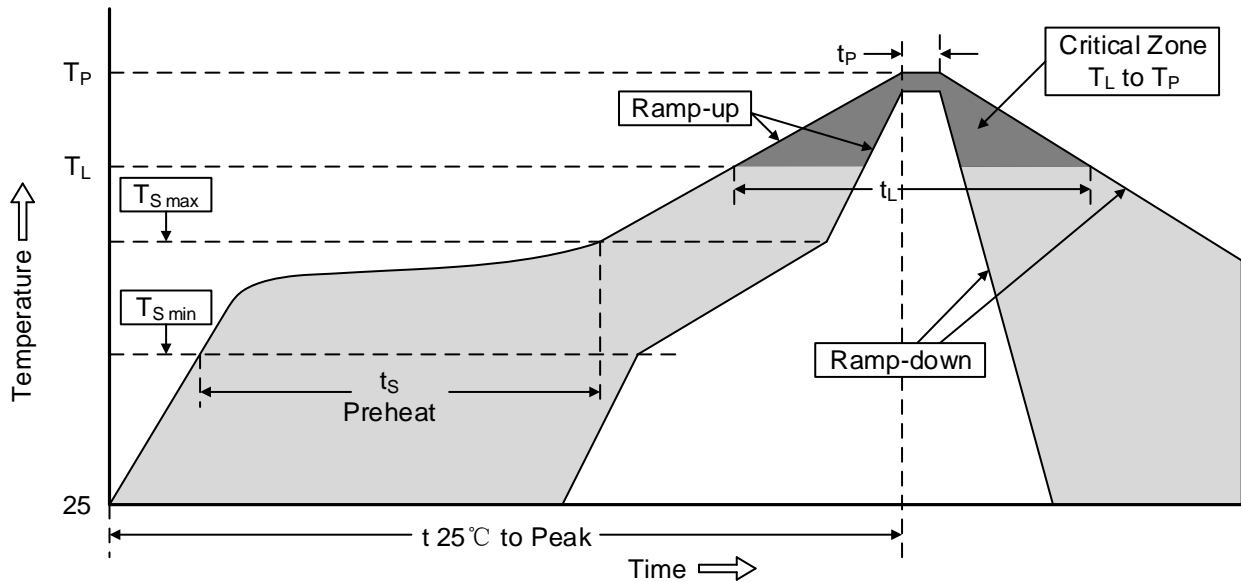

Profile Feature	Pb-Free Assembly
Average ramp-up rate ($T_{S\ max}$ to T_P)	3°C/second max.
Preheat	
-Temperature Min ($T_{S\ min}$)	150°C
-Temperature Max ($T_{S\ max}$)	200°C
-Time (min to max) ($T_{S\ min}$ to $T_{S\ max}$)	60-180 seconds
Time maintained above:	
-Temperature (T_L)	217°C
-Time (t_L)	60-150 seconds
Peak Temperature (T_P)	260°C
Time within 5°C of actual Peak Temperature (t_P)	20-40 seconds

Profile Feature	Pb-Free Assembly
Ramp-down Rate	6°C/second max.
Time 25°C to Peak Temperature	8 minutes max.
Storage Condition	0°C~35°C, ≤70%RH

- Recommended reflow methods: IR, vapor phase oven, hot air oven, N₂ environment for lead-free
- Recommended maximum paste thickness is 0.25mm (0.010 inch)
- Device can be cleaned using standard industry methods and solvents.

Note 1: All temperature refer to topside of the package, measured on the package body surface.

Note 2: If reflow temperatures exceed the recommended profile, devices may not meet the performance requirements.

Environmental Specifications

Operating / Storage temperature	-40°C to +85°C
Maximum Device Surface Temperature in Tripped State	125°C
Passive Aging	+85°C, 1000 hours ±50% typical resistance change
Humidity Aging	+85°C, 85%R.H. 1000 hours ±50% typical resistance change
Thermal Shock	MIL-STD-202, Method 107G +85°C/-40°C 20 times -50% typical resistance change
Solvent Resistance	MIL-STD-202, Method 215 No change
Vibration	MIL-STD-883C, Method 2007.1, Condition A No change
Moisture Level Sensitivity	Level 1, J-STD-020C

Physical Specifications

Terminal Material	Solder-Plated Copper (Solder Material: Matte Tin (Sn))
Terminal Solderability	Meets EIA Specification RS186-9E, ANSI/J-STD-002 Category 3.

Packaging

Part Number	Quantity	Part Number	Quantity
SMD2016B030TF	1500	SMD2016B150TF/33	1500
SMD2016B050TF	1000	SMD2016B200TF	2000
SMD2016B075TF	800	SMD2016B260TF/24	1000
SMD2016B100TF	2000	SMD2016B300TF	1000
SMD2016B100TF/33	1500	SMD2016B500TF	1000
SMD2016B150TF	1500		

© 8mm tape on 7 inch reel per EIA-481 (equivalent to IEC286, part 3)

Tape

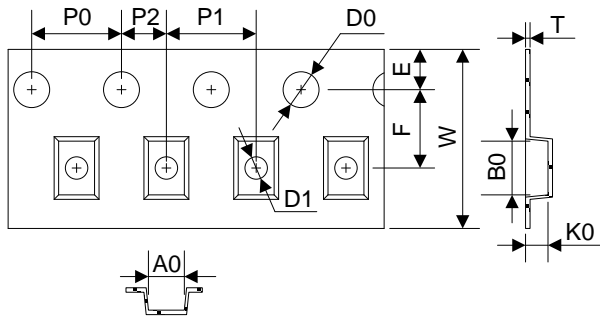

Symbol	Dimensions (mm)			
	B100TF B200TF	B030TF B150TF B100TF/33 B150TF/33	B050TF B260TF/24 B300TF B500TF	B075TF
W	12.0±0.30	12.0±0.30	12.0±0.30	12.0±0.30
F	5.50±0.05	5.50±0.05	5.50±0.05	5.50±0.10
E ₁	1.75±0.10	1.75±0.10	1.75±0.10	1.75±0.10
D ₀	1.55±0.05	1.55±0.05	1.55±0.05	1.50±0.10
D ₁	1.50(MIN)	1.50±0.10	1.50±0.10	1.50±0.10
P ₀	4.00±0.10	4.00±0.10	4.00±0.10	4.00±0.10
P ₁	8.00±0.10	8.00±0.10	8.00±0.10	8.00±0.10
P ₂	2.00±0.05	2.00±0.05	2.00±0.05	2.00±0.10
A ₀	4.40±0.10	4.48±0.10	4.45±0.10	4.51±0.10
B ₀	5.50±0.10	5.40±0.10	5.48±0.10	5.50±0.10
T	0.25±0.10	0.25±0.10	0.25±0.10	0.30±0.10
K ₀	0.75±0.10	1.36±0.10	1.86±0.10	2.40±0.10
Leader min.	390	390	390	390
Trailer min.	160	160	160	160

Reel

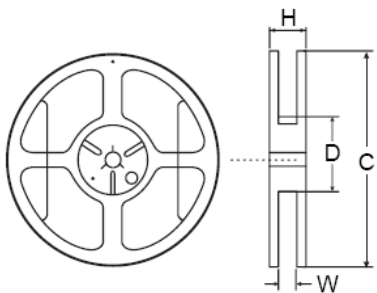

C	Φ178.0±1.0
D	Φ60.2±0.5
H	16.0±0.5
W	13.2±1.5

LEGAL DISCLAIMER

YAGEO, its distributors and agents (collectively, "YAGEO"), hereby disclaims any and all liabilities for any errors, inaccuracies or incompleteness contained in any product related information, including but not limited to product specifications, datasheets, pictures and/or graphics. YAGEO may make changes, modifications and/or improvements to product related information at any time and without notice.



YAGEO makes no representation, warranty, and/or guarantee about the fitness of its products for any particular purpose or the continuing production of any of its products. To the maximum extent permitted by law, YAGEO disclaims (i) any and all liability arising out of the application or use of any YAGEO product, (ii) any and all liability, including without limitation special, consequential or incidental damages, and (iii) any and all implied warranties, including warranties of fitness for a particular purpose, non-infringement and merchantability.

YAGEO products are designed for general purpose applications under normal operation and usage conditions. Please contact YAGEO for the applications listed below which require especially high reliability for the prevention of defects which might directly cause damage to the third party's life, body or property: Aerospace equipment (artificial satellite, rocket, etc.), Atomic energy-related equipment, Aviation equipment, Disaster prevention equipment, crime prevention equipment, Electric heating apparatus, burning equipment, Highly public information network equipment, data-processing equipment, Medical devices, Military equipment, Power generation control equipment, Safety equipment, Traffic signal equipment, Transportation equipment and Undersea equipment, or for any other application or use in which the failure of YAGEO products could result in personal injury or death, or serious property damage. Particularly **YAGEO Corporation and its affiliates do not recommend the use of commercial or automotive grade products for high reliability applications or manned space flight.**

Information provided here is intended to indicate product specifications only. YAGEO reserves all the rights for revising this content without further notification, as long as products are unchanged. Any product change will be announced by PCN.

Looking for pricing, stock, or lifecycle information?

Click below to explore more details on WIN SOURCE:

-  [View SMD2016B050TF on WIN SOURCE](#)
-  [Yageo Information](#)

Optimize Your Supply Chain with WIN SOURCE Solutions

-  Global Sourcing Solution
-  Obsolete Management
-  Cost Control Management
-  Shortage Management
-  Alternative Solution
-  Excess Inventory Management