



H-Bridge Motor Driver/Amplifiers

FEATURES

- ◆ LOW COST COMPLETE H-BRIDGE
- ◆ SELF-CONTAINED SMART LOWSIDE/
HIGHSIDE DRIVE CIRCUITRY
- ◆ WIDE SUPPLY RANGE: UP TO 80V
- ◆ 10A CONTINUOUS OUTPUT
- ◆ ISOLATED CASE ALLOWS DIRECT
HEATSINKING
- ◆ FOUR QUADRANT OPERATION, TORQUE
CONTROL CAPABILITY
- ◆ INTERNAL/PROGRAMMABLE PWM
FREQUENCY GENERATION

APPLICATIONS

- ◆ BRUSH TYPE MOTOR CONTROL
- ◆ CLASS D SWITCHMODE AMPLIFIER
- ◆ REACTIVE LOADS
- ◆ MAGNETIC COILS (MRI)
- ◆ ACTIVE MAGNETIC BEARING
- ◆ VIBRATION CANCELLING

DESCRIPTION

The SA60 is a pulse width modulation amplifier that can supply 10A continuous current to the load. The full bridge amplifier can be operated over a wide range of supply voltages. All of the drive/control circuitry for the lowside and highside switches are internal to the hybrid. The PWM circuitry is internal as well, leaving the user to only provide an analog signal for the motor speed/direction, or audio signal for switchmode audio amplification. The internal PWM frequency can be programmed by an external integrator capacitor. Alternatively, the user may provide an external TTL-compatible PWM signal for simultaneous amplitude and direction control for four quadrant mode.

BLOCK DIAGRAM

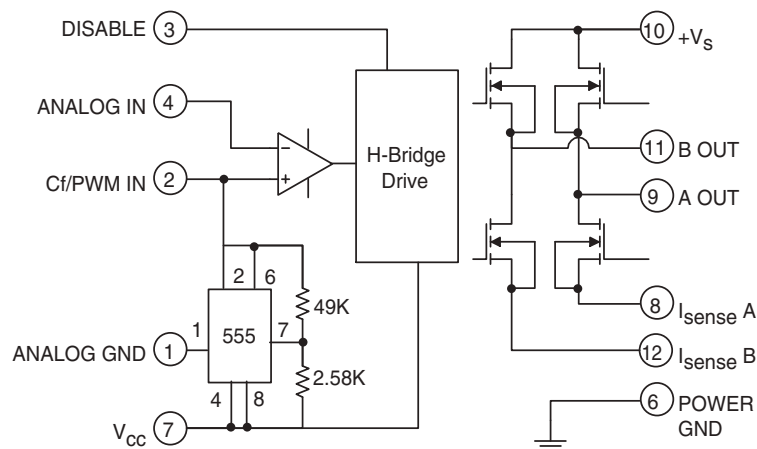

1. CHARACTERISTICS AND SPECIFICATIONS

ABSOLUTE MAXIMUM RATINGS

Parameter	Symbol	Min	Max	Units
SUPPLY VOLTAGE, $+V_S$ (Note 4)			80	V
OUTPUT CURRENT, peak			15	A
LOGIC SUPPLY VOLTAGE, V_{CC}			16	V
POWER DISSIPATION, internal (Note 3)			156	W
TEMPERATURE, pin solder, 10s max.			260	°C
TEMPERATURE, junction (Note 2)			150	°C
TEMPERATURE RANGE, storage		-55	125	°C
OPERATING TEMPERATURE RANGE, case		-40	85	°C

CAUTION

The SA60 is constructed from MOSFET transistors. ESD handling procedures must be observed. The exposed substrate contains beryllia (BeO). Do not crush, machine, or subject to temperatures in excess of 850°C to avoid generating toxic fumes.

SPECIFICATIONS

Parameter	Test Conditions ¹	Min	Typ	Max	Units
INPUT					
ANALOG INPUT VOLTAGES	$V_{CC} = 12V$				
A, B OUT = 50% Duty Cycle			$1/2 V_{CC}$		VDC
A OUT = 100% Duty Cycle High			$1/3 V_{CC}$		VDC
B OUT = 100% Duty Cycle High			$2/3 V_{CC}$		VDC
PWM INPUT					
PWM PULSE LOW VOLTAGE		0		0.8	VDC
PWM PULSE HIGH VOLTAGE		2.7		5.0	VDC
PWM FREQUENCY			45	250	KHz
DISABLE ON		2.7		V_{CC}	VDC
DISABLE OFF		0		0.8	VDC
OUTPUT					
V_{DS} (ON) VOLTAGE, each MOSFET	$I_{DS} = 10A$		1.7	2.5	VDC
TOTAL R_{ON} , both MOSFETs				0.45	Ω
EFFICIENCY, 10A OUTPUT	$+V_S = 80A$		91		%
CURRENT, continuous		10			A
CURRENT, peak	$t = 100$ msec	15			A
SWITCHING FREQUENCY	$C_F = 270pF$		45		KHz
DEAD TIME			90		nS
POWER SUPPLY					
$+V_S$ VOLTAGE (Note 4)	$+V_S$ Current = Load Current			80	VDC
V_{CC} VOLTAGE		9.5	12	15	VDC
V_{CC} CURRENT	$V_{CC} = 12VDC$		28	36	mA
$+V_S$ CURRENT	Switching Freq. = 45kHz, no load, $V_S = 50V$		45		mA

Parameter	Test Conditions ¹	Min	Typ	Max	Units
THERMAL (Note 3)					
RESISTANCE, junction to case	Full temperature range, for each transistor			1.6	°C/W
RESISTANCE, junction to air	Full temperature range		30		°C/W
TEMPERATURE RANGE, case		-25		+85	°C

- NOTES: 1. (All Min/Max characteristics and specifications are guaranteed over the Specified Operating Conditions. Typical performance characteristics and specifications are derived from measurements taken at typical supply voltages and $T_C = 25^\circ\text{C}$, $V_{CC} = 12\text{VDC}$).
2. Long term operation at the maximum junction temperature will result in reduced product life. Derate power dissipation to achieve high MTTF.
3. Each of the two active output transistors can dissipate 78W.
4. Derate to 70V below $T_C = +25^\circ\text{C}$.

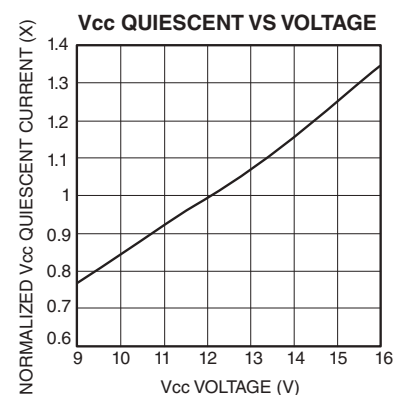
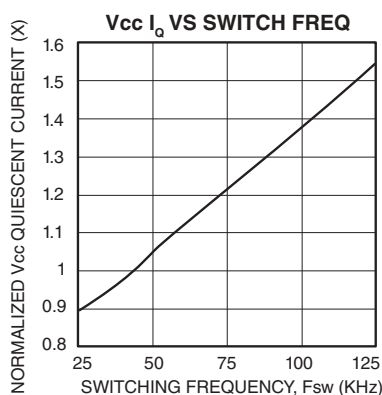
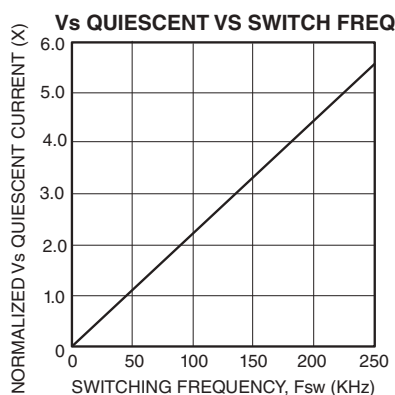
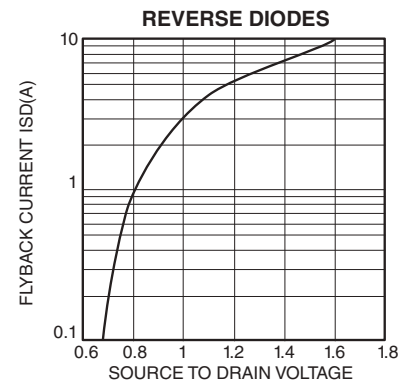
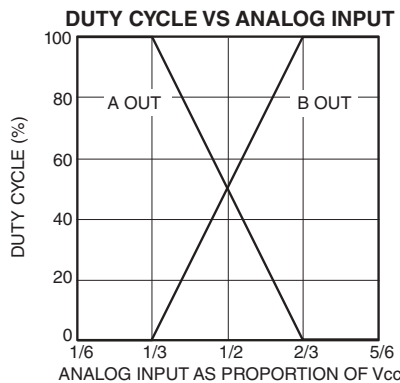
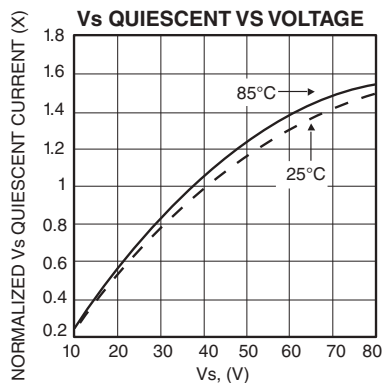
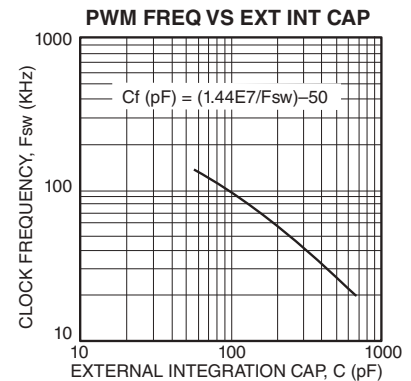
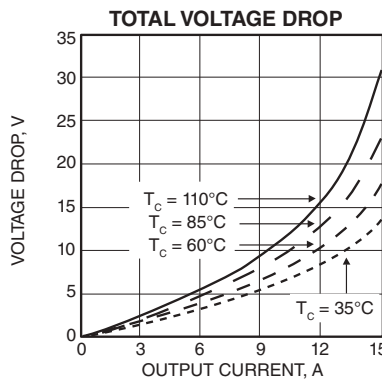
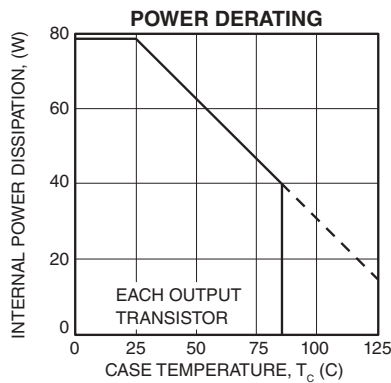

EXTERNAL CONNECTIONS

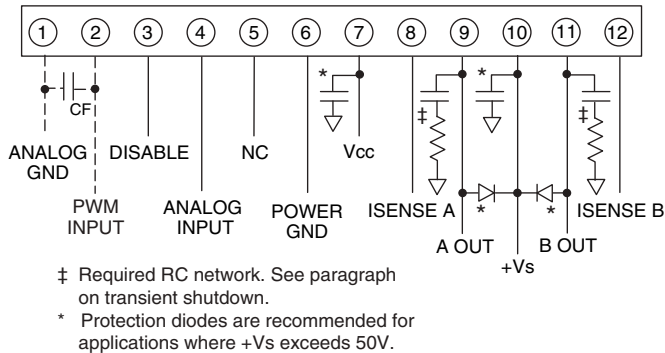

12-pin Power SIP PACKAGE STYLE DP

Formed Leads Available
 See package style EE

TYPICAL APPLICATION

A wide variety of loads can be driven in either the voltage mode or the current mode. The most common applications use three external blocks: a low pass filter converting pulse width data to an analog output, a difference amplifier to monitor voltage or current and an error amplifier. Filter inductors must be suitable for square waves at the switching frequency (laminated steel is generally not acceptable). Filter capacitors must be low ESR and rated for the expected ripple current. A difference amplifier with gain of less than one translates the differential output voltage to a single feedback voltage. Dashed line connections and a higher gain difference amplifier would be used for current control. The error amplifier integrates the difference between the input and feedback voltages to close the loop.

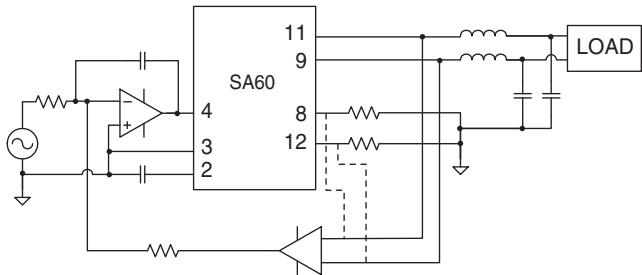

GENERAL

Please read Application Note 30 on "PWM Basics". Refer to Application Note 1 "General Operating Considerations" for helpful information regarding power supplies, heat sinking and mounting. Visit www.apexanalog.com for design tools that help automate pwm filter design; heat sink selection; Apex Microtechnology's complete Application Notes library; Technical Seminar Workbook; and Evaluation Kits.

PWM OSCILLATOR – INTERNAL OR EXTERNAL

The SA60 contains an internal PWM oscillator whose frequency is determined by an external capacitor connected between pin 1 and pin 2. Maximum frequency is 125 kHz. The user may also disregard the internal PWM oscillator and supply the SA60 with an external TTL pulse generator up to 250KHZ.

PIN DESCRIPTION

V_{CC} - is the low voltage supply for powering internal logic and drivers for the lowside and highside MOSFETS. The supplies for the highside drivers are derived from this voltage.

V_S - is the higher voltage H-bridge supply. The MOSFETS obtain the output current from this supply pin. The voltage on this pin is limited to +80V by the drive IC. The MOSFETS are rated at 100 volts.

ISENSE A & B - These are tied to power gnd directly or through sense resistors.

ANALOG GND - is the reference for the internal PWM oscillator. Connect this pin to pin 6. Connect low side of V_{CC} supply and any other supply used to generate analog input signals to ANALOG GND.

ANALOG INPUT - is an analog input for controlling the PWM pulse width of the bridge. A voltage higher than V_{CC}/2 will produce greater than 50% duty cycle pulses out of B OUT. A voltage lower than V_{CC}/2 will produce greater than 50% duty cycle pulses out of A OUT. If using in the digital mode, bias this point at 1/2 the logic high level.

DISABLE - Is the connection for disabling all 4 output switches. DISABLE high overrides all other inputs. When taken low, everything functions normally. An internal pullup to V_{CC} will keep DISABLE high if pin left open.

PWM INPUT - Is the TTL compatible digital input for controlling the PWM pulse width of the bridge. A duty cycle greater than 50% will produce greater than 50% duty cycle pulses out of the A out. A duty cycle less than 50% will produce greater than 50% duty cycle from the B out. For analog inputs, the integration capacitor for the internal clock must be connected between this pin and analog ground. The internal switching frequency is programmable up to 125 kHz by selection of the integration capacitor. The formula is:

$$C_F (\mu\text{F}) = \left(\frac{1.44 \times 10^7}{F_{sw}} \right) - 50$$

BYPASSING

Adequate bypassing of the power supplies is required for proper operation. Failure to do so can cause erratic and low efficiency operation as well as excessive ringing at the outputs. The V_s supply should be bypassed with at least a 1 μF ceramic capacitor in parallel with another low ESR capacitor of at least 10 μF per amp of output current. Capacitor types rated for switching applications are the only types that should be considered. The 1 μF ceramic capacitor must be physically connected directly to the V_s and POWER GND pins. Even one inch of lead length will cause excessive ringing at the outputs. This is due to the very fast switching times and the inductance of the lead connection. The bypassing requirements of the V_{cc} supply are less stringent, but still necessary. A .1 μF to .47 μF ceramic capacitor connected directly to the V_{cc} and ANALOG GND pins will suffice.

PCB LAYOUT

The designer needs to appreciate that the SA60 combines in one circuit both high speed high power switching and low level analog signals. Certain layout rules of thumb must be considered when a circuit board layout is designed using the SA60:

1. Bypassing of the power supplies is critical. Capacitors must be connected directly to the power supply pins with very short lead lengths (well under 1 inch). Ceramic chip capacitors are best.
2. Connect ANALOG GND to POWER GND with a conductor having no intermediate connections. Connect all V_s power supply, filter and load related ground connections to POWER GND keeping these conductors separate until reaching pin 6. Connect all V_{cc} power supply and input signal related ground connections to ANALOG GND keeping conductors separate until reaching pin 1. Do not allow ground loops to form by making additional ground connections at the low side of the physical power supplies. If ground plane is used do not allow more than 1mA to flow through it.
3. Beware of capacitive coupling between output connections and signal inputs through the parasitic capacitance between layers in multilayer PCB designs.
4. Do not run small signal traces between the pins of the output section (pins 8-12).

CURRENT SENSE

There are two load current sensing pins, I SENSE A and I SENSE B. The two pins can be shorted to POWER GND in the voltage mode connection but both must be used in the current mode connection. It is recommended that R SENSE resistors be non-inductive. Load current flows in the I SENSE pins. The SA60 has no internal current limit.

TRANSIENT SUPPRESSION

An RC network of a 100 pF Capacitor and a one ohm resistor is required as shown in the external connection diagram on page 1. This network assures proper operation under various loads. Minimal power is dissipated in the resistor.

NEED TECHNICAL HELP? CONTACT APEX SUPPORT!

For all Apex Microtechnology product questions and inquiries, call toll free 800-546-2739 in North America.

For inquiries via email, please contact apex.support@apexanalog.com.

International customers can also request support by contacting their local Apex Microtechnology Sales Representative.

To find the one nearest to you, go to www.apexanalog.com

IMPORTANT NOTICE



Apex Microtechnology, Inc. has made every effort to insure the accuracy of the content contained in this document. However, the information is subject to change without notice and is provided "AS IS" without warranty of any kind (expressed or implied). Apex Microtechnology reserves the right to make changes without further notice to any specifications or products mentioned herein to improve reliability. This document is the property of Apex Microtechnology and by furnishing this information, Apex Microtechnology grants no license, expressed or implied under any patents, mask work rights, copyrights, trademarks, trade secrets or other intellectual property rights. Apex Microtechnology owns the copyrights associated with the information contained herein and gives consent for copies to be made of the information only for use within your organization with respect to Apex Microtechnology integrated circuits or other products of Apex Microtechnology. This consent does not extend to other copying such as copying for general distribution, advertising or promotional purposes, or for creating any work for resale.

APEX MICROTECHNOLOGY PRODUCTS ARE NOT DESIGNED, AUTHORIZED OR WARRANTED TO BE SUITABLE FOR USE IN PRODUCTS USED FOR LIFE SUPPORT, AUTOMOTIVE SAFETY, SECURITY DEVICES, OR OTHER CRITICAL APPLICATIONS. PRODUCTS IN SUCH APPLICATIONS ARE UNDERSTOOD TO BE FULLY AT THE CUSTOMER OR THE CUSTOMER'S RISK.

Apex Microtechnology, Apex and Apex Precision Power are trademarks of Apex Microtechnology, Inc. All other corporate names noted herein may be trademarks of their respective holders.

Looking for pricing, stock, or lifecycle information?

Click below to explore more details on WIN SOURCE:

-  [View SA60 on WIN SOURCE](#)
-  [Apex Microtechnology Information](#)

Optimize Your Supply Chain with WIN SOURCE Solutions

-  Global Sourcing Solution
-  Obsolete Management
-  Cost Control Management
-  Shortage Management
-  Alternative Solution
-  Excess Inventory Management