



**THE DATASHEET OF  
S2055R**



Sxx55x Series



**Description**

Excellent unidirectional switches for phase control applications such as heating and motor speed controls. Standard phase control SCRs are triggered with few milliamperes of current at less than 1.5V potential.

**Features & Benefits**

- RoHS-compliant
- Glass – passivated junctions
- Voltage capability up to 1000 V
- Surge capability up to 650 A

**Applications**

Typical applications are AC solid-state switches, industrial power tools, exercise equipment, white goods and commercial appliances.

**Main Features**

Symbol	Value	Unit
$I_{T(RMS)}$	55	A
$V_{DRM}/V_{RRM}$	400 to 1000	V
$I_{GT}$	40	mA

**Additional Information**



Datasheet

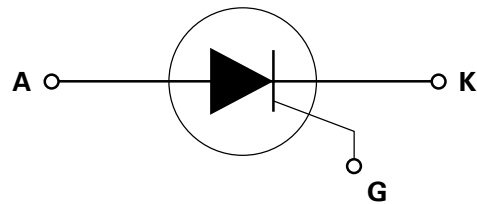


Resources



Samples

**Schematic Symbol**



**Absolute Maximum Ratings**

Symbol	Parameter	Test Conditions	Value	Unit
$I_{T(RMS)}$	RMS on-state current	$T_c = 90^\circ\text{C}$	55	A
$I_{T(AV)}$	Average on-state current	$T_c = 90^\circ\text{C}$	35.0	A
$I_{TSM}$	Peak non-repetitive surge current	single half cycle; $f = 50\text{Hz}$ ; $T_j(\text{initial}) = 25^\circ\text{C}$	550	A
		single half cycle; $f = 60\text{Hz}$ ; $T_j(\text{initial}) = 25^\circ\text{C}$	650	
$I^2t$	$I^2t$ Value for fusing	$t_p = 8.3 \text{ ms}$	1750	$\text{A}^2\text{s}$
$di/dt$	Critical rate of rise of on-state current	$f = 60\text{Hz}$ ; $T_j = 125^\circ\text{C}$	175	$\text{A}/\mu\text{s}$
$I_{GM}$	Peak gate current	$T_j = 125^\circ\text{C}$ $P_w = 10\mu\text{S}$	4.0	A
$P_{G(AV)}$	Average gate power dissipation	$T_j = 125^\circ\text{C}$	0.8	W
$T_{stg}$	Storage temperature range		-40 to 150	$^\circ\text{C}$
$T_j$	Operating junction temperature range		-40 to 125	$^\circ\text{C}$

### Electrical Characteristics ( $T_J = 25^\circ\text{C}$ , unless otherwise specified)

Symbol	Test Conditions			Value	Unit
$I_{GT}$	$V_D = 12\text{V}; R_L = 30\ \Omega$		MAX.	40	mA
			MIN.	5	
$V_{GT}$	$V_D = 12\text{V}; R_L = 30\ \Omega$		MAX.	1.5	V
$dv/dt$	$V_D = V_{DRM}; \text{gate open}; T_J = 100^\circ\text{C}$	400V	MIN.	650	V/ $\mu\text{s}$
		600V		600	
		800V		500	
	$V_D = V_{DRM}; \text{gate open}; T_J = 125^\circ\text{C}$	1000V		250	
		400V		550	
		600V		500	
	800V	475			
$V_{GD}$	$V_D = V_{DRM}; R_L = 3.3\ \text{k}\Omega; T_J = 125^\circ\text{C}$		MIN.	0.2	V
$I_H$	$I_T = 400\text{mA}$ (initial)		MAX.	60	mA
$t_q$	(1)		MAX.	35	$\mu\text{s}$
$t_{gt}$	$I_G = 2 \times I_{GT}; \text{PW} = 15\ \mu\text{s}; I_T = 110\text{A}$		TYP.	2.5	$\mu\text{s}$

**Note :**

(1)  $I_T = 2\text{A}; t_p = 50\ \mu\text{s}; dv/dt = 5\text{V}/\mu\text{s}; di/dt = 30\text{A}/\mu\text{s}$

### Static Characteristics

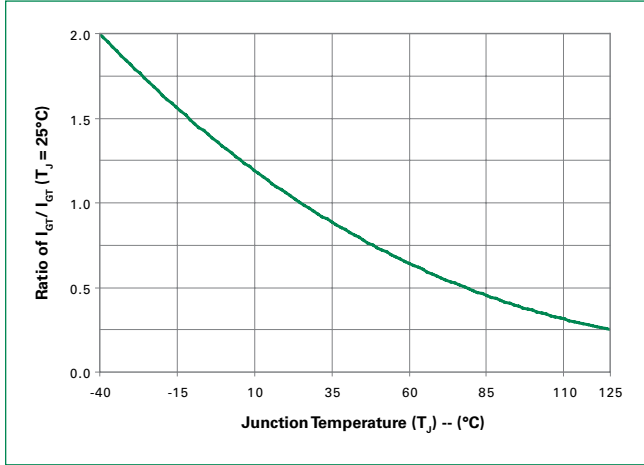
Symbol	Test Conditions			Value	Unit
$V_{TM}$	$I_T = 110\text{A}; t_p = 380\ \mu\text{s}$		MAX.	1.8	V
$I_{DRM} / I_{RRM}$	$V_{DRM} / V_{RRM}$	$T_J = 25^\circ\text{C}$	MAX.	400 – 600V	10
				800V	20
				1000V	30
		$T_J = 100^\circ\text{C}$		400 – 600V	1000
				800V	1500
				1000V	5000
		$T_J = 125^\circ\text{C}$		400 – 600V	2000
				800V	3000

### Thermal Resistances

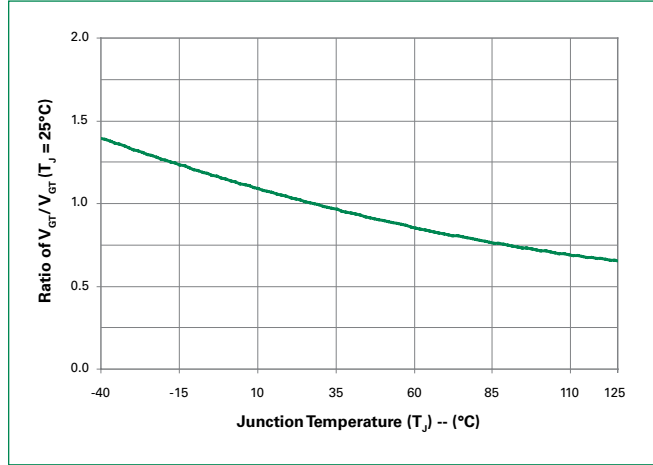
Symbol	Parameter		Value	Unit
$R_{\theta(J-C)}$	Junction to case (AC)	Sxx55R Sxx55N	0.5	$^\circ\text{C}/\text{W}$
		Sxx55W Sxx55M	0.53	
$R_{\theta(J-A)}$	Junction to ambient	Sxx55R	40	$^\circ\text{C}/\text{W}$

**Note:** xx = voltage

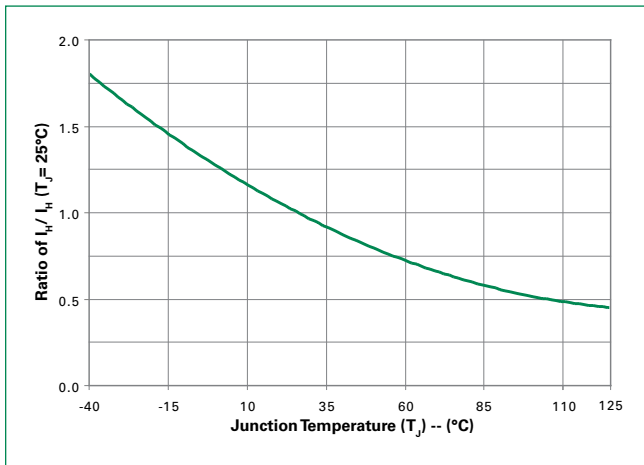
**Figure 1: Normalized DC Gate Trigger Current vs. Junction Temperature**



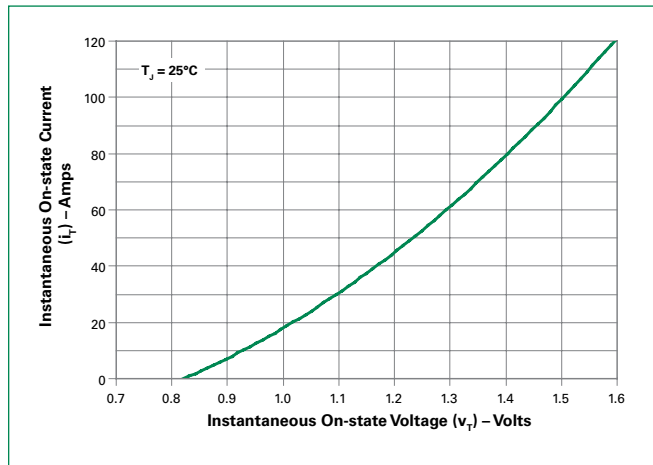
**Figure 2: Normalized DC Gate Trigger Voltage vs. Junction Temperature**



**Figure 3: Normalized DC Holding Current vs. Junction Temperature**



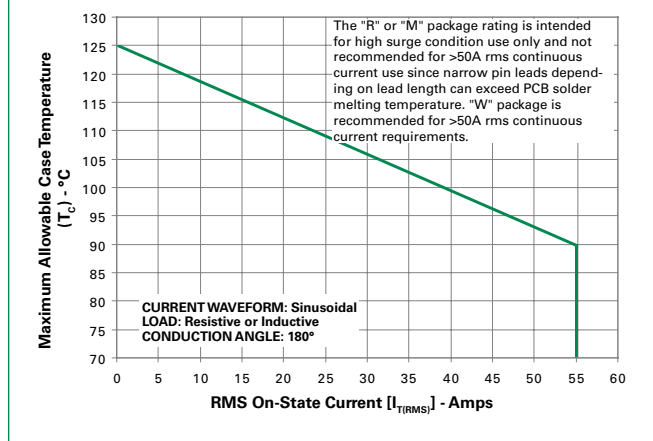
**Figure 4: On-State Current vs. On-State Voltage (Typical)**



**Figure 5: Power Dissipation (Typical) vs. RMS On-State Current**

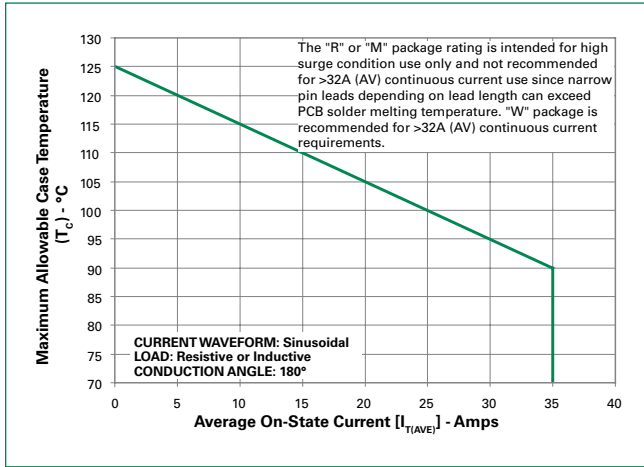


**Figure 6: Maximum Allowable Case Temperature vs. RMS On-State Current**

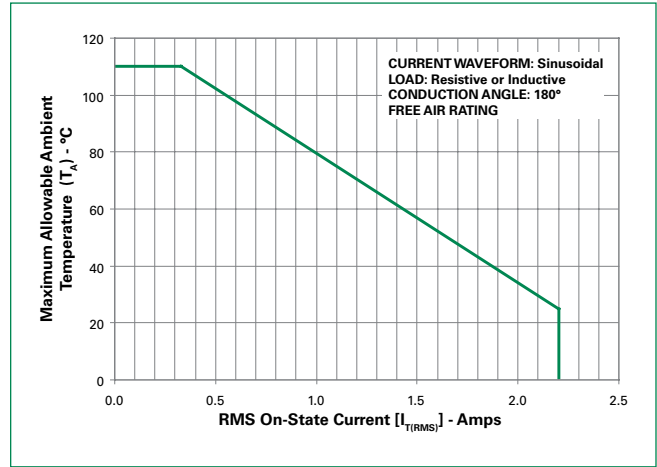


Note: xx = voltage

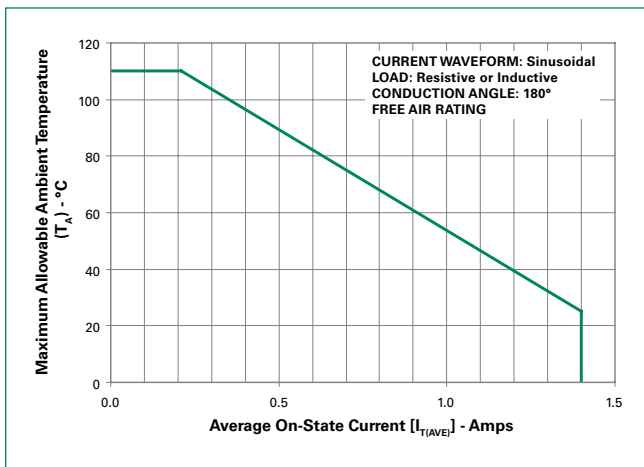
**Figure 7: Maximum Allowable Case Temperature vs. Average On-State Current**



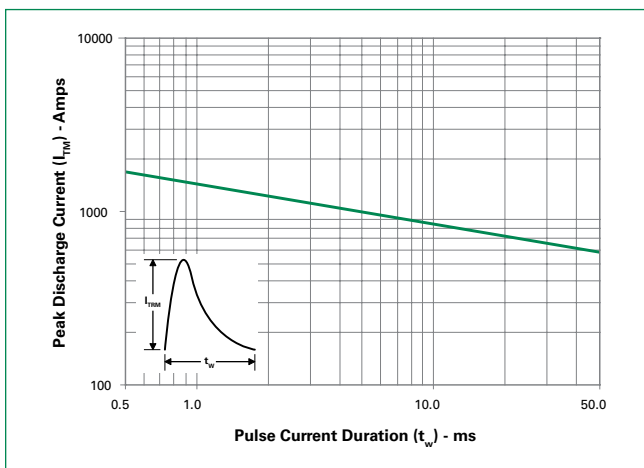
**Figure 8: Maximum Allowable Ambient Temperature vs. RMS On-State Current**



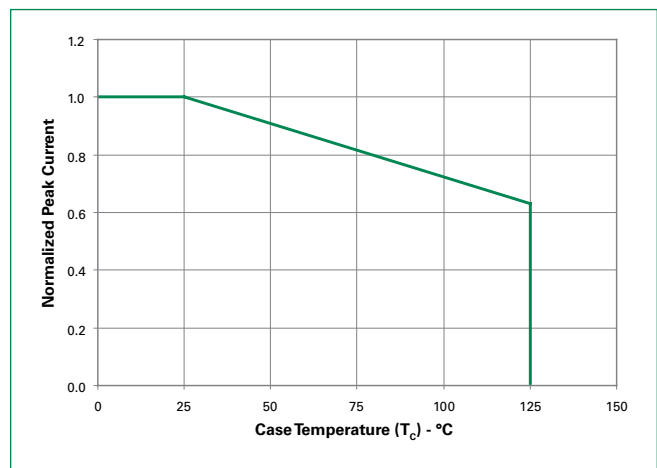
**Figure 9: Maximum Allowable Ambient Temperature vs. Average On-State Current**



**Figure 10: Peak Capacitor Discharge Current**



**Figure 11: Peak Capacitor Discharge Current Derating**



Note: xx = voltage

**Figure 12: Surge Peak On-State Current vs. Number of Cycles**



**Soldering Parameters**

<b>Reflow Condition</b>		Pb – Free assembly
<b>Pre Heat</b>	- Temperature Min ( $T_{s(min)}$ )	150°C
	- Temperature Max ( $T_{s(max)}$ )	200°C
	- Time (min to max) ( $t_s$ )	60 – 180 secs
<b>Average ramp up rate (Liquidus Temp) (<math>T_L</math>) to peak</b>		5°C/second max
<b><math>T_{s(max)}</math> to <math>T_L</math> - Ramp-up Rate</b>		5°C/second max
<b>Reflow</b>	- Temperature ( $T_L$ ) (Liquidus)	217°C
	- Temperature ( $t_L$ )	60 – 150 seconds
<b>Peak Temperature (<math>T_p</math>)</b>		260 <sup>+0/-5</sup> °C
<b>Time within 5°C of actual peak Temperature (<math>t_p</math>)</b>		20 – 40 seconds
<b>Ramp-down Rate</b>		5°C/second max
<b>Time 25°C to peak Temperature (<math>T_p</math>)</b>		8 minutes Max.
<b>Do not exceed</b>		280°C



**Physical Specifications**

<b>Terminal Finish</b>	100% Matte Tin-plated
<b>Body Material</b>	UL recognized epoxy meeting flammability classification 94V-0
<b>Lead Material</b>	Copper Alloy

**Design Considerations**

Careful selection of the correct device for the application's operating parameters and environment will go a long way toward extending the operating life of the Thyristor. Good design practice should limit the maximum continuous current through the main terminals to 75% of the device rating. Other ways to ensure long life for a power discrete semiconductor are proper heat sinking and selection of voltage ratings for worst case conditions. Overheating, overvoltage (including dv/dt), and surge currents are the main killers of semiconductors. Correct mounting, soldering, and forming of the leads also help protect against component damage.

**Environmental Specifications**

Test	Specifications and Conditions
<b>AC Blocking</b>	MIL-STD-750, M-1040, Cond A Applied Peak AC voltage @ 125°C for 1008 hours
<b>Temperature Cycling</b>	MIL-STD-750, M-1051, 100 cycles; -40°C to +150°C; 15-min dwell-time
<b>Temperature/Humidity</b>	EIA / JEDEC, JESD22-A101 1008 hours; 320V - DC: 85°C; 85% rel humidity
<b>High Temp Storage</b>	MIL-STD-750, M-1031, 1008 hours; 150°C
<b>Low-Temp Storage</b>	1008 hours; -40°C
<b>Resistance to Solder Heat</b>	MIL-STD-750 Method 2031
<b>Solderability</b>	ANSI/J-STD-002, category 3, Test A
<b>Lead Bend</b>	MIL-STD-750, M-2036 Cond E

**Dimensions – TO-220AB (R-Package) – Non-Isolated Mounting Tab Common with Center Lead**



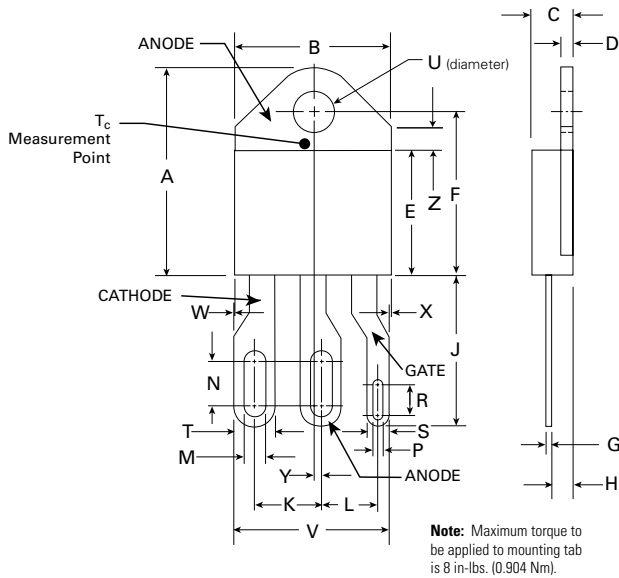
Dimension	Inches		Millimeters	
	Min	Max	Min	Max
<b>A</b>	0.380	0.420	9.65	10.67
<b>B</b>	0.105	0.115	2.67	2.92
<b>C</b>	0.230	0.250	5.84	6.35
<b>D</b>	0.590	0.620	14.99	15.75
<b>E</b>	0.142	0.147	3.61	3.73
<b>F</b>	0.110	0.130	2.79	3.30
<b>G</b>	0.540	0.575	13.72	14.61
<b>H</b>	0.025	0.035	0.64	0.89
<b>J</b>	0.195	0.205	4.95	5.21
<b>K</b>	0.095	0.105	2.41	2.67
<b>L</b>	0.060	0.075	1.52	1.91
<b>M</b>	0.085	0.095	2.16	2.41
<b>N</b>	0.018	0.024	0.46	0.61
<b>O</b>	0.178	0.188	4.52	4.78
<b>P</b>	0.045	0.060	1.14	1.52
<b>R</b>	0.038	0.048	0.97	1.22

**Dimensions – TO-263AB (N-package) – D<sup>2</sup>-Pak Surface Mount**



Dimension	Inches		Millimeters	
	Min	Max	Min	Max
A	0.360	0.370	9.14	9.40
B	0.380	0.420	9.65	10.67
C	0.178	0.188	4.52	4.78
D	0.025	0.035	0.63	0.89
E	0.048	0.055	1.22	1.40
F	0.060	0.075	1.52	1.91
G	0.095	0.105	2.41	2.67
H	0.083	0.093	2.11	2.36
J	0.018	0.024	0.46	0.61
K	0.090	0.110	2.29	2.79
S	0.590	0.625	14.99	15.87
V	0.035	0.045	0.89	1.14
U	0.002	0.010	0.05	0.25
W	0.040	0.070	1.02	1.78

**Dimensions – TO-218X (W Package) – Non-Isolated Mounting Tab Common with Center Lead**



Dimension	Inches		Millimeters	
	Min	Max	Min	Max
A	0.810	0.835	20.57	21.21
B	0.610	0.630	15.49	16.00
C	0.178	0.188	4.52	4.78
D	0.055	0.070	1.40	1.78
E	0.487	0.497	12.37	12.62
F	0.635	0.655	16.13	16.64
G	0.022	0.029	0.56	0.74
H	0.075	0.095	1.91	2.41
J	0.575	0.625	14.61	15.88
K	0.256	0.264	6.50	6.71
L	0.220	0.228	5.58	5.79
M	0.080	0.088	2.03	2.24
N	0.169	0.177	4.29	4.49
P	0.034	0.042	0.86	1.07
R	0.113	0.121	2.87	3.07
S	0.086	0.096	2.18	2.44
T	0.156	0.166	3.96	4.22
U	0.164	0.165	4.10	4.20
V	0.603	0.618	15.31	15.70
W	0.000	0.005	0.00	0.13
X	0.003	0.012	0.07	0.30
Y	0.028	0.032	0.71	0.81
Z	0.085	0.095	2.17	2.42

**Dimensions – TO-218AC (M Package) – Non-isolated Mounting Tab Common with Center Lead**



**Note:** Maximum torque to be applied to mounting tab is 8 in-lbs. (0.904 Nm).

Dimension	Inches		Millimeters	
	Min	Max	Min	Max
A	0.810	0.835	20.57	21.21
B	0.610	0.630	15.49	16.00
C	0.178	0.188	4.52	4.78
D	0.055	0.070	1.40	1.78
E	0.487	0.497	12.37	12.62
F	0.635	0.655	16.13	16.64
G	0.022	0.029	0.56	0.74
H	0.075	0.095	1.91	2.41
J	0.575	0.625	14.61	15.88
K	0.211	0.219	5.36	5.56
L	0.422	0.437	10.72	11.10
M	0.058	0.068	1.47	1.73
N	0.045	0.055	1.14	1.40
P	0.095	0.115	2.41	2.92
Q	0.008	0.016	0.20	0.41
R	0.008	0.016	0.20	0.41
U	0.164	0.165	4.10	4.20
W	0.085	0.095	2.17	2.42

**Product Selector**

Part Number	Voltage				Gate Sensitivity	Type	Package
	400V	600V	800V	1000V			
Sxx55R	X	X	X	X	40mA	Standard SCR	TO-220R
Sxx55N	X	X	X	X	40mA	Standard SCR	TO-263
Sxx55W	X	X	X		40mA	Standard SCR	TO-218X
Sxx55M	X	X	X	X	40mA	Standard SCR	TO-218AC

**Note:** xx = Voltage

**Packing Options**

Part Number	Marking	Weight	Packing Mode	Base Quantity
Sxx55RTP	Sxx55R	2.2g	Tube	1000 (50 per tube)
Sxx55NTP	Sxx55N	1.6g	Tube	1000 (50 per tube)
Sxx55NRP	Sxx55N	1.6g	Embossed Carrier	500
Sxx55WTP	Sxx55W	5.23g	Tube	250 (25 per tube)
Sxx55MTP	Sxx55M	4.40g	Tube	250 (25 per tube)

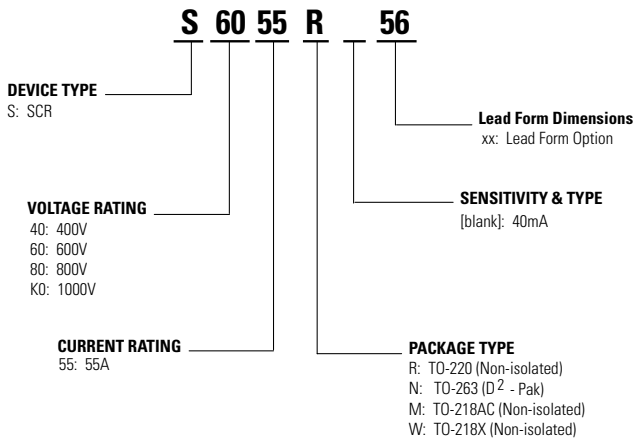
**Note:** xx = Voltage

**TO-263 Embossed Carrier Reel Pack (RP) Specification**

Meets all EIA-481-2 Standards

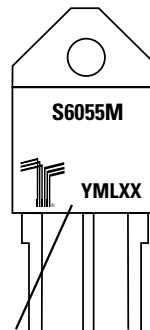


**Part Numbering System**



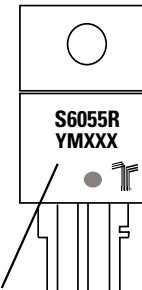
**Part Marking System**

**TO-218AC - (M Package)**  
**TO-218X - (W Package)**



Date Code Marking  
Y: Year Code  
M: Month Code  
L: Location Code  
XX: Lot Serial Code

**TO-220 AB - (R Package)**  
**TO-263 AB - (N Package)**



Date Code Marking  
Y: Year Code  
M: Month Code  
XXX: Lot Trace Code

## Looking for pricing, stock, or lifecycle information?

Click below to explore more details on WIN SOURCE:

 [View S2055R on WIN SOURCE](#)

 [Littelfuse Inc. Information](#)

## Optimize Your Supply Chain with WIN SOURCE Solutions

-  Global Sourcing Solution
-  Obsolete Management
-  Cost Control Management
-  Shortage Management
-  Alternative Solution
-  Excess Inventory Management