



THE DATASHEET OF RT9458WSC



Switch-Mode Single Cell Li-Ion Battery Charger with USB-OTG

General Description

The RT9458 is a switch-mode single cell Li-Ion/Li-Polymer battery charger for portable applications. It integrates a synchronous PWM controller, power MOSFETs, input current sensing, high accuracy voltage regulation and charge termination circuits. The RT9458 also features USB On-The-Go (OTG).

The RT9458 optimizes the charging task by using a control algorithm to vary the charge rate via different modes, including pre-charge mode, fast charge mode, and constant voltage mode. The key charge parameters can be programmed via the I²C interface. The RT9458 resumes the charge cycle whenever the battery voltage falls below an internal threshold and automatically enters sleep mode when the input power supply is removed.

Other features include under-voltage protection, over-voltage protection, thermal regulation and reverse leakage protection.

The RT9458 is available in the small WL-CSP-20B 2.1x1.87 (BSC) package.

Marking Information

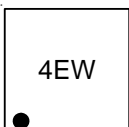

4E : Product Code
W : Date Code

Features

- Support Quick Start for Charger
- High Accuracy Voltage/Current Regulation
- Input Current Regulation : 100mA/500mA/700mA/1A
- Minimum Input Voltage Regulation : 4.1V to 4.7V Per 0.1V Step
- Charge Voltage Regulation Accuracy : ±1% (0 to 85°C)
- Charge Current Regulation Accuracy : ±5%
- Built-In Input Current Sensing and Limiting
- Integrated Power MOSFETS for up to 1.55A Charge Rate
- Integrated Sensing Resistors for Charging Current Sensing
- Synchronous 1.5MHz Fixed Frequency PWM Controller with up to 95% Duty Cycle
- Reverse Leakage Protection to Prevent Battery Drainage
- Thermal Regulation and Protection
- Over-Temperature Protection
- Input Over-Voltage Protection
- IRQ Output for Communication with I²C
- Automatic Charging
- RoHS Compliant and Halogen Free

Applications

- Cellular Telephones
- Personal Information Appliances
- MP3 Players
- Portable Instruments

Simplified Application Circuit

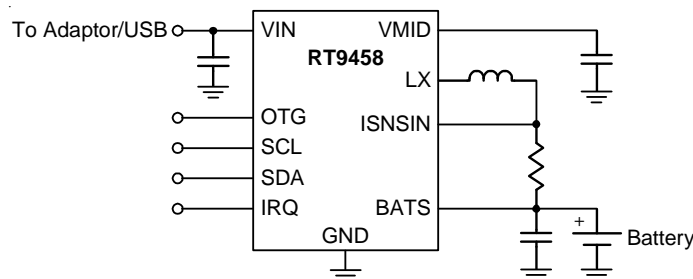

Ordering Information

RT9458□
 Package Type
 WSC : WL-CSP-20B 2.1x1.87 (BSC)

Note :

Richtek products are :

- ▶ RoHS compliant and compatible with the current requirements of IPC/JEDEC J-STD-020.
- ▶ Suitable for use in SnPb or Pb-free soldering processes.

Pin Configuration

(TOP VIEW)

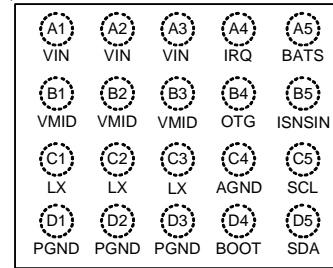

WL-CSP-20B 2.1x1.87 (BSC)

Functional Pin Description

Pin No.	Pin Name	Pin Function
A1, A2, A3	VIN	Power input.
A4	IRQ	IRQ output node. Open-drain output, connect a 10kΩ pull up resistor.
A5	BATS	Feedback voltage input for battery.
B1, B2, B3	VMID	Connection point between reverse blocking MOSFET and high-side MOSFET.
B4	OTG	Boost mode control input or current regulation setting for average input current.
B5	ISNSIN	Charge current sense input.
C1, C2, C3	LX	Switch node.
C4	AGND	Analog ground.
C5	SCL	Clock input for I ² C. Open-drain output, connect a 10kΩ pull-up resistor.
D1, D2, D3	PGND	Power ground for switching charger.
D4	BOOT	Bootstrap supply for high-side MOSFET. Connect a capacitor between BOOT and LX.
D5	SDA	Data input for I ² C. Open-drain output, connect a 10kΩ pull-up resistor.

Functional Block Diagram

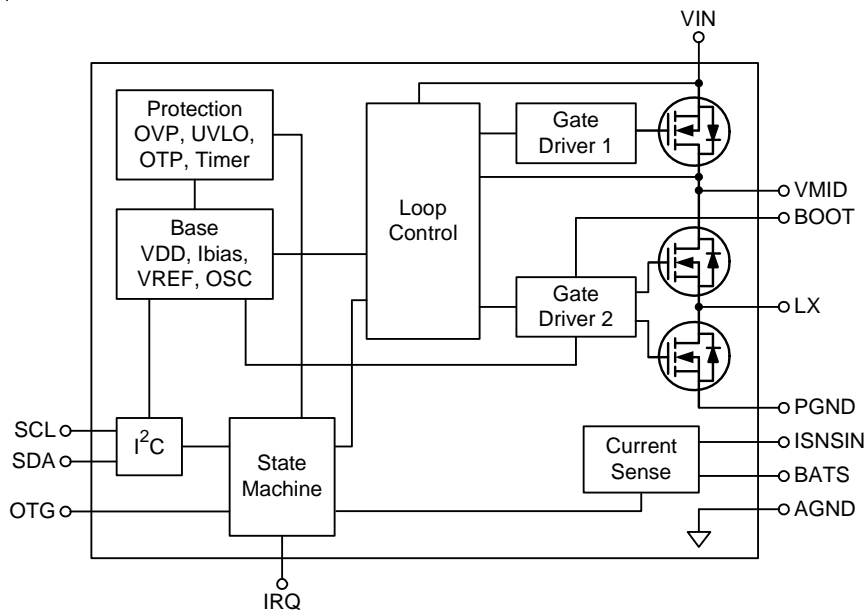

Operation

The RT9458 is a switch mode charger with USB-OTG support for single cell Li-Ion battery in portable applications.

Base Circuits

Base circuits provide the internal power, VDD and reference voltage and bias current.

Current Sense

Current sense circuit regulates the output current up to 1.5A to battery

Protection Circuits

The protection block includes the OVP, UVLO, OTP, Timer and other circuits. It turns off the charging when the charger IC or input power is in abnormal level.

Loop Controller and PWM and Driver

The multi-loop controller controls the PWM signal during the charging process. The PWM circuit controls the power stage through the driver. It makes sure that the battery is well-charged with suitable current, voltage and die-temperature.

I²C Interface

The I²C interface is used to program the charging parameters, ex : output current and output voltage.

State Machine

The State Machine controls the operation of the switching charger and outputs the interrupt via the IRQ pin if there is any fault be triggered.

Flow Charts

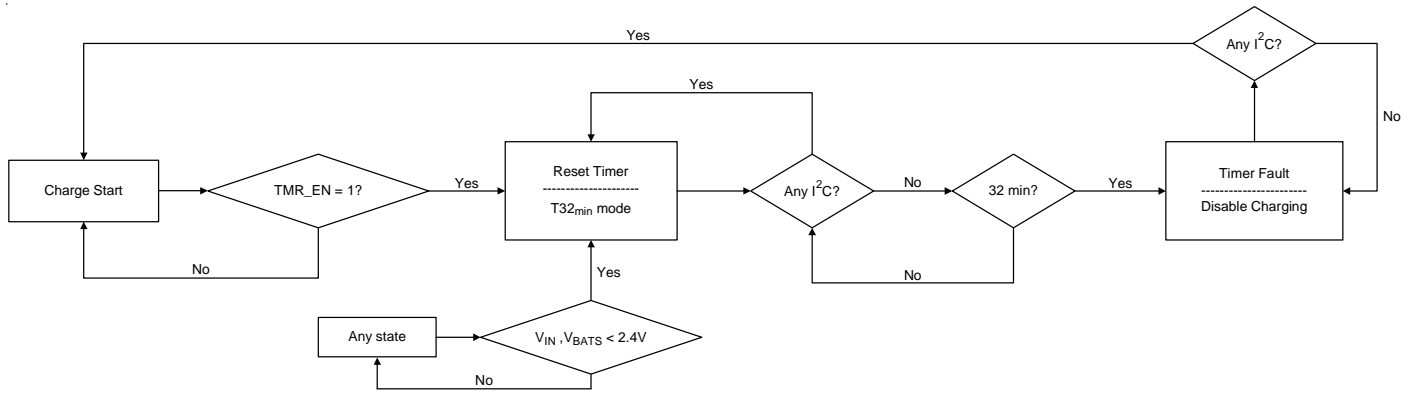

POR Reset

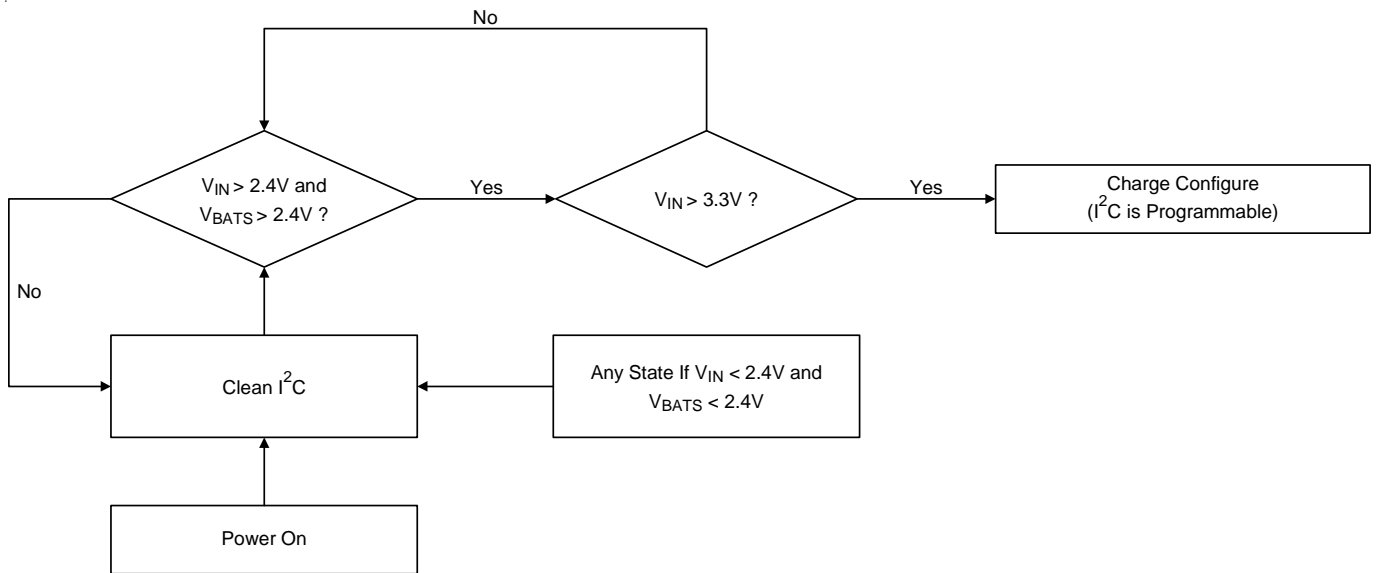

Charger Flow

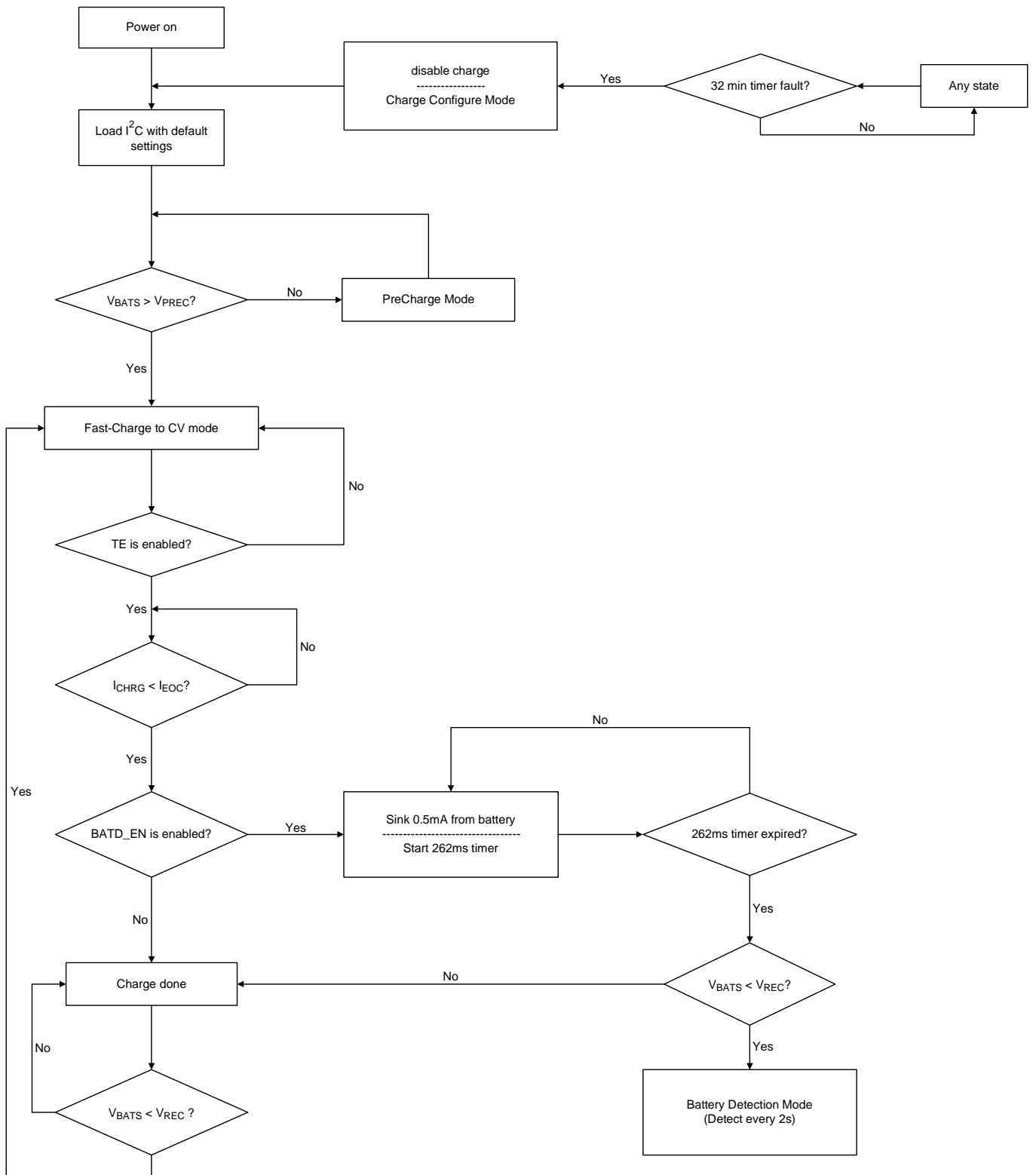

OTG Flow

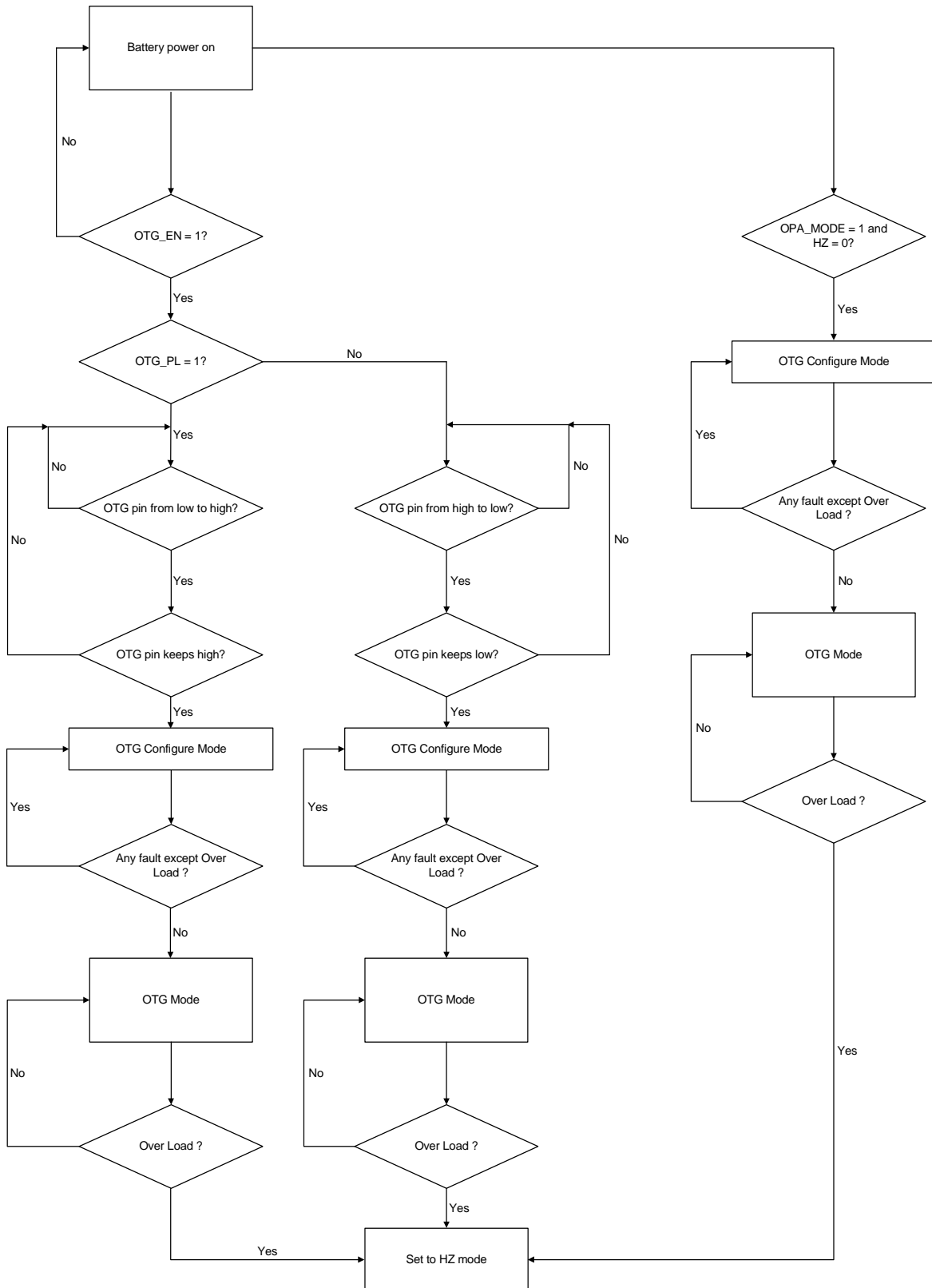

Absolute Maximum Ratings (Note 1)

- Supply Input Voltage, V_{IN} ----- -0.3V to 20V
- VMID, BOOT ----- -0.3V to 20V
- LX ----- -0.3V to 10V
- MID – VIN, BOOT – LX ----- -0.3V to 6V
- Other Pins ----- -0.3V to 6V
- Power Dissipation, P_D @ $T_A = 25^\circ\text{C}$
 WL-CSP-20B 2.1x1.87 (BSC) ----- 2.45W
- Package Thermal Resistance (Note 2)
 WL-CSP-20B 2.1x1.87 (BSC), θ_{JA} ----- 40.8°C/W
- Lead Temperature (Soldering, 10 sec.) ----- 260°C
- Junction Temperature ----- 150°C
- Storage Temperature Range ----- -65°C to 150°C
- ESD Susceptibility (Note 3)
 HBM (Human Body Model) ----- 2kV

Recommended Operating Conditions (Note 4)

- Supply Input Voltage, V_{IN} ----- 4.3V to 6V
- Junction Temperature Range ----- -40°C to 125°C
- Ambient Temperature Range ----- -40°C to 85°C

Electrical Characteristics

($V_{IN} = 5V$, $V_{BAT} = 4.2V$, $L = 1\mu\text{H}$, $C_{IN} = 0.47\mu\text{F}$, $C_{BATS} = 10\mu\text{F}$, $T_A = 25^\circ\text{C}$, unless otherwise specified)

Parameter	Symbol	Test Conditions	Min	Typ	Max	Unit
Protection						
V_{IN} OVP Threshold Voltage	V_{INOVP}	V_{IN} rising	6.4	6.7	7	V
V_{IN} OVP Hysteresis	V_{INOVP_Hys}		--	150	--	mV
Battery OVP	V_{BATOVP}	(Battery OVP – V_{OREG}) / V_{OREG}	110	117	124	%
Battery OVP Hysteresis	V_{BATOVP_Hys}		--	10	--	%
Over-Temperature Protection	OTP		--	165	--	°C
OTP Hysteresis	T_{OTP_Hys}		--	10	--	°C
Thermal Regulation Threshold		Charge current begins to reduce	--	120	--	°C
Sleep Mode Comparator						
Sleep-Mode Entry Threshold $V_{IN} - V_{BATS}$	V_{SLP}	$2.5V < V_{BATS} < V_{OREG}$, V_{IN} falling	0	0.04	0.1	V
Sleep-Mode Exit Hysteresis $V_{IN} - V_{BATS}$	$V_{SLPEXIT}$	$2.5V < V_{BATS} < V_{OREG}$, V_{IN} rising	40	100	200	mV
Sleep-Mode Deglitch Time	t_{SLP}	V_{IN} rising above $V_{SLP} + V_{SLPEXIT}$	--	128	--	ms
Under-Voltage Lockout Threshold						
IC Active Threshold Voltage	V_{UVLO}	V_{IN} rising	3.05	3.3	3.55	V
IC Active Hysteresis	ΔV_{UVLO}	V_{IN} falling from UVLO	--	150	--	mV

Parameter	Symbol	Test Conditions	Min	Typ	Max	Unit
Input Currents						
VIN Supply Current	I _Q	PWM switching, I _{CHRG} = I _{BAT} = 0mA	--	10	--	mA
		PWM is not switching. I _{CHRG} = I _{BAT} = 0mA	--	--	5	mA
		High impedance mode	--	--	150	μA
Leakage Current from Battery	I _{BAT}	V _{BATS} = 4.2V, V _{IN} = 0V, charger off	--	--	15	μA
Leakage from Battery to V _{BUS}	I _{BAT_LEK}	HZ mode = 1, V _{BAT} = 4.2V	--	0.2	5	μA
Input Power Regulation						
Minimum Input Voltage Regulation	V _{MIVR}	I ² C programmable per 0.1V	4.1	--	4.7	V
V _{MIVR} Accuracy	V _{MIVR_ACC}		-3	--	3	%
Average Input Current Regulation Accuracy	I _{AICR}	USB charge mode, I _{AICR} = 100mA	80	90	100	mA
		USB charge mode, I _{AICR} = 500mA	440	470	500	
Battery Voltage Regulation						
Battery Voltage Regulation	V _{OREG}	I ² C programmable per 20mV	3.5	--	4.44	V
V _{OREG} Accuracy	V _{OREG_ACC}	0 to 85°C	-1	--	1	%
Initial CV Voltage when V _{BUS} Plug in Before t _{ON_SET}	V _{CV_INI}	V _{IN} = 5V, without connect battery	--	4.35	--	V
Deglintch Time when CV is Determined by I ² C Setting After V _{BUS} Plug in	t _{ON_SET}	V _{IN} = 5V, without connect battery	--	1	--	s
Re-Charge Threshold	V _{REC}	V _{BATS} falling, below V _{OREG}	80	150	200	mV
Re-Charge Deglintch	t _{REC}		--	128	--	ms
Charging Current Regulation						
Output Charging Current	I _{CHRG}	I ² C programmable per 0.15A	0.5	--	1.55	A
I _{CHRG} Accuracy	I _{CHRG_ACC1}	500mA to 800Ma, no AICR limit	-7	--	7	%
	I _{CHRG_ACC2}	800mA to 1.55A, no AICR limit	-5	--	5	
Pre-Charge Threshold	V _{PREC}	I ² C programmable per 0.2V	2	--	3	V
V _{PREC} Accuracy	V _{PREC_ACC}		-5	--	5	%
Pre-Charge Current	I _{PREC}	I ² C programmable per 20mA	20	--	60	mA
I _{PREC} Accuracy	I _{PREC_ACC}		-50	--	50	%
Charge Termination Detection						
End of Charge Current	I _{EOC}	I ² C programmable per 50mA	50	--	400	mA
Deglintch Time for EOC	t _{EOC}	I _{CHRG} < I _{EOC} , V _{BATS} > V _{REC}	--	32	--	μs
End of Charge Current Accuracy	I _{EOC_ACC1}	I _{EOC} = 50mA to 100mA (R _{SENSE} = 56mΩ)	-15	--	15	%
	I _{EOC_ACC2}	I _{EOC} = 100mA to 250mA (R _{SENSE} = 56mΩ)	-10	--	10	
	I _{EOC_ACC3}	I _{EOC} = 250mA to 400mA (R _{SENSE} = 56mΩ)	-5.5	--	5.5	

Parameter	Symbol	Test Conditions	Min	Typ	Max	Unit
PWM						
Internal MOSFET On-Resistance	R _{DS}	From VIN to LX, as IAICR[1:0] = 11	--	185	240	mΩ
Internal MOSFET On-Resistance		From LX to PGND	--	90	120	mΩ
Charging Efficiency		V _{IN} = 5V, V _{BATS} = 4V, and I _{CHRG} = 1A	--	90	--	%
Oscillator Frequency	OSC		--	1.5	--	MHz
Frequency Accuracy			-10	--	10	%
Maximum Duty Cycle		At minimum voltage input	--	95	--	%
Minimum Duty Cycle			0	--	--	%
Peak OCP as Charger Mode	ICHARGOCP		2	2.9	3.8	A
Boost Mode Operation						
Output Voltage Level	VOTG	To VMID, I ² C programmable per 25mV	4.425	--	5.6	V
Output Voltage Accuracy	VOTG_ACC		-3	--	3	%
Efficiency		V _{IN} = 5V, V _{BATS} = 4V, and I _{IN} = 0.4A	--	92.5	--	%
MAX Output Current		V _{BATS} = 3.7V, V _{IN} = 5V	1	--	--	A
Peak Over Current Protection		V _{BATS} = 3.7V	2.75	4	5.25	A
V _{IN} OVP as OTG Boost			5.85	6.05	6.25	V
V _{IN} OVP Hysteresis			--	200	--	mV
Minimum Battery Voltage for Boost	V _{BATMIN}	As boost start-up	2.75	2.9	3.05	V
		During boost mode	2.35	2.5	2.65	
I²C Characteristics						
Output Low Voltage	V _{OL}	I _{DS} = 10mA	--	--	0.4	V
SCL, SDA Input Threshold Voltage	V _{IH}	Logic high threshold	1.3	--	--	V
	V _{IL}	Logic low threshold	--	--	0.4	
SCL Clock			--	--	400	kHz
Load Capacitance	C _{LOAD}	V _{PULL_UP} = 1.8V	--	--	1	pF

Note 1. Stresses beyond those listed “Absolute Maximum Ratings” may cause permanent damage to the device. These are stress ratings only, and functional operation of the device at these or any other conditions beyond those indicated in the operational sections of the specifications is not implied. Exposure to absolute maximum rating conditions may affect device reliability.

Note 2. θ_{JA} is measured under natural convection (still air) at T_A = 25°C with the component mounted on a high effective-thermal-conductivity four-layer test board on a JEDEC 51-7 thermal measurement standard.

Note 3. Devices are ESD sensitive. Handling precaution is recommended.

Note 4. The device is not guaranteed to function outside its operating conditions.

Typical Application Circuit

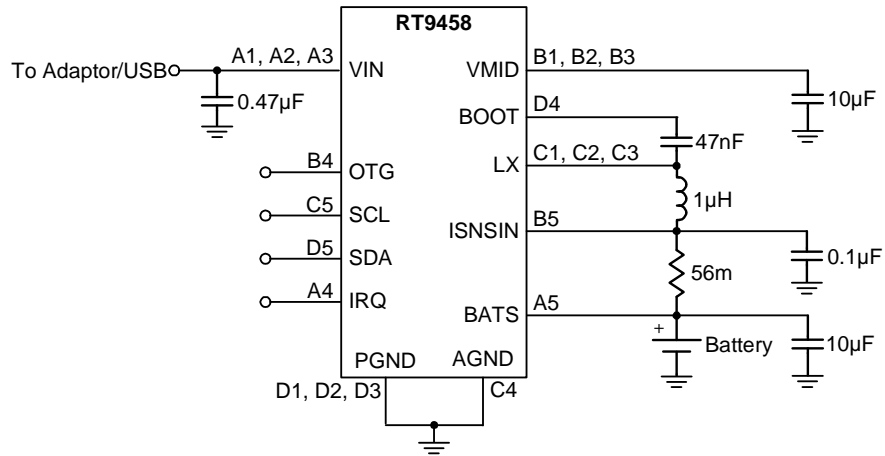

Below are recommended capacitor and inductor information

Pin	Description	Part Number	Package	Manufacture
VIN	0.47µF/25V/X5R	GRM155R61E474K01	0402	muRata
VMID	10µF/16V/X5R	GRM188R61C106KAAL	0603	muRata
BOOT	0.047µF/50V/X7R	GCM155R71H473KE01	0402	muRata
ISNSIN	0.1µF/10V/X5R	GRM155R61A104KA01	0402	muRata
BATS	10µF/6.3V/X5R	GRM185R60J106ME15	0603	muRata
ISNSIN	56mΩ/1%	RL10FTNR056	0805	TA-I
LX	1µH/20%	DFE252012-H-1R0M	252012	TOKO

Applications Information

The RT9458 is an integrated solution of single-cell Li-ion and Li-polymer battery charger for portable applications. The part integrates a synchronous PWM controller with power MOSFETs to provide input voltage MIVR (Minimum Input Voltage Regulation), input current sensing, high accuracy current and voltage regulation, and charge termination in a small package for space limited devices. The part also features USB OTG (On-The-Go).

The RT9458 has three operation modes : charge mode, boost mode (USB OTG), and high impedance mode. In charge mode, the RT9458 supports a precision charging system for single cell. In boost mode, the RT9458 works as the Boost converter and boosts the voltage from battery to VIN pin for sourcing the OTG devices. In high impedance mode, the RT9458 stops charging or boosting and operates in a mode with low current from VIN or battery to reduce the power consumption when the portable device is in standby mode.

Notice that the RT9458 does not integrate input power source (AC adapter or USB input) detection. Thus, the RT9458 does not set the charge current automatically. The charge current needs to be set via I²C interface by the host. The RT9458 application mechanism and I²C compatible interface are introduced in later sections. The slave address for this device is "1101010".

I²C Interface Timing Diagram

The RT9458 acts as an I²C -bus slave. The I²C -bus master configures the settings for charge mode and boost mode by sending command bytes to the RT9458 via the 2-wire I²C -bus. After the START condition, the I²C master sends a chip address. This address is seven bits long followed by an eighth bit which is a data direction bit (R/W). The second byte selects the register to which the data will be written. The third byte contains data to the selected register.

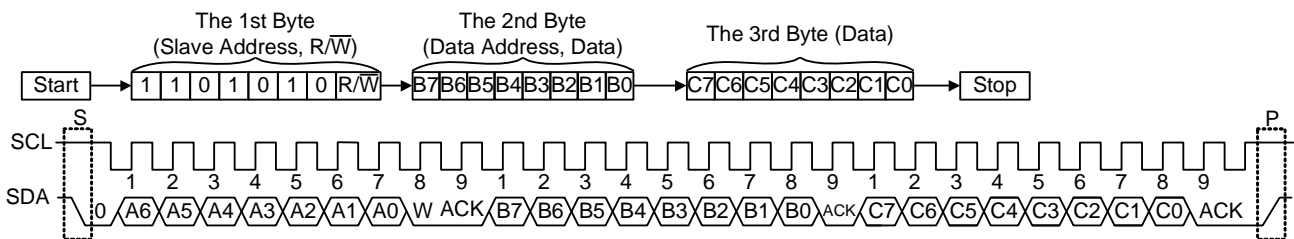

S = Start Condition
 W = Write (SDA = "0")
 R = Read (SDA = "1")

ACK = Acknowledge
 P = Stop Condition

Charge Mode Operation

Support Quick Start Feature of Charger

When the battery voltage is lower than 2.4V by over-discharge condition, the RT9458 charges the battery with 60mA to wake up the battery. Once the voltage level is higher than 2.4V, the RT9458 charges the battery to higher level with large current and makes sure that the system could work normally in short period with OTG pin pulled low.

Minimum Input Voltage Regulation (MIVR)

The RT9458 features input voltage MIVR function to prevent input voltage drop due to insufficient current provided by the adaptor or USB input. If MIVR function is enabled, the input voltage decreases when the over current of the input power source occurs and is regulated at a predetermined voltage level which can be set as 4.1V to 4.7V per 0.1V step by I²C interface to MIVR[2:0] in the register of address 0x11 the MIVR bit is set to high. At this time, the current drawn by the RT9458 equals to the maximum current value that the input power can provide at the predetermined voltage level, instead of the set value.

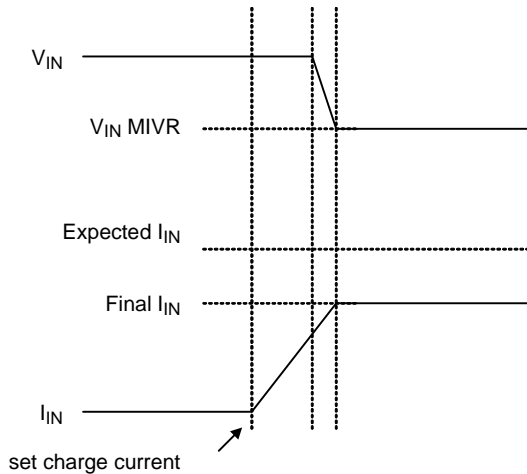

Figure 1. Minimum Input Voltage Regulation (MIVR)

Charge Profile

The RT9458 provides a precision Li-ion or Li-polymer charging solution for single-cell applications. Input current limit, charge current, termination current, charge voltage and input voltage MIVR are all programmable via the I²C interface. In charge mode, the RT9458 has five control loops to regulate input current, charge current, charge voltage, input voltage MIVR and device junction temperature. During the charging process, all five loops (if MIVR is enabled) are enabled and the dominant one will take over the control.

For normal charging process, the Li-ion or Li-polymer battery is charged in three charging modes depending on the battery voltage. At the beginning of the charging process, the RT9458 is in pre-charge mode. When the battery voltage rises above pre-charge threshold voltage (V_{PREC}), the RT9458 enters fast-charge mode. Once the battery voltage is close to the regulation voltage (V_{OREG}), the RT9458 enters constant voltage mode.

Pre-Charge Mode

For life-cycle consideration, the battery can not be charged with large current under low battery condition. When the BATS pin voltage is below pre-charge threshold voltage (V_{PREC}), the charger is in pre-charge mode with a weak charge current which equals to the pre-charge current (I_{PREC}). In pre-charge mode, the charger basically works as an LDO. The pre-charge current also acts as the current limit when the BATS pin is shorted.

Fast-Charge Mode and Settings

As the BATS pin rises above V_{PREC}, the charger enters fast-charge mode and starts switching. Notice that the RT9458 does not integrate input power source (AC adapter or USB input) detection. Thus, the RT9458 does not set the charge current automatically. Unlike the linear charger (LDO), the switching charger (Buck converter) is a current amplifier. The current drawn by the RT9458 is different from the current into the battery. The user can set the Average Input Current Regulation (AICR) and output charge current (I_{CHRG}) respectively.

Cycle-by-Cycle Current Limit

The charger of the RT9458 has an embedded cycle-by-cycle current limit for inductor. Once the inductor current touches the threshold (2.75A typ.), the charger stops charging immediately to prevent over current from damaging the device. Notice that, the mechanism can not be disabled by any way.

Average Input Current Regulation (AICR)

The AICR setting is controlled by the AICR section (bit 7 and 6) in the register of address 0x01. The written value of “00” is for USB100 mode with the maximum current limit of 100mA, “01” is for USB 500 mode with the maximum current limit of 500mA and “10” is for the maximum current limit of 1000mA. If the application does not need input current limit, write “11” into the IINLIMIT section.

Charge Current (I_{CHRG})

The charge current into the battery is determined by the sense resistor (R_{SENSE}) and I_{CHRG} section (bit4, bit5, and bit6) in the register of address 0x06. The voltage between the ISNSIN and BATS pins is regulated to the voltage control by I_{CHRG} section. The charge current equals to the voltage between the ISNSIN and BATS pins (V_{ICHRG}) divided by R_{SENSE} :

$$I_{CHRG} = \frac{V_{ICHRG}}{R_{SENSE}}$$

For example, for a 56mΩ sense resistor, the charge current can be set from 500mA (I_{CHRG} [2:0] = 000) to 1550mA (I_{CHRG} [2:0] = 111).

When input current limit and charge current are both set, the charge current in fast charge phase is calculated as below :

$$I_{CHRG} = \text{MIN} \left[\frac{V_{ICHRG}}{R_{SENSE}}, \left(\frac{I_{IN_LIMIT}}{D} \times \eta \right) \right]$$

where D is the duty cycle and η is the efficiency.

Constant Voltage Mode and Settings

The RT9458 enters constant voltage mode when the BATS voltage is close to the output-charge voltage (V_{OREG}). Once in this mode, the charge current begins to decrease. For default settings (charge current termination is disabled), the RT9458 does not turn off and always regulates the battery voltage at V_{OREG} . However, once the charge current termination is enabled, the charger terminates if the charge current is below termination current (I_{EOC}) in constant voltage mode. The charge current termination function is controlled by the I²C interface in the "TE" bit via the register of address 0x01.

After termination, a new charge cycle restarts when one of the following conditions is detected :

- ▶ The BATS pin voltage falls below the $V_{OREG} - V_{RECH}$ threshold.
- ▶ VIN Power On Reset (POR).
- ▶ CHG_EN bit toggle or RST bit is set (via I²C interface).

Output Charge Voltage (V_{OREG})

The output-charge voltage is set by the I²C interface in the CV section (Bit2 to Bit7 bits) via the register of address 0x02. Its range is from 3.5V to 4.45V. The default is 4.2V (100011).

Termination Current (I_{EOC})

If the end of charge detection and shutdown control for EOC are both enable (TE bit = "1", TE_SHDN_EN bit = "1"), the end-of-charge current is determined by both the charge current (I_{CHRG}) and I_{EOC} percentage. I_{EOC} percentage is set by the I²C interface in the I_{EOC} section via the register of address 0x05. Its range is from 50mA to 400mA with an step of 50mA.

Safety Timer in Charge Mode and in OTG Mode

To implement safety mechanism, the RT9458 has two timer modes : T32min mode with a 32-minute timer for charger mode and T32sec mode with a 32-second timer for OTG mode.

In the charger mode, at the beginning of a charging operation, the RT9458 enters T32min mode and starts a 32-minute timer that can be reset by any read or write action performed by the host through the I²C interface. If the 32-minute timer expires, the charging operation is terminated and shows the fault bit CH32MI.

In the OTG mode, at the beginning of a OTG operation, the RT9458 enters T32sec mode and starts a 32-second timer that can be reset by any read or write action performed by the host through the I²C interface. If the 32-second timer expires, the OTG operation will keep going but shows the fault bit BST32SI.

Input Voltage Protection in Charge Mode

During charge mode, there are two protection mechanisms against poor input power source.

Sleep Mode ($V_{IN} - V_{BATS} < V_{SLP}$)

The RT9458 enters sleep mode if the voltage drop between the VIN and BATS pins falls below V_{SLP} . In sleep mode, the reverse blocking switch and PWM are all turned off. This function prevents battery drain during poor or no input power source.

Input Over-Voltage Protection

When VIN voltage rises above the input over-voltage threshold (V_{INOVVP}), the RT9458 stops charging and then sets fault status bits. The condition is released when VIN falls below $V_{INOVVP} - V_{INOVVP_Hys}$. The RT9458 then resumes charging operation.

Boost Mode Operation (OTG)

Trigger and Operation

The RT9458 features USB OTG. When OTG function is enabled, the synchronous boost control loop takes over the power MOSFETs and reverses the power flow from the battery to the VIN pin. In normal boost mode, the VMID pin is regulated to 5V (typ.) and provides up to 1A current to support other USB OTG devices connected to the USB connector.

Output Over-Voltage Protection

In boost mode, the output over-voltage protection is triggered when the VIN voltage is above the output OVP threshold (6V typ.). When OVP occurs and the boost mode is triggered by the OTG pin, the RT9458 goes back to Boost Configure state. When VIN returns to normal operating range, the condition is released and the boost resumes switching. However, if the boost mode is triggered by OPA bit, the RT9458 resets the OPA bit and goes back to Charge Configure state with default charge parameters.

Output Overload Protection

The RT9458 provides an overload protection to prevent the device and battery from damage when VIN is overload. Once overload condition is detected, the reverse blocking switch operates in linear region to limit the output current while the VMID voltage remains in voltage regulation. If the overload condition lasts for more than 32ms, the RT9458 will recognise the overload fault condition and resets registers to the default settings.

Control Bits

CHG_EN Bit (Charge Mode)

The CHG_EN bit in control register of address 0x07 is used to disable or enable the charge process. A value of "0" disable the charge, while a value of "1" enable the charge.

RST Bit

The RST bit in control register of address 0x04 is used to reset the RT9458 back to its default value at power-up, regardless of its charging or boosting process.

HZ (High Impedance Mode) Bit

When the HZ bit is set to "1" and the OTG pin is not in active status, the RT9458 operates in high impedance mode. The condition is released by POR or setting the HZ bit to "0".

OPA Bit

The OPA bit is the operation mode control bit, which is dependent on the status of HZ.

OPA bit	HZ bit	Operation
0	0	Charge mode (no fault) Charge configure (fault, $V_{IN} > V_{UVLO}$) High impedance mode ($V_{IN} < V_{UVLO}$)
1	0	Boost mode (no fault) Go to charge configure when any fault
X	1	High impedance mode

Battery Protection

Battery Over-Voltage Protection in Charge Mode

The RT9458 monitors the BATS voltage for output over-voltage protection. In charge mode, if the BATS voltage rises above $V_{BATOVP} \times V_{OREG}$, such as when the battery is suddenly removed, the RT9458 stops charging and then sets fault status bits. The condition is released when the BATS voltage falls below $(V_{BATOVP} - V_{BATOVP_Hys}) \times V_{OREG}$. The RT9458 then resumes charging process with default settings and the fault is cleared.

Battery Detection During Normal Charging

The RT9458 provides a battery absent detection scheme to detect insertion or removal of the battery pack. The battery detection scheme is valid only when the charge current termination is enabled (TE bit = "1").

During normal charging process, once the charge done condition is satisfied ($V_{BATS} > V_{OREG} - V_{RECH}$ and termination current is detected), the RT9458 turns off the PWM converter and initiates a discharge current (detection current) for a detection time period. After that, the RT9458 checks the BATS voltage. If it is still above the recharge threshold, the battery is present and charge done is detected. If the BATS voltage is below the recharge threshold, the battery is absent. Thus, the RT9458 stops charging and the charge parameters are reset to the default values. The charge resumes after a period of t_{DET} (2sec. typ.).

Thermal Considerations

The junction temperature should never exceed the absolute maximum junction temperature $T_{J(MAX)}$, listed under Absolute Maximum Ratings, to avoid permanent damage to the device. The maximum allowable power dissipation depends on the thermal resistance of the IC package, the PCB layout, the rate of surrounding airflow, and the difference between the junction and ambient temperatures. The maximum power dissipation can be calculated using the following formula :

$$P_{D(MAX)} = (T_{J(MAX)} - T_A) / \theta_{JA}$$

where $T_{J(MAX)}$ is the maximum junction temperature, T_A is the ambient temperature, and θ_{JA} is the junction-to-ambient thermal resistance.

For continuous operation, the maximum operating junction temperature indicated under Recommended Operating Conditions is 125°C. The junction-to-ambient thermal resistance, θ_{JA} , is highly package dependent. For a WL-CSP-20B 2.1x1.87 (BSC) package, the thermal resistance, θ_{JA} , is 40.8°C/W on a standard JEDEC 51-7 high effective-thermal-conductivity four-layer test board. The maximum power dissipation at $T_A = 25^\circ\text{C}$ can be calculated as below :

$$P_{D(MAX)} = (125^\circ\text{C} - 25^\circ\text{C}) / (40.8^\circ\text{C/W}) = 2.45\text{W for a WL-CSP-20B 2.1x1.87 (BSC) package.}$$

The maximum power dissipation depends on the operating ambient temperature for the fixed $T_{J(MAX)}$ and the thermal resistance, θ_{JA} . The derating curves in Figure 2 allows the designer to see the effect of rising ambient temperature on the maximum power dissipation.

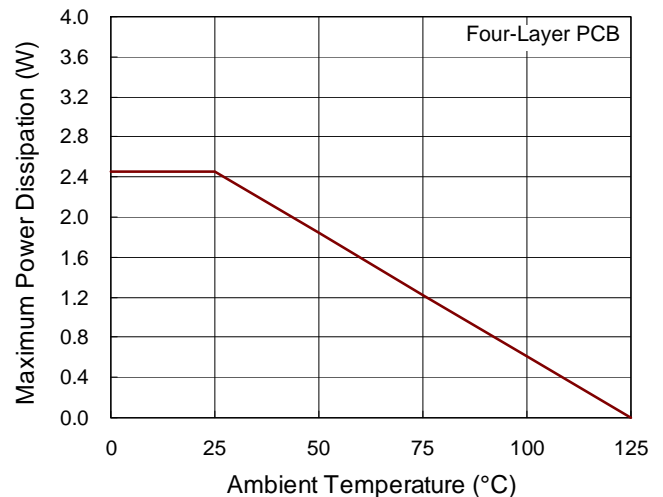

Figure 2. Derating Curve of Maximum Power Dissipation

Layout consideration

The RT9458 layout guideline is shown as follow. There are several suggestion are provided.

- ▶ The capacitor of VMID should be as close as possible to RT9458 for reduce EMI.
- ▶ The GND path of VMID and BATS capacitor need to connect directly at TOP layer.
- ▶ The traces of Rsense need to follow differential rule to avoid the common mode noise.
- ▶ The other layers are ground plane for improve thermal performance.

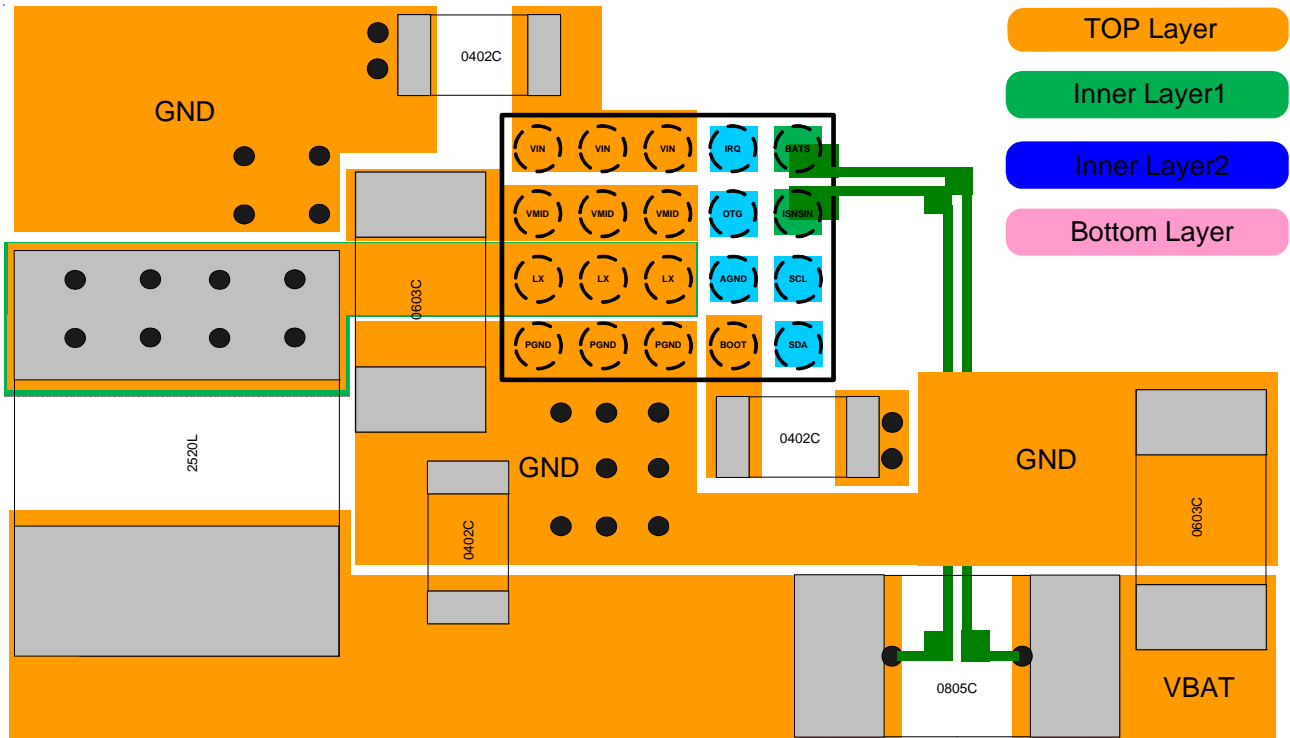
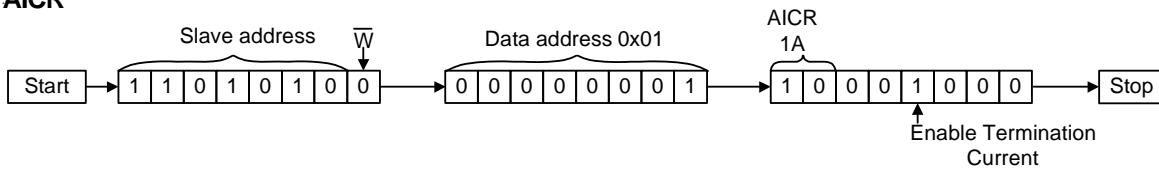
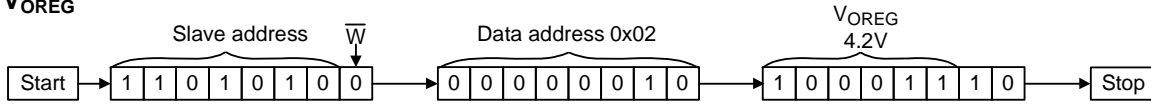

Figure 3. PCB Layout Guide

AICR



VOREG



I_{CHRG}, I_{EOC}

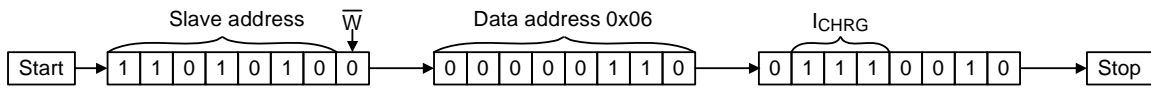
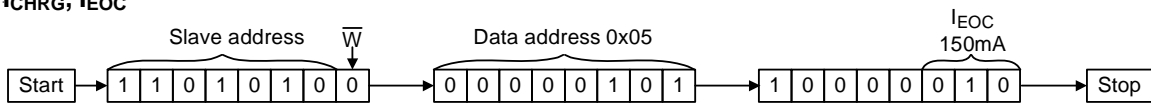

High Impedance Mode

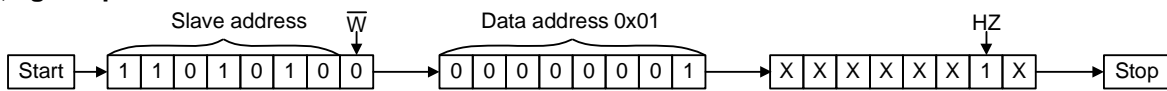

Boost Mode

There are two methods to trigger boost mode.

I²C - Triggered Boost Mode

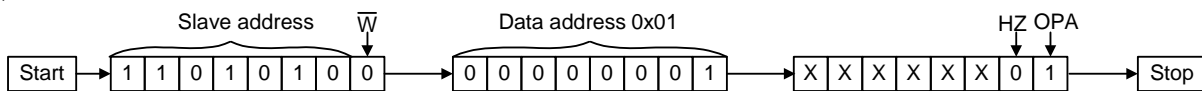

OTG Pin - Triggered Boost Mode (Pull High or Pull Low)

Pull High

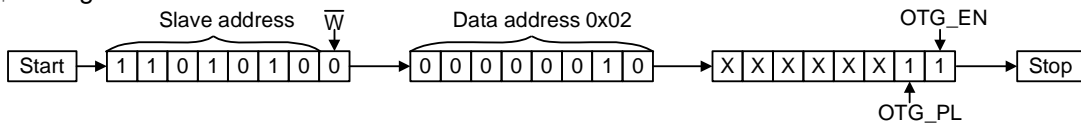

Pull Low

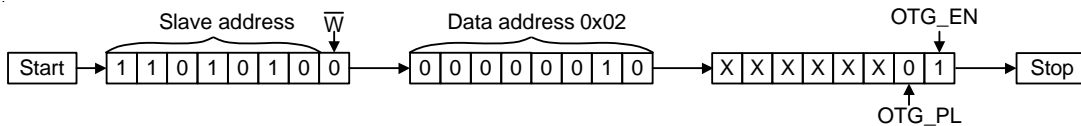

Keep Monitoring RT9458

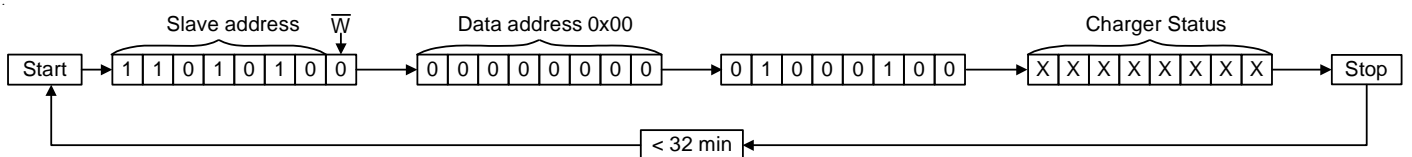

Device Address : 1101010

Address	Name	Bit7	Bit6	Bit5	Bit4	Bit3	Bit2	Bit1	Bit0
0x03	Device ID	VENDOR_ID				CHIP_REV			
	Reset Value	0	0	0	0	0	0	0	1
	Read/Write	R	R	R	R	R	R	R	R
0x00	Control1	Reserved	Reserved	STAT		BOOST	PWR_Rdy	OTG_PinP	Reserved
	Reset Value	0	1	0	0	0	0	0	0
	Read/Write	R/W	R/W	R	R	R	R	R	R
0x01	Control2	IAICR[1:0]		TE_SHDN_EN	Higher_OCP	TE	IAICR_INT	HZ	OPA_MODE
	Reset Value	0	0	0	0	0	0	0	0
	Read/Write	R/W	R/W	R/W	R/W	R/W	R/W	R/W	R/W
0x02	Control3	VOREG[5:0]						OTG_PL	OTG_EN
	Reset Value	1	0	0	0	1	1	1	0
	Read/Write	R/W	R/W	R/W	R/W	R/W	R/W	R/W	R/W
0x04	Control4	RST	Reserved	Reserved	Reserved	Reserved	Reserved	Reserved	Reserved
	Reset Value	0	0	0	0	0	0	0	0
	Read/Write	R/W	R/W	R/W	R/W	R/W	R/W	R/W	R/W
0x05	Control5	TMR_EN	Reserved	Reserved	Reserved	Reserved	IEOC[2:0]		
	Reset Value	1	0	0	0	0	0	1	0
	Read/Write	R/W	R/W	R/W	R/W	R/W	R/W	R/W	R/W
0x06	Control6	IAICR_SEL	ICHRG[2:0]			FixFreq	VPREC[2:0]		
	Reset Value	0	0	0	0	0	0	1	0
	Read/Write	R/W	R/W	R/W	R/W	R/W	R/W	R/W	R/W
0x07	Control7	Reserved	BATD_EN	Reserved	CHG_EN	VMREG[3:0]			
	Reset Value	0	0	0	1	0	0	0	0
	Read/Write	R/W	R/W	R/W	R/W	R/W	R/W	R/W	R/W
0x08	IRQ1	TSDI	VINOVPI	Reserved	Reserved	Reserved	Reserved	Reserved	BATAB
	Reset Value	0	0	0	0	0	0	0	0
	Read/Write	R	R	R	R	R	R	R	R

Address	Name	Bit7	Bit6	Bit5	Bit4	Bit3	Bit2	Bit1	Bit0
0x09	IRQ2	CHRVPI	Reserved	CHBATOVI	CHTERMI	CHRCHGI	CH32MI	CHTREGI	CHMIVRI
	Reset Value	0	0	0	0	0	0	0	0
	Read/Write	R	R	R	R	R	R	R	R
0x0A	IRQ3	BSTVINOVI	BSTOLI	BSTLOWVI	Reserved	BST32SI	Reserved	Reserved	Reserved
	Reset Value	0	0	0	0	0	0	0	0
	Read/Write	R	R	R	R	R	R	R	R
0x0B	Mask 1	TSDM	VINOVPIM	Reserved	Reserved	Reserved	Reserved	Reserved	BATABM
	Reset Value	0	0	0	0	0	0	0	0
	Read/Write	R/W	R/W	R/W	R/W	R/W	R/W	R/W	R/W
0x0C	Mask 2	CHRVPI M	Reserved	CHBATOVI M	CHTERMI M	CHRCHGI M	CH32MIM	CHTREGI M	CHMIVRI M
	Reset Value	0	0	0	0	0	0	0	0
	Read/Write	R/W	R/W	R/W	R/W	R/W	R/W	R/W	R/W
0x0D	Mask 3	BSTVINOVI M	BSTOLIM	BSTLOWVI M	Reserved	BST32SI M	Reserved	Reserved	Reserved
	Reset Value	0	0	0	0	0	0	0	0
	Read/Write	R/W	R/W	R/W	R/W	R/W	R/W	R/W	R/W
0x11	Control8	Reserved	MIVR[2:0]			Reserved	Reserved	IPREC[1:0]	
	Reset Value	0	1	0	0	0	0	1	0
	Read/Write	R/W	R/W	R/W	R/W	R/W	R/W	R/W	R/W
0x15	IRQ Status	Reserved	Reserved	Reserved	Reserved	Reserved	VINOVP	THEMREG	MIVR
	Reset Value	0	1	0	0	0	0	1	0
	Read/Write	R/W	R/W	R/W	R/W	R/W	R/W	R/W	R/W

Detail Table Descriptions

Address	Name	Bit7	Bit6	Bit5	Bit4	Bit3	Bit2	Bit1	Bit0
0x03	Device ID	VENDOR_ID				CHIP_REV			
	Reset Value	0	0	0	0	0	0	0	1
	Read/Write	R	R	R	R	R	R	R	R
VENDOR_ID		Vendor Identification							
CHIP_REV		Chip Revision							

Address	Name	Bit7	Bit6	Bit5	Bit4	Bit3	Bit2	Bit1	Bit0
0x00	Control1	Reserved	Reserved	STAT		BOOST	PWR_Rdy	OTG_PinP	Reserved
	Reset Value	0	1	0	0	0	0	0	0
	Read/Write	R/W	R/W	R	R	R	R	R	R
STAT		Charger status bit 00 : Ready 01 : Charge in progress 10 : Charge done 11 : Fault							
BOOST		1 : Boost mode, 0 : Not in Boost mode							
PWR_Rdy		Power status bit 0 : VIN > VOVP or VIN < UVLO or VIN < BATS + VSLP (Power Fault) 1 : UVLO < VIN < VOVP & VIN > BATS + VSLP (Power Ready)							
OTG_PinP		OTG pin polarity 0 : OTG input pin is low 1 : OTG input pin is high							

Address	Name	Bit7	Bit6	Bit5	Bit4	Bit3	Bit2	Bit1	Bit0
0x01	Control2	IAICR[1:0]		TE_SHDN_EN	Reserved	TE	IAICR_INT	HZ	OPA_MODE
	Reset Value	0	1	0	0	0	0	0	0
	Read/Write	R/W	R/W	R/W	R/W	R/W	R/W	R/W	R/W
IAICR[1:0]		When IAICR_SEL = 0 00 : VIN 100mA current limit, 01 : VIN 500mA current limit, 10 : VIN 1A current limit, 11 : no input current limit (default 01) When IAICR_SEL = 1 00 : VIN 100mA current limit, 01 : VIN 700mA current limit, 10 : VIN 700mA current limit, 11 : no input current limit (default 01)							
TE_SHDN_EN		0 : When EOC is triggered, charge is not shutdown 1 : When EOC is triggered, charge is shutdown							
TE		1 : Enable end of charge detection, 0 : Disable end of charge detection (default 0)							
IAICR_INT		IAICR setting bit 0 : decided by external OTG pin, 500mA current limit when OTG pin is low and 100mA current limit when OTG pin is high 1 : decided by internal I ² C IAICR[1:0] code							
HZ		1 : High impedance mode, 0 : Not high impedance mode (default 0)							
OPA_MODE		1 : Boost mode, 0 : Charger mode (default 0)							

Address	Name	Bit7	Bit6	Bit5	Bit4	Bit3	Bit2	Bit1	Bit0
0x02	Control3	VOREG[5:0]						OTG_PL	OTG_EN
	Reset Value	1	0	0	0	1	1	1	0
	Read/Write	R/W	R/W	R/W	R/W	R/W	R/W	R/W	R/W
	VOREG[5:0]	Battery regulation voltage / Boost output voltage. The delta-V of the Battery regulation voltage is 20mV. The delta-V of the Boost output voltage is 25mV. Only from 101000 to 101001, the delta-V is 30mV for battery regulation voltage. 00 0000 : 3.5V / 4.425V 00 0001 : 3.52V / 4.45V 00 0010 : 3.54V / 4.475V ... 01 1000 : 3.98V / 5.025V 01 1001 : 4V / 5.05V 01 1010 : 4.02V / 5.075V ... 100010 : 4.18V / 5.3V 100011 : 4.2V / 5.325V 100100 : 4.22V / 5.35V ... 10 1000 : 4.3V / 5.425V 10 1001 : 4.33V / 5.45V 10 1010 : 4.35V / 5.475V 10 1011 : 4.37V / 5.5V ... 10 1111 : 4.45V / 5.6V ... 11 1111 : 4.45V / 5.6V							
	OTG_PL	1 : Active at High level, 0 : Active at low level (default 1)							
	OTG_EN	1 : Enable OTG Pin, 0 : Disable OTG Pin (default 0)							

Address	Name	Bit7	Bit6	Bit5	Bit4	Bit3	Bit2	Bit1	Bit0
0x04	Control4	RST	Reserved	Reserved	Reserved	Reserved	Reserved	Reserved	Reserved
	Reset Value	0	0	0	0	0	0	0	0
	Read/Write	R/W	R/W	R/W	R/W	R/W	R/W	R/W	R/W
RST		Write 1 : Charger in reset mode, 0 : No effect, Read : always get "0"							

Address	Name	Bit7	Bit6	Bit5	Bit4	Bit3	Bit2	Bit1	Bit0
0x05	Control5	TMR_EN	Reserved	Reserved	Reserved	Reserved	IEOC[2:0]		
	Reset Value	1	0	0	0	0	0	1	0
	Read/Write	R/W	R/W	R/W	R/W	R/W	R/W	R/W	R/W
TMR_EN		0 : Disable internal timer function, 1 : Enable internal timer function (default 1)							
IEOC[2:0]		000 : 50mA 001 : 100mA 010 : 150mA (default) 011 : 200mA 100 : 250mA 101 : 300mA 110 : 350mA 111 : 400mA							

Address	Name	Bit7	Bit6	Bit5	Bit4	Bit3	Bit2	Bit1	Bit0
0x06	Control6	IAICR_SEL	ICHRG[2:0]			FixFreq	VPREC[2:0]		
	Reset Value	0	0	0	0	0	0	1	0
	Read/Write	R/W	R/W	R/W	R/W	R/W	R/W	R/W	R/W
IAICR_SEL		0 : AICR is defined by IAICR [1:0] 1 : AICR 500mA and 1A becomes 700mA							
ICHRG[2:0]		External Sensing R : Charge current sense voltage (current equivalent for 56mΩ sense resistor) 000 : 28mV (500mA) (default 000) 001 : 36.4mV (650mA) 010 : 44.8mV (800mA) --- 110 : 78.4mV (1400mA) 111 : 86.8mV (1550mA)							
VPREC[2:0]		000 : 2V 001 : 2.2V 010 : 2.4V (default 010) 011 : 2.6V 100 : 2.8V 101 : 3V ... 111 : 3V							
Fix Freq		0 : Auto frequency change 1 : Fix frequency							

Address	Name	Bit7	Bit6	Bit5	Bit4	Bit3	Bit2	Bit1	Bit0
0x07	Control 7	Reserved	BATD_EN	Reserved	CHG_EN	VMREG[3:0]			
	Reset Value	0	0	0	1	0	0	0	0
	Read/Write	R/W	R/W	R/W	R/W	R/W	R/W	R/W	R/W
BATD_EN		Battery detection when charge done 0 : disable battery detection, 1 : enable battery detection							
CHG_EN		Charger enable 0 : charger is disabled, 1 : charger is enabled							
VMREG[3:0]		Maximum battery regulation voltage/Maximum Boost output voltage. The delta-V of Maximum battery regulation voltage is 20mV. The delta-V of Maximum Boost output voltage is 25mV. 0000 : 4.2V / 5.3V (Default 0000) 0001 : 4.22V / 5.325V 0010 : 4.24V / 5.35V ... 1011 : 4.43V / 5.575V 1100 : 4.45V / 5.6V ... 1111 : 4.45V / 5.6V							

Address	Name	Bit7	Bit6	Bit5	Bit4	Bit3	Bit2	Bit1	Bit0
0x08	IRQ 1	TSDI	VINOVP	Reserved	Reserved	Reserved	Reserved	Reserved	BATAB
	Reset Value	0	0	0	0	0	0	0	0
	Read/Write	R	R	R	R	R	R	R	R
TSDI		Thermal shutdown fault. Set if the die temperature exceeds the thermal shutdown threshold. When TSDI occurs, REG0 x 01[7:6]-AICR is reset to 01.							
VINOVP		VIN over voltage protection. Set when VIN > VIN_OVP is detected							
BATAB		Battery absence							

Address	Name	Bit7	Bit6	Bit5	Bit4	Bit3	Bit2	Bit1	Bit0
0x09	IRQ 2	CHRVPI	Reserved	CHBATОВI	CHTERMI	CHRCHGI	CH32MI	CHTREGI	CHMIVRI
	Reset Value	0	0	0	0	0	0	0	0
	Read/Write	R	R	R	R	R	R	R	R
CHRVPI		Charger fault. Reverse protection (VIN < BATS + VSLP)							
CHBATОВI		Charger fault. Battery OVP							
CHTERMI		Charge terminated							
CHRCHGI		Recharge request (VBATS < VOREG – VRECH)							
CH32MI		Charger fault. 32m time-out (fault)							
CHTREGI		Charger warning. Thermal regulation loop active.							
CHMIVRI		Charger warning. Input voltage MIVR loop active.							

Address	Name	Bit7	Bit6	Bit5	Bit4	Bit3	Bit2	Bit1	Bit0
0x11	Control8	Reserved	MIVR[2:0]			Reserved	Reserved	IPREC[1:0]	
	Reset Value	0	1	0	0	0	0	1	0
	Read/Write	R/W	R/W	R/W	R/W	R/W	R/W	R/W	R/W
MIVR[2:0]		000 : 4.1V 001 : 4.2V 010 : 4.3V 011 : 4.4V 100 : 4.5V (default) 101 : 4.6V 110 : 4.7V 111 : disable							
IPREC[1:0]		00 : 20mA 01 : 40mA 10 : 60mA (default) 11 : 60mA							

Address	Name	Bit7	Bit6	Bit5	Bit4	Bit3	Bit2	Bit1	Bit0
0x0A	IRQ 3	BSTVINOVI	BSTOLI	BSTLOWVI	Reserved	BST32SI	Reserved	Reserved	Reserved
	Reset Value	0	0	0	0	0	0	0	0
	Read/Write	R	R	R	R	R	R	R	R
BSTBUSOVI		Boost fault. VIN OVP (VIN > VIN_BOVP)							
BSTOLI		Boost fault. Over load.							
BSTLOWVI		Boost fault. Battery voltage is too low.							
BST32SI		Boost fault. 32s time-out fault.							
Reserved		N/A							
Reserved		N/A							
Reserved		N/A							

Address	Name	Bit7	Bit6	Bit5	Bit4	Bit3	Bit2	Bit1	Bit0
0x0B	MASK1	TSDM	VINOVPIM	Reserved	Reserved	Reserved	Reserved	Reserved	BATABM
	Reset Value	0	0	0	0	0	0	0	0
	Read/Write	R/W	R/W	R	R	R	R	R/W	R/W
TSDM		TSDI fault interrupt mask 0 : interrupt is not masked, 1 : interrupt is masked							
VINOVPIM		VIN OVP fault interrupt mask 0 : interrupt is not masked, 1 : interrupt is masked							
BATABM		Battery absence fault interrupt mask 0 : interrupt is not masked, 1 : interrupt is masked							

Address	Name	Bit7	Bit6	Bit5	Bit4	Bit3	Bit2	Bit1	Bit0
0x0C	MASK2	CHRVPIIM	Reserved	CHBATO VIM	CHTERMIM	CHRCHGIM	CH32MIM	CHTREGIM	CHMIVRM
	Reset Value	0	0	0	0	0	0	0	0
	Read/Write	R/W	R/W	R/W	R/W	R/W	R/W	R/W	R/W
CHRVPIIM		Charger reverse protection interrupt mask 0 : interrupt is not masked, 1 : interrupt is masked							
CHBATO VIM		Charger battery over voltage interrupt mask 0 : interrupt is not masked, 1 : interrupt is masked							
CHTERMIM		Charge terminated interrupt mask 0 : interrupt is not masked, 1 : interrupt is masked							
CHRCHGIM		Charger recharge request interrupt mask 0 : interrupt is not masked, 1 : interrupt is masked							
CH32MIM		Charger 32m timeout interrupt mask 0 : interrupt is not masked, 1 : interrupt is masked							
CHTREGIM		Charger thermal regulation loop active interrupt mask 0 : interrupt is not masked, 1 : interrupt is masked							
CHMIVRM		Charger input current voltage MIVR active interrupt mask 0 : interrupt is not masked, 1 : interrupt is masked							

Address	Name	Bit7	Bit6	Bit5	Bit4	Bit3	Bit2	Bit1	Bit0
0x0D	MASK3	BSTVINO VIM	BSTOLIM	BSTLOW VIM	Reserved	BST32SIM	Reserved	Reserved	Reserved
	Reset Value	0	0	0	0	0	0	0	0
	Read/Write	R/W	R/W	R/W	R/W	R/W	R/W	R/W	R/W
BSTVINO VIM		Boost VIN over voltage interrupt mask 0 : interrupt is not masked, 1 : interrupt is masked							
BSTOLIM		Boost over load interrupt mask 0 : interrupt is not masked, 1 : interrupt is masked							
BSTLOW VIM		Boost low battery voltage interrupt mask 0 : interrupt is not masked, 1 : interrupt is masked							
BST32SIM		Boost 32s time out interrupt mask 0 : interrupt is not masked, 1 : interrupt is masked							

Outline Dimension

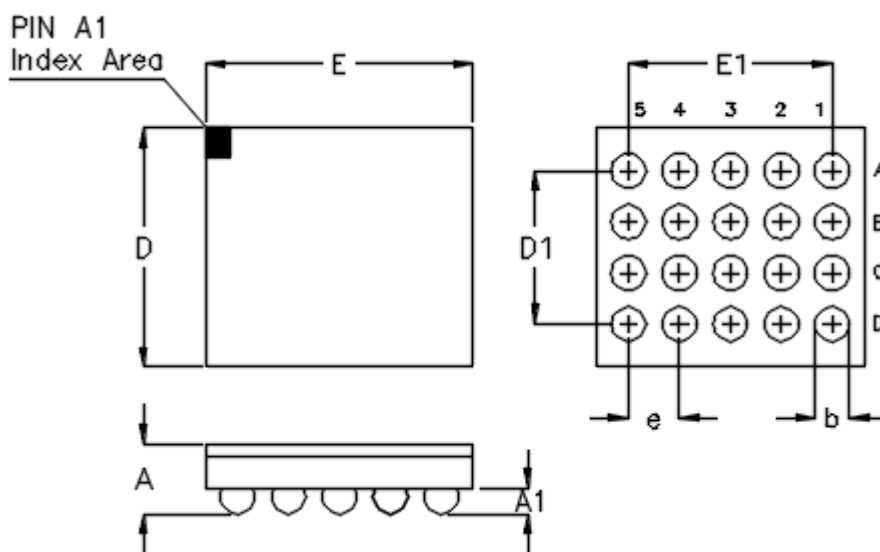

Symbol	Dimensions In Millimeters		Dimensions In Inches	
	Min	Max	Min	Max.
A	0.500	0.600	0.020	0.024
A1	0.170	0.230	0.007	0.009
b	0.240	0.300	0.009	0.012
D	1.820	1.920	0.072	0.076
D1	1.200		0.047	
E	2.050	2.150	0.081	0.085
E1	1.600		0.063	
e	0.400		0.016	

20B WL-CSP 2.1x1.87 Package (BSC)



Richtek Technology Corporation

14F, No. 8, Tai Yuen 1st Street, Chupei City
 Hsinchu, Taiwan, R.O.C.
 Tel: (8863)5526789

Richtek products are sold by description only. Richtek reserves the right to change the circuitry and/or specifications without notice at any time. Customers should obtain the latest relevant information and data sheets before placing orders and should verify that such information is current and complete. Richtek cannot assume responsibility for use of any circuitry other than circuitry entirely embodied in a Richtek product. Information furnished by Richtek is believed to be accurate and reliable. However, no responsibility is assumed by Richtek or its subsidiaries for its use; nor for any infringements of patents or other rights of third parties which may result from its use. No license is granted by implication or otherwise under any patent or patent rights of Richtek or its subsidiaries.

Looking for pricing, stock, or lifecycle information?

Click below to explore more details on WIN SOURCE:

-  [View RT9458WSC on WIN SOURCE](#)
-  [Richtek USA Inc. Information](#)

Optimize Your Supply Chain with WIN SOURCE Solutions

-  Global Sourcing Solution
-  Obsolete Management
-  Cost Control Management
-  Shortage Management
-  Alternative Solution
-  Excess Inventory Management