



**THE DATASHEET OF  
RP15-2405SFW**



# Features

- Wide 4:1 input voltage range
- 1.6kVDC isolation
- UL certified
- Efficiency up to 88%
- Six-sided continuous shield
- No minimum load required

# Regulated Converter



## RP15-FW

**15 Watt**  
**2" x 1"**  
**Single and Dual Output**



### Description

The RP15-FW series wide range input DC/DC converters are certified to UL 60950-1 and to cUL 60950-1. This makes them ideal for all telecom and industrial applications where approved safety standards are required. The industry standard 2" x 1" package meets military standards for thermal shock and vibration tolerance.

### Selection Guide

Part Number	Input Voltage Range (VDC)	Output Voltage (VDC)	Output Current (mA)	Input <sup>(1)</sup> Current (mA)	Efficiency <sup>(1)</sup> typ. (%)	Max. Capacitive Load <sup>(2)</sup> (µF)
RP15-243.3SFW <sup>(3,4)</sup>	9-36	3.3	4500	719	86	14700
RP15-2405SFW <sup>(3,4)</sup>	9-36	5	3000	718	87	7200
RP15-2412SFW <sup>(3,4)</sup>	9-36	12	1250	718	87	1250
RP15-2415SFW <sup>(3,4)</sup>	9-36	15	1000	718	87	800
RP15-483.3SFW <sup>(3,4)</sup>	18-75	3.3	4500	360	86	14700
RP15-4805SFW <sup>(3,4)</sup>	18-75	5	3000	355	88	7200
RP15-4812SFW <sup>(3,4)</sup>	18-75	12	1250	360	87	1250
RP15-4815SFW <sup>(3,4)</sup>	18-75	15	1000	360	87	800
RP15-2405DFW <sup>(3,4)</sup>	9-36	±5	±1500	718	87	±3600
RP15-2412DFW <sup>(3,4)</sup>	9-36	±12	±625	710	88	±625
RP15-2415DFW <sup>(3,4)</sup>	9-36	±15	±500	710	88	±400
RP15-4805DFW <sup>(3,4)</sup>	18-75	±5	±1500	355	88	±3600
RP15-4812DFW <sup>(3,4)</sup>	18-75	±12	±625	355	88	±625
RP15-4815DFW <sup>(3,4)</sup>	18-75	±15	±500	355	88	±400



UL60950-1 certified

#### Notes:

- Note1: Maximum values at nominal input voltage and full load  
 Note2: Max. Cap load is tested at minimum input and constant resistive load

### Model Numbering

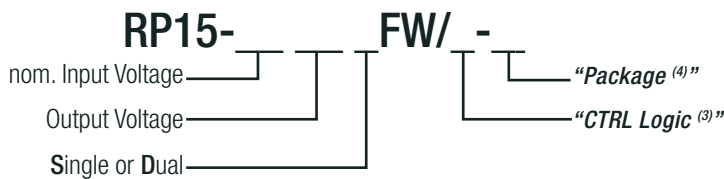

#### Notes:

- Note3: no suffix for standard part without CTRL pin  
 add suffix "P" for CTRL function with positive logic (1=ON, 0=OFF)  
 add suffix "N" for CTRL function with negative logic (0=ON, 1=OFF)  
 Note4: add suffix "-HC" for premounted Heat-sink with clips

#### Ordering Examples

- RP20-2405SFW/P = 24V input, 5V output, single, positive logic CTRL pin  
 RP20-4812DFW/N-HC = 48V input, ±12V output, dual, negative logic CTRL pin, Heat-sink premounted

**Specifications** (measured @ Ta= 25°C, nom. Vin, full load unless otherwise stated)

**BASIC CHARACTERISTICS**

Parameter	Condition		Min.	Typ.	Max.
Input Filter			Pi-Type		
Input Voltage Range	nom. Vin = 24VDC nom. Vin = 48VDC		9VDC 18VDC	24VDC 48VDC	36VDC 75VDC
Input Surge Voltage	100ms max.	nom. Vin = 24VDC nom. Vin = 48VDC			50VDC 100VDC
Under Voltage Lockout (UVLO)	nom. Vin = 24VDC	DC-DC ON DC-DC OFF		7.5VDC	9VDC
	nom. Vin = 48VDC	DC-DC ON DC-DC OFF		15VDC	18VDC
Input Reflected Ripple Current				20mA <sub>p-p</sub>	
Minimum Load			0%		
Start-up Time	Power up			20ms	
ON/OFF CTRL <sup>(5)</sup>	Positive Logic	DC-DC ON DC-DC OFF	Open or 3.0VDC < V <sub>CTRL</sub> < 12VDC Short or 0VDC < V <sub>CTRL</sub> < 1.2VDC		
	Negative Logic	DC-DC ON DC-DC OFF	Short or 0VDC < V <sub>CTRL</sub> < 1.2VDC Open or 3.0VDC < V <sub>CTRL</sub> < 12VDC		
Input Current of CTRL pin	DC-DC ON		-0.5mA		+0.5mA
Standby Current	DC-DC OFF			2.5mA	
Internal Operating Frequency			360kHz	400kHz	440kHz
Ripple and Noise	measured at 20MHz BW with a 0.1µF/50V MLCC	3.3V <sub>out</sub> , 5V <sub>out</sub> 12V <sub>out</sub> , 15V <sub>out</sub>		50mV <sub>p-p</sub> 75mV <sub>p-p</sub>	
		±5V <sub>out</sub> , ±12V <sub>out</sub> , ±15V <sub>out</sub>		75mV <sub>p-p</sub>	

**Notes:**

Note5: If no suffix is specified, the control pin will be omitted. If fitted, the ON/OFF control function can be positive or negative logic. The pin voltage is referenced to -Vin pin

**RP15-2405SF**

**Efficiency vs. Output Current**

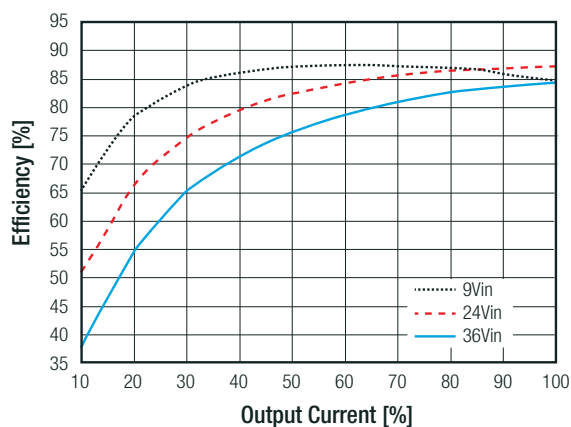

**Efficiency vs. Input Voltage full load**

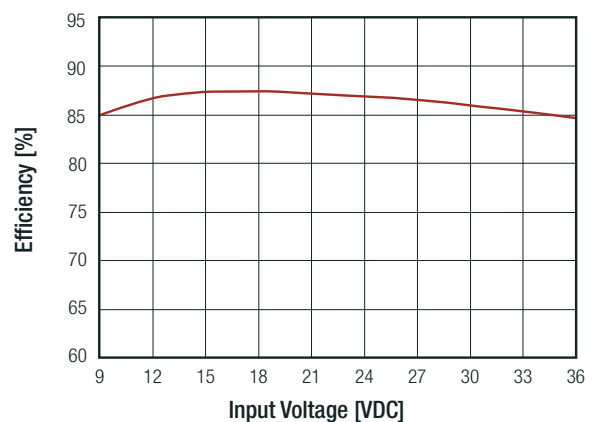

continued on next page

Specifications (measured @ Ta= 25°C, nom. Vin, full load unless otherwise stated)

RP20-4805FW

Efficiency vs. Output Current

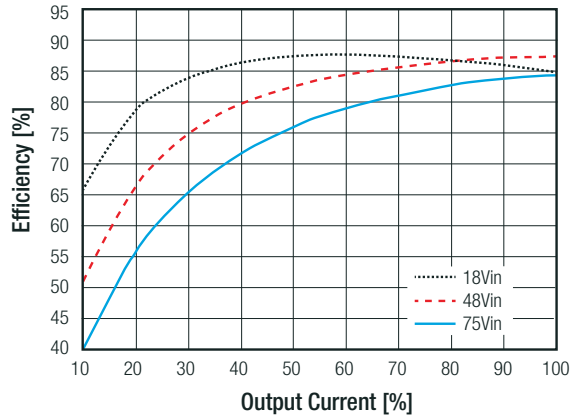

Efficiency vs. Input Voltage full load

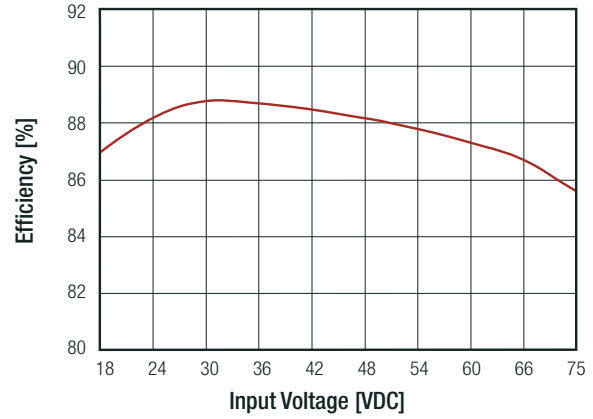

**REGULATIONS**

Parameter	Condition		Value
Output Accuracy			±1.0%
Line Regulation	low line to high line, full load	Single	±0.2%
		Dual	±0.5%
Load Regulation	0% to 100% load	Single	±0.5%
		Dual	±1.0%
Cross Regulation	asymmetrical 25%<>100% load		±5.0%
Transient Response Recovery Time	25% load step change		250µs typ.

**PROTECTIONS**

Parameter	Condition		Value
Short Circuit Protection (SCP)			continuous, automatic recovery
Over Voltage Protection (OVP)	zener diode clamp	3.3V <sub>out</sub>	3.9VDC
		5V <sub>out</sub>	6.2VDC
		12V <sub>out</sub>	15VDC
		15V <sub>out</sub>	18VDC
Over Load Protection (OLP)	% I <sub>out</sub> rated		150% typ.
Isolation Voltage <sup>(6)</sup>	I/P to O/P		1.6kVDC/ 1 minute
	I/P to O/P to case		1.6kVDC/ 1 minute
Isolation Resistance	Viso= 500VDC		1GΩ min.
Isolation Capacitance			1500pF max.

**Notes:**

Note6: For repeat Hi-Pot testing, reduce the time and/or the test voltage

Note7: This power module is not internally fused. An input line fuse must always be used

**Specifications** (measured @ Ta= 25°C, nom. Vin, full load unless otherwise stated)

**ENVIRONMENTAL**

Parameter	Condition		Value
Operating Temperature Range	without derating		-40°C to +80°C
	with derating		-40°C to +105°C
Maximum Case Temperature			+105°C
Temperature Coefficient			±0.02%/K max.
Thermal Impedance	@ natural convection	without heat-sink	12K/W
	0.1m/s	with heat-sink	10K/W
Operating Humidity	non-condensing		5% - 95% RH
Operating Altitude			2000m
Thermal Shock			according to MIL-STD-810F
Vibration			according to MIL-STD-810F
MTBF	MIL-HDBK-217F, G.B.		2430 x 10 <sup>3</sup> hours
	Bellcore TR-NWT-000332 <sup>(8)</sup>		2350 x 10 <sup>3</sup> hours

**Derating Graph <sup>(9)</sup>**

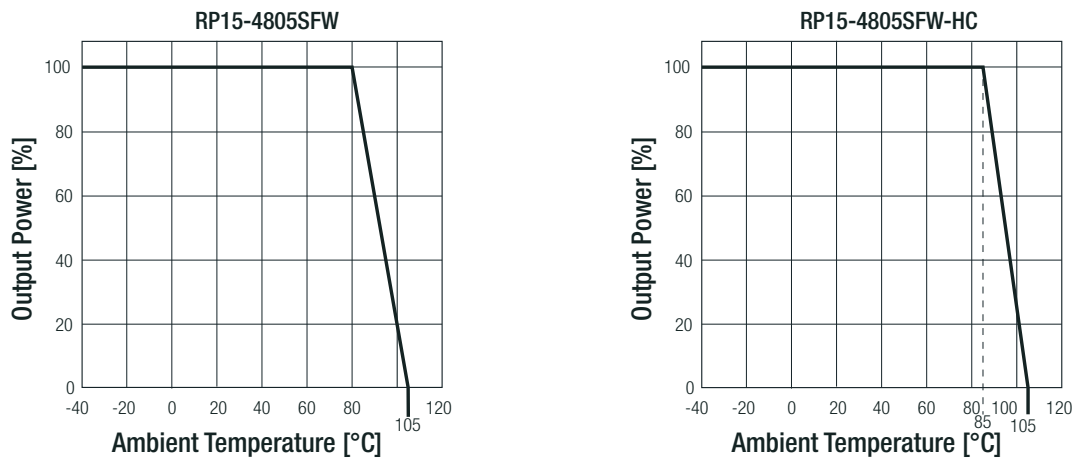

**Notes:**

- Note8: BELLCORE TR-NWT-000332. Case I: 50% Stress, Temperature at 40°C (Ground fixed and controlled environment)
- Note9: Derating graphs are valid only for the shown part numbers. If you need detailed derating-information about a part-number not shown here please contact RECOM Techsupport for detailed information

**SAFETY AND CERTIFICATIONS**

Certificate Type (Safety)	Condition	Standard
Information Technology Equipment, General Requirements for Safety	E196683	UL60950-1, 2nd Edition, 2011 CAN/CSA-C22.2 No. 60950-1-07, 2nd Edition, 2011
EAC	RU-AT.49.09571	TP TC 004/2011
RoHS2		RoHS-2011/65/EU + AM-2015/863

EMC Compliance	Condition	Standard / Criterion
Electromagnetic compatibility of multimedia equipment - Emission requirements	with external filter (see filter suggestion below)	EN55032, Class A and B
ESD Electrostatic discharge immunity test	Air ±8kV and Contact ±6kV	EN61000-4-2, Criteria B
Radiated, radio-frequency, electromagnetic field immunity test	10 V/m	EN61000-4-3, Criteria A
Fast Transient and Burst Immunity <sup>(10)</sup>	±2kV	EN61000-4-4, Criteria B
Surge Immunity <sup>(10)</sup>	±1kV	EN61000-4-5, Criteria A
Immunity to conducted disturbances, induced by radio-frequency fields	10 Vr.m.s	EN61000-4-6, Criteria A
Power Magnetic Field Immunity	100A/m continuous; 1000A/m 1s	EN61000-4-8, Criteria A

continued on next page

**Specifications** (measured @ Ta= 25°C, nom. Vin, full load unless otherwise stated)

**Notes:**

Note10 : An external input filter capacitor is required if the module has to meet EN61000-4-4, EN61000-4-5  
 Recom suggests Nippon chemi-con KY series 220µF/100V

**EMC Filtering Suggestions according to EN55032**

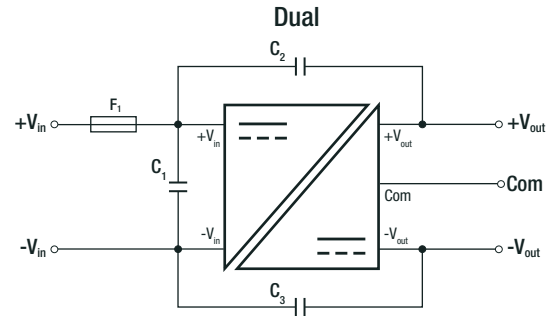
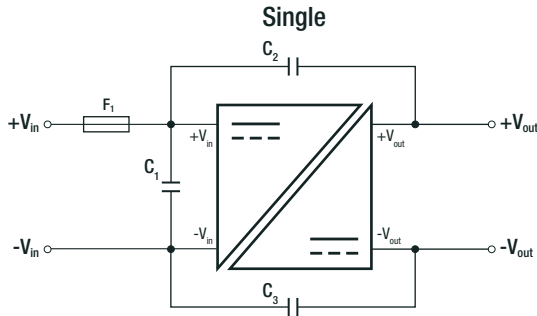

**Component List Class A**

MODEL	C1	C2	C3
RP15-24xxSFW	N/A	1000pF/2kV	1000pF/2kV
RP15-24xxDFW	N/A	1206 MLCC	1206 MLCC
RP15-48xxSFW	1µF/100V	1000pF/2kV	1000pF/2kV
RP15-48xxDFW	1210 MLCC	1206 MLCC	1206 MLCC

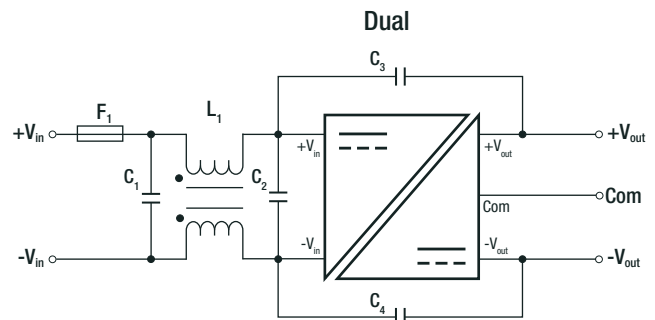
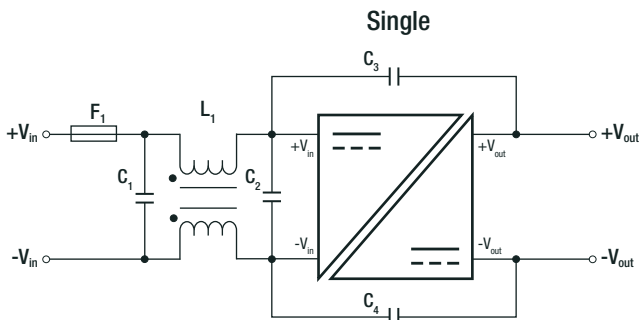

**Component List Class B**

MODEL	C1	C2	C3/C4	L1
RP15-24xxSFW	2.2µF/50V	N/A	1000pF/2kV	CMC: 450µH
RP15-24xxDFW	1812 MLCC	N/A	1206 MLCC	ref.: WE 7448227005 ref.: CMC-05
RP15-48xxSFW	2.2µF/50V	2.2µF/50V	1000pF/2kV	CMC: 325µH
RP15-48xxDFW	1812 MLCC	1812 MLCC	1206 MLCC	ref.: WE 744290321 ref.: CMC-06

**DIMENSIONS and PHYSICAL CHARACTERISTICS**

Parameter	Type	Value
Material	case	nickel coated copper
	base	FR4 PCB
	potting	epoxy (UL94V-0)
Dimensions (LxWxH)	without Heat-sink	50.8 x 25.4 x 10.2mm
	with Heat-sink	56.8 x 25.4 x 16.8mm
Weight	without Heat-sink	27g
	with Heat-sink	37.89g

continued on next page

Specifications (measured @ Ta= 25°C, nom. Vin, full load unless otherwise stated)

### Dimension Drawing (mm)

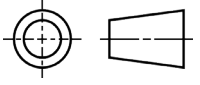
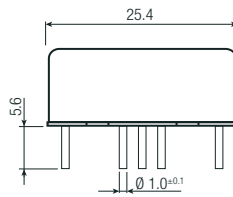
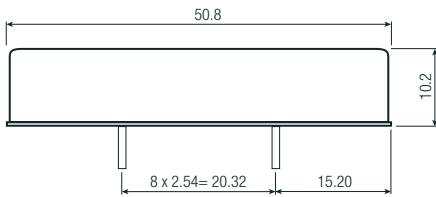

### Pinning Information

Pin #	Single	Dual
1	+Vin	+Vin
2	-Vin	-Vin
3	+Vout	+Vout
4	no Pin	Com
5	-Vout	-Vout
6	CTRL <sup>(3)</sup>	CTRL <sup>(3)</sup>

Tolerance: xx.x= ±0.5mm  
xx.xx= ±0.25mm

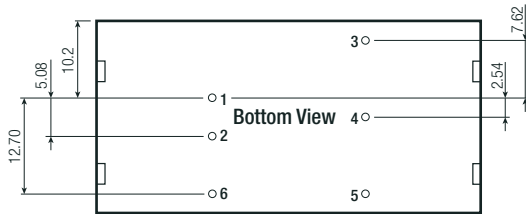

### Recommended Footprint Details

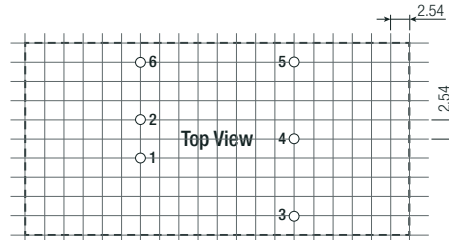

### Dimension Drawing with Heat-sink (mm)

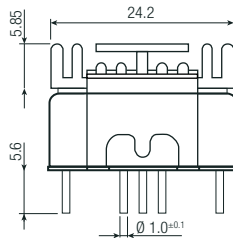
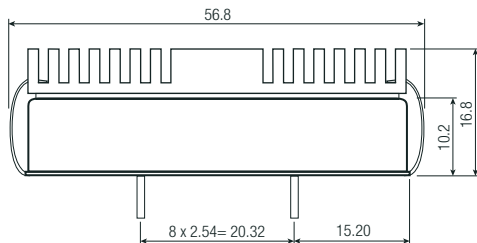
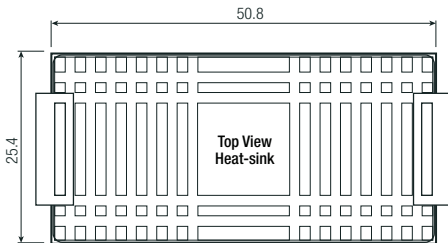

### Recommended Footprint Details

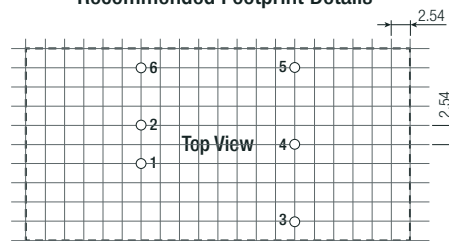
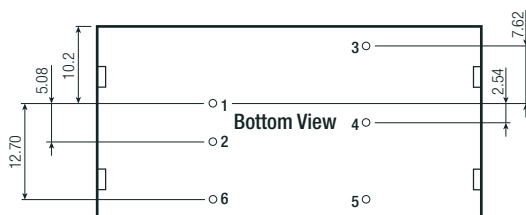



**Specifications** (measured @ Ta= 25°C, nom. Vin, full load unless otherwise stated)

PACKAGING INFORMATION			
Parameter	Type		Value
Packaging Dimension (LxWxH)	tube	without heat-sink	255.0 x 54.0 x 22.0mm
	tray	with heat-sink	302.5 x 222.0 x 20.0mm
Packaging Quantity	tube	without heat-sink	9pcs
	tray	with heat-sink	20pcs
Storage Temperature Range			-55°C to +125°C
Storage Humidity	non-condensing		5% - 95% RH

The product information and specifications may be subject to changes even without prior written notice. The product has been designed for various applications; its suitability lies in the responsibility of each customer. The products are not authorized for use in safety-critical applications without RECOM's explicit written consent. A safety-critical application is an application where a failure may reasonably be expected to endanger or cause loss of life, inflict bodily harm or damage property. The applicant shall indemnify and hold harmless RECOM, its affiliated companies and its representatives against any damage claims in connection with the unauthorized use of RECOM products in such safety-critical applications.

## Looking for pricing, stock, or lifecycle information?

Click below to explore more details on WIN SOURCE:

-  [View RP15-2405SFW on WIN SOURCE](#)
-  [Recom Power Information](#)

## Optimize Your Supply Chain with WIN SOURCE Solutions

-  Global Sourcing Solution
-  Obsolete Management
-  Cost Control Management
-  Shortage Management
-  Alternative Solution
-  Excess Inventory Management