



**THE DATASHEET OF
BFC237954244**





AC and Pulse Metallized Polypropylene Film Capacitors MKP Radial Potted Type

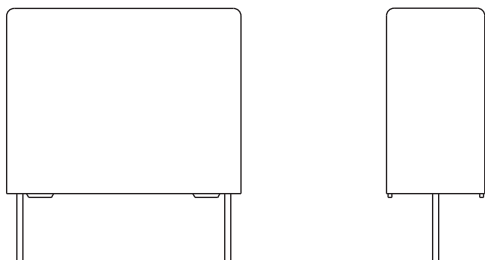

FEATURES

- Low loss dielectric
- Material categorization:
for definitions of compliance please see www.vishay.com/doc?99912

APPLICATIONS

Low losses due to low contact resistance and low loss dielectric make these products suitable for applications where high currents at high frequency occur or high stability is preferred. Their small dimensions make them ideal for circuits with high packaging density.



QUICK REFERENCE DATA	
Capacitance range (E24 series)	0.01 μ F to 6.2 μ F
Capacitance tolerance	\pm 5 %
Climatic category	55/085/56
Maximum application temperature	85 °C
Reference specifications	IEC 60384-17
Dielectric	Polypropylene film
Electrodes	Metallized film
Construction	Wound mono construction
Encapsulation	Flame retardant plastic case and epoxy resin (UL-class 94 V-0)
Leads	Tinned wire
Marking	C-value; tolerance; rated voltage; manufacturer's type designation; code for dielectric material; manufacturer's emblem; code for factory of origin; year and week of manufacture
Rated DC voltage	160 V _{DC} ; 250 V _{DC} ; 400 V _{DC} ; 630 V _{DC}
Rated AC voltage	100 V _{AC} ; 160 V _{AC} ; 200 V _{AC} ; 220 V _{AC}
Rated peak-to-peak voltage	280 V; 450 V; 560 V; 620 V
Rated temperature	85 °C
Performance grade	Grade 1 (long life)
Stability grade	160 V versions: grade 2 250 V to 630 V versions; pitch 5 mm to 15 mm: grade 2 250 V to 630 V versions; pitch 22.5 mm and 27.5 mm: grade 1

Note

- For more detailed data and test requirements contact dc-film@vishay.com

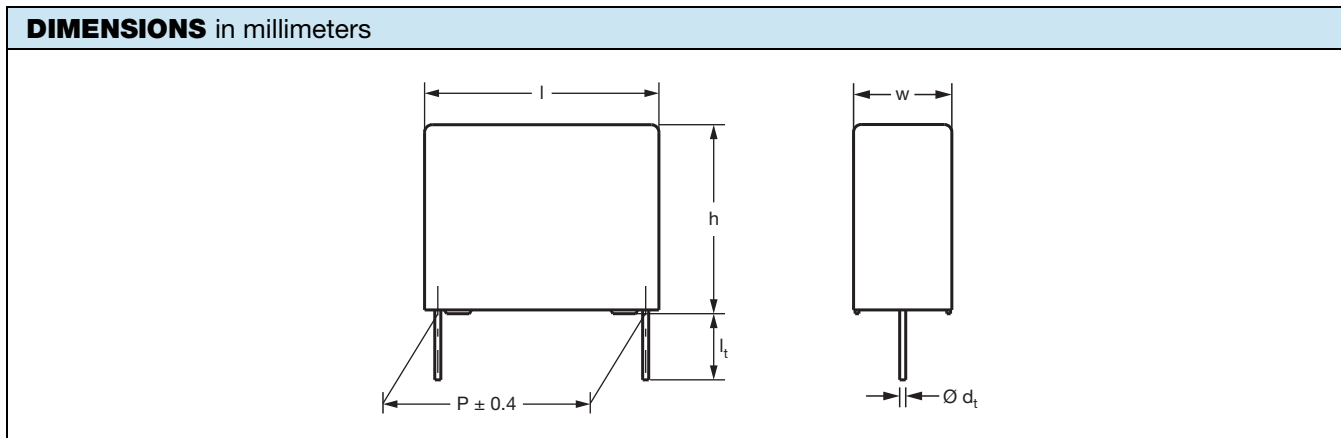

COMPOSITION OF CATALOG NUMBER

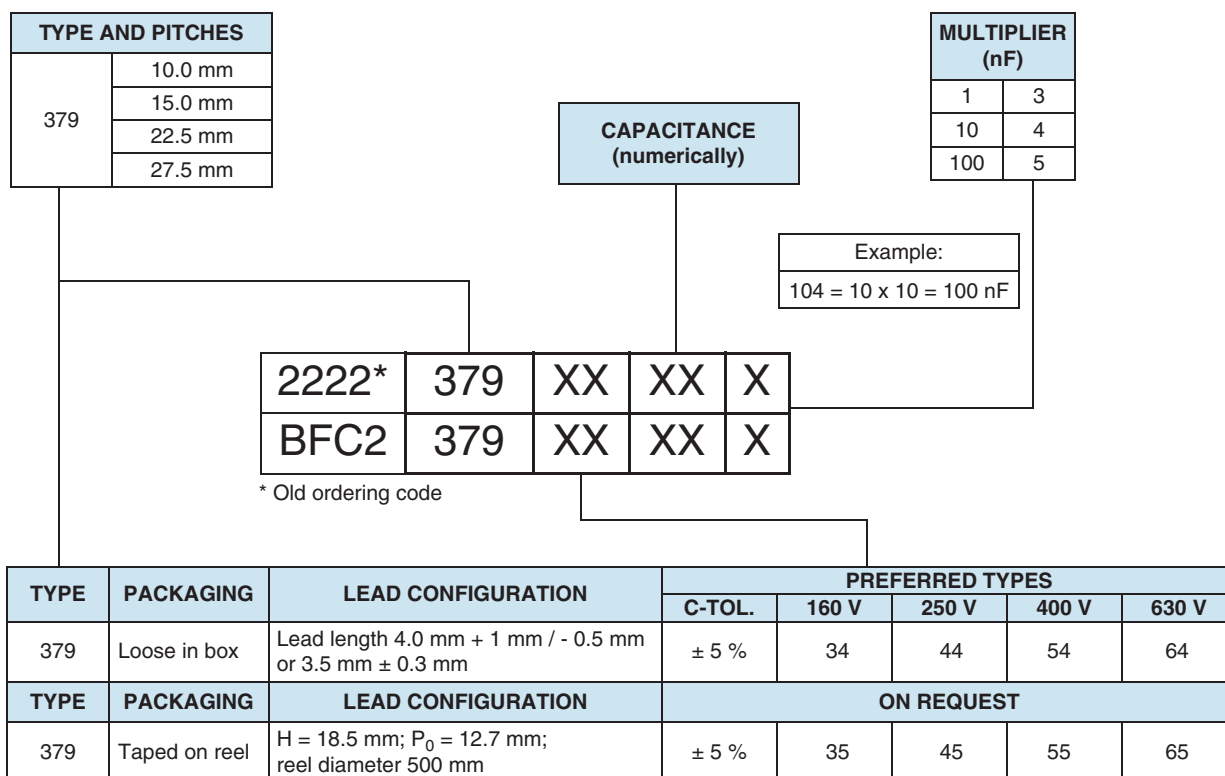



SPECIFIC REFERENCE DATA - 160 V _{DC}		
DESCRIPTION	VALUE	
	at 10 kHz	at 100 kHz
Tangent of loss angle:		
C ≤ 0.075 μF	≤ 10 x 10 ⁻⁴	≤ 20 x 10 ⁻⁴
0.075 μF < C ≤ 0.11 μF	≤ 10 x 10 ⁻⁴	≤ 25 x 10 ⁻⁴
0.11 μF < C ≤ 0.16 μF	≤ 10 x 10 ⁻⁴	≤ 30 x 10 ⁻⁴
0.18 μF < C ≤ 0.30 μF	≤ 10 x 10 ⁻⁴	≤ 40 x 10 ⁻⁴
0.30 μF < C ≤ 0.39 μF	≤ 10 x 10 ⁻⁴	≤ 45 x 10 ⁻⁴
0.39 μF < C ≤ 0.56 μF	≤ 10 x 10 ⁻⁴	≤ 45 x 10 ⁻⁴
0.56 μF < C ≤ 0.68 μF	≤ 15 x 10 ⁻⁴	≤ 80 x 10 ⁻⁴
0.68 μF < C ≤ 0.82 μF	≤ 15 x 10 ⁻⁴	≤ 80 x 10 ⁻⁴
0.82 μF < C ≤ 0.91 μF	≤ 15 x 10 ⁻⁴	≤ 90 x 10 ⁻⁴
0.91 μF < C ≤ 1.0 μF	≤ 15 x 10 ⁻⁴	≤ 90 x 10 ⁻⁴
1.0 μF < C ≤ 1.2 μF	≤ 15 x 10 ⁻⁴	≤ 120 x 10 ⁻⁴
1.2 μF < C ≤ 1.3 μF	≤ 15 x 10 ⁻⁴	≤ 125 x 10 ⁻⁴
1.3 μF < C ≤ 1.5 μF	≤ 15 x 10 ⁻⁴	≤ 135 x 10 ⁻⁴
1.5 μF < C ≤ 1.6 μF	≤ 15 x 10 ⁻⁴	≤ 135 x 10 ⁻⁴
1.6 μF < C ≤ 1.8 μF	≤ 15 x 10 ⁻⁴	≤ 135 x 10 ⁻⁴
1.8 μF < C ≤ 2.0 μF	≤ 15 x 10 ⁻⁴	≤ 145 x 10 ⁻⁴
2.0 μF < C ≤ 2.2 μF	≤ 15 x 10 ⁻⁴	≤ 145 x 10 ⁻⁴
2.2 μF < C ≤ 2.4 μF	≤ 15 x 10 ⁻⁴	≤ 145 x 10 ⁻⁴
2.4 μF < C ≤ 2.7 μF	≤ 15 x 10 ⁻⁴	≤ 155 x 10 ⁻⁴
2.7 μF < C ≤ 3.0 μF	≤ 15 x 10 ⁻⁴	≤ 155 x 10 ⁻⁴
3.0 μF < C ≤ 3.3 μF	≤ 20 x 10 ⁻⁴	≤ 160 x 10 ⁻⁴
3.3 μF < C ≤ 3.6 μF	≤ 20 x 10 ⁻⁴	≤ 160 x 10 ⁻⁴
3.6 μF < C ≤ 3.9 μF	≤ 20 x 10 ⁻⁴	≤ 160 x 10 ⁻⁴
3.9 μF < C ≤ 4.3 μF	≤ 20 x 10 ⁻⁴	≤ 165 x 10 ⁻⁴
4.3 μF < C ≤ 4.7 μF	≤ 20 x 10 ⁻⁴	≤ 165 x 10 ⁻⁴
4.7 μF < C ≤ 5.1 μF	≤ 20 x 10 ⁻⁴	≤ 165 x 10 ⁻⁴
5.1 μF < C ≤ 5.6 μF	≤ 20 x 10 ⁻⁴	≤ 175 x 10 ⁻⁴
5.6 μF < C ≤ 6.2 μF	≤ 40 x 10 ⁻⁴	≤ 195 x 10 ⁻⁴
Rated voltage pulse slope (dU/dt) _R :		
l = 12.5 mm		60 V/μs
l = 17.5 mm		50 V/μs
l = 26.0 mm		25 V/μs
l = 31.0 mm		15 V/μs (b < 15 mm)
l = 31.0 mm		7.5 V/μs (b ≥ 15 mm)
R between leads for C ≤ 1.0 μF at 100 V; 1 min		> 100 000 MΩ
RC between leads, for C > 1 μF at 100 V; 1 min		> 100 000 s
R between interconnected leads and case; 100 V; 1 min		> 100 000 MΩ
Withstanding (DC) voltage (cut off current 10 mA) ⁽¹⁾ ; rise time ≤ 1000 V/s		256 V; 1 min
Withstanding (DC) voltage between leads and case		2840 V; 1 min

Note

⁽¹⁾ See "Voltage Proof Test for Metalized Film Capacitors": www.vishay.com/doc?28169



ELECTRICAL DATA AND ORDERING CODE							
U_{RDC} (V)	CAP. (μF)	DIMENSIONS w x h x l (mm)	MASS ⁽³⁾ (g)	CATALOG NUMBER BFC2 379 AND PACKAGING			
				LOOSE IN BOX		REEL ⁽²⁾	
				l_t = 4.0 mm + 1.0 mm/- 0.5 mm ⁽¹⁾		H = 18.5 mm, P₀ = 12.7 mm	
				C-TOL. = ± 5 %	SPQ	SPQ	
LAST 5 DIGITS OF CATALOG NUMBER							
PITCH = 10.0 mm ± 0.4 mm; d_t = 0.60 mm ± 0.06 mm; U_{RAC} = 100 V; U_{p-p} = 280 V							
160	0.075	4.0 x 10.0 x 12.5	0.60	34753	1000	1400	
	0.082			34823			
	0.091			34913			
	0.10			34104			
	0.11			34114			
	0.12	34124	1100				
	0.13	34134					
	0.15	34154					
	0.16	5.0 x 11.0 x 12.5	0.82	34164	1000	900	
	PITCH = 15.0 mm ± 0.4 mm; d_t = 0.60 mm ± 0.06 mm; U_{RAC} = 100 V; U_{p-p} = 280 V						
	160	0.18	5.0 x 11.0 x 17.5	1.0	34184	1000	1100
		0.20			34204		
		0.22			34224		
		0.24			34244		
		0.27			34274		
		0.30	34304	900			
0.33		6.0 x 12.0 x 17.5	1.4	34334	1000	900	
0.36				34364			
0.39				34394			
0.43				34434			
0.47	34474	800					
PITCH = 15.0 mm ± 0.4 mm; d_t = 0.80 mm ± 0.08 mm; U_{RAC} = 100 V; U_{p-p} = 280 V							
160	0.51	7.0 x 13.5 x 17.5	1.8	34514	1000	800	
	0.56			34564		650	
	0.62			34624			
	0.68	8.5 x 15.0 x 17.5	2.4	34684	1000	650	
	0.75			34754			
PITCH = 22.5 mm ± 0.4 mm; d_t = 0.80 mm ± 0.08 mm; U_{RAC} = 100 V; U_{p-p} = 280 V							
160	0.82	6.0 x 15.5 x 26.0	2.4	34824	200	550	
	0.91			34914			
	1.0	7.0 x 16.5 x 26.0	2.9	34105	200	450	
	1.1			34115			
	1.2			34125			
	1.3	8.5 x 18.0 x 26.0	3.8	34135	200	450	
	1.5			34155		350	
	1.6			34165			
	1.8			34185			
	PITCH = 27.5 mm ± 0.4 mm; d_t = 0.80 mm ± 0.08 mm; U_{RAC} = 100 V; U_{p-p} = 280 V						
	160	2.0	9.0 x 19.0 x 31.5	5.5	34205	100	
		2.2			34225		
		2.4	11.0 x 21.0 x 31.0	7.4	34245	100	
		2.7			34275		
3.0		34305					
3.3		34335					
3.6		13.0 x 23.0 x 31.0	9.2	34365	100		
3.9				34395			
4.3				34435			
4.7		15.0 x 25.0 x 31.5	12.3	34475	100		
5.1	34515						
5.6	34565						
6.2	18.0 x 28.0 x 31.5	16.1	34625	100			

Notes

- SPQ = Standard Packing Quantity
- (1) l_t = 4.0 mm + 1 mm / - 0.5 mm for pitch = 10 mm and 3.5 mm ± 0.3 mm for pitch = 15 mm; 22.5 mm and 27.5 mm.
- (2) H = in-tape height; P₀ = sprocket hole distance; for detailed specifications refer to packaging information: www.vishay.com/doc?28139
- (3) Weight for short lead product only



SPECIFIC REFERENCE DATA - 250 V _{DC}		
DESCRIPTION	VALUE	
	at 10 kHz	at 100 kHz
Tangent of loss angle:		
0.047 μF < C ≤ 0.075 μF	≤ 5 x 10 ⁻⁴	≤ 20 x 10 ⁻⁴
0.075 μF < C ≤ 0.011 μF	≤ 5 x 10 ⁻⁴	≤ 25 x 10 ⁻⁴
0.11 μF < C ≤ 0.18 μF	≤ 10 x 10 ⁻⁴	≤ 30 x 10 ⁻⁴
0.18 μF < C ≤ 0.3 μF	≤ 10 x 10 ⁻⁴	≤ 40 x 10 ⁻⁴
0.30 μF < C ≤ 0.39 μF	≤ 10 x 10 ⁻⁴	≤ 45 x 10 ⁻⁴
0.39 μF < C ≤ 0.56 μF	≤ 15 x 10 ⁻⁴	≤ 80 x 10 ⁻⁴
0.56 μF < C ≤ 0.68 μF	≤ 15 x 10 ⁻⁴	≤ 80 x 10 ⁻⁴
0.68 μF < C ≤ 0.82 μF	≤ 15 x 10 ⁻⁴	≤ 80 x 10 ⁻⁴
0.82 μF < C ≤ 0.91 μF	≤ 15 x 10 ⁻⁴	≤ 90 x 10 ⁻⁴
0.91 μF < C ≤ 1.0 μF	≤ 15 x 10 ⁻⁴	≤ 90 x 10 ⁻⁴
1.0 μF < C ≤ 1.2 μF	≤ 15 x 10 ⁻⁴	≤ 120 x 10 ⁻⁴
1.2 μF < C ≤ 1.3 μF	≤ 15 x 10 ⁻⁴	≤ 125 x 10 ⁻⁴
1.3 μF < C ≤ 1.5 μF	≤ 15 x 10 ⁻⁴	≤ 135 x 10 ⁻⁴
1.5 μF < C ≤ 1.6 μF	≤ 15 x 10 ⁻⁴	≤ 135 x 10 ⁻⁴
1.6 μF < C ≤ 1.8 μF	≤ 15 x 10 ⁻⁴	≤ 135 x 10 ⁻⁴
1.8 μF < C ≤ 2.0 μF	≤ 15 x 10 ⁻⁴	≤ 145 x 10 ⁻⁴
2.0 μF < C ≤ 2.2 μF	≤ 10 x 10 ⁻⁴	≤ 145 x 10 ⁻⁴
2.2 μF < C ≤ 2.4 μF	≤ 15 x 10 ⁻⁴	≤ 145 x 10 ⁻⁴
2.4 μF < C ≤ 2.7 μF	≤ 15 x 10 ⁻⁴	≤ 155 x 10 ⁻⁴
2.7 μF < C ≤ 3.0 μF	≤ 15 x 10 ⁻⁴	≤ 155 x 10 ⁻⁴
3.0 μF < C ≤ 3.3 μF	≤ 20 x 10 ⁻⁴	≤ 160 x 10 ⁻⁴
3.3 μF < C ≤ 3.6 μF	≤ 20 x 10 ⁻⁴	≤ 160 x 10 ⁻⁴
3.6 μF < C ≤ 3.9 μF	≤ 20 x 10 ⁻⁴	≤ 160 x 10 ⁻⁴
Rated voltage pulse slope (dU/dt) _R :		
l = 12.5 mm		70 V/μs
l = 17.5 mm		60 V/μs
l = 26.0 mm		30 V/μs
l = 31.0 mm		20 V/μs (b < 15 mm)
l = 31.0 mm		10 V/μs (b ≥ 15 mm)
R between leads for C ≤ 1.0 μF at 100 V; 1 min		> 100 000 MΩ
RC between leads, for C > 1 μF at 100 V; 1 min		> 100 000 s
R between interconnected leads and case; 100 V; 1 min		> 100 000 MΩ
Withstanding (DC) voltage (cut off current 10 mA) ⁽¹⁾ ; rise time 1000 V/s		400 V; 1 min
Withstanding (DC) voltage between leads and case		2840 V; 1 min

Note

⁽¹⁾ See "Voltage Proof Test for Metalized Film Capacitors": www.vishay.com/doc?28169



ELECTRICAL DATA AND ORDERING CODE						
U _{RDC} (V)	CAP. (μF)	DIMENSIONS w x h x l (mm)	MASS ⁽³⁾ (g)	CATALOG NUMBER BFC2 379 AND PACKAGING		
				LOOSE IN BOX		REEL ⁽²⁾
				l _t = 4.0 mm + 1.0 mm / - 0.5 mm ⁽¹⁾		H = 18.5 mm, P ₀ = 12.7 mm
				C-TOL. = ± 5 %	SPQ	SPQ
LAST 5 DIGITS OF CATALOG NUMBER						
250	PITCH = 10.0 mm ± 0.4 mm; d _t = 0.60 mm ± 0.06 mm; U _{RAC} = 160 V; U _{p-p} = 450 V					
	0.047	4.0 x 10.0 x 12.5	0.60	44473	1000	1400
	0.051			44513		
	0.056			44563		
	0.062			44623		
	0.068			44683		
	0.075			44753		
	0.082	44823	1100			
	0.091	44913				
	PITCH = 15.0 mm ± 0.4 mm; d _t = 0.60 mm ± 0.06 mm; U _{RAC} = 160 V; U _{p-p} = 450 V					
	0.10	5.0 x 11.0 x 17.5	1.0	44104	1000	1100
	0.11			44114		
	0.12			44124		
	0.13			44134		
	0.15			44154		
	0.16			44164		
	0.18	44184	900			
	0.20	44204				
	0.22	44224				
	0.24	44244				
	0.27	6.0 x 12.0 x 17.5	1.4	44274	1000	800
	0.30			44304		
	0.33			44334		
	0.36			44364		
	PITCH = 15.0 mm ± 0.4 mm; d _t = 0.80 mm ± 0.08 mm; U _{RAC} = 160 V; U _{p-p} = 450 V					
	0.39	7.0 x 13.5 x 17.5	1.8	44394	1000	650
	0.43			44434		
	0.47			44474		
	PITCH = 22.5 mm ± 0.4 mm; d _t = 0.80 mm ± 0.08 mm; U _{RAC} = 160 V; U _{p-p} = 450 V					
	0.51	6.0 x 15.5 x 26.0	2.4	44514	200	550
	0.56			44564		
	0.62			44624		
0.68	44684					
0.75	7.0 x 16.5 x 26.0	2.9	44754	200	450	
0.82			44824			
0.91			44914			
1.0			44105			
1.1	8.5 x 18.0 x 26.0	3.8	44115	200	350	
1.2			44125			
PITCH = 27.5 mm ± 0.4 mm; d _t = 0.80 mm ± 0.08 mm; U _{RAC} = 160 V; U _{p-p} = 450 V						
1.3	9.0 x 19.0 x 31.5	5.5	44135	100		
1.5			44155			
1.6			44165			
1.8			44185			
2.0	11.0 x 21.0 x 31.0	7.4	44205	100		
2.2			44225			
2.4			44245			
2.7			44275			
3.0			44305			
3.3	13.0 x 23.0 x 31.0	9.2	44335	100		
3.6			44365			
3.9			44395			

Notes

• SPQ = Standard Packing Quantity

(1) l_t = 4.0 mm + 1 mm / - 0.5 mm for pitch = 10 mm and 3.5 mm ± 0.3 mm for pitch = 15 mm; 22.5 mm and 27.5 mm.

(2) H = in-tape height; P₀ = sprocket hole distance; for detailed specifications refer to packaging information: www.vishay.com/doc?28139

(3) Weight for short lead product only



SPECIFIC REFERENCE DATA - 400 V _{DC}		
DESCRIPTION	VALUE	
	at 10 kHz	at 100 kHz
Tangent of loss angle:		
0.022 μF < C ≤ 0.027 μF	≤ 10 x 10 ⁻⁴	≤ 15 x 10 ⁻⁴
0.027 μF < C ≤ 0.075 μF	≤ 10 x 10 ⁻⁴	≤ 20 x 10 ⁻⁴
0.075 μF < C ≤ 0.11 μF	≤ 10 x 10 ⁻⁴	≤ 25 x 10 ⁻⁴
0.11 μF < C ≤ 0.18 μF	≤ 10 x 10 ⁻⁴	≤ 30 x 10 ⁻⁴
0.18 μF < C ≤ 0.3 μF	≤ 10 x 10 ⁻⁴	≤ 40 x 10 ⁻⁴
0.30 μF < C ≤ 0.39 μF	≤ 10 x 10 ⁻⁴	≤ 45 x 10 ⁻⁴
0.39 μF < C ≤ 0.56 μF	≤ 15 x 10 ⁻⁴	≤ 80 x 10 ⁻⁴
0.56 μF < C ≤ 0.68 μF	≤ 15 x 10 ⁻⁴	≤ 80 x 10 ⁻⁴
0.68 μF < C ≤ 0.82 μF	≤ 15 x 10 ⁻⁴	≤ 80 x 10 ⁻⁴
0.82 μF < C ≤ 0.91 μF	≤ 15 x 10 ⁻⁴	≤ 90 x 10 ⁻⁴
0.91 μF < C ≤ 1.0 μF	≤ 15 x 10 ⁻⁴	≤ 90 x 10 ⁻⁴
1.0 μF < C ≤ 1.2 μF	≤ 15 x 10 ⁻⁴	≤ 120 x 10 ⁻⁴
1.2 μF < C ≤ 1.3 μF	≤ 15 x 10 ⁻⁴	≤ 125 x 10 ⁻⁴
1.3 μF < C ≤ 1.5 μF	≤ 15 x 10 ⁻⁴	≤ 135 x 10 ⁻⁴
1.5 μF < C ≤ 1.6 μF	≤ 15 x 10 ⁻⁴	≤ 135 x 10 ⁻⁴
1.6 μF < C ≤ 1.8 μF	≤ 15 x 10 ⁻⁴	≤ 135 x 10 ⁻⁴
1.8 μF < C ≤ 2.0 μF	≤ 15 x 10 ⁻⁴	≤ 145 x 10 ⁻⁴
Rated voltage pulse slope (dU/dt) _R :		
l = 12.5 mm		80 V/μs
l = 17.5 mm		70 V/μs
l = 26.0 mm		35 V/μs
l = 31.0 mm		25 V/μs (b < 15 mm)
l = 31.0 mm		13 V/μs (b ≥ 15 mm)
R between leads for C ≤ 1.0 μF at 100 V; 1 min		> 100 000 MΩ
RC between leads, for C > 1 μF at 100 V; 1 min		> 100 000 s
R between interconnected leads and case; 100 V; 1 min		> 100 000 MΩ
Withstanding (DC) voltage (cut off current 10 mA) ⁽¹⁾ ; rise time 1000 V/s		640 V; 1 min
Withstanding (DC) voltage between leads and case		2840 V; 1 min

Note

⁽¹⁾ See "Voltage Proof Test for Metalized Film Capacitors": www.vishay.com/doc?28169



ELECTRICAL DATA AND ORDERING CODE							
U _{RDC} (V)	CAP. (μF)	DIMENSIONS w x h x l (mm)	MASS ⁽³⁾ (g)	CATALOG NUMBER BFC2 379 AND PACKAGING			
				LOOSE IN BOX		REEL ⁽²⁾	
				l _t = 4.0 mm + 1.0 mm/- 0.5 mm ⁽¹⁾		H = 18.5 mm, P ₀ = 12.7 mm	
				C-TOL. = ± 5 %	SPQ	SPQ	
LAST 5 DIGITS OF CATALOG NUMBER							
PITCH = 10.0 mm ± 0.4 mm; d_t = 0.60 mm ± 0.06 mm; U_{RAC} = 200 V; U_{p-p} = 560 V							
400	0.022	4.0 x 10.0 x 12.5	0.60	54223	1000	1400	
	0.024			54243			
	0.027			54273			
	0.030			54303			
	0.033			54333			
	0.036			54363			
	0.039	54393	1100				
	0.043	54433					
	PITCH = 15.0 mm ± 0.4 mm; d_t = 0.60 mm ± 0.06 mm; U_{RAC} = 200 V; U_{p-p} = 560 V						
	0.047	5.0 x 11.0 x 17.5	1.0	54473	1000	1100	
	0.051			54513			
	0.056			54563			
	0.062			54623			
	0.068			54683			
	0.075			54753			
	0.082	54823	900				
	0.091	54913					
	0.10	54104					
0.11	54114						
0.12	54124	800					
0.13	54134						
0.15	54154						
0.16	54164	650					
0.18	54184						
PITCH = 15.0 mm ± 0.4 mm; d_t = 0.80 mm ± 0.08 mm; U_{RAC} = 200 V; U_{p-p} = 560 V							
0.20	7.0 x 13.5 x 17.5	1.8	54204	1000	650		
			54224				
PITCH = 22.5 mm ± 0.4 mm; d_t = 0.80 mm ± 0.08 mm; U_{RAC} = 200 V; U_{p-p} = 560 V							
0.24	6.0 x 15.5 x 26.0	2.4	54244	200	550		
0.27			54274				
0.30			54304				
0.33	7.0 x 16.5 x 26.0	2.9	54334	200	450		
0.36			54364				
0.39			54394				
0.43			54434				
0.47			54474				
0.51			54514			350	
0.56	54564						
0.62	54624						
PITCH = 27.5 mm ± 0.4 mm; d_t = 0.80 mm ± 0.08 mm; U_{RAC} = 200 V; U_{p-p} = 560 V							
0.68	9.0 x 19.0 x 31.5	5.5	54684	100			
0.75			54754				
0.82			54824				
0.91	11.0 x 21.0 x 31.0	7.4	54914	100			
1.0			54105				
1.1			54115				
1.2			54125				
1.3			54135				
1.5			54155			100	
1.6	54165						
1.8	54185						
2.0	15.0 x 25.0 x 31.5	12.3	54205	100			

Notes

- SPQ = Standard Packing Quantity
- (1) l_t = 4.0 mm + 1 mm / - 0.5 mm for pitch = 10 mm and 3.5 mm ± 0.3 mm for pitch = 15 mm; 22.5 mm and 27.5 mm.
- (2) H = in-tape height; P₀ = sprocket hole distance; for detailed specifications refer to packaging information: www.vishay.com/doc?28139
- (3) Weight for short lead product only



SPECIFIC REFERENCE DATA - 630 V _{DC}		
DESCRIPTION	VALUE	
	at 10 kHz	at 100 kHz
Tangent of loss angle:		
0.010 μF < C ≤ 0.027 μF	≤ 10 x 10 ⁻⁴	≤ 15 x 10 ⁻⁴
0.027 μF < C ≤ 0.075 μF	≤ 10 x 10 ⁻⁴	≤ 20 x 10 ⁻⁴
0.075 μF < C ≤ 0.11 μF	≤ 10 x 10 ⁻⁴	≤ 25 x 10 ⁻⁴
0.11 μF < C ≤ 0.18 μF	≤ 10 x 10 ⁻⁴	≤ 30 x 10 ⁻⁴
0.18 μF < C ≤ 0.30 μF	≤ 10 x 10 ⁻⁴	≤ 40 x 10 ⁻⁴
0.30 μF < C ≤ 0.39 μF	≤ 10 x 10 ⁻⁴	≤ 40 x 10 ⁻⁴
0.39 μF < C ≤ 0.56 μF	≤ 10 x 10 ⁻⁴	≤ 45 x 10 ⁻⁴
0.56 μF < C ≤ 0.68 μF	≤ 15 x 10 ⁻⁴	≤ 80 x 10 ⁻⁴
0.68 μF < C ≤ 0.82 μF	≤ 15 x 10 ⁻⁴	≤ 80 x 10 ⁻⁴
0.82 μF < C ≤ 1.0 μF	≤ 15 x 10 ⁻⁴	≤ 90 x 10 ⁻⁴
Rated voltage pulse slope (dU/dt) _R :		
l = 12.5 mm		100 V/μs
l = 17.5 mm		90 V/μs
l = 26.0 mm		45 V/μs
l = 31.0 mm		30 V/μs (b < 15 mm)
l = 31.0 mm		15 V/μs (b ≥ 15 mm)
R between leads for C ≤ 1.0 μF at 500 V; 1 min		> 100 000 MΩ
RC between leads, for C > 1 μF at 100 V; 1 min		> 100 000 s
R between interconnected leads and case; 500 V; 1 min		> 100 000 MΩ
Withstanding (DC) voltage (cut off current 10 mA) ⁽¹⁾ ; rise time 1000 V/s		960 V; 1 min
Withstanding (DC) voltage between leads and case		2840 V; 1 min

Note

⁽¹⁾ See "Voltage Proof Test for Metalized Film Capacitors": www.vishay.com/doc?28169



ELECTRICAL DATA AND ORDERING CODE							
U _{RDC} (V)	CAP. (μF)	DIMENSIONS w x h x l (mm)	MASS ⁽³⁾ (g)	CATALOG NUMBER BFC2 379 AND PACKAGING			
				LOOSE IN BOX		REEL ⁽²⁾	
				l _t = 4.0 mm + 1.0 mm / - 0.5 mm ⁽¹⁾		H = 18.5 mm, P ₀ = 12.7 mm	
				C-TOL. = ± 5 %	SPQ	SPQ	
LAST 5 DIGITS OF CATALOG NUMBER							
630	PITCH = 10.0 mm ± 0.4 mm; d _t = 0.60 mm ± 0.06 mm; U _{RAC} = 220 V; U _{p-p} = 620 V						
	0.010	4.0 x 10.0 x 12.5	0.60	64103	1000	1400	
	0.011			64113			
	0.012			64123			
	0.013			64133			
	0.015			64153			
	0.016			64163			
	0.018	64183	1100				
	0.020	64203					
	0.022	64223					
	0.024	64243					
	PITCH = 15.0 mm ± 0.4 mm; d _t = 0.60 mm ± 0.06 mm; U _{RAC} = 220 V; U _{p-p} = 620 V						
	0.027	5.0 x 11.0 x 17.5		1.0	64273	1000	1100
	0.030		64303				
	0.033		64333				
	0.036		64363				
	0.039		64393				
	0.043		64433		900		
	0.047	64473					
	0.051	64513					
	0.056	64563					
	0.062	64623					
	0.068	64683	800				
	0.075	6.0 x 12.0 x 17.5	1.4	64753	1000	800	
	0.082			64823		800	
	0.091			64913		650	
	0.10			64104		650	
	PITCH = 15.0 mm ± 0.4 mm; d _t = 0.80 mm ± 0.08 mm; U _{RAC} = 220 V; U _{p-p} = 620 V						
	0.11	7.0 x 13.5 x 17.5	1.8	64114	1000	650	
	PITCH = 22.5 mm ± 0.4 mm; d _t = 0.80 mm ± 0.08 mm; U _{RAC} = 220 V; U _{p-p} = 620 V						
0.12	6.0 x 15.5 x 26.0	2.4	64124	200	550		
0.13			64134				
0.15			64154				
0.16			64164				
0.18	64184	450					
0.20	7.0 x 16.5 x 26.0	2.9	64204	200	450		
0.22			64224		350		
0.24			64244		350		
0.27	8.5 x 18.0 x 26.0	3.8	64274	200	350		
0.30			64304				
PITCH = 27.5 mm ± 0.4 mm; d _t = 0.80 mm ± 0.08 mm; U _{RAC} = 220 V; U _{p-p} = 620 V							
0.33	9.0 x 19.0 x 31.5	5.5	64334	100	100		
0.36			64364				
0.39			64394				
0.43			64434				
0.47			64474				
0.51			64514				
0.56	11.0 x 21.0 x 31.0	7.4	64564	100	100		
0.62			64624				
0.68			64684				
0.75			64754				
0.82	13.0 x 23.0 x 31.0	9.2	64824	100	100		
0.91			64914				
1.0			64105				

Notes

- SPQ = Standard Packing Quantity
- U_{RAC} = 250 V / U_{p-p} = 700 V for C > 0.11 μF.
- (1) l_t = 4.0 mm + 1 mm / - 0.5 mm for pitch = 10 mm and 3.5 mm ± 0.3 mm for pitch = 15 mm; 22.5 mm and 27.5 mm.
- (2) H = in-tape height; P₀ = sprocket hole distance; for detailed specifications refer to packaging information: www.vishay.com/doc?28139
- (3) Weight for short lead product only



CAPACITANCE

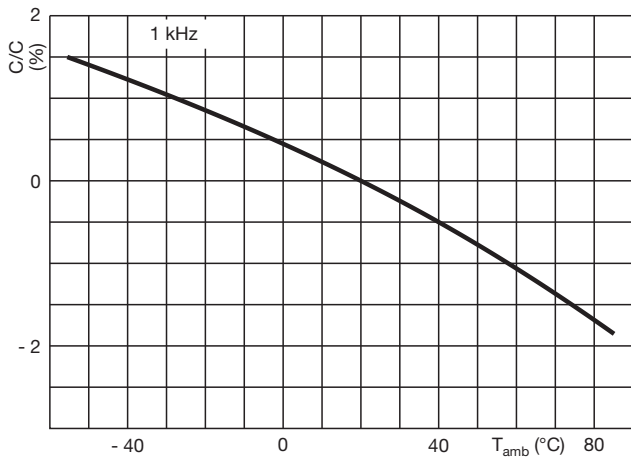

IMPEDANCE

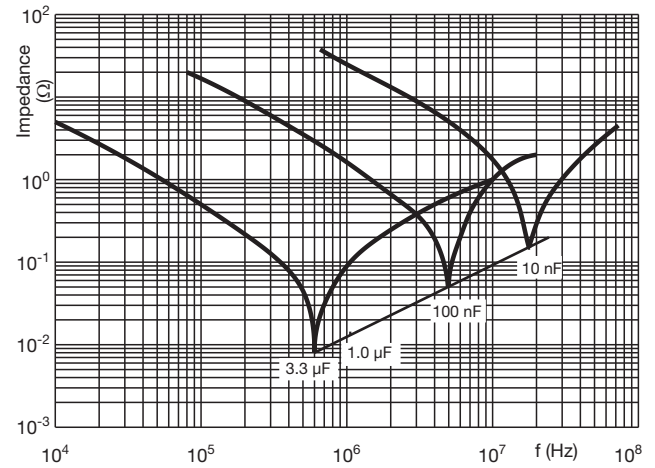

MAXIMUM RMS VOLTAGE (SINEWAVE) AS A FUNCTION OF FREQUENCY

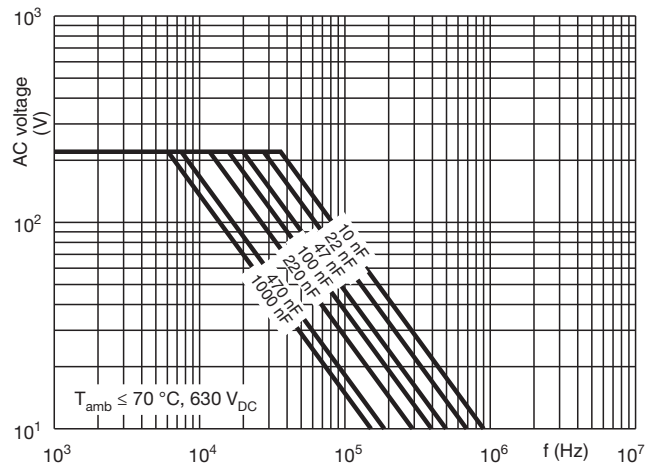
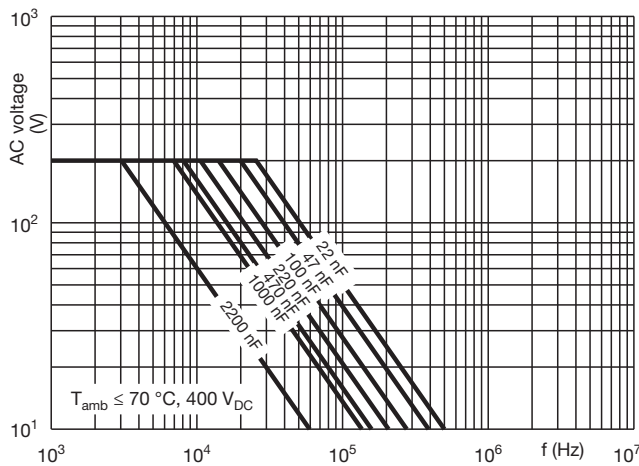
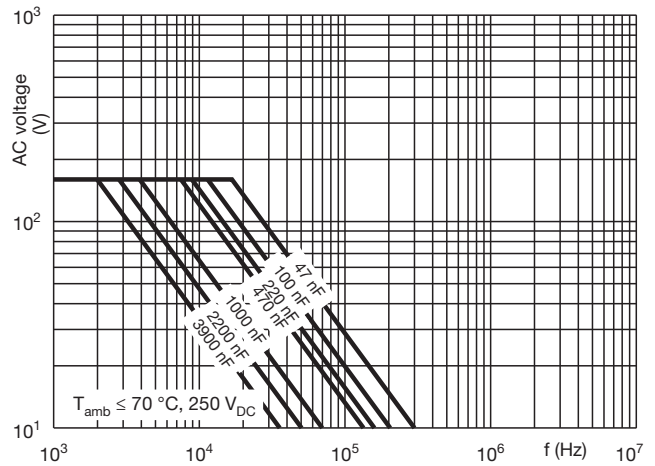
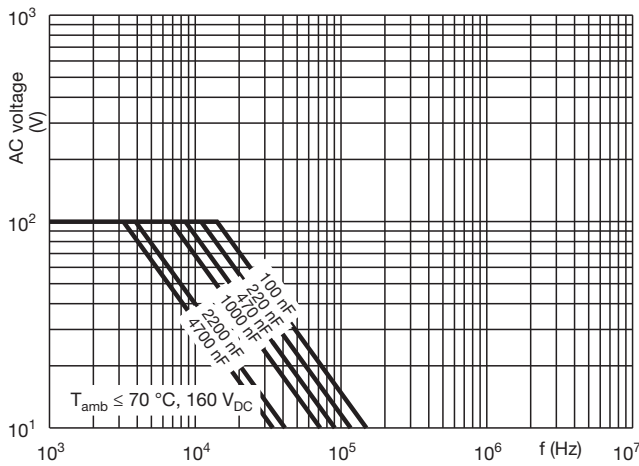



Disclaimer

ALL PRODUCT, PRODUCT SPECIFICATIONS AND DATA ARE SUBJECT TO CHANGE WITHOUT NOTICE TO IMPROVE RELIABILITY, FUNCTION OR DESIGN OR OTHERWISE.

Vishay Intertechnology, Inc., its affiliates, agents, and employees, and all persons acting on its or their behalf (collectively, "Vishay"), disclaim any and all liability for any errors, inaccuracies or incompleteness contained in any datasheet or in any other disclosure relating to any product.

Vishay makes no warranty, representation or guarantee regarding the suitability of the products for any particular purpose or the continuing production of any product. To the maximum extent permitted by applicable law, Vishay disclaims (i) any and all liability arising out of the application or use of any product, (ii) any and all liability, including without limitation special, consequential or incidental damages, and (iii) any and all implied warranties, including warranties of fitness for particular purpose, non-infringement and merchantability.

Statements regarding the suitability of products for certain types of applications are based on Vishay's knowledge of typical requirements that are often placed on Vishay products in generic applications. Such statements are not binding statements about the suitability of products for a particular application. It is the customer's responsibility to validate that a particular product with the properties described in the product specification is suitable for use in a particular application. Parameters provided in datasheets and / or specifications may vary in different applications and performance may vary over time. All operating parameters, including typical parameters, must be validated for each customer application by the customer's technical experts. Product specifications do not expand or otherwise modify Vishay's terms and conditions of purchase, including but not limited to the warranty expressed therein.

Except as expressly indicated in writing, Vishay products are not designed for use in medical, life-saving, or life-sustaining applications or for any other application in which the failure of the Vishay product could result in personal injury or death. Customers using or selling Vishay products not expressly indicated for use in such applications do so at their own risk. Please contact authorized Vishay personnel to obtain written terms and conditions regarding products designed for such applications.

No license, express or implied, by estoppel or otherwise, to any intellectual property rights is granted by this document or by any conduct of Vishay. Product names and markings noted herein may be trademarks of their respective owners.

Looking for pricing, stock, or lifecycle information?

Click below to explore more details on WIN SOURCE:

 [View BFC237954244](#) on WIN SOURCE

 [Vishay](#) Information

Optimize Your Supply Chain with WIN SOURCE Solutions

-  Global Sourcing Solution
-  Obsolete Management
-  Cost Control Management
-  Shortage Management
-  Alternative Solution
-  Excess Inventory Management