



**THE DATASHEET OF
Q4010LH5**



Qxx10xx & Qxx10xHx Series

10 Amp Standard & Alternistor (High Commutation) Triacs

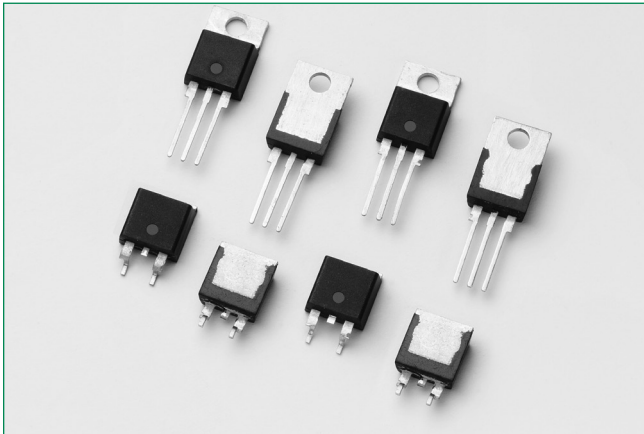

Description

The Qxx10xx and Qxx10xHx Series are 10 Amp bi-directional solid state switches. They are designed for AC switching and phase control applications such as motor speed and temperature modulation controls, lighting controls, and static switching relays. Standard type devices normally operate in Quadrants I & III triggered from AC line.

Features & Benefits

- RoHS-compliant
- Glass – passivated junctions
- Voltage capability up to 1000 V
- Surge capability up to 120 A
- 2500Vrms min. isolation between mounting tab and active terminals
- Solid-state switching eliminates arcing or contact bounce that create voltage transients
- No contacts to wear out from reaction of switching events
- Restricted (or limited) RFI generation, depending on activation point sine wave
- UL Recognized to UL 1557 as an Electrically Isolated Semiconductor Device

Additional Information



Resources



Accessories



Samples

Agency Approval

Agency	Agency File Number
	E71639*

* - L Package Only

Applications

Alternistor type devices are used in applications requiring high commutation performance such as controlling inductive loads. Isolated packages are offered with internal construction, having the case or mounting tab electrically isolated from the semiconductor chip.

Main Features

Symbol	Value	Unit
$I_{T(RMS)}$	10	A
V_{DRM}/V_{RRM}	400 to 1000	V
$I_{GT(Q1)}$	5 to 50	mA

Schematic Symbol

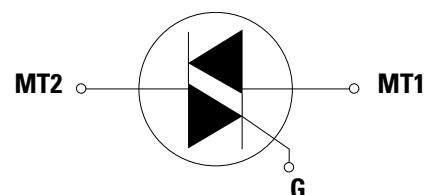

Qxx10xx & Qxx10xHx Series

10 Amp Standard & Alternistor (High Commutation) Triacs

Absolute Maximum Ratings – Standard Triac

Symbol	Parameter	Value	Unit	
$I_{T(RMS)}$	RMS on-state current (full sine wave)	Qxx10Ry/Qxx10Ny $T_C = 95^\circ\text{C}$	10	A
		Qxx10Ly $T_C = 90^\circ\text{C}$		
I_{TSM}	Non repetitive surge peak on-state current (full cycle, T_J initial = 25°C)	f = 50 Hz t = 20 ms	100	A
		f = 60 Hz t = 16.7 ms	120	
I^2t	I^2t Value for fusing	$t_p = 8.3$ ms	60	A^2s
di/dt	Critical rate of rise of on-state current $I_G = 200\text{mA}$ with $\leq 0.1\mu\text{s}$ rise time	f = 120 Hz $T_J = 125^\circ\text{C}$	70	$\text{A}/\mu\text{s}$
I_{GTM}	Peak gate trigger current	$t_p \leq 10\mu\text{s}$ $I_{GT} \leq I_{GTM}$ $T_J = 125^\circ\text{C}$	1.8	A
$P_{G(AV)}$	Average gate power dissipation	$T_J = 125^\circ\text{C}$	0.5	W
T_{stg}	Storage temperature range		-40 to 150	$^\circ\text{C}$
T_J	Operating junction temperature range		-40 to 125	$^\circ\text{C}$

Absolute Maximum Ratings – Alternistor Triac (3 Quadrants)

Symbol	Parameter	Value	Unit	
$I_{T(RMS)}$	RMS on-state current (full sine wave)	Qxx10LHy $T_C = 90^\circ\text{C}$	10	A
		Qxx10RHx/Qxx10NHx $T_C = 95^\circ\text{C}$		
I_{TSM}	Non repetitive surge peak on-state current (full cycle, T_J initial = 25°C)	f = 50 Hz t = 20 ms	110	A
		f = 60 Hz t = 16.7 ms	120	
I^2t	I^2t Value for fusing	$t_p = 8.3$ ms	60	A^2s
di/dt	Critical rate of rise of on-state current	f = 120 Hz $T_J = 125^\circ\text{C}$	70	$\text{A}/\mu\text{s}$
I_{GTM}	Peak gate trigger current	$t_p \leq 10\mu\text{s}$ $I_{GT} \leq I_{GTM}$ $T_J = 125^\circ\text{C}$	2.0	A
$P_{G(AV)}$	Average gate power dissipation	$T_J = 125^\circ\text{C}$	0.5	W
T_{stg}	Storage temperature range	-	-40 to 150	$^\circ\text{C}$
T_J	Operating junction temperature range	-	-40 to 125	$^\circ\text{C}$

Electrical Characteristics ($T_J = 25^\circ\text{C}$, unless otherwise specified) – Standard Triac

Symbol	Test Conditions	Quadrant	Qxx10x4	Qxx10x5	Unit
I_{GT}	$V_D = 12\text{V}$ $R_L = 60\Omega$	I – II – III	25	50	mA
		IV	50	75 (TYP)	
V_{GT}	$V_D = 12\text{V}$ $R_L = 60\Omega$	I – II – III	1.3		V
V_{GD}	$V_D = V_{DRM}$ $R_L = 3.3\text{k}\Omega$ $T_J = 125^\circ\text{C}$	ALL	0.2		V
I_H	$I_T = 200\text{mA}$		35	50	mA
dv/dt	$V_D = V_{DRM}$ Gate Open $T_J = 125^\circ\text{C}$	400V	150	225	$\text{V}/\mu\text{s}$
		600V	100	200	
		800V	75	175	
	$V_D = V_{DRM}$ Gate Open $T_J = 100^\circ\text{C}$	1000V	50	150	
(dv/dt)c	(di/dt)c = 5.4 A/ms $T_J = 125^\circ\text{C}$		2	4	$\text{V}/\mu\text{s}$
t_{gt}	$I_G = 2 \times I_{GT}$ PW = 15 μs $I_T = 14.1$ A(pk)		3.0	3.0	μs

Note: xx = voltage, x = package, y = sensitivity

Qxx10xx & Qxx10xHx Series

10 Amp Standard & Alternistor (High Commutation) Triacs

Electrical Characteristics ($T_J = 25^\circ\text{C}$, unless otherwise specified) — Alternistor Triac (3 Quadrants)

Symbol	Test Conditions	Quadrant		Value		Unit	
				Qxx10xH2	Qxx10xH5		
I_{GT}	$V_D = 12\text{V}, R_L = 60\Omega$	I-II-III	MAX	5	50	m A	
V_{GT}			MAX	1.3	1.3	V	
V_{GD}			MIN	0.2	0.2	V	
I_H	$V_D = V_{DRM}, R_L = 3.3\text{k}\Omega, T_J = 125^\circ\text{C}$		MAX	10	50	m A	
dv/dt	$V_D = V_{DRM}, \text{Gate Open}, T_J = 125^\circ\text{C}$	400V	MIN.	-	750	V/us	
				600V	-		650
				800V	-		500
				1000V	-		300
				800V	150		-
$(dv/dt)/c$	$(di/dt)/c = 5.4 \text{ A/ms}, T_J = 125^\circ\text{C}$		TYP.	3.5	30	V/us	
tgt	$IG = 2 \times I_{GT}, PW = 15\mu\text{s}, I_T = 14.1\text{A(pk)}$		TYP.	3	4	μs	

Static Characteristics

Symbol	Test Conditions		Value	Unit
V_{TM}	$I_{TM} = 14.1\text{A}$	$t_p = 380 \mu\text{s}$	MAX.	1.60
I_{DRM} I_{RRM}	$V_{DRM} = V_{RRM}$	$T_J = 25^\circ\text{C}$	400 - 600V	10
		$T_J = 125^\circ\text{C}$	400 - 800V	2
		$T_J = 100^\circ\text{C}$	1000V	3

Thermal Resistances

Symbol	Parameter		Value	Unit
$R_{\theta(J-C)}$	Junction to case (AC)	Qxx10Ryy/Qxx10Nyy	1.3	$^\circ\text{C/W}$
		Qxx10Lyy	2.6	
$R_{\theta(J-A)}$	Junction to ambient (AC)	Qxx10Ryy	45	$^\circ\text{C/W}$
		Qxx10Lyy	50	

Note: xx = voltage, x = package, y = sensitivity, yy = type & sensitivity

Qxx10xx & Qxx10xHx Series

10 Amp Standard & Alternistor (High Commutation) Triacs

Figure 1:
Definition of Quadrants

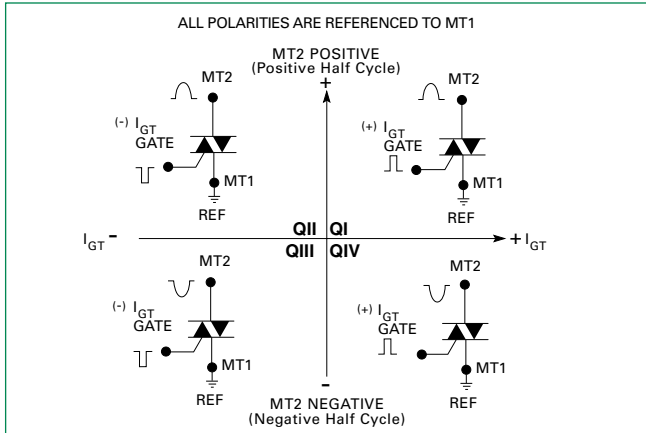

Figure 2:
Normalized DC Gate Trigger Current for All Quadrants vs. Junction Temperature

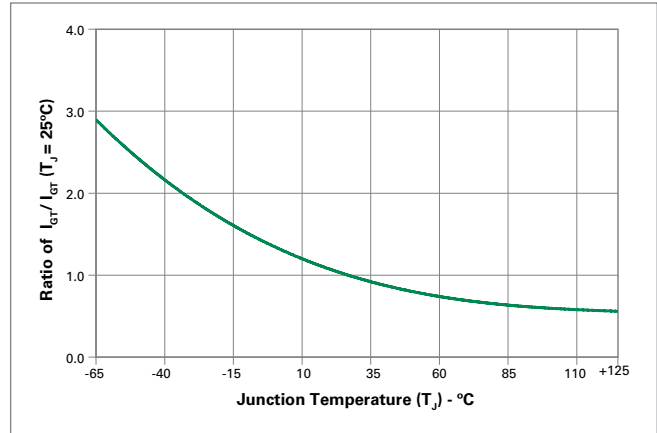

Figure 3:
Normalized DC Holding Current vs. Junction Temperature

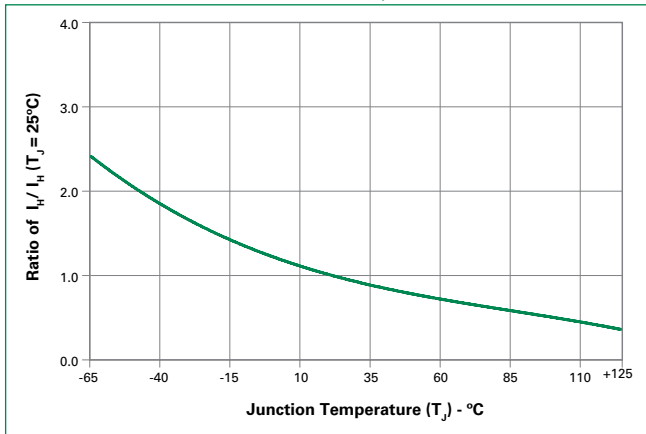

Figure 4:
Normalized DC Gate Trigger Voltage for All Quadrants vs. Junction Temperature

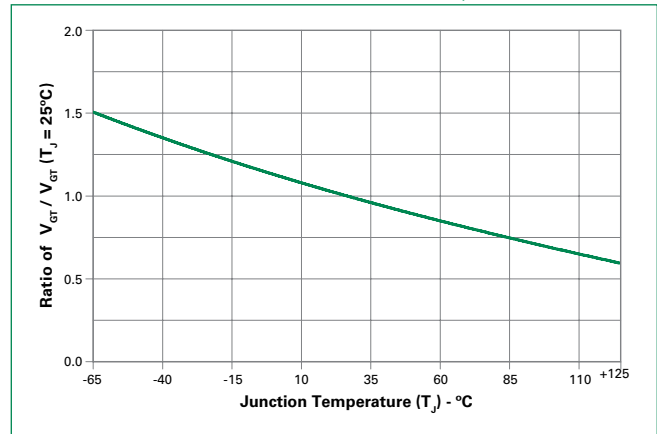

Figure 5:
Power Dissipation (Typical) vs. RMS On-State Current

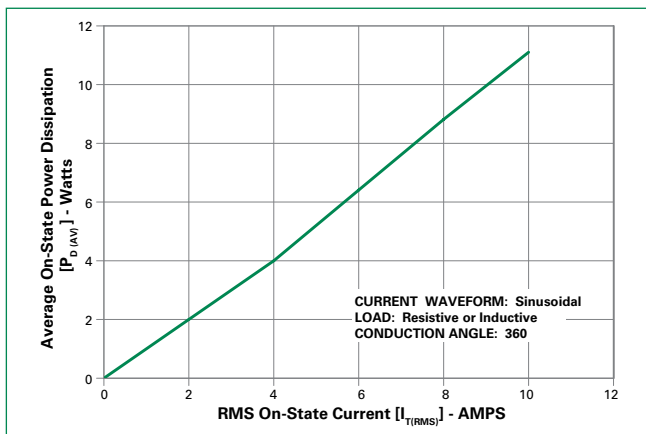
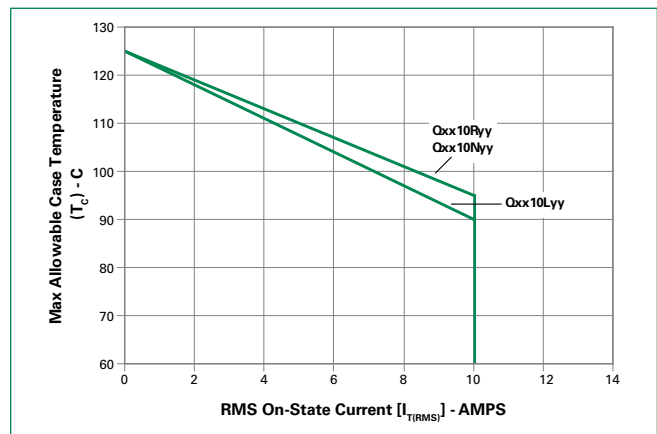

Figure 6:
Maximum Allowable Case Temperature vs. On-State Current



Qxx10xx & Qxx10xHx Series

10 Amp Standard & Alternistor (High Commutation) Triacs

Figure 7:
Maximum Allowable Ambient Temperature vs. On-State Current

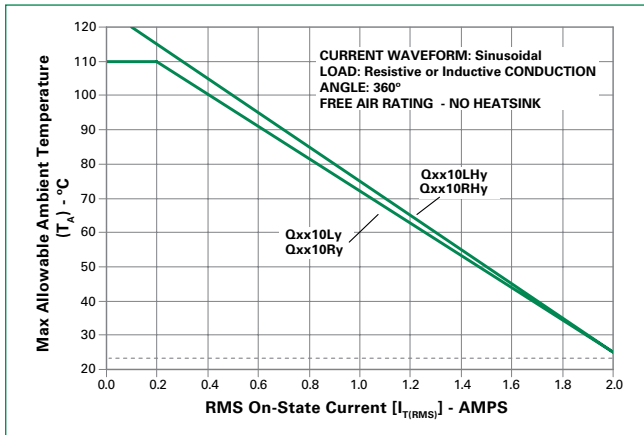

Figure 8:
On-State Current vs. On-State Voltage (Typical)

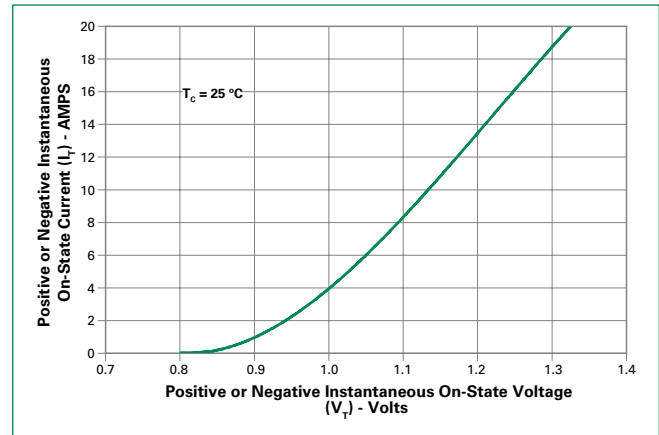
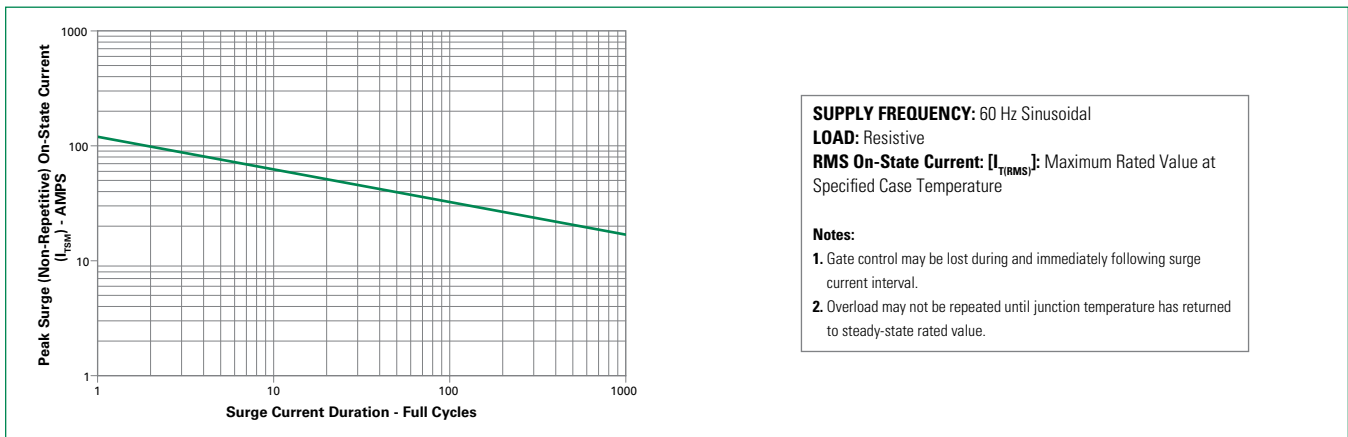

Figure 9:
Surge Peak On-State Current vs. Number of Cycles



Qxx10xx & Qxx10xHx Series

10 Amp Standard & Alternistor (High Commutation) Triacs

Soldering Parameters

Reflow Condition		Pb – Free assembly
Pre Heat	- Temperature Min ($T_{s(min)}$)	150°C
	- Temperature Max ($T_{s(max)}$)	200°C
	- Time (min to max) (t_s)	60 – 180 secs
Average ramp up rate (Liquidus Temp) (T_L) to peak		5°C/second max
$T_{s(max)}$ to T_L - Ramp-up Rate		5°C/second max
Reflow	- Temperature (T_L) (Liquidus)	217°C
	- Time (min to max) (t_s)	60 – 150 seconds
Peak Temperature (T_p)		260 ^{+0/-5} °C
Time within 5°C of actual peak Temperature (t_p)		20 – 40 seconds
Ramp-down Rate		5°C/second max
Time 25°C to peak Temperature (T_p)		8 minutes Max.
Do not exceed		280°C

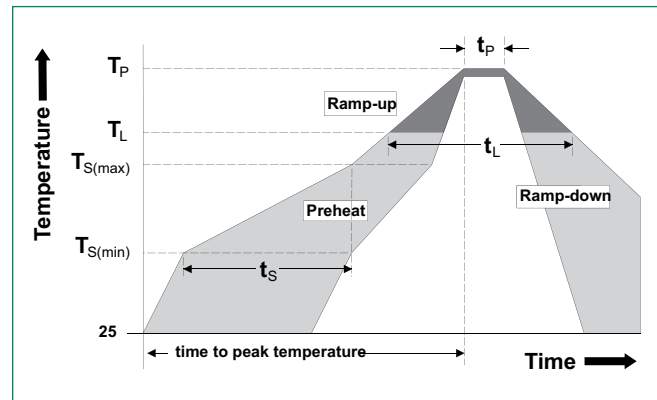

Physical Specifications

Terminal Finish	100% Matte Tin-plated
Body Material	UL recognized epoxy meeting flammability classification 94V-0.
Terminal Material	Copper Alloy

Design Considerations

Careful selection of the correct device for the application's operating parameters and environment will go a long way toward extending the operating life of the Thyristor. Good design practice should limit the maximum continuous current through the main terminals to 75% of the device rating. Other ways to ensure long life for a power discrete semiconductor are proper heat sinking and selection of voltage ratings for worst case conditions. Overheating, overvoltage (including dv/dt), and surge currents are the main killers of semiconductors. Correct mounting, soldering, and forming of the leads also help protect against component damage.

Environmental Specifications

Test	Specifications and Conditions
AC Blocking	MIL-STD-750, M-1040, Cond A Applied Peak AC voltage @ 125°C for 1008 hours
Temperature Cycling	MIL-STD-750, M-1051, 100 cycles; -40°C to +150°C, 15-min dwell-time
Temperature/Humidity	EIA/JEDEC, JESD22-A101 1008 hours; 320V - DC: 85°C; 85% rel humidity
High Temp Storage	MIL-STD-750, M-1031, 1008 hours; 150°C
Low-Temp Storage	1008 hours; -40°C
Resistance to Solder Heat	MIL-STD-750 Method 2031
Solderability	ANSI/J-STD-002, category 3 Test A
Lead Bend	MIL-STD-750, M-2036 Cond E

Qxx10xx & Qxx10xHx Series

10 Amp Standard & Alternistor (High Commutation) Triacs

Dimensions - TO-220AB (R-Package) - Non-Isolated Mounting Tab Common with Center Lead

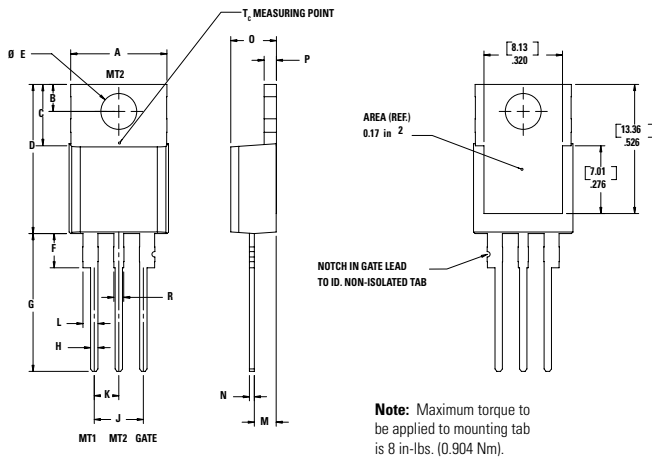

Dimension	Inches		Millimeters	
	Min	Max	Min	Max
A	0.380	0.420	9.65	10.67
B	0.105	0.115	2.67	2.92
C	0.230	0.250	5.84	6.35
D	0.590	0.620	14.99	15.75
E	0.142	0.147	3.61	3.73
F	0.110	0.130	2.79	3.30
G	0.540	0.575	13.72	14.61
H	0.025	0.035	0.64	0.89
J	0.195	0.205	4.95	5.21
K	0.095	0.105	2.41	2.67
L	0.060	0.075	1.52	1.91
M	0.085	0.095	2.16	2.41
N	0.018	0.024	0.46	0.61
O	0.178	0.188	4.52	4.78
P	0.045	0.060	1.14	1.52
R	0.038	0.048	0.965	1.22

Dimensions - TO-220AB (L-Package) - Isolated Mounting Tab

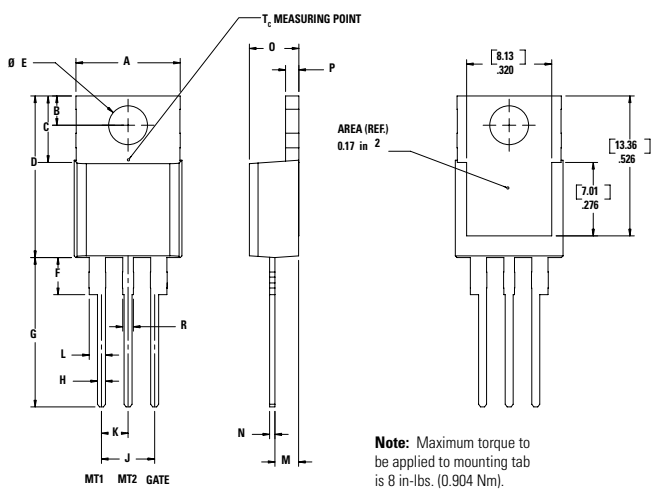

Dimension	Inches		Millimeters	
	Min	Max	Min	Max
A	0.380	0.420	9.65	10.67
B	0.105	0.115	2.67	2.92
C	0.230	0.250	5.84	6.35
D	0.590	0.620	14.99	15.75
E	0.142	0.147	3.61	3.73
F	0.110	0.130	2.79	3.30
G	0.540	0.575	13.72	14.61
H	0.025	0.035	0.64	0.89
J	0.195	0.205	4.95	5.21
K	0.095	0.105	2.41	2.67
L	0.060	0.075	1.52	1.91
M	0.085	0.095	2.16	2.41
N	0.018	0.024	0.46	0.61
O	0.178	0.188	4.52	4.78
P	0.045	0.060	1.14	1.52
R	0.038	0.048	0.965	1.22

Qxx10xx & Qxx10xHx Series

10 Amp Standard & Alternistor (High Commutation) Triacs

Dimensions - TO-263AB (N-Package) - D2-PAK Surface Mount

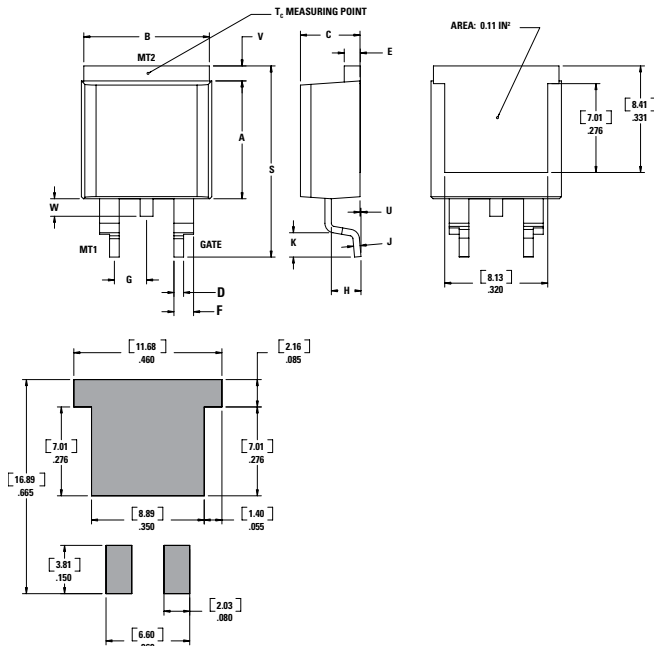

Dimension	Inches		Millimeters	
	Min	Max	Min	Max
A	0.360	0.370	9.14	9.40
B	0.380	0.420	9.65	10.67
C	0.178	0.188	4.52	4.78
D	0.025	0.035	0.64	0.89
E	0.045	0.060	1.14	1.52
F	0.060	0.075	1.52	1.91
G	0.095	0.105	2.41	2.67
H	0.092	0.102	2.34	2.59
J	0.018	0.024	0.46	0.61
K	0.090	0.110	2.29	2.79
S	0.590	0.625	14.99	15.88
V	0.035	0.045	0.89	1.14
U	0.002	0.010	0.05	0.25
W	0.040	0.070	1.016	1.78

Product Selector

Part Number	Voltage (xx)				Gate Sensitivity Quadrants		Type	Package
	400V	600V	800V	1000V	I – II – III	IV		
Qxx10LH2	-	-	X	-	5 mA	-	Alternistor Triac	TO-220L
Qxx10RH2	-	-	X	-	5 mA	-	Alternistor Triac	TO-220R
Qxx10NH2	-	-	X	-	5 mA	-	Alternistor Triac	TO-263 D2-PAK
Qxx10L4	X	X	X	X	25 mA	50 mA	Standard Triac	TO-220L
Qxx10R4	X	X	X	X	25 mA	50 mA	Standard Triac	TO-220R
Qxx10N4	X	X	X	X	25 mA	50 mA	Standard Triac	TO-263 D2-PAK
Qxx10L5	X	X	X	X	50 mA	-	Standard Triac	TO-220L
Qxx10R5	X	X	X	X	50 mA	TYP. 75 mA	Standard Triac	TO-220R
Qxx10N5	X	X	X	X	50 mA	TYP. 75 mA	Standard Triac	TO-263 D2-PAK
Qxx10LH5	X	X	X	X	50 mA	TYP. 75 mA	Alternistor Triac	TO-220L
Qxx10RH5	X	X	X	X	50 mA	-	Alternistor Triac	TO-220R
Qxx10NH5	X	X	X	X	50 mA	-	Alternistor Triac	TO-263 D2-PAK

Packing Options

Part Number	Marking	Weight	Packing Mode	Base Quantity
Qxx10L/RyyTP	Qxx10L/Ryy	2.2 g	Tube Pack	1000 (50 per tube)
Qxx10NyyTP	Qxx10Nyy	1.6 g	Tube	1000 (50 per tube)
Qxx10NyyRP	Qxx10Nyy	1.6 g	Embossed Carrier	500

Note: xx = voltage, yy = type & sensitivity

Qxx10xx & Qxx10xHx Series

10 Amp Standard & Alternistor (High Commutation) Triacs

TO-263 Embossed Carrier Reel Pack (RP) Specifications

Meets all EIA-481-2 Standards

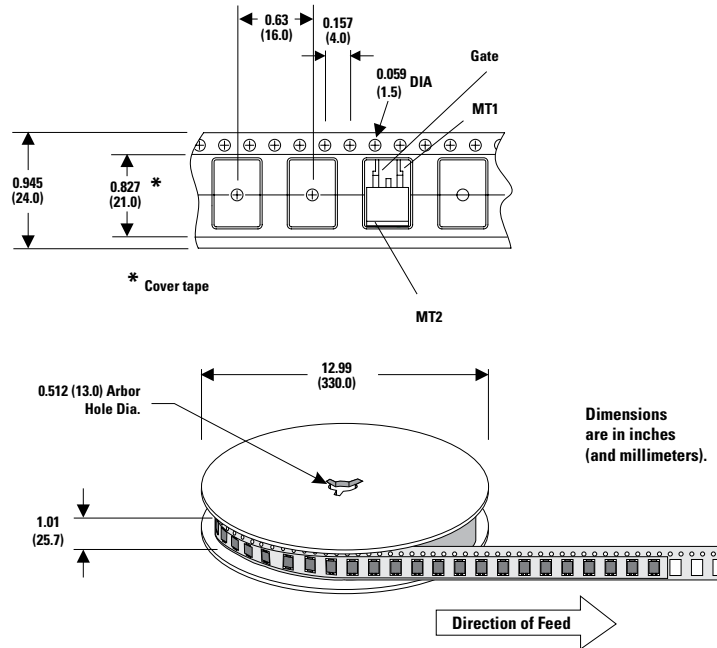

Dimensions are in inches (and millimeters).

Part Numbering System

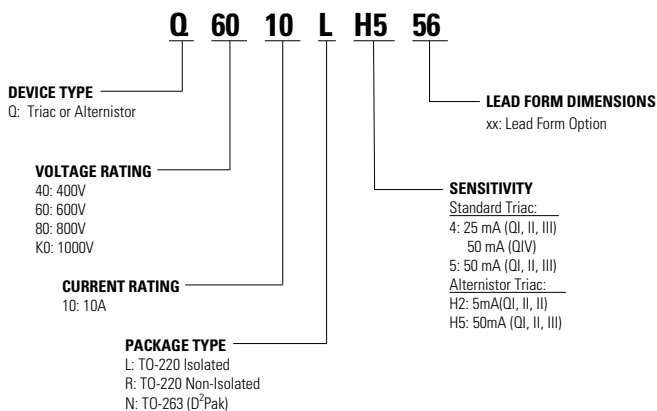

Part Marking System

TO-220 AB - (L and R Package)
TO-263 AB - (N Package)

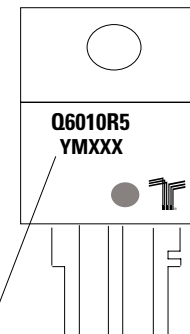

Date Code Marking
Y: Year Code
M: Month Code
XXX: Lot Trace Code

Disclaimer Notice - Information furnished is believed to be accurate and reliable. However, users should independently evaluate the suitability of and test each product selected for their own applications. Littelfuse products are not designed for, and may not be used in, all applications. Read complete Disclaimer Notice at www.littelfuse.com/disclaimer-electronics.

Looking for pricing, stock, or lifecycle information?

Click below to explore more details on WIN SOURCE:

 [View Q4010LH5 on WIN SOURCE](#)

 [Littelfuse Inc. Information](#)

Optimize Your Supply Chain with WIN SOURCE Solutions

-  Global Sourcing Solution
-  Obsolete Management
-  Cost Control Management
-  Shortage Management
-  Alternative Solution
-  Excess Inventory Management