



**THE DATASHEET OF
PT6901C**



- +5V/+3.3V Input Voltage
- Negative Output
- Remote Sense
- Adjustable Output Voltage
- 23-pin SIP Package

The PT6900 is a series of high-performance ISRs, that provide plus to minus voltage conversion, up to 12 watt in a 23-pin SIP package.

The PT6900 is designed to supply regulated negative voltages for powering the latest ECL (-5.2V) and GaAs (-2.0V) ICs used in high-speed fiber optic communications. A 330µF electrolytic capacitor is required on the input and output for proper operation.

Please note that this product is not short-circuit protected.

Standard Application

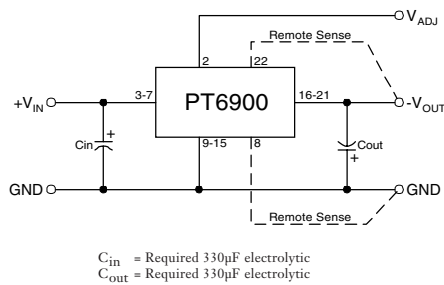

Pin-Out Information

Pin	Function	Pin	Function
1	Do not connect	13	GND
2	V_{out} Adjust	14	GND
3	V_{in}	15	GND
4	V_{in}	16	V_{out}
5	V_{in}	17	V_{out}
6	V_{in}	18	V_{out}
7	V_{in}	19	V_{out}
8	Remote Sense GND	20	V_{out}
9	GND	21	V_{out}
10	GND	22	Remote Sense V_{out}
11	GND	23	Do not connect
12	GND		

Ordering Information

+5V Input	+3.3V Input	V_{out}
PT6901□	PT6904□	= -2.0V
PT6902□	PT6905□	= -5.2V
PT6903□		= -1.5V

PT Series Suffix (PT1234X)

Case/Pin Configuration

Vertical Through-Hole	N
Horizontal Through-Hole	A
Horizontal Surface Mount	C

(For dimensions and PC board layout, see Package Styles 1100 and 1110.)

Specifications

Characteristics ($T_a = 25^\circ\text{C}$ unless noted)	Symbols	Conditions	PT6900 SERIES			Units	
			Min	Typ	Max		
Output Current	I_o	$T_a = +25^\circ\text{C}$, natural convection $V_{in} = 5.0\text{V}$	$V_o = -2.0\text{V} / -1.5\text{V}$	0.1 (1)	—	6.0 (2)	A
			$V_o = -5.2\text{V}$	0.1 (1)	—	3.5 (2)	
			$V_{in} = 3.3\text{V}$	$V_o = -2.0\text{V}$	0.1 (1)	—	5.0 (2)
	$V_o = -5.2\text{V}$	0.1 (1)	—	2.5 (2)			
Input Voltage Range		$0.1\text{A} \leq I_o \leq I_{max}$ PT6901 PT6902/PT6903 PT6904/PT6905	4.5 3.1	—	5.5 3.6	V	
Output Voltage Tolerance	ΔV_o	Nominal V_{in} , $I_o = I_{max}$ $0^\circ\text{C} \leq T_a \leq +60^\circ\text{C}$	$V_o - 0.05$	—	$V_o + 0.05$	V	
Output Adjust Range	V_o	Pin 14 to V_o or GND $V_o = -2.0\text{V}$ $V_o = -5.2\text{V}$ $V_o = -1.5\text{V}$	-1.4 -2.7 -1.2	—	-4.4 -6.5 -3.4	V	
Line Regulation	Reg_{line}	Over V_{in} range, $I_o = I_{max}$	—	± 0.5	± 1.0	%	
Load Regulation	Reg_{load}	$V_{in} = V_{nom}$, $0.1 \leq I_o \leq I_{max}$	—	± 0.5	± 1.0	%	
V_o Ripple/Noise	V_n	$V_{in} = V_{nom}$, $I_o = I_{max}$ $V_o = -1.5\text{V} / -2.0\text{V}$ $V_o = -5.2\text{V}$	—	40 50	—	mV	
Transient Response with $C_{out} = 330\mu\text{F}$	t_{tr} V_{os}	I_o step between $0.5xI_{max}$ and I_{max} V_o over/undershoot	—	200	—	μSec	
			—	200	—	mV	
Efficiency	η	$V_{in} = +5\text{V}$, $I_o = 0.5xI_{max}$	$V_o = -1.5\text{V}$	—	65	—	%
			$V_o = -2.0\text{V}$	—	70	—	
			$V_o = -5.2\text{V}$	—	77	—	
		$V_{in} = +3.3\text{V}$, $I_o = 0.5xI_{max}$	$V_o = -2.0\text{V}$	—	67	—	%
$V_o = -5.2\text{V}$	—	75	—				
Switching Frequency	f_o	Over V_{in} and I_o ranges	500	—	600	kHz	
Absolute Maximum Operating Temperature Range	T_a	Over V_{in} Range	0	—	+85 (2)	$^\circ\text{C}$	
Storage Temperature	T_s		-40	—	+125	$^\circ\text{C}$	
Weight	—	Vertical/Horizontal	—	28/33	—	grams	

- Notes:** (1) ISR will operate down to no load with reduced specifications.
(2) See SOA curves or contact the factory for the appropriate derating.

12 Watt 5V/3.3V Input
Plus to Minus Voltage Converter

5.0V Input Voltage (See Note A)

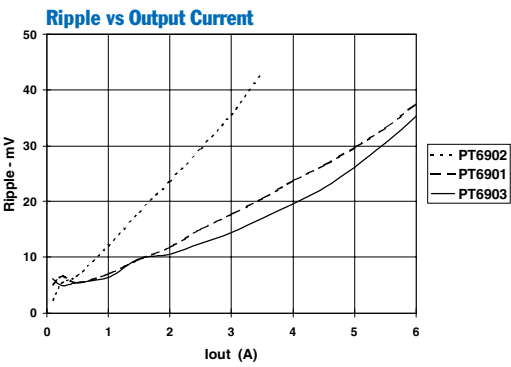
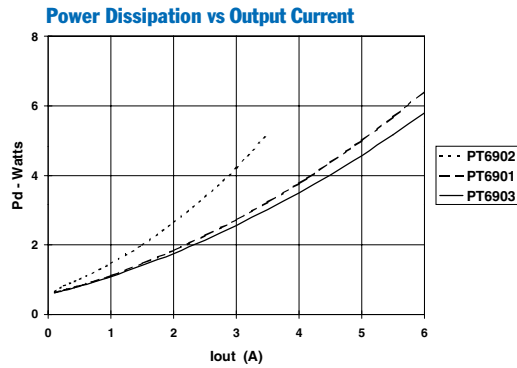
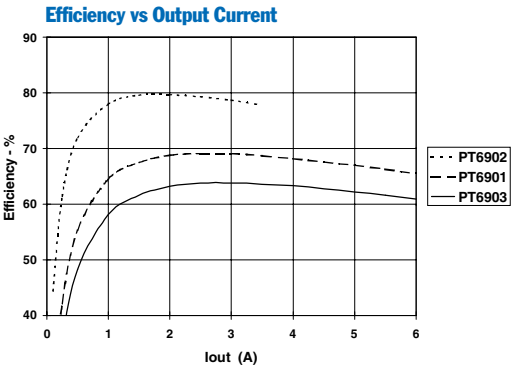

3.3V Input Voltage (See Note A)

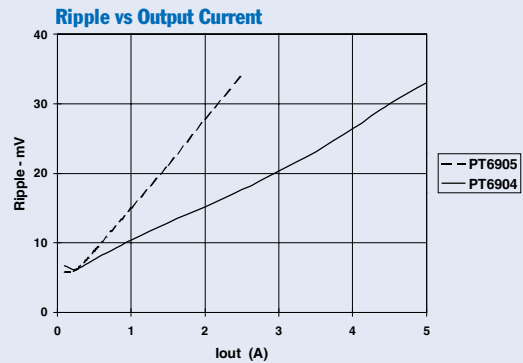
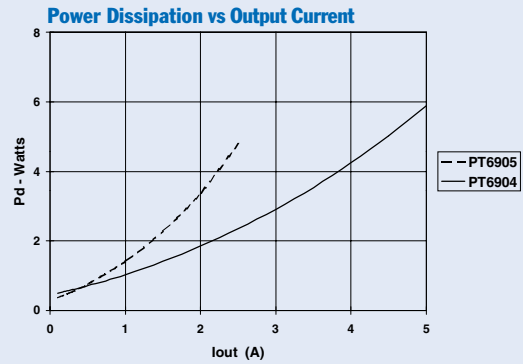
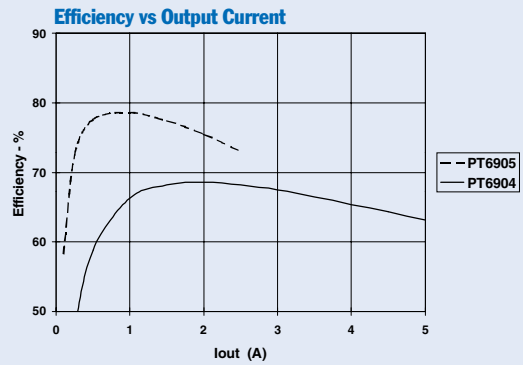

Safe Operating Area, PT6901 ($V_{in} = 5.0V$) (See Note B)

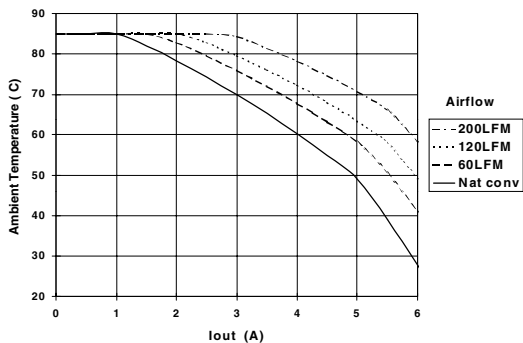

Safe Operating Area, PT6902 ($V_{in} = 5.0V$) (See Note B)

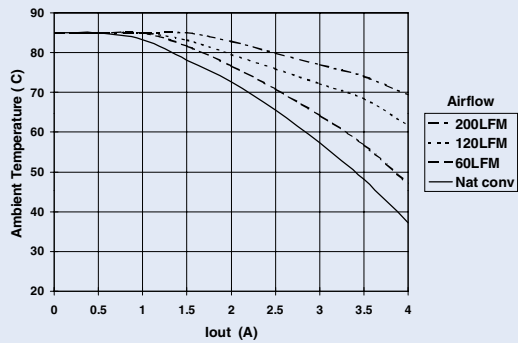

Note A: All data listed in the above graphs has been developed from actual products tested at 25°C. This data is considered typical data for the DC-DC Converter.

Note B: SOA curves represent operating conditions at which internal components are at or below manufacturer's maximum operating temperatures

Adjusting the Output Voltage of the PT6900/PT6910 Positive to Negative Converter Series

The negative output voltage of the Power Trends PT6900 Series ISRs may be adjusted higher or lower than the factory trimmed pre-set voltage with the addition of a single external resistor. Table 1 gives the allowable adjustment range for each model in the series as V_a (min) and V_a (max).

Adjust Up: An increase in the output voltage is obtained by adding a resistor R2, between pin 2 (V_o adjust) and pin 8 (Remote Sense GND).

Adjust Down: Add a resistor (R1), between pin 2 (V_o adjust) and pin 22 (Remote Sense V_o).

Refer to Figure 1 and Table 2 for both the placement and value of the required resistor, either (R1) or R2 as appropriate.

Notes:

1. Only a single 1% resistor is required in either the (R1) or R2 location. Do not use (R1) and R2 simultaneously. Place the resistor as close to the ISR as possible.
2. Never connect capacitors from V_o adjust to either GND, V_{out} , or the Sense pins. Any capacitance added to the V_o adjust pin will affect the stability of the ISR.
3. If the sense pins are not being used, the resistors (R1) and R2 can be connected to V_{out} and GND respectively.
4. An increase in the output voltage must be accompanied by a corresponding reduction in the maximum output current. The revised maximum output current must be reduced to the equivalent of 12Watts.

$$\text{i.e. } I_{out}(\text{max}) = \frac{12}{V_a} \text{ A dc,}$$

where V_a is the adjusted output voltage.

Figure 1

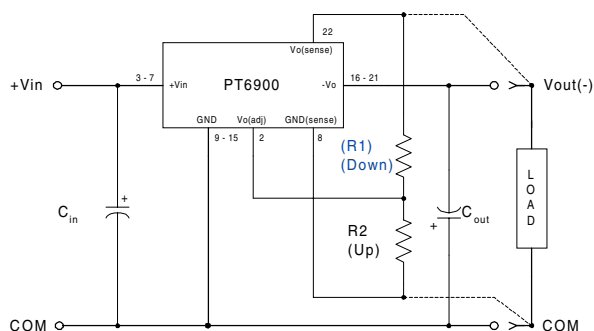

The respective values of (R1) [adjust down], and R2 [adjust up], can also be calculated using the following formulas.

$$(R1) = \frac{24.9 (V_a - V_r)}{(V_o - V_a)} - R_s \text{ k}\Omega$$

$$R2 = \frac{24.9 V_r}{(V_a - V_o)} - R_s \text{ k}\Omega$$

Where:

- V_o = Original output voltage
- V_a = Adjusted output voltage
- V_r = Reference voltage in Table 1
- R_s = The resistance given in Table 1

Table 1

PT6900/PT6910 ADJUSTMENT RANGE AND FORMULA PARAMETERS			
Series Pt #			
5.0V Bus	PT6903/13	PT6901/11	PT6902/12
3.3V Bus		PT6904/14	PT6905/15
V_o (nom)	-1.5V	-2.0V	-5.2V
V_a (min)	-1.2V	-1.4V	-2.7V
V_a (max)	-3.4V	-4.5V	-6.5V
V_r	-1.0V	-1.0V	-0.92V
R_s (k Ω)	12.7	10.0	17.4

PT6900/6910 Series

Table 2

PT6900/PT6910 ADJUSTMENT RESISTOR VALUES

Series Pt #				Series Pt #			
5.0V Bus	PT6903/13	PT6901/11	PT6902/12	5.0V Bus	PT6903/13	PT6901/11	PT6902/12
3.3V Bus		PT6904/14	PT6905/15	3.3V Bus		PT6904/14	PT6905/15
V _o (nom)	-1.5Vdc	-2.0Vdc	-5.2Vdc	V _o (nom)	-1.5Vdc	-2.0Vdc	-5.2Vdc
V _a (req'd)				V _a (req'd)			
-1.2	(3.9)kΩ			-3.9		3.1kΩ	(39.7)kΩ
-1.3	(24.7)kΩ			-4.0		2.5kΩ	(46.5)kΩ
-1.4	(86.9)kΩ	(6.6)kΩ		-4.1		1.9kΩ	(54.6)kΩ
-1.5		(14.9)kΩ		-4.2		1.3kΩ	(64.3)kΩ
-1.6	236.0kΩ	(27.4)kΩ		-4.3		0.8kΩ	(76.1)kΩ
-1.7	112.0kΩ	(48.1)kΩ		-4.4		0.4kΩ	(90.9)kΩ
-1.8	70.3kΩ	(89.6)kΩ		-4.5		0.0kΩ	(106.0)kΩ
-1.9	49.6kΩ	(214.0)kΩ		-4.6			(135.0)kΩ
-2.0	37.1kΩ			-4.7			(171.0)kΩ
-2.1	28.8kΩ	239.0kΩ		-4.8			(224.0)kΩ
-2.2	22.9kΩ	115.0kΩ		-4.9			(313.0)kΩ
-2.3	18.4kΩ	73.0kΩ		-5.0			(491.0)kΩ
-2.4	15.0kΩ	52.3kΩ		-5.1			(1020.0)kΩ
-2.5	12.2kΩ	39.8kΩ		-5.2			
-2.6	9.9kΩ	31.5kΩ		-5.3			212.0kΩ
-2.7	8.1kΩ	25.6kΩ	(0.3)kΩ	-5.4			97.1kΩ
-2.8	6.5kΩ	21.1kΩ	(2.1)kΩ	-5.5			59.0kΩ
-2.9	5.1kΩ	17.7kΩ	(4.0)kΩ	-5.6			39.9kΩ
-3.0	3.9kΩ	14.9kΩ	(6.1)kΩ	-5.7			28.4kΩ
-3.1	2.9kΩ	12.6kΩ	(8.5)kΩ	-5.8			20.8kΩ
-3.2	2.0kΩ	10.8kΩ	(11.0)kΩ	-5.9			15.3kΩ
-3.3	1.1kΩ	9.2kΩ	(13.8)kΩ	-6.0			11.2kΩ
-3.4	0.4kΩ	7.8kΩ	(16.9)kΩ	-6.1			8.1kΩ
-3.5		6.6kΩ	(20.4)kΩ	-6.2			5.5kΩ
-3.6		5.6kΩ	(24.3)kΩ	-6.3			3.4kΩ
-3.7		4.7kΩ	(28.7)kΩ	-6.4			1.7kΩ
-3.8		3.8kΩ	(33.8)kΩ	-6.5			0.2kΩ

R1 = (Blue)

R2 = Black

PACKAGING INFORMATION

Orderable Device	Status (1)	Package Type	Package Drawing	Pins	Package Qty	Eco Plan (2)	Lead/Ball Finish (6)	MSL Peak Temp (3)	Op Temp (°C)	Device Marking (4/5)	Samples
PT6903A	OBSOLETE	SIP MODULE	EJJ	23		TBD	Call TI	Call TI			
PT6903C	OBSOLETE	SIP MODULE	EJK	23		TBD	Call TI	Call TI			
PT6903N	OBSOLETE	SIP MODULE	EJH	23		TBD	Call TI	Call TI			
PT6904A	OBSOLETE	SIP MODULE	EJJ	23		TBD	Call TI	Call TI			
PT6904C	OBSOLETE	SIP MODULE	EJK	23		TBD	Call TI	Call TI			
PT6904N	OBSOLETE	SIP MODULE	EJH	23		TBD	Call TI	Call TI			

(1) The marketing status values are defined as follows:

ACTIVE: Product device recommended for new designs.

LIFEBUY: TI has announced that the device will be discontinued, and a lifetime-buy period is in effect.

NRND: Not recommended for new designs. Device is in production to support existing customers, but TI does not recommend using this part in a new design.

PREVIEW: Device has been announced but is not in production. Samples may or may not be available.

OBSOLETE: TI has discontinued the production of the device.

(2) Eco Plan - The planned eco-friendly classification: Pb-Free (RoHS), Pb-Free (RoHS Exempt), or Green (RoHS & no Sb/Br) - please check <http://www.ti.com/productcontent> for the latest availability information and additional product content details.

TBD: The Pb-Free/Green conversion plan has not been defined.

Pb-Free (RoHS): TI's terms "Lead-Free" or "Pb-Free" mean semiconductor products that are compatible with the current RoHS requirements for all 6 substances, including the requirement that lead not exceed 0.1% by weight in homogeneous materials. Where designed to be soldered at high temperatures, TI Pb-Free products are suitable for use in specified lead-free processes.

Pb-Free (RoHS Exempt): This component has a RoHS exemption for either 1) lead-based flip-chip solder bumps used between the die and package, or 2) lead-based die adhesive used between the die and leadframe. The component is otherwise considered Pb-Free (RoHS compatible) as defined above.

Green (RoHS & no Sb/Br): TI defines "Green" to mean Pb-Free (RoHS compatible), and free of Bromine (Br) and Antimony (Sb) based flame retardants (Br or Sb do not exceed 0.1% by weight in homogeneous material)

(3) MSL, Peak Temp. - The Moisture Sensitivity Level rating according to the JEDEC industry standard classifications, and peak solder temperature.

(4) There may be additional marking, which relates to the logo, the lot trace code information, or the environmental category on the device.

(5) Multiple Device Markings will be inside parentheses. Only one Device Marking contained in parentheses and separated by a "~" will appear on a device. If a line is indented then it is a continuation of the previous line and the two combined represent the entire Device Marking for that device.

(6) Lead/Ball Finish - Orderable Devices may have multiple material finish options. Finish options are separated by a vertical ruled line. Lead/Ball Finish values may wrap to two lines if the finish value exceeds the maximum column width.

Important Information and Disclaimer: The information provided on this page represents TI's knowledge and belief as of the date that it is provided. TI bases its knowledge and belief on information provided by third parties, and makes no representation or warranty as to the accuracy of such information. Efforts are underway to better integrate information from third parties. TI has taken and continues to take reasonable steps to provide representative and accurate information but may not have conducted destructive testing or chemical analysis on incoming materials and chemicals. TI and TI suppliers consider certain information to be proprietary, and thus CAS numbers and other limited information may not be available for release.

In no event shall TI's liability arising out of such information exceed the total purchase price of the TI part(s) at issue in this document sold by TI to Customer on an annual basis.

IMPORTANT NOTICE

Texas Instruments Incorporated and its subsidiaries (TI) reserve the right to make corrections, enhancements, improvements and other changes to its semiconductor products and services per JESD46, latest issue, and to discontinue any product or service per JESD48, latest issue. Buyers should obtain the latest relevant information before placing orders and should verify that such information is current and complete. All semiconductor products (also referred to herein as "components") are sold subject to TI's terms and conditions of sale supplied at the time of order acknowledgment.

TI warrants performance of its components to the specifications applicable at the time of sale, in accordance with the warranty in TI's terms and conditions of sale of semiconductor products. Testing and other quality control techniques are used to the extent TI deems necessary to support this warranty. Except where mandated by applicable law, testing of all parameters of each component is not necessarily performed.

TI assumes no liability for applications assistance or the design of Buyers' products. Buyers are responsible for their products and applications using TI components. To minimize the risks associated with Buyers' products and applications, Buyers should provide adequate design and operating safeguards.

TI does not warrant or represent that any license, either express or implied, is granted under any patent right, copyright, mask work right, or other intellectual property right relating to any combination, machine, or process in which TI components or services are used. Information published by TI regarding third-party products or services does not constitute a license to use such products or services or a warranty or endorsement thereof. Use of such information may require a license from a third party under the patents or other intellectual property of the third party, or a license from TI under the patents or other intellectual property of TI.

Reproduction of significant portions of TI information in TI data books or data sheets is permissible only if reproduction is without alteration and is accompanied by all associated warranties, conditions, limitations, and notices. TI is not responsible or liable for such altered documentation. Information of third parties may be subject to additional restrictions.

Resale of TI components or services with statements different from or beyond the parameters stated by TI for that component or service voids all express and any implied warranties for the associated TI component or service and is an unfair and deceptive business practice. TI is not responsible or liable for any such statements.

Buyer acknowledges and agrees that it is solely responsible for compliance with all legal, regulatory and safety-related requirements concerning its products, and any use of TI components in its applications, notwithstanding any applications-related information or support that may be provided by TI. Buyer represents and agrees that it has all the necessary expertise to create and implement safeguards which anticipate dangerous consequences of failures, monitor failures and their consequences, lessen the likelihood of failures that might cause harm and take appropriate remedial actions. Buyer will fully indemnify TI and its representatives against any damages arising out of the use of any TI components in safety-critical applications.

In some cases, TI components may be promoted specifically to facilitate safety-related applications. With such components, TI's goal is to help enable customers to design and create their own end-product solutions that meet applicable functional safety standards and requirements. Nonetheless, such components are subject to these terms.

No TI components are authorized for use in FDA Class III (or similar life-critical medical equipment) unless authorized officers of the parties have executed a special agreement specifically governing such use.

Only those TI components which TI has specifically designated as military grade or "enhanced plastic" are designed and intended for use in military/aerospace applications or environments. Buyer acknowledges and agrees that any military or aerospace use of TI components which have **not** been so designated is solely at the Buyer's risk, and that Buyer is solely responsible for compliance with all legal and regulatory requirements in connection with such use.

TI has specifically designated certain components as meeting ISO/TS16949 requirements, mainly for automotive use. In any case of use of non-designated products, TI will not be responsible for any failure to meet ISO/TS16949.

Products

Audio	www.ti.com/audio
Amplifiers	amplifier.ti.com
Data Converters	dataconverter.ti.com
DLP® Products	www.dlp.com
DSP	dsp.ti.com
Clocks and Timers	www.ti.com/clocks
Interface	interface.ti.com
Logic	logic.ti.com
Power Mgmt	power.ti.com
Microcontrollers	microcontroller.ti.com
RFID	www.ti-rfid.com
OMAP Applications Processors	www.ti.com/omap
Wireless Connectivity	www.ti.com/wirelessconnectivity

Applications

Automotive and Transportation	www.ti.com/automotive
Communications and Telecom	www.ti.com/communications
Computers and Peripherals	www.ti.com/computers
Consumer Electronics	www.ti.com/consumer-apps
Energy and Lighting	www.ti.com/energy
Industrial	www.ti.com/industrial
Medical	www.ti.com/medical
Security	www.ti.com/security
Space, Avionics and Defense	www.ti.com/space-avionics-defense
Video and Imaging	www.ti.com/video

TI E2E Community

e2e.ti.com

Looking for pricing, stock, or lifecycle information?

Click below to explore more details on WIN SOURCE:

 [View PT6901C on WIN SOURCE](#)

 [Texas Instruments](#) Information

Optimize Your Supply Chain with WIN SOURCE Solutions

-  Global Sourcing Solution
-  Obsolete Management
-  Cost Control Management
-  Shortage Management
-  Alternative Solution
-  Excess Inventory Management