



**THE DATASHEET OF
MP3373GM-Z**



DESCRIPTION

The MP3373 is a step-up controller with 8-channel external current sources designed for driving the WLED arrays for large size LCD panel backlighting applications.

The MP3373 employs peak current mode, fixed frequency architecture to provide robust operation with 9V to 40V input supply. The switching frequency is programmable by an external frequency setting resistor.

The MP3373 integrates the constant current control circuit to regulate each LED string current to the programmed value set by an external resistor. And the current matching can achieve 1.2% regulation accuracy between strings. Its low 200mV regulation voltage on LED current sources reduces power loss and improves efficiency.

To reduce inrush current and the stress of components, MP3373 employs the phase shift PWM dimming mode which can be disabled by pulling PSEN pin to GND.

MP3373 also includes UVLO, LED short/open protection, inductor/diode short protection and thermal shut down protection. All these faults are indicated by the fault flag signal.

The MP3373 is flexible for extending LED channels with two or three ICs in parallel with sharing one power stage. It is available in TSSOP-28 and SOIC-28 packages.

FEATURES

- 9V to 40V Input Voltage Range
- 8-Channel LED strings with external current balance
- 1.2% Current Matching Accuracy Between Strings
- Programmable Switching Frequency
- External PWM Dimming
- Selectable Phase Shift Function at PWM DIM Mode
- Open/Short LED Protection
- Short Inductor/Diode Protection
- Programmable Over-voltage Protection
- Thermal Shutdown
- Fault Flag Output
- Extendable LED Channels with Share One Set of Power Stage
- TSSOP-28 and SOIC-28 Packages

APPLICATIONS

- LCD Flat Panel Displays
- 2D/3D LCD TVs and Monitors

All MPS parts are lead-free and adhere to the RoHS directive. For MPS green status, please visit MPS website under Products, Quality Assurance page. "MPS" and "The Future of Analog IC Technology" are registered trademarks of Monolithic Power Systems, Inc.

TYPICAL APPLICATION

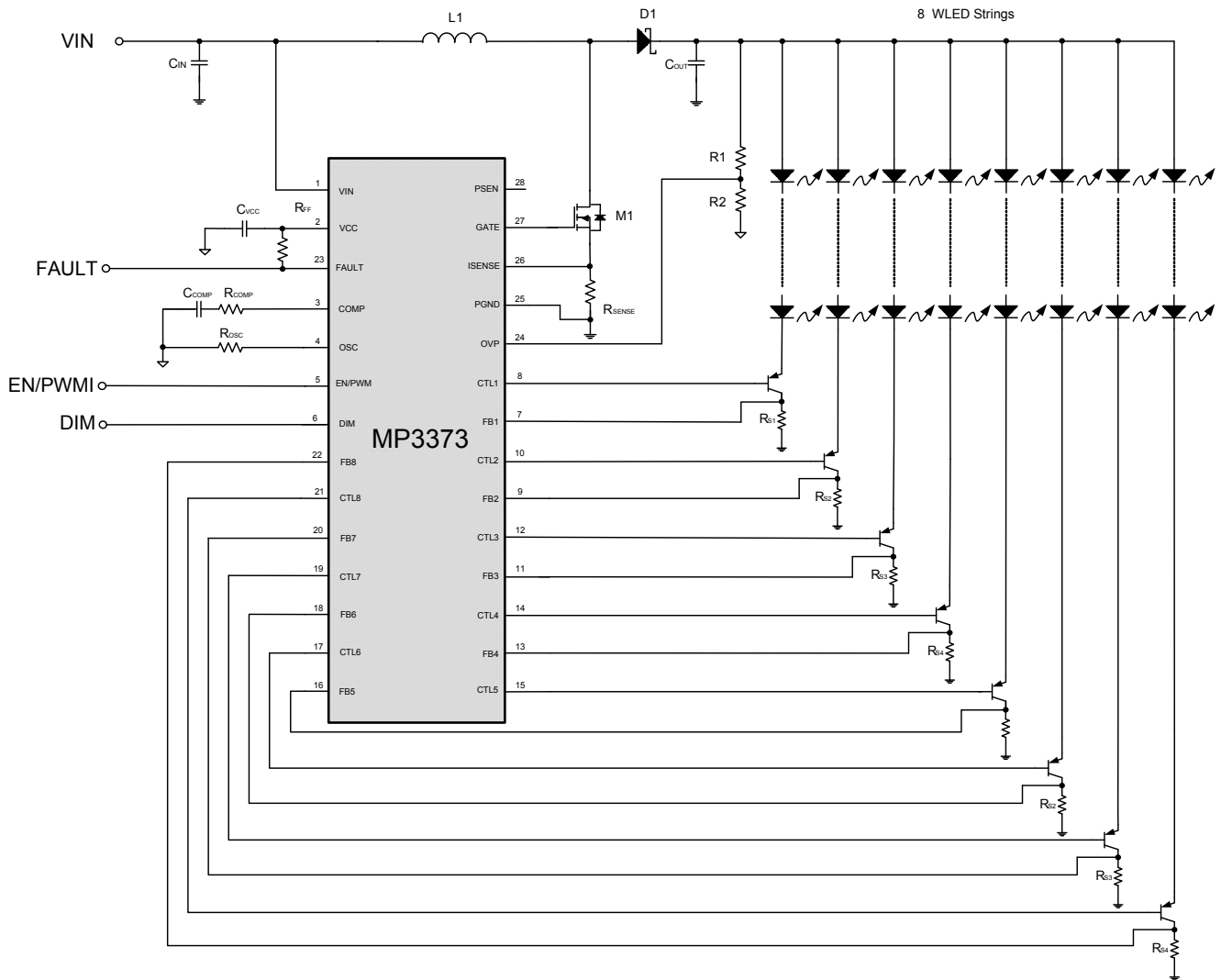

ORDERING INFORMATION

Part Number	Package	Top Marking
MP3373GY*	SOIC-28	MP3373
MP3373GM*	TSSOP-28	MP3373

* For phase shift function, please only order MP3373GY-C755 or MP3373GM-C755

PACKAGE REFERENCE

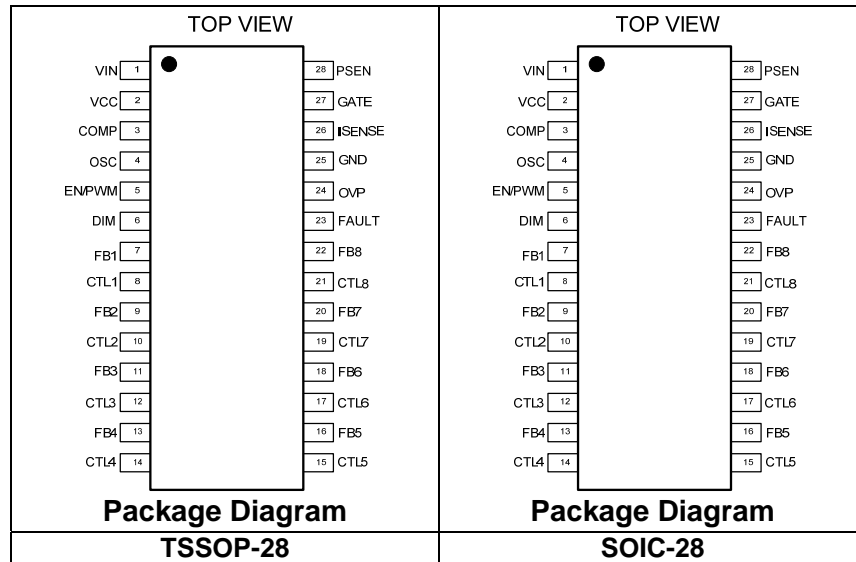

ABSOLUTE MAXIMUM RATINGS ⁽¹⁾

V_{IN}	-0.3V to 42V
$V_{GATE}, V_{CC}, V_{FAULT}$	-0.3V to 11V
V_{CTL1} to V_{CTL8}	-0.3V to 55V
All Other Pins	-0.3V to +6.3V
Continuous Power Dissipation ($T_A = +25^\circ\text{C}$) ⁽²⁾	
TSSOP-28	1.56 W
SOIC-28	2.08W
Junction Temperature	150°C
Lead Temperature	260°C
Storage Temperature	-65°C to +150°C

Recommended Operating Conditions ⁽³⁾

Supply Voltage V_{IN}	9V to 40V
Operating Junction Temp	-40°C to +125°C

Thermal Resistance ⁽⁴⁾ θ_{JA} θ_{JC}

TSSOP-28	80	30	°C/W
SOIC-28	60	30	°C/W

Notes:

- 1) Exceeding these ratings may damage the device.
- 2) The maximum allowable power dissipation is a function of the maximum junction temperature T_J (MAX), the junction-to-ambient thermal resistance θ_{JA} , and the ambient temperature T_A . The maximum allowable continuous power dissipation at any ambient temperature is calculated by P_D (MAX) = $(T_J$ (MAX) - T_A) / θ_{JA} . Exceeding the maximum allowable power dissipation will cause excessive die temperature, and the regulator will go into thermal shutdown. Internal thermal shutdown circuitry protects the device from permanent damage.
- 3) The device is not guaranteed to function outside of its operating conditions.
- 4) Measured on JESD51-7, 4-layer PCB.

ELECTRICAL CHARACTERISTICS ⁽⁵⁾
 $V_{IN} = 12V$, $V_{EN} = 5V$, $T_A = 25^\circ C$, unless otherwise noted.

Parameters	Symbol	Condition	Min	Typ	Max	Units
Operating Input Voltage	V_{IN}		9		40	V
Supply Current (Quiescent)	I_Q	$V_{IN}=12V$, $V_{EN}=5V$, no load with switching		5		mA
Supply Current (Shutdown)	I_{ST}	$V_{EN}=0V$, $V_{IN}=12V$			1	μA
LDO Output Voltage	V_{CC}	$V_{EN}=5V$, $11V < V_{IN} < 30V$, $0 < I_{VCC} < 10mA$	9	10	11	V
Input VCC UVLO Threshold	V_{IN_UVLO}	Rising Edge	7.1	7.8	8.5	V
Input VCC UVLO Hysteresis				200		mV
EN High Voltage	V_{EN_HIGH}	V_{EN} Rising	1.5			V
EN Low Voltage	V_{EN_LOW}	V_{EN} Falling			0.6	V
STEP-UP CONVERTER						
Gate Driver Impedance (Sourcing)		$V_{CC}=10V$, $I_{GATE}=10mA$		4		Ω
Gate Driver Impedance (Sinking)		$V_{CC}=10V$, $I_{GATE}=10mA$		2		Ω
GATE Voltage	V_{GATE}	$11V < V_{IN} < 30V$		10		V
Switching Frequency	f_{SW}	$R_{OSC} = 100k\Omega$	135	168	201	kHz
		$R_{OSC} = 20k\Omega$		785		kHz
OSC Voltage	V_{OSC}		1.18	1.23	1.28	V
Minimum On Time	T_{ON_MIN}	PWM Mode, no pulse skipping happens		200		ns
Maximum Duty Cycle	D_{MAX}		90			%
ISENSE Limit		Max Duty Cycle	195	255	315	mV
CTLX Regulation Voltage	V_{CTLX}			320		mV
CTLX Maxim Sink Current	I_{CTLX}		10			mA
COMP Source Current Limit	I_{COMP_SOLI}			70		μA
COMP Sink Current Limit	I_{COMP_SILI}			8		μA
Analog DIMMING						
Minimum Dimming Threshold	V_{DIM_MIN}		0.375	0.4	0.425	V
Maximum Dimming Threshold	V_{DIM_MAX}		1.455	1.5	1.545	V
PWM DIMMING						
PWM Signal High Threshold	V_{PWM_HIGH}		1.6			V

ELECTRICAL CHARACTERISTICS (continued)
 $V_{IN} = 12V$, $V_{EN} = 5V$, $T_A = 25^{\circ}C$, unless otherwise noted.

Parameters	Symbol	Condition	Min	Typ	Max	Units
PWM Signal Low Threshold	V_{PWM_LOW}				0.3	V
EN/PWMI Low to Shutdown Delay Time	T_{SD_PWML}		20			ms
LED CURRENT REGULATION						
FBX Regulation Average Voltage	V_{FBX}		193	200	207	mV
FBX Regulation Voltage matching				1.0	1.2	%
Phase Shift						
Phase Shift Delay Between Each Two Adjacent String		8-string current sink used,		45		°
		6-string current sink used 7/8-string disabled.		60		°
		4-string current sink used 5/6/7/8-string disabled.		90		°
PROTECTION						
OVP Over Voltage Threshold	V_{OVP_OV}	Rising Edge	2.43	2.5	2.57	V
OVP Over Voltage Hysteresis				100		mV
OVP UVLO threshold	V_{OVP_UV}	Step-up Converter Fails		80		mV
OVP Over Voltage Latch-Off Threshold	V_{OVP_SD}	Rising Edge	2.9	3	3.1	V
CTLX UVLO Threshold	V_{CTLX_UV}		170	205	240	mV
FAULT Flag Pull Down Resistance	R_{FF}			20		Ω
Latch Off Current Limit	V_{LMT_SD}		378	430	472	mV
Thermal Shutdown Threshold	T_{ST}			150		°C
Thermal Shutdown Hysteresis				25		
CTLX Over Voltage Threshold	V_{CTLX_OV}		5.5	6	6.5	V

Notes:

5) Matching is defined as the difference of the maximum to minimum current divided by 2 times average currents.

TYPICAL CHARACTERISTICS

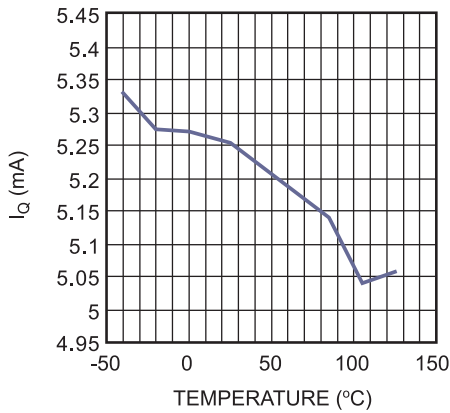
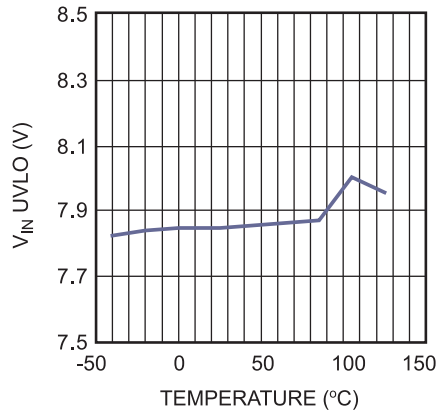
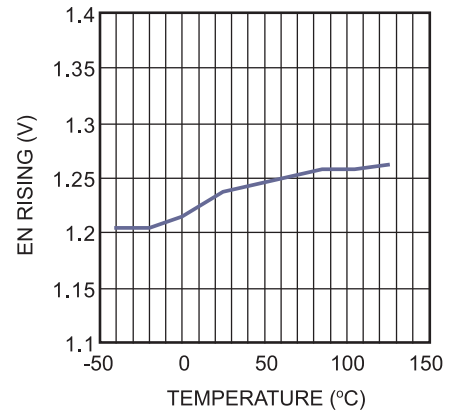
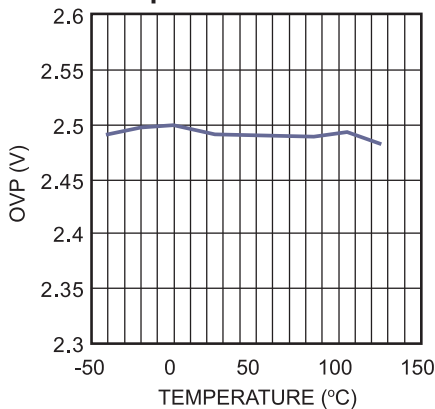
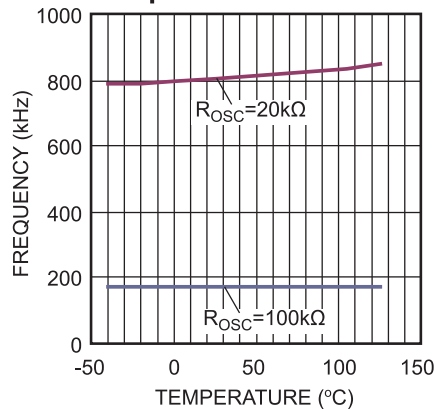
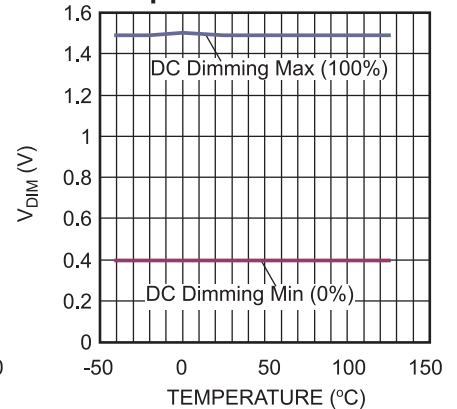
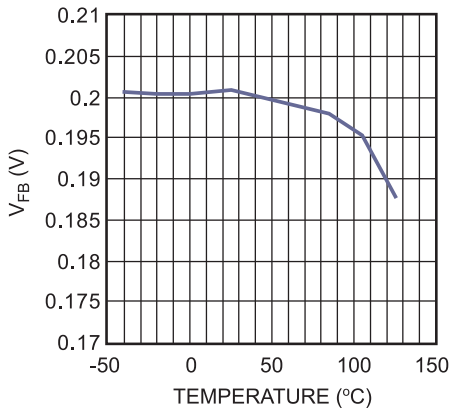
 I_Q vs. Temperature

 V_{IN} UVLO vs. Temperature

EN Rising vs. Temperature

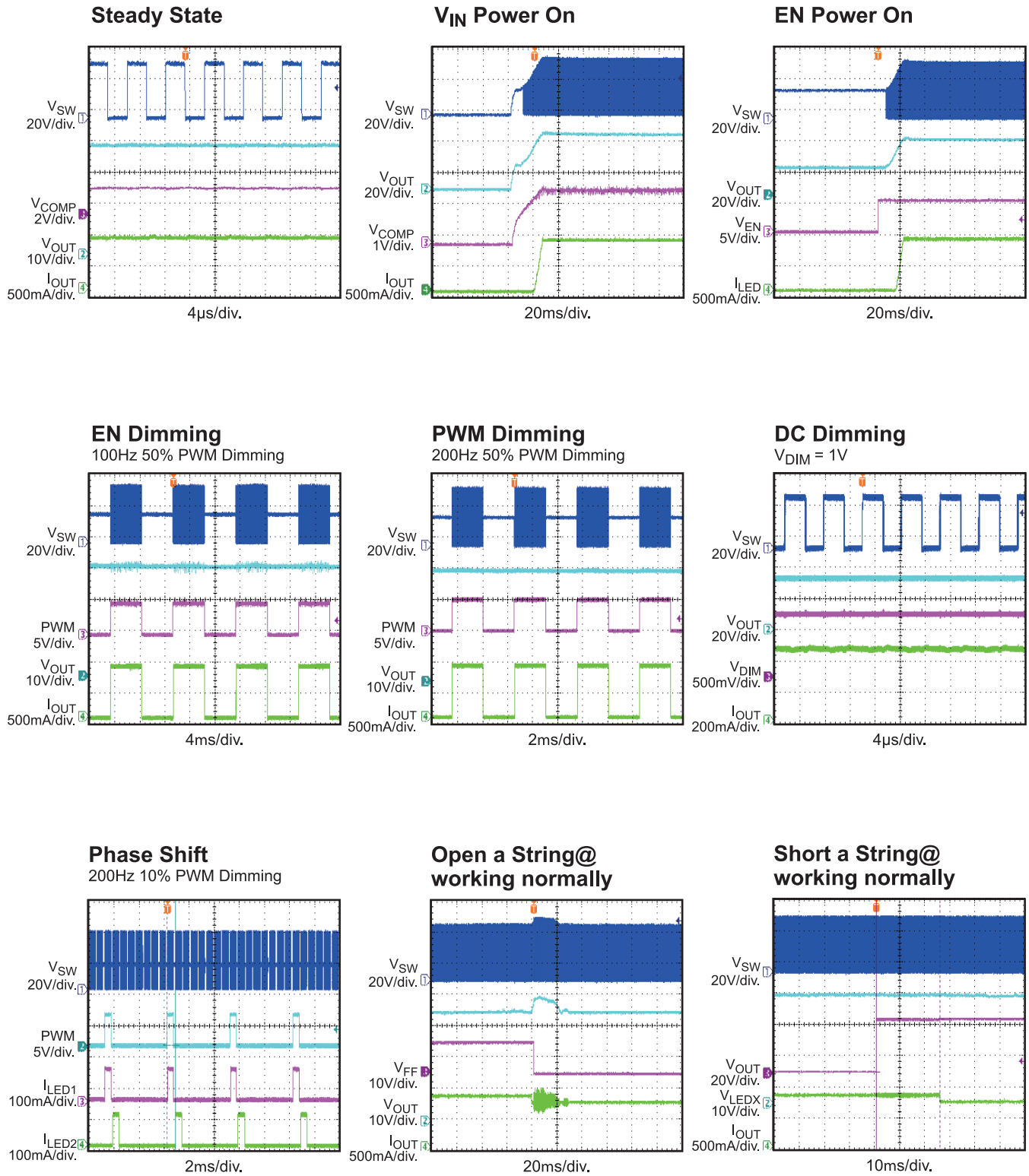
OVP Protection Point vs. Temperature

Operation Frequency vs. Temperature

DC Dimming Range vs. Temperature

FB vs. Temperature

TYPICAL PERFORMANCE CHARACTERISTICS

$V_{IN} = 18V$, 10 LEDs in series, 8 strings parallel, 100mA/string, unless otherwise noted.



TYPICAL PERFORMANCE CHARACTERISTICS

$V_{IN} = 18V$, 10 LEDs in series, 8 strings parallel, 100mA/string, unless otherwise noted.

Short Inductor

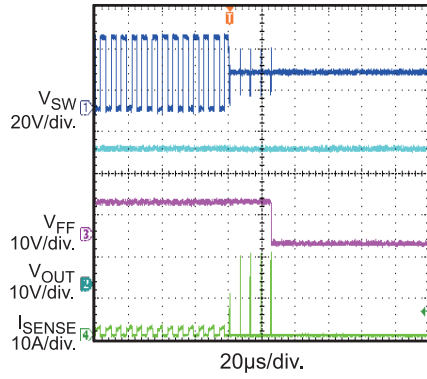

Short Diode

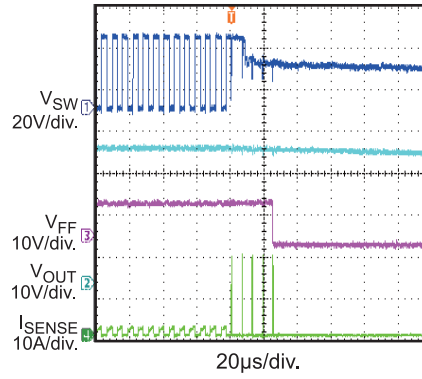

PIN FUNCTIONS

Pin #	Name	Description
1	VIN	Power Supply Input. Drive VIN with 9V to 40V power source. Must be locally bypassed.
2	VCC	The Internal 10V Linear Regulator Output. VCC provides power supply for the internal MOSFET switch gate driver and the internal control circuitry. Bypass VCC to GND with a ceramic capacitor.
3	COMP	Step-up Converter Compensation Pin. This pin is used to compensate the regulation control loop.
4	OSC	Switching Frequency Set. Connect a resistor between OSC and GND to set the step-up converter switching frequency.
5	EN/PWM	Enable Control and PWM Dimming Signal Input. Do not let this pin floating.
6	DIM	Dimming Input Pin. To use PWM dimming mode, apply an external PWM signal with amplitude greater than 1.6V on this pin. To use analog dimming mode, apply a DC voltage range from 0.4V to 1.5V on this pin linearly to set LED current from 0% to 100%.
7	FB1	LED Current Feedback Pin. Detect the channel 1 LED current.
8	CTL1	External Transistor Control Pin. Connect it to the base of external transistor to regulate the channel 1 LED current.
9	FB2	LED Current Feedback Pin. Detect the channel 2 LED current.
10	CTL2	External Transistor Control Pin. Connect it to the base of external transistor to regulate the channel 2 LED current.
11	FB3	LED Current Feedback Pin. Detect the channel 3 LED current.
12	CTL3	External Transistor Control Pin. Connect it to the base of external transistor to regulate the channel 3 LED current.
13	FB4	LED Current Feedback Pin. Detect the channel 4 LED current.
14	CTL4	External Transistor Control Pin. Connect it to the base of external transistor to regulate the channel 4 LED current.
15	CTL5	External Transistor Control Pin. Connect it to the base of external transistor to regulate the channel 5 LED current.

PIN FUNCTIONS *(continued)*

Pin #	Name	Description
16	FB5	LED Current Feedback Pin. Detect the channel 5 LED current.
17	CTL6	External Transistor Control Pin. Connect it to the base of external transistor to regulate the channel 6 LED current.
18	FB6	LED Current Feedback Pin. Detect the channel 6 LED current.
19	CTL7	External Transistor Control Pin. Connect it to the base of external transistor to regulate the channel 7 LED current.
20	FB7	LED Current Feedback Pin. Detect the channel 7 LED current.
21	CTL8	External Transistor Control Pin. Connect it to the base of external transistor to regulate the channel 8 LED current.
22	FB8	LED Current Feedback Pin. Detect the channel 8 LED current.
23	FAULT	Fault Flag Output Pin. This pin is the open drain of internal N-MOSFET. FAULT is pulled up to external DC level at normal mode. When fault protection is triggered, internal MOSFET turns on and the FAULT pin is pulled to GND.
24	OVP	Over-voltage Protection Input. Connect a resistor divider from output to this pin to program the OVP threshold.
25	PGND	Step-up Converter Power Ground.
26	ISENSE	Current Sense Input. During normal operation, this pin detects the inductor current by a sensing resistor for peak current mode control and over current protection. If this pin is not used in extending application with other master MP3373, tie this pin to GND, do not let this pin floating.
27	GATE	Step-up Converter Power Switch Gate Output. This pin drives the external power N-MOS device.
28	PSEN	Phase Shift Function Enable Pin. Leave this pin float, phase shift function is enabled. To disable the phase shift function by pulling this pin to GND.

OPERATION

The MP3373 employs a programmable constant-frequency, peak current mode step-up converter with 8 channels regulated current control circuit to drive an array of up to 8 strings of white LEDs.

Internal 10V Regulator

The MP3373 includes an internal linear regulator (VCC). When VIN is greater than 10V, this regulator offers a 10V power supply for the internal MOSFET switch gate driver and the internal control circuitry. The VCC voltage drops to 0V when the chip shuts down. The MP3373 features Under Voltage Lockout. The chip is disabled until VCC exceeds the UVLO threshold. And the hysteresis of UVLO is approximately 200mV.

System Startup

When enabled, the MP3373 checks the topology connection first. The chip monitors the over-voltage protection (OVP) pin to see if the Schottky diode is not connected or if the boost output is shorted to GND. An OVP voltage of higher than 80mV makes the chip switching normally, otherwise the switching is disabled. In addition, the MP3373 also checks other safety limits, including UVLO and over-temperature protection (OTP), over-current protection after passing the OVP test. If all the protection tests pass, the chip then starts boosting the step-up converter with an internal soft-start.

It is recommended that the enable signal occurs after the establishment of the input voltage and PWM dimming signal during the start-up sequence to avoid large inrush current.

Step-Up Converter

The converter operating frequency is programmable (from 100kHz to 1MHz) with an external resistor connected to the OSC pin. This helps to optimize the size of external components and the efficiency.

At the beginning of each switching cycle, the internal clock turns on the external MOSFET (In normal operation, the minimum turn on time is 200ns). A stabilizing ramp added to the output of the current sense amplifier prevents sub-harmonic oscillations for duty cycles greater

than 50 percent. This result is fed into the PWM comparator. When the summed voltage reaches the output voltage of the error amplifier (V_{COMP}), the external MOSFET turns off.

The output voltage of the internal error amplifier is an amplified signal of the difference between the reference voltage and the feedback voltage. The converter automatically chooses the lowest active LEDX pin voltage to provide a high-enough bus voltage to power all the LED arrays.

If the feedback voltage drops below the reference, the output of the error amplifier increases. It will result in more current flowing through the MOSFET, thus increasing the power delivered to the output. This forms a closed loop that regulates the output voltage.

Under light-load operation, especially in the case of $V_{OUT} \approx V_{IN}$, the converter runs in pulse-skipping mode where the MOSFET turns on for a minimum on-time of approximately 200ns, and then the converter discharges the power to the output for the remaining period. The external MOSFET remains off until the output voltage needs to be boosted again.

Dimming Control

The MP3373 provides two dimming methods: PWM and analog dimming mode.

For PWM dimming, apply a PWM signal to EN/PWM pin or DIM pin. The LED current is chopped by this PWM signal and the average LED current is equal to $I_{set} * D_{dim}$ where D_{dim} is the duty cycle of PWM dimming signal and I_{set} is the LED current amplitude.

For analog dimming, apply a DC voltage range from 0.4V to 1.5V on this pin linearly to set LED current from 0% to 100%.

Open String Protection

The open string protection is achieved through the over voltage protection. If one or more strings are open, the respective CTLX pin voltages are low and the IC keeps charging the output voltage until it reaches OVP threshold. Then the part will mark off the open strings whose CTLX pin voltage is less than V_{CTLX_UV}

threshold value. Once the mark-off operation completes, the remaining LED strings will force the output voltage back into tight regulation. The string with the highest voltage drop is the ruling string during output regulation. The MP3373 always tries to light at least one string and if all strings in use are open, the MP3373 shuts down the step-up converter. The part will maintain mark-off information until the part shuts down.

Short String Protection

The MP3373 monitors the CTLX pin voltages to determine if a short string fault has occurred. If one or more strings are shorted, the respective CTLX pins tolerate high voltage stress. If the CTLX pin voltage is higher than short protection threshold for 4096 switching clocks, the fault string is marked OFF and disabled. Once a string is marked OFF, it disconnects from the closed control loop of feedback. The marked LED strings shut off completely until the part restarts. If all strings are shorted together, the Short String Protection is disabled.

Inductor/Diode short Protection

To prevent the IC and external MOSFET damage when external inductor/diode is shorted, MP3373 provides the protection mode by detecting the current flowing through power MOSFET. In this mode, when the current sense voltage across sensing resistor (connected between MOSFET and GND) hits V_{LMT_SD} value and lasts for 4 switching cycles, the IC turns off and latches.

Thermal Shutdown Protection

To prevent the IC operate at exceedingly high temperature, thermal shutdown is implemented in this chip by detecting the silicon die temperature. The IC shutdowns when the die temperature exceeds the upper threshold and recovers to normal operation when die temperature drops below lower threshold. Typically, the hysteresis value is 25°C

Over Voltage Protection

In some unexpected conditions, if OVP voltage is greater than 2.5V, the gate driver stops switching and thus, the output voltage starts discharging. When the OVP voltage drops lower than lower threshold caused by a OVP

hysteresis value, typical value 100mV, the gate driver resumes to normal switching again.

If OVP voltage is greater than 3V for 4 switching cycles, MP3373 will turn off and latch until VIN or EN is reset.

Unused Strings Connection

In default normal mode, all 8-channel current sources are regulated in a closed feedback control loop. In some cases, if one or more channels are not used, connect the corresponding CTLX pin to GND. MP3373 will detect it automatically during IC startup and remove the unused channels from the closed control loop.

Phase Shift Function

If PSEN pin is float, in PWM dimming mode, all 8-channel current sources are phase-shifted by 45° between each two channels in order to reduce inrush current and eliminate audible noise, i.e., Channel 1 directly follows PWM signal input, Channel 2 lags Channel 1 by 45° and Channel 3 lags Channel 2 by 45°. If some channels are unused by connecting respective CTLX to GND, the phase shift phase detection circuit can automatically change the phase shift delay time. For example, if two channels are not used by connecting CTRL7 and CTRL8 pin to GND, the phase shift delay is automatically changed to 60°. If four channels are not used by connecting CTRL5, CTRL6, CTRL7 and CTRL8 pin to GND, the phase shift delay is automatically changed to 90°. Note that marked-off channels caused by short/open LED string protection during operation will not change the phase shift delay time.

If phase shift function is not used, connect PSEN pin to GND.

Fault Flag Indication

At normal mode, the FAULT pin is pulled to high by pull-up resistor. When the short/open LED protection, OVP protection, inductor/diode short protection, or thermal shutdown protection condition is detected, the FAULT pin is pulled to

GND which provides a fault state to the master system. Note that disabling the unused channels by connecting CTLX to GND will not change the FAULT normal condition.

FUNCTION BLOCK DIAGRAM

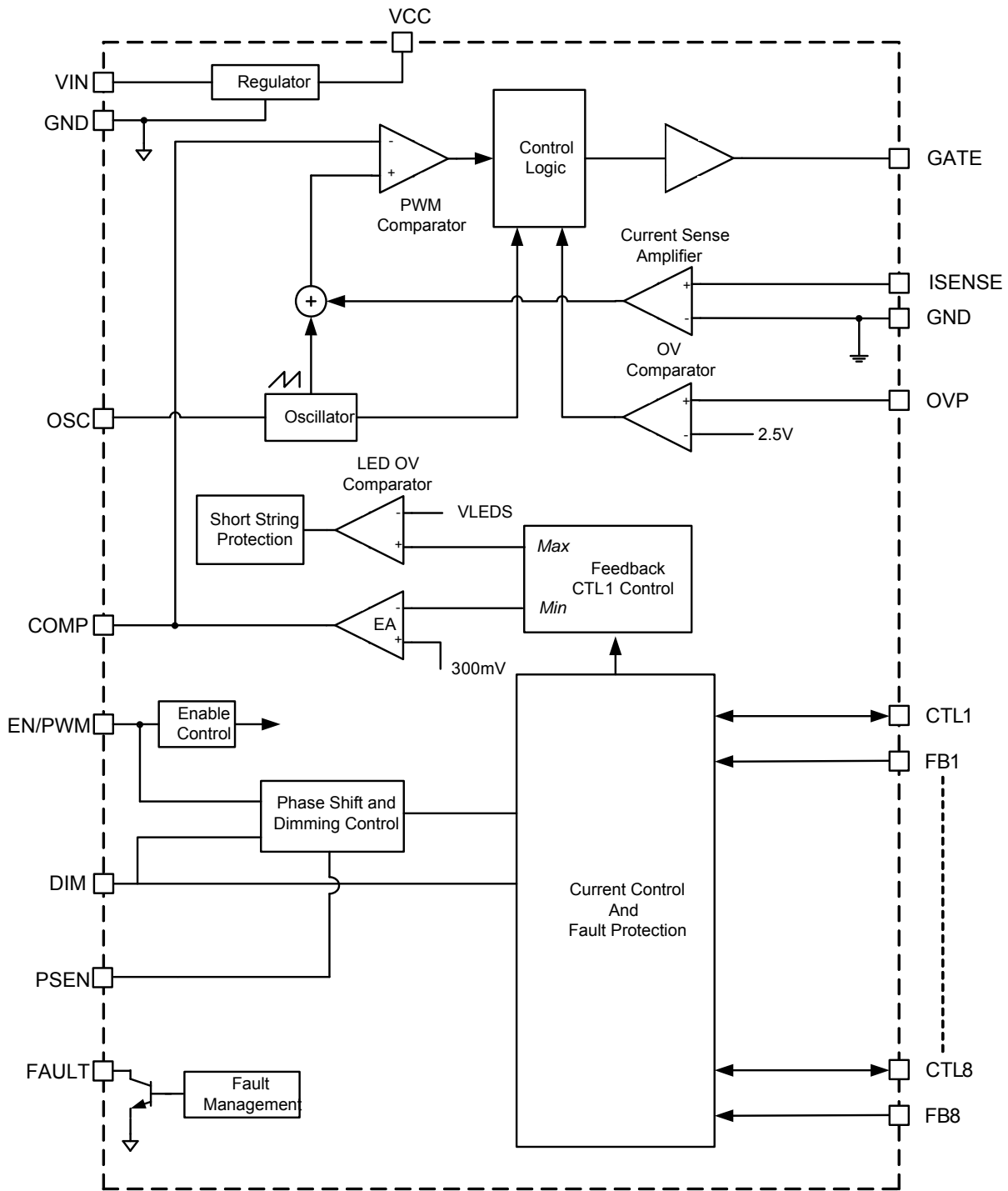

Figure 1: MP3373 Functional Block Diagram

APPLICATION INFORMATION

Selecting the Switching Frequency

The switching frequency of the step-up converter is recommended from 100kHz to 1MHz for most of application. An oscillator resistor on OSC pin sets the internal oscillator frequency for the step-up converter according to the below equation:

$$F_{SW}(kHz) = \frac{16800}{R_{OSC}(k\Omega)}$$

For $R_{OSC}=100k\Omega$, the switching frequency is set to 168 kHz.

Setting the LED Current

The LED string currents are identical and set through the current sense resistor on the FB pin.

$$I_{LED}(mA) = \frac{1 + \beta}{\beta} \frac{200(mV)}{R_{FB}}$$

Where β is the gain of transistor, for $R_{FB} = 2\Omega, \beta=100$, the LED current is set to 101mA. The FB pin can not be open.

Selecting the Input Capacitor

The input capacitor reduces the surge current drawn from the input supply and the switching noise from the device. The input capacitor impedance at the switching frequency should be less than the input source impedance to prevent the high-frequency switching current from passing through to the input. Use ceramic capacitors with X5R or X7R dielectrics for their low ESR and small temperature coefficients. For most applications, use a $4.7\mu F$ ceramic capacitor in parallel with a $220\mu F$ electrolytic capacitor.

Selecting the Inductor and Current Sensing Resistor

The MP3373 requires an inductor to supply a higher output voltage while being driven by the input voltage. A larger value inductor results in less ripple current, resulting in lower peak inductor current and reducing stress on the N-channel MOSFET. However, the larger value inductor has a larger physical size, higher series resistance, and lower saturation current.

Choose an inductor that does not saturate under the worst-case load conditions. Select the minimum inductor value to ensure that the boost converter works in continuous conduction mode with high efficiency and good EMI performance.

Calculate the required inductance value using the equation:

$$L \geq \frac{\eta \times V_{OUT} \times D \times (1-D)^2}{2 \times f_{SW} \times I_{LOAD}}$$

$$D = 1 - \frac{V_{IN}}{V_{OUT}}$$

Where V_{IN} and V_{OUT} are the input and output voltages, f_{SW} is the switching frequency, I_{LOAD} is the LED load current, and η is the efficiency.

The switching current is usually used for the peak current mode control. In order to avoid hitting the current limit, the voltage across the sensing resistor R_{SENSE} must be less than 75% of the worst-case current-limit voltage, V_{SENSE} .

$$R_{SENSE} = \frac{0.75 \times V_{SENSE}}{I_{L(PEAK)}}$$

$$I_{L(PEAK)} = \frac{V_{OUT} \times I_{LOAD}}{\eta V_{IN}} + \frac{V_{IN} \times (V_{OUT} - V_{IN})}{2 \times L \times F_{SW} \times V_{OUT}}$$

Where $I_{L(PEAK)}$ is the peak value of the inductor current. V_{SENSE} is shown in Figure 2.

V_{SENSE} vs. Duty

Duty(%)	V _{LIMIT} (mV)
10.00	380.3
20.00	365.6
30.00	350.9
40.00	336.2
50.00	321.5
60.00	306.8
70.00	292.1
80.00	277.4
90.00	262.7



Figure 2: V_{SENSE} vs Duty Cycle

Selecting the Power MOSFET

The MP3373 is capable of driving a wide variety of N-channel power MOSFETS. The critical parameters of selection of a MOSFET are:

1. Maximum drain-to-source voltage, $V_{DS(MAX)}$
2. Maximum current, $I_{D(MAX)}$
3. On-resistance, $R_{DS(ON)}$

4. Gate source charge Q_{GS} and gate drain charge Q_{GD}
5. Total gate charge, Q_G

Ideally, the off-state voltage across the MOSFET is equal to the output voltage. Considering the voltage spike when it turns off, $V_{DS(MAX)}$ should be greater than 1.5 times of the output voltage.

The maximum current through the power MOSFET occurs at the minimum input voltage and the maximum output power. The maximum RMS current through the MOSFET is given by

$$I_{RMS(MAX)} = I_{IN(MAX)} \times \sqrt{D_{MAX}}, \text{ where:}$$

$$D_{MAX} \approx \frac{V_{OUT} - V_{IN(MIN)}}{V_{OUT}}$$

The current rating of the MOSFET should be greater than $1.5 \times I_{RMS}$

The ON resistance of the MOSFET determines the conduction loss, which is given by:

$$P_{cond} = I_{RMS}^2 \times R_{DS(on)} \times k$$

Where k is the temperature coefficient of the MOSFET.

The switching loss is related to Q_{GD} and Q_{GS1} which determine the commutation time. Q_{GS1} is the charge between the threshold voltage and the plateau voltage when a driver charges the gate, which can be read in the chart of V_{GS} vs. Q_G of the MOSFET datasheet. Q_{GD} is the charge during the plateau voltage. These two parameters are needed to estimate the turn-on and turn-off losses.

$$P_{SW} = \frac{Q_{GS1} \times R_G}{V_{DR} - V_{TH}} \times V_{DS} \times I_{IN} \times f_{SW} +$$

$$\frac{Q_{GD} \times R_G}{V_{DR} - V_{PLT}} \times V_{DS} \times I_{IN} \times f_{SW}$$

Where V_{TH} is the threshold voltage, V_{PLT} is the plateau voltage, R_G is the gate resistance, and V_{DS} is the drain-source voltage. Please note that calculating the switching loss is the most difficult part in the loss estimation. The formula above provides a simplified equation. For more accurate estimates, the equation becomes much more complex.

The total gate charge, Q_G , is used to calculate the gate drive loss. The expression is

$$P_{DR} = Q_G \times V_{DR} \times f_{SW}$$

Where V_{DR} is the drive voltage.

Selecting the Output Capacitor

The output capacitor keeps the output voltage ripple small and ensures feedback loop stability. The output capacitor impedance must be low at the switching frequency. Ceramic capacitors with X7R dielectrics are recommended for their low ESR characteristics. For most applications, a $4.7\mu F$ ceramic capacitor in parallel with a $470\mu F$ electrolytic capacitor will suffice.

Setting the Over Voltage Protection

The open string protection is achieved through the detection of the voltage on the OVP pin. In some cases, an LED string failure results in the feedback voltage always zero. The part then keeps boosting the output voltage higher and higher. If the output voltage reaches the programmed OVP threshold, the protection will be triggered.

To ensure the chip functions properly, select the resistor values for the OVP resistor divider to provide an appropriate set voltage. The recommended OVP point is about 1.1 to 1.2 times higher than the output voltage for normal operation.

$$V_{OVP} = 2.5V \times (R_{HIGH} + R_{LOW}) / R_{LOW}$$

Layout Considerations

Careful attention must be paid to the PCB board layout and components placement. Proper layout of the high frequency switching path is critical to prevent noise and electromagnetic interference problems. The loop of external MOSFET (M1), output diode (D1), and output capacitor (C3) is flowing with high frequency pulse current. It must be as small as possible (See Figure 3).

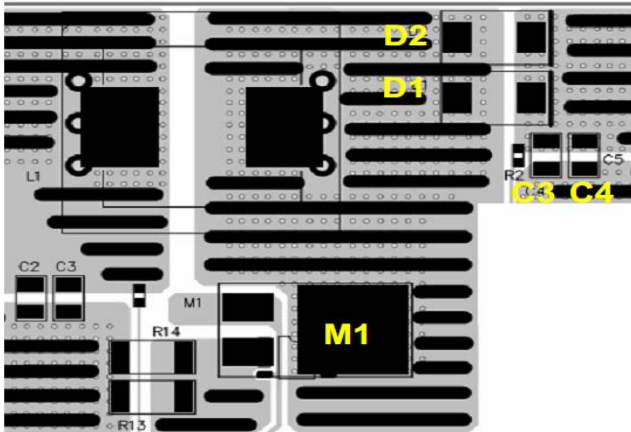

Figure 3: Layout Consideration

TYPICAL APPLICATION CIRCUITS

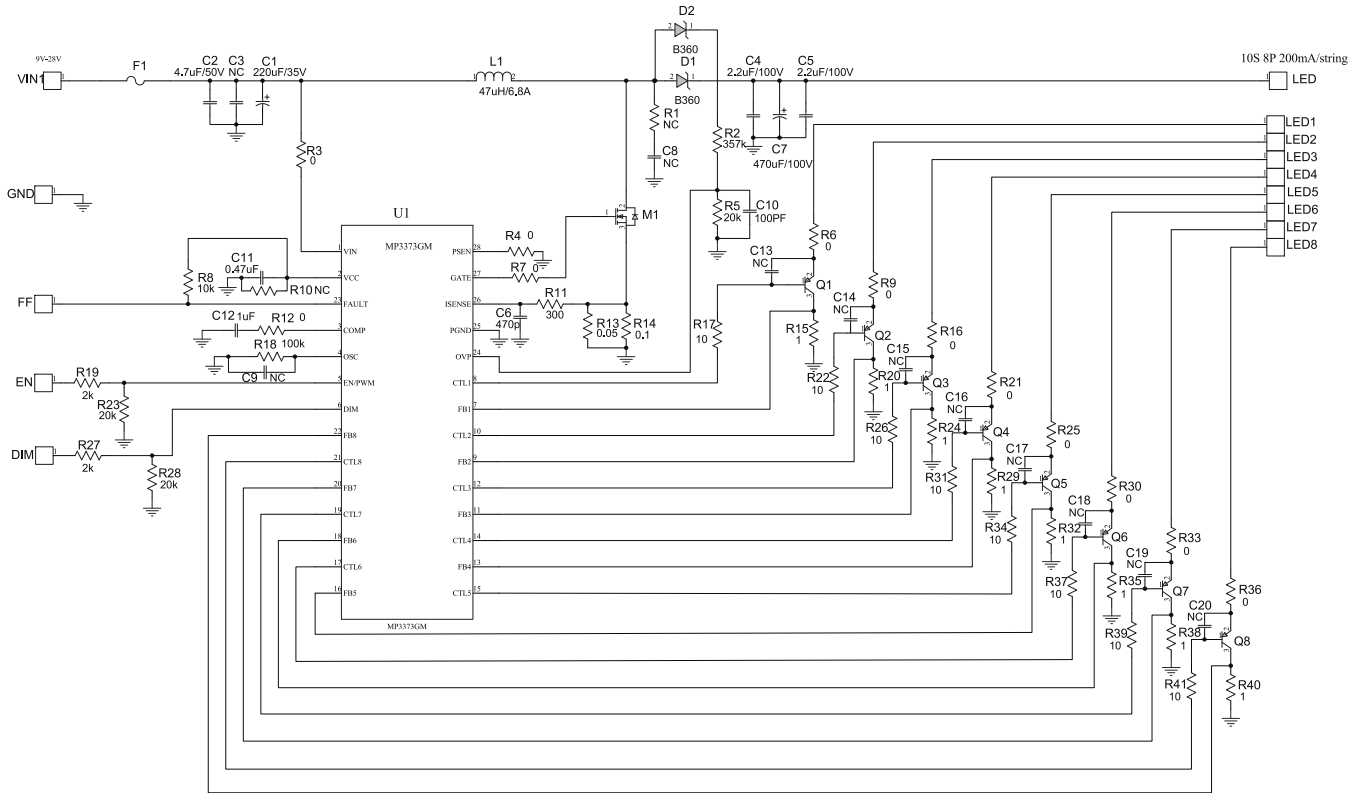
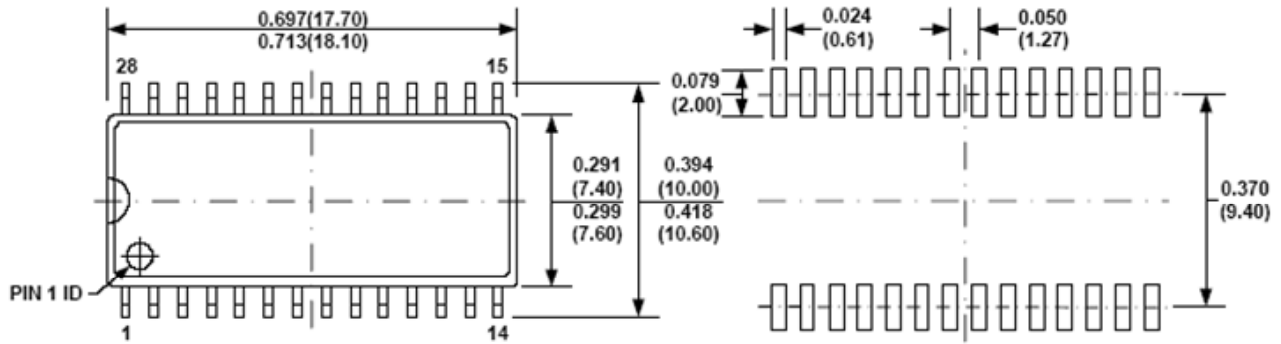

Figure 4: Driving 8 LED Strings

PACKAGE INFORMATION

SOIC-28



TOP VIEW

RECOMMENDED LAND PATTERN



FRONT VIEW

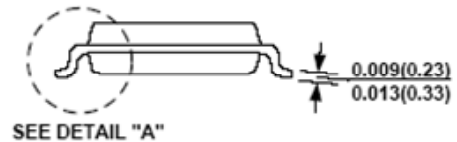

SIDE VIEW

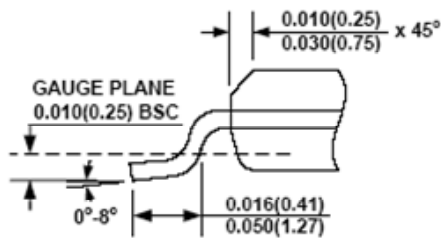

DETAIL "A"

NOTE:

- 1) CONTROL DIMENSION IS IN INCHES. DIMENSION IN BRACKET IS IN MILLIMETERS.
- 2) PACKAGE LENGTH DOES NOT INCLUDE MOLD FLASH, PROTRUSIONS OR GATE BURRS.
- 3) PACKAGE WIDTH DOES NOT INCLUDE INTERLEAD FLASH OR PROTRUSIONS.
- 4) LEAD COPLANARITY (BOTTOM OF LEADS AFTER FORMING) SHALL BE 0.10 MILLIMETERS MAX.
- 5) DRAWING CONFORMS TO JEDEC MS-013, VARIATION AE.
- 6) DRAWING IS NOT TO SCALE.

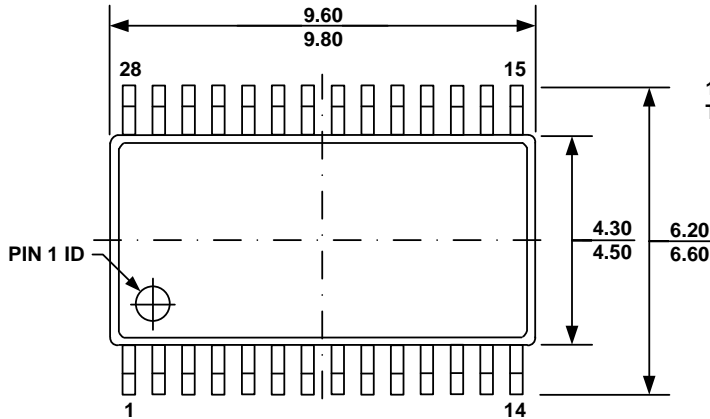
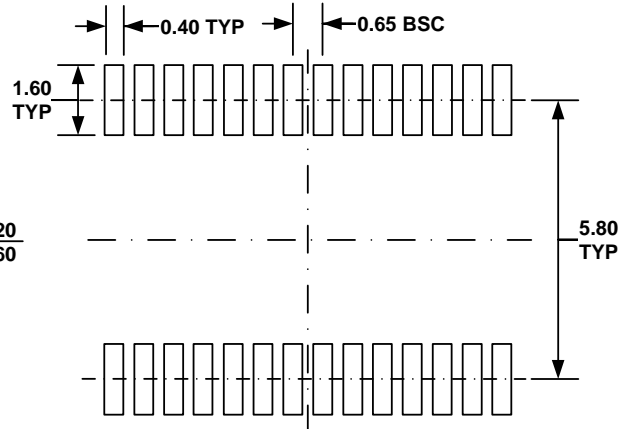
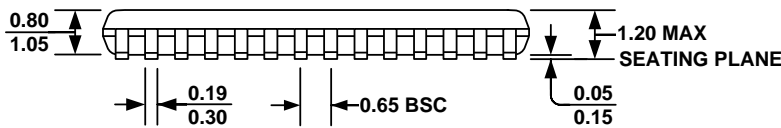
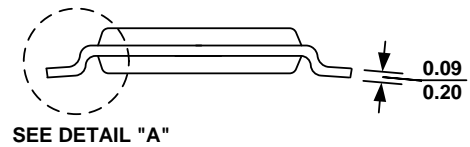
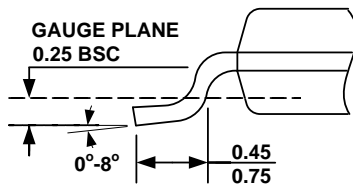
TSSOP-28

TOP VIEW

RECOMMENDED LAND PATTERN

FRONT VIEW

SIDE VIEW

DETAIL "A"
NOTE:

- 1) ALL DIMENSIONS ARE IN MILLIMETERS.
- 2) PACKAGE LENGTH DOES NOT INCLUDE MOLD FLASH, PROTRUSION OR GATE BURR.
- 3) PACKAGE WIDTH DOES NOT INCLUDE INTERLEAD FLASH OR PROTRUSION.
- 4) LEAD COPLANARITY (BOTTOM OF LEADS AFTER FORMING) SHALL BE 0.10 MILLIMETERS MAX.
- 5) DRAWING CONFORMS TO JEDEC MO-153, VARIATION AE.
- 6) DRAWING IS NOT TO SCALE.

NOTICE: The information in this document is subject to change without notice. Please contact MPS for current specifications. Users should warrant and guarantee that third party Intellectual Property rights are not infringed upon when integrating MPS products into any application. MPS will not assume any legal responsibility for any said applications.

Looking for pricing, stock, or lifecycle information?

Click below to explore more details on WIN SOURCE:

- ⊖ [View MP3373GM-Z on WIN SOURCE](#)
- ⊖ [Monolithic Power Systems Inc. Information](#)

Optimize Your Supply Chain with WIN SOURCE Solutions

- ✓ Global Sourcing Solution
- ✓ Obsolete Management
- ✓ Cost Control Management
- ✓ Shortage Management
- ✓ Alternative Solution
- ✓ Excess Inventory Management