



**THE DATASHEET OF
MKP386M447125JT5**



Metallized Polypropylene Film Capacitor Radial Snubber Type

FEATURES

- Reduce EMI by clamping voltage and current ringing
- High pulse strength (dV/dt up to 2500 V/μs)
- Low inductance construction (low ESL)
- Low ESR
- Material categorization:
for definitions of compliance please see www.vishay.com/doc?99912



RoHS
COMPLIANT
HALOGEN
FREE
GREEN
(5-2008)

APPLICATIONS

- Photovoltaic and wind inverters
- Motor drives
- Frequency converters
- Direct mount on IGBT modules

QUICK REFERENCE DATA	
Rated capacitance range	0.047 μF to 10 μF
Capacitance tolerance	± 5 %/± 10 %
Rated (DC) voltage, U _{NDC}	700 V, 850 V, 1000 V, 1250 V, 1600 V, 2000 V, 2500 V
Climatic testing class	55/105/56
Rated temperature	85 °C
Maximum permissible case temperature	105 °C
Rated (AC) voltage	420 V, 400 V to 450 V, 425 V to 500 V, 450 V to 550 V, 450 V to 600 V, 700 V, 800 V
Reference standards	IEC 60384-17
Dielectric	Polypropylene film
Electrodes	Metallized film
Construction	Series construction
Encapsulation	Flame retardant plastic case and epoxy resin sealed
Terminals	Tinned coated copper
Self inductance (L _S)	< 0.7 nH per mm of lead spacing
Withstanding DC voltage between terminals ⁽¹⁾	1.6 U _{RDC} for 60 s (maximum rise time 1000 V/s; cut off current 10 mA)
Test voltage between terminals and case	1.4 U _{RAC} + 2000 V _{DC} for 60 s
Insulation resistance	RC between leads, at 500 V after 1 min: > 100 GΩ for C ≤ 0.33 μF > 30 000 s for C > 0.33 μF
Performance grade	Grade 1 (long life)
Stability grade	Grade 2
Life time expectancy	Operation life > 300 000 h - failure rate < 5 FIT (40 °C and 0.5 x U _R)
Marking	C-value, tolerance code, rated voltage, manufacturer's emblem, code for dielectric material, manufacturer's type designation, year and week, manufacturer's location

Notes

- For more detailed data and test requirements contact dc-film@vishay.com
- For general information like characteristics and definitions used for film capacitors follow the link: www.vishay.com/doc?28147
- ⁽¹⁾ See document "Voltage Proof Test for Metallized Capacitors" (www.vishay.com/doc?28169)

DC VOLTAGE RATINGS							
U _{RDC}	700 V _{DC}	850 V _{DC}	1000 V _{DC}	1250 V _{DC}	1600 V _{DC}	2000 V _{DC}	2500 V _{DC}
U _{RAC}	420 V _{AC}	450 V _{AC}	500 V _{AC}	550 V _{AC}	600 V _{AC}	700 V _{AC}	800 V _{AC}

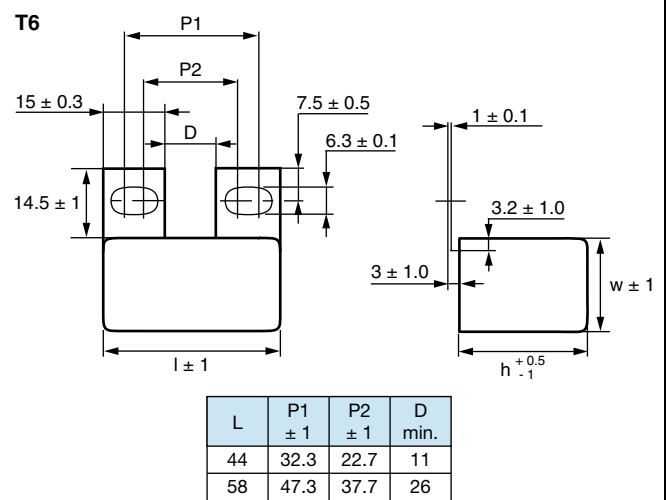
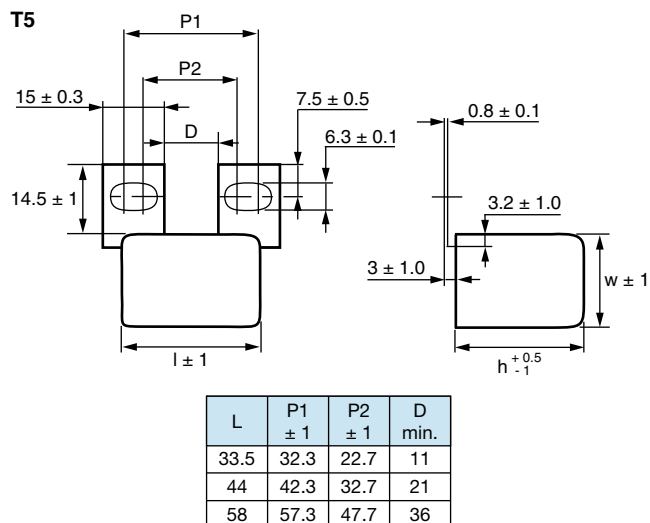
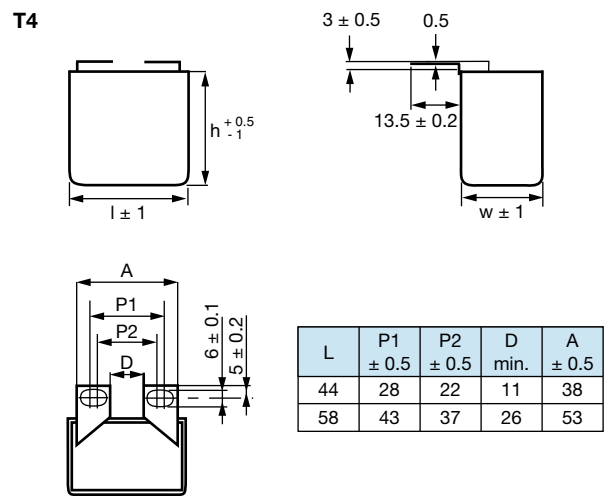
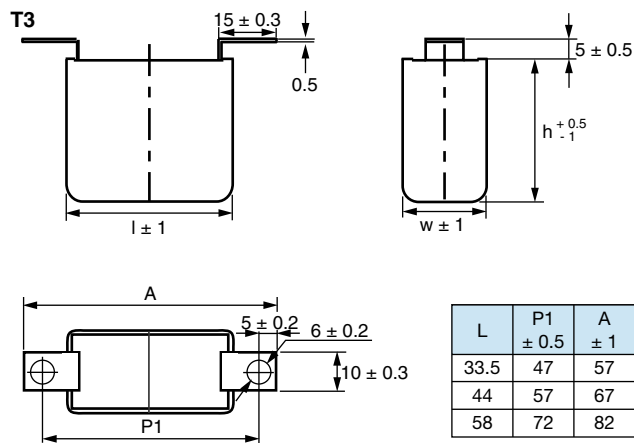
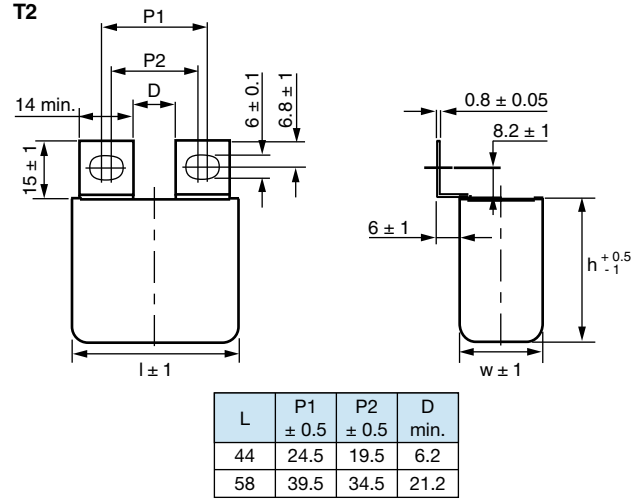
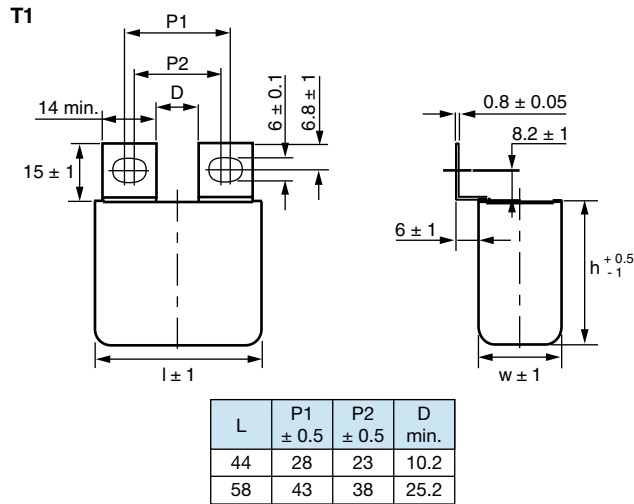
DIMENSIONS in millimeters AND AVAILABLE TERMINAL VERSIONS

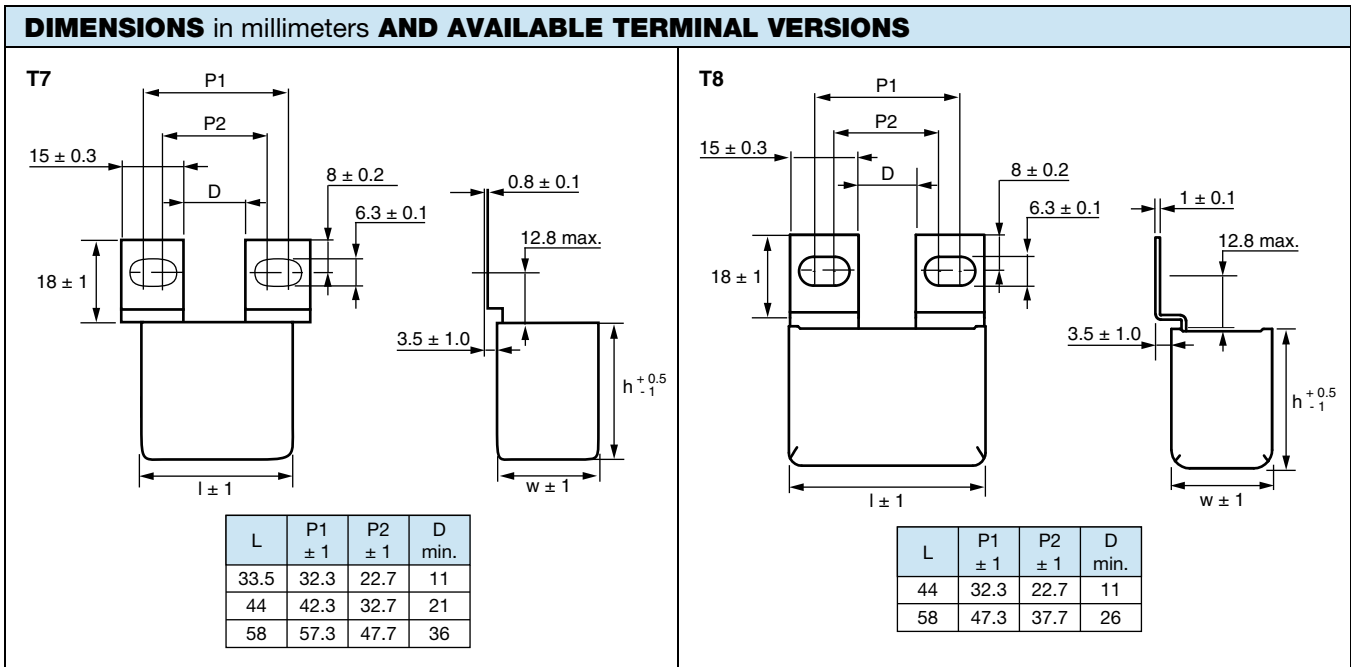

COMPOSITION OF CATALOG NUMBER

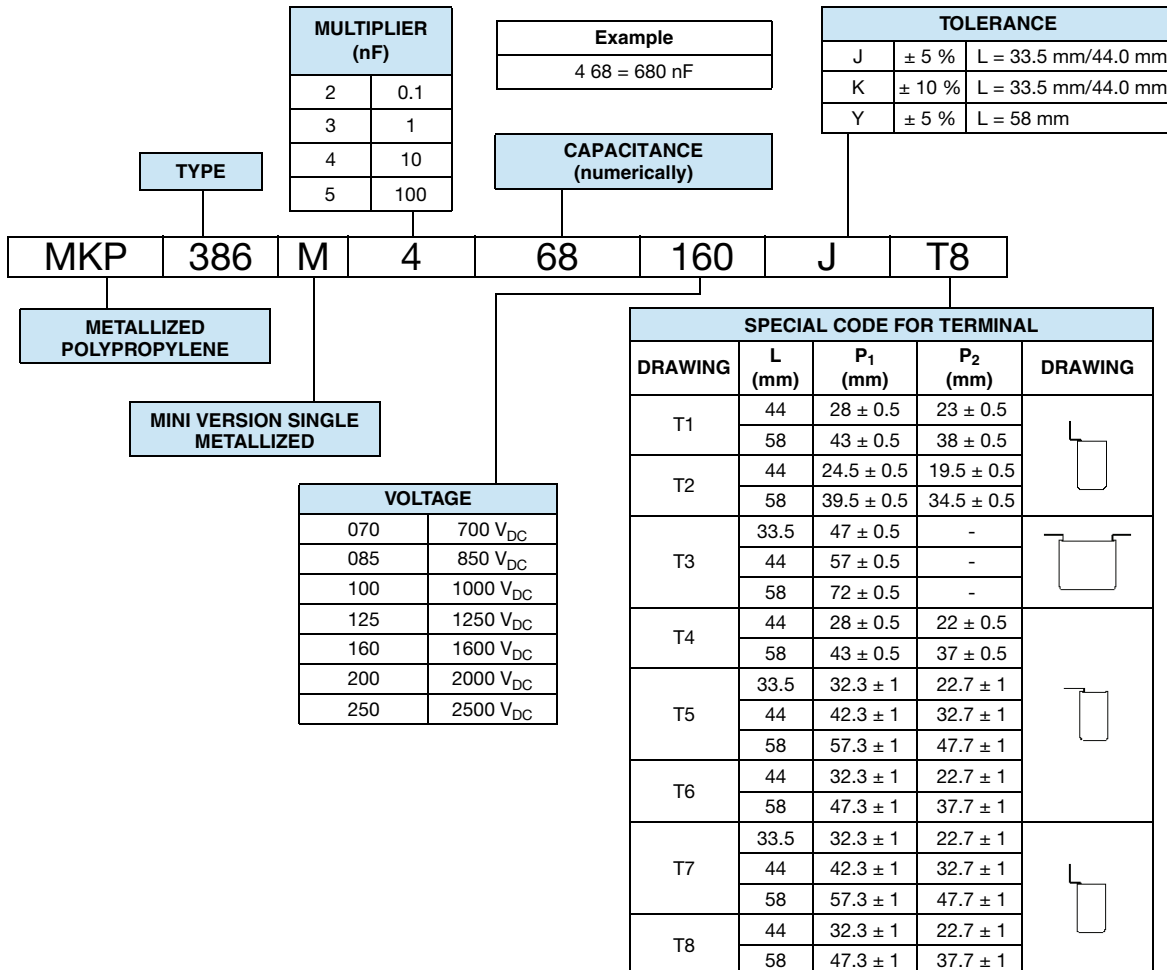



ELECTRICAL DATA AND ORDERING CODE												
U _{RDC} (V)	CAP. (µF)	DIMENSION (mm) ⁽⁴⁾			dU/dt (V/µs)	I _{peak} (A)	I _{RMS} ⁽²⁾ (A)	ESR ⁽³⁾ (mΩ)	tan δ 1 kHz < (10 ⁻⁴)	tan δ 10 kHz < (10 ⁻⁴)	tan δ 100 kHz < (10 ⁻⁴)	ORDERING CODE ⁽¹⁾
		W	H	L								
U_{RAC} = 420 V; U_{pp} = 1130 V												
700	0.47	22.0	30.5	33.5	800	376	7.0	16.0	4.0	8.0	50	MKP386M447070J**
	0.68	22.0	30.5	33.5	800	544	8.0	11.0	4.0	8.0	50	MKP386M468070J**
	1.0	22.0	30.5	33.5	800	800	9.0	7.5	4.0	8.0	50	MKP386M510070J**
	1.5	22.0	30.5	33.5	800	1200	10.0	5.0	4.0	8.0	-	MKP386M515070J**
	2.0	22.0	38.0	44.0	370	740	10.0	7.5	5.0	15.0	-	MKP386M520070J**
	2.2	22.0	38.0	44.0	370	814	10.0	6.5	5.0	15.0	-	MKP386M522070J**
	3.0	30.0	46.0	44.0	370	1110	14.0	5.5	5.0	15.0	-	MKP386M530070J**
	3.3	30.0	46.0	44.0	370	1221	14.0	5.0	5.0	15.0	-	MKP386M533070J**
	4.0	30.0	46.0	44.0	370	1480	15.0	4.5	5.0	15.0	-	MKP386M540070J**
	4.7	30.0	46.0	44.0	370	1739	15.0	6.0	5.0	15.0	-	MKP386M547070J**
5.0	30.0	46.0	44.0	370	1850	15.0	6.0	5.0	15.0	-	MKP386M550070J**	
U_{RAC} = 450 V; U_{pp} = 1300 V												
850	0.47	22.0	30.5	33.5	800	376	7.5	13.0	4.0	8.0	50	MKP386M447085J**
	0.68	22.0	30.5	33.5	800	544	8.5	10.0	4.0	8.0	50	MKP386M468085J**
	0.82	22.0	30.5	33.5	800	656	9.0	8.5	4.0	8.0	50	MKP386M482085J**
	1.0	22.0	30.5	33.5	800	800	10.0	7.0	4.0	8.0	50	MKP386M510085J**
	1.5	22.0	38.0	44.0	370	555	10.0	9.0	5.0	15.0	-	MKP386M515085J**
	2.0	22.0	38.0	44.0	370	740	12.0	7.0	5.0	15.0	-	MKP386M520085J**
	2.2	22.0	38.0	44.0	370	814	13.0	6.0	5.0	15.0	-	MKP386M522085J**
	3.0	30.0	46.0	44.0	370	1110	16.0	4.5	5.0	15.0	-	MKP386M530085J**
	3.3	30.0	46.0	44.0	370	1221	16.0	4.0	5.0	15.0	-	MKP386M533085J**
	4.0	30.0	46.0	44.0	370	1480	18.0	3.5	5.0	15.0	-	MKP386M540085J**
U_{RAC} = 400 V; U_{pp} = 1200 V												
	4.7	25.0	45.0	58.0	170	798	17.5	4.0	6.0	25	-	MKP386M547085Y**
	5.0	25.0	45.0	58.0	170	849	18.0	3.5	6.0	25	-	MKP386M550085Y**
	6.0	30.0	45.0	58.0	170	1019	20.5	3.0	6.0	25	-	MKP386M560085Y**
	7.0	30.0	45.0	58.0	170	1189	22.5	2.5	6.0	25	-	MKP386M570085Y**
	8.0	35.0	50.0	58.0	170	1358	26.0	2.0	6.0	25	-	MKP386M580085Y**
	10	35.0	50.0	58.0	170	1698	29.0	1.5	6.0	25	-	MKP386M610085Y**
	U_{RAC} = 500 V; U_{pp} = 1400 V											
1000	0.47	22.0	30.5	33.5	725	341	7.5	13.0	4.0	8.0	50	MKP386M447100J**
	0.56	22.0	30.5	33.5	725	406	8.0	11.0	4.0	8.0	50	MKP386M456100J**
	0.68	22.0	30.5	33.5	725	493	9.0	9.0	4.0	8.0	50	MKP386M468100J**
	0.82	22.0	30.5	33.5	725	595	9.0	7.5	4.0	8.0	50	MKP386M482100J**
	1.0	22.0	30.5	33.5	725	725	10.0	6.0	4.0	8.0	50	MKP386M510100J**
	1.2	22.0	38.0	44.0	340	408	10.0	10.0	5.0	15.0	-	MKP386M512100J**
	1.5	22.0	38.0	44.0	340	510	11.0	8.0	5.0	15.0	-	MKP386M515100J**
	1.8	22.0	38.0	44.0	340	612	12.0	6.5	5.0	15.0	-	MKP386M518100J**
	2.0	30.0	46.0	44.0	340	680	14.0	6.0	5.0	15.0	-	MKP386M520100J**
	2.2	30.0	46.0	44.0	340	748	15.0	5.5	5.0	15.0	-	MKP386M522100J**
	2.5	30.0	46.0	44.0	340	850	15.0	5.0	5.0	15.0	-	MKP386M525100J**
	2.7	30.0	46.0	44.0	340	918	16.0	4.5	5.0	15.0	-	MKP386M527100J**
	3.3	30.0	46.0	44.0	340	1122	18.0	3.5	5.0	15.0	-	MKP386M533100J**
U_{RAC} = 425 V; U_{pp} = 1200 V												
	3.3	25.0	45.0	58.0	205	677	16.0	4.5	7.5	25	-	MKP386M533100Y**
	4.0	25.0	45.0	58.0	205	820	17.5	3.5	7.5	25	-	MKP386M540100Y**
	4.7	30.0	45.0	58.0	205	964	20.0	3.0	7.5	25	-	MKP386M547100Y**
	5.0	30.0	45.0	58.0	205	1025	21.0	3.0	7.5	25	-	MKP386M550100Y**
	6.0	35.0	50.0	58.0	205	1230	24.5	2.5	7.5	25	-	MKP386M560100Y**
	7.0	35.0	50.0	58.0	205	1435	26.5	2.0	7.5	25	-	MKP386M570100Y**



ELECTRICAL DATA AND ORDERING CODE												
U _{RDC} (V)	CAP. (µF)	DIMENSION (mm) ⁽⁴⁾			dU/dt (V/µs)	I _{peak} (A)	I _{RMS} ⁽²⁾ (A)	ESR ⁽³⁾ (mΩ)	tan δ 1 kHz < (10 ⁻⁴)	tan δ 10 kHz < (10 ⁻⁴)	tan δ 100 kHz < (10 ⁻⁴)	ORDERING CODE ⁽¹⁾
		W	H	L								
1250	U _{RAC} = 550 V; U _{pp} = 1550 V											
	0.33	22.0	30.5	33.5	800	264	7.0	16.0	4.0	8.0	40	MKP386M433125J**
	0.39	22.0	30.5	33.5	800	312	7.0	14.0	4.0	8.0	40	MKP386M439125J**
	0.47	22.0	30.5	33.5	800	376	8.0	11.0	4.0	8.0	40	MKP386M447125J**
	0.56	22.0	30.5	33.5	800	448	8.5	10.0	4.0	8.0	40	MKP386M456125J**
	0.68	22.0	30.5	33.5	800	544	9.5	8.0	4.0	8.0	40	MKP386M468125J**
	0.82	22.0	38.0	44.0	375	308	9.0	13.0	5.0	15.0	60	MKP386M482125J**
	1.0	22.0	38.0	44.0	375	375	10.0	10.0	5.0	15.0	60	MKP386M510125J**
	1.2	22.0	38.0	44.0	375	450	11.0	9.0	5.0	15.0	-	MKP386M512125J**
	1.5	30.0	46.0	44.0	375	563	14.0	7.0	5.0	15.0	-	MKP386M515125J**
	1.8	30.0	46.0	44.0	375	675	15.0	6.0	5.0	15.0	-	MKP386M518125J**
	2.0	30.0	46.0	44.0	375	750	16.0	5.5	5.0	15.0	-	MKP386M520125J**
	2.2	30.0	46.0	44.0	375	825	18.0	4.5	5.0	15.0	-	MKP386M522125J**
	U _{RAC} = 450 V; U _{pp} = 1300 V											
	2.2	25.0	45.0	58.0	225	495	14.0	6.0	7.5	20	-	MKP386M522125Y**
	2.5	25.0	45.0	58.0	225	563	15.0	5.0	7.5	20	-	MKP386M525125Y**
	3.0	25.0	45.0	58.0	225	675	16.5	4.0	7.5	20	-	MKP386M530125Y**
	3.3	30.0	45.0	58.0	225	743	18.0	4.0	7.5	20	-	MKP386M533125Y**
	4.0	35.0	50.0	58.0	225	900	21.5	3.0	7.5	20	-	MKP386M540125Y**
	4.7	35.0	50.0	58.0	225	1058	23.5	2.5	7.5	20	-	MKP386M547125Y**
5.0	35.0	50.0	58.0	225	1125	24.5	2.5	7.5	20	-	MKP386M550125Y**	
1600	U _{RAC} = 600 V; U _{pp} = 1690 V											
	0.22	22.0	30.5	33.5	800	176	7.0	16.0	3.0	5.0	40	MKP386M422160J**
	0.27	22.0	30.5	33.5	800	216	7.0	15.0	3.0	5.0	40	MKP386M427160J**
	0.33	22.0	30.5	33.5	800	264	8.0	12.0	3.0	5.0	40	MKP386M433160J**
	0.39	22.0	30.5	33.5	800	312	8.5	10.0	3.0	5.0	40	MKP386M439160J**
	0.47	22.0	30.5	33.5	800	376	9.0	8.5	3.0	5.0	40	MKP386M447160J**
	0.56	22.0	38.0	44.0	375	210	9.0	14.0	4.0	10.0	60	MKP386M456160J**
	0.68	22.0	38.0	44.0	375	255	9.0	12.0	4.0	10.0	60	MKP386M468160J**
	0.82	22.0	38.0	44.0	375	308	10.0	10.0	4.0	10.0	60	MKP386M482160J**
	1.0	22.0	38.0	44.0	375	375	12.0	8.0	4.0	10.0	60	MKP386M510160J**
	1.3	30.0	46.0	44.0	375	488	16.0	6.0	4.0	10.0	-	MKP386M513160J**
	1.5	30.0	46.0	44.0	375	563	16.0	5.5	4.0	10.0	-	MKP386M515160J**
	1.8	30.0	46.0	44.0	375	675	18.0	4.5	4.0	10.0	-	MKP386M518160J**
	2.0	30.0	46.0	44.0	375	750	19.0	4.0	4.0	10.0	-	MKP386M520160K**
	U _{RAC} = 450 V; U _{pp} = 1300 V											
	1.5	25.0	45.0	58.0	360	540	18.0	3.5	5.0	15	-	MKP386M515160Y**
2.0	30.0	45.0	58.0	360	720	22.0	2.5	5.0	15	-	MKP386M520160Y**	
2.2	35.0	50.0	58.0	360	792	25.0	2.5	5.0	15	-	MKP386M522160Y**	
2.5	35.0	50.0	58.0	360	900	26.5	2.0	5.0	15	-	MKP386M525160Y**	
2000	U _{RAC} = 700 V; U _{pp} = 1980 V											
	0.047	22.0	30.5	33.5	2000	94	6.0	20.0	3.0	5.0	30	MKP386M347200J**
	0.068	22.0	30.5	33.5	2000	136	6.5	17.0	3.0	5.0	30	MKP386M368200J**
	0.10	22.0	30.5	33.5	2000	200	8.0	11.0	3.0	5.0	30	MKP386M410200J**
	0.12	22.0	30.5	33.5	2000	240	9.0	9.0	3.0	5.0	30	MKP386M412200J**
	0.15	22.0	30.5	33.5	2000	300	9.5	8.0	3.0	5.0	30	MKP386M415200J**
	0.22	22.0	38.0	44.0	850	187	10.0	10.0	4.0	10.0	50	MKP386M422200J**
	0.27	22.0	38.0	44.0	850	230	11.0	8.5	4.0	10.0	50	MKP386M427200J**
	0.33	22.0	38.0	44.0	850	281	12.0	7.0	4.0	10.0	50	MKP386M433200J**
	0.39	22.0	38.0	44.0	850	332	12.0	6.0	4.0	10.0	50	MKP386M439200J**
	0.47	30.0	46.0	44.0	850	400	16.0	5.0	4.0	10.0	50	MKP386M447200J**
	0.56	30.0	46.0	44.0	850	476	18.0	4.0	4.0	10.0	50	MKP386M456200J**
	0.68	30.0	46.0	44.0	850	578	20.0	3.5	4.0	10.0	50	MKP386M468200J**
	0.68	25.0	45.0	58.0	525	357	14.0	6.0	5.0	15.0	75	MKP386M468200Y**
0.82	25.0	45.0	58.0	525	431	15.5	5.0	5.0	15.0	75	MKP386M482200Y**	
1.0	30.0	45.0	58.0	525	525	18.0	4.0	5.0	15.0	-	MKP386M510200Y**	
1.5	35.0	50.0	58.0	525	788	24.0	2.5	5.0	15.0	-	MKP386M515200Y**	



ELECTRICAL DATA AND ORDERING CODE												
U _{RDC} (V)	CAP. (μF)	DIMENSION (mm) ⁽⁴⁾			dU/dt (V/μs)	I _{peak} (A)	I _{RMS} ⁽²⁾ (A)	ESR ⁽³⁾ (mΩ)	tan δ 1 kHz < (10 ⁻⁴)	tan δ 10 kHz < (10 ⁻⁴)	tan δ 100 kHz < (10 ⁻⁴)	ORDERING CODE ⁽¹⁾
		W	H	L								
U _{RAC} = 800 V; U _{pp} = 2260 V												
2500	0.047	22.0	30.5	33.5	2500	118	6.0	20.0	3.0	5.0	30	MKP386M347250J**
	0.068	22.0	30.5	33.5	2500	170	7.0	14.0	3.0	5.0	30	MKP386M368250J**
	0.10	22.0	30.5	33.5	2500	250	8.5	10.0	3.0	5.0	30	MKP386M410250J**
	0.12	22.0	30.5	33.5	2500	300	9.5	8.0	3.0	5.0	30	MKP386M412250J**
	0.15	22.0	38.0	44.0	1000	150	9.5	12.5	4.0	10.0	50	MKP386M415250J**
	0.18	22.0	38.0	44.0	1000	180	10.0	11.0	4.0	10.0	50	MKP386M418250J**
	0.22	22.0	38.0	44.0	1000	220	11.0	8.5	4.0	10.0	50	MKP386M422250J**
	0.33	30.0	46.0	44.0	1000	330	15.0	6.0	4.0	10.0	50	MKP386M433250J**
	0.39	30.0	46.0	44.0	1000	390	16.0	5.0	4.0	10.0	50	MKP386M439250J**
	0.47	30.0	46.0	44.0	1000	470	18.0	4.0	4.0	10.0	50	MKP386M447250J**
	0.47	25.0	45.0	58.0	795	374	15.0	5.5	5.0	15.0	75	MKP386M447250Y**
	0.56	30.0	45.0	58.0	795	445	17.0	4.5	5.0	15.0	75	MKP386M456250Y**
0.68	35.0	50.0	58.0	795	541	20.5	4.0	5.0	15.0	75	MKP386M468250Y**	
0.82	35.0	50.0	58.0	795	652	22.5	3.0	5.0	15.0	75	MKP386M482250Y**	

Notes

- (1) Change the symbol ** according special code for the terminals (see Packaging Information table)
- (2) Maximum RMS current at 100 kHz, + 85 °C
- (3) The ESR (Equivalent Series Resistance) typical values at 100 kHz
- (4) Standard dimension

PACKAGING INFORMATION											
U _{RDC} (V)	CAP. (μF)	ORDERING CODE ⁽¹⁾	MASS (g)	TERMINAL AVAILABLE - SPQ (pcs)							
				T1	T2	T3	T4	T5	T6	T7	T8
700	0.47	MKP386M447070J**	41			48		48		55	
	0.68	MKP386M468070J**	39			48		48		55	
	1.0	MKP386M510070J**	38			48		48		55	
	1.5	MKP386M515070J**	35			48		48		55	
	2.0	MKP386M520070J**	59	42	42	36	42	36	42	36	42
	2.2	MKP386M522070J**	57	42	42	36	42	36	42	36	42
	3.0	MKP386M530070J**	91	63	63	54	63	60	63	60	63
	3.3	MKP386M533070J**	89	63	63	54	63	60	63	60	63
	4.0	MKP386M540070J**	86	63	63	54	63	60	63	60	63
	4.7	MKP386M547070J**	82	63	63	54	63	60	63	60	63
850	5.0	MKP386M550070J**	80	63	63	54	63	60	63	60	63
	0.47	MKP386M447085J**	40			48		48		55	
	0.68	MKP386M468085J**	39			48		48		55	
	0.82	MKP386M482085J**	38			48		48		55	
	1.0	MKP386M510085J**	36			48		48		55	
	1.5	MKP386M515085J**	60	42	42	36	42	36	42	36	42
	2.0	MKP386M520085J**	56	42	42	36	42	36	42	36	42
	2.2	MKP386M522085J**	55	42	42	36	42	36	42	36	42
	3.0	MKP386M530085J**	88	63	63	54	63	60	63	60	63
	3.3	MKP386M533085J**	86	63	63	54	63	60	63	60	63
	4.0	MKP386M540085J**	86	63	63	54	63	60	63	60	63
	4.7	MKP386M547085Y**	79	50	50	48	55	55	55	50	50
	5.0	MKP386M550085Y**	78	50	50	48	55	55	55	50	50
	6.0	MKP386M560085Y**	93	45	45	40	45	45	45	45	45
	7.0	MKP386M570085Y**	90	45	45	40	45	45	45	45	45
8.0	MKP386M580085Y**	121	35	35	36	40	40	40	35	35	
10	MKP386M610085Y**	114	35	35	36	40	40	40	35	35	



PACKAGING INFORMATION											
U _{RDC} (V)	CAP. (µF)	ORDERING CODE (1)	MASS (g)	TERMINAL AVAILABLE - SPQ (pcs)							
				T1	T2	T3	T4	T5	T6	T7	T8
1000	0.47	MKP386M447100J**	39			48		48		55	
	0.56	MKP386M456100J**	39			48		48		55	
	0.68	MKP386M468100J**	38			48		48		55	
	0.82	MKP386M482100J**	37			48		48		55	
	1.0	MKP386M510100J**	35			48		48		55	
	1.2	MKP386M512100J**	60	42	42	36	42	36	42	36	42
	1.5	MKP386M515100J**	58	42	42	36	42	36	42	36	42
	1.8	MKP386M518100J**	56	42	42	36	42	36	42	36	42
	2.0	MKP386M520100J**	92	63	63	54	63	60	63	60	63
	2.2	MKP386M522100J**	90	63	63	54	63	60	63	60	63
	2.5	MKP386M525100J**	88	63	63	54	63	60	63	60	63
	2.7	MKP386M527100J**	86	63	63	54	63	60	63	60	63
	3.3	MKP386M533100J**	81	63	63	54	63	60	63	60	63
	3.3	MKP386M533100Y**	78	50	50	48	55	55	55	50	50
	4.0	MKP386M540100Y**	75	50	50	48	55	55	55	50	50
	4.7	MKP386M547100Y**	90	45	45	40	45	45	45	45	45
5.0	MKP386M550100Y**	89	45	45	40	45	45	45	45	45	
6.0	MKP386M560100Y**	119	35	35	36	40	40	40	35	35	
7.0	MKP386M570100Y**	114	35	35	36	40	40	40	35	35	
1250	0.33	MKP386M433125J**	40			48		48		55	
	0.39	MKP386M439125J**	39			48		48		55	
	0.47	MKP386M447125J**	38			48		48		55	
	0.56	MKP386M456125J**	37			48		48		55	
	0.68	MKP386M468125J**	36			48		48		55	
	0.82	MKP386M482125J**	60	42	42	36	42	36	42	36	42
	1.0	MKP386M510125J**	59	42	42	36	42	36	42	36	42
	1.2	MKP386M512125J**	56	42	42	36	42	36	42	36	42
	1.5	MKP386M515125J**	91	63	63	54	63	60	63	60	63
	1.8	MKP386M518125J**	88	63	63	54	63	60	63	60	63
	2.0	MKP386M520125J**	86	63	63	54	63	60	63	60	63
	2.2	MKP386M522125J**	84	63	63	54	63	60	63	60	63
	2.2	MKP386M522125Y**	81	50	50	48	55	55	55	50	50
	2.5	MKP386M525125Y**	79	50	50	48	55	55	55	50	50
	3.0	MKP386M530125Y**	76	50	50	48	55	55	55	50	50
	3.3	MKP386M533125Y**	93	45	45	40	45	45	45	45	45
4.0	MKP386M540125Y**	123	35	35	36	40	40	40	35	35	
4.7	MKP386M547125Y**	119	35	35	36	40	40	40	35	35	
5.0	MKP386M550125Y**	116	35	35	36	40	40	40	35	35	
1600	0.22	MKP386M422160J**	40			48		48		55	
	0.27	MKP386M427160J**	39			48		48		55	
	0.33	MKP386M433160J**	38			48		48		55	
	0.39	MKP386M439160J**	37			48		48		55	
	0.47	MKP386M447160J**	35			48		48		55	
	0.56	MKP386M456160J**	61	42	42	36	42	36	42	36	42
	0.68	MKP386M468160J**	59	42	42	36	42	36	42	36	42
	0.82	MKP386M482160J**	57	42	42	36	42	36	42	36	42
	1.0	MKP386M510160J**	54	42	42	36	42	36	42	36	42
	1.3	MKP386M513160J**	87	63	63	54	63	60	63	60	63
	1.5	MKP386M515160J**	84	63	63	54	63	60	63	60	63
	1.8	MKP386M518160J**	79	63	63	54	63	60	63	60	63
	2.0	MKP386M520160K**	76	63	63	54	63	60	63	60	63
	1.5	MKP386M515160Y**	75	50	50	48	55	55	55	50	50
	2.0	MKP386M520160Y**	87	45	45	40	45	45	45	45	45
	2.2	MKP386M522160Y**	119	35	35	36	40	40	40	35	35
2.5	MKP386M525160Y**	115	35	35	36	40	40	40	35	35	

PACKAGING INFORMATION											
U _{RDC} (V)	CAP. (μF)	ORDERING CODE (1)	MASS (g)	TERMINAL AVAILABLE - SPQ (pcs)							
				T1	T2	T3	T4	T5	T6	T7	T8
2000	0.047	MKP386M347200J**	41			48		48		55	
	0.068	MKP386M368200J**	40			48		48		55	
	0.10	MKP386M410200J**	39			48		48		55	
	0.12	MKP386M412200J**	38			48		48		55	
	0.15	MKP386M415200J**	37			48		48		55	
	0.22	MKP386M422200J**	61	42	42	36	42	36	42	36	42
	0.27	MKP386M427200J**	59	42	42	36	42	36	42	36	42
	0.33	MKP386M433200J**	57	42	42	36	42	36	42	36	42
	0.39	MKP386M439200J**	55	42	42	36	42	36	42	36	42
	0.47	MKP386M447200J**	90	63	63	54	63	60	63	60	63
	0.56	MKP386M456200J**	87	63	63	54	63	60	63	60	63
	0.68	MKP386M468200J**	82	63	63	54	63	60	63	60	63
	0.68	MKP386M468200Y**	78	50	50	48	55	55	55	50	50
	0.82	MKP386M482200Y**	75	50	50	48	55	55	55	50	50
1.0	MKP386M510200Y**	89	45	45	40	45	45	45	45	45	
1.5	MKP386M515200Y**	112	35	35	36	40	40	40	35	35	
2500	0.047	MKP386M347250J**	40			48		48		55	
	0.068	MKP386M368250J**	39			48		48		55	
	0.10	MKP386M410250J**	37			48		48		55	
	0.12	MKP386M412250J**	36			48		48		55	
	0.15	MKP386M415250J**	61	42	42	36	42	36	42	36	42
	0.18	MKP386M418250J**	59	42	42	36	42	36	42	36	42
	0.22	MKP386M422250J**	57	42	42	36	42	36	42	36	42
	0.33	MKP386M433250J**	88	63	63	54	63	60	63	60	63
	0.39	MKP386M439250J**	85	63	63	54	63	60	63	60	63
	0.47	MKP386M447250J**	80	63	63	54	63	60	63	60	63
	0.47	MKP386M447250Y**	74	50	50	48	55	55	55	50	50
	0.56	MKP386M456250Y**	89	45	45	40	45	45	45	45	45
	0.68	MKP386M468250Y**	119	35	35	36	40	40	40	35	35
	0.82	MKP386M482250Y**	113	35	35	36	40	40	40	35	35

Note

(1) Change the ** symbol according special code for the terminals

CONSTRUCTION

Low inductive wound cells elements of metallized polypropylene film, potted with resin in flame retardant case. Series construction for 420 V_{AC} to 600 V_{AC} versions build in case width ≤ 44 mm and 450 V_{AC} to 550 V_{AC} versions build in case width > 44 mm.

Triple construction for 700 V_{AC} and 800 V_{AC} versions build in case width ≤ 44 mm and 550 V_{AC} to 700 V_{AC} versions build in case width > 44 mm.

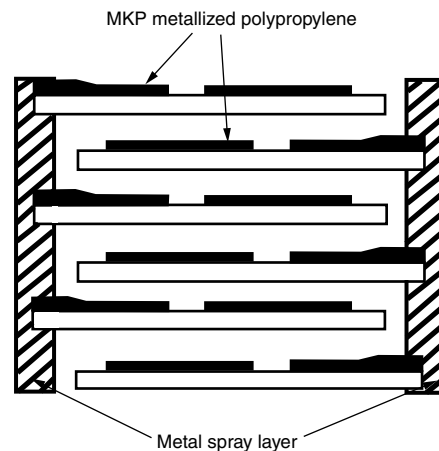
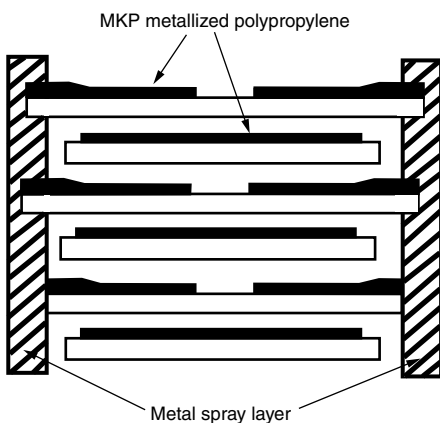

Series construction with 4 sections for 800 V_{AC} versions build in case width > 44 mm.



MOUNTING

Normal Use

The capacitors are designed for mounting on printed-circuit boards or IGBT or GTO modules.

Specific Method of Mounting to Withstand Vibration and Shock

In order to withstand vibration and shock tests, the capacitors shall be mechanically fixed by tabs it must be ensured that the tabs are screwed tightly on the test board.

When the weight of the capacitor is bigger than 50 g it needs a clamp in the body of the capacitor.

SOLDERING CONDITIONS

Storage Temperature

$T_{stg} = -25\text{ }^{\circ}\text{C}$ to $+35\text{ }^{\circ}\text{C}$ with RH maximum 75 % without condensation.

Ratings and Characteristics Reference Conditions

Unless otherwise specified, all electrical values apply to an ambient temperature of $23\text{ }^{\circ}\text{C} \pm 1\text{ }^{\circ}\text{C}$, an atmospheric pressure of 86 kPa to 106 kPa and a relative humidity of $50\% \pm 2\%$.

For reference testing, a conditioning period shall be applied over $96\text{ h} \pm 4\text{ h}$ by heating the products in a circulating air oven at the rated temperature and a relative humidity not exceeding 20 %.

CHARACTERISTICS

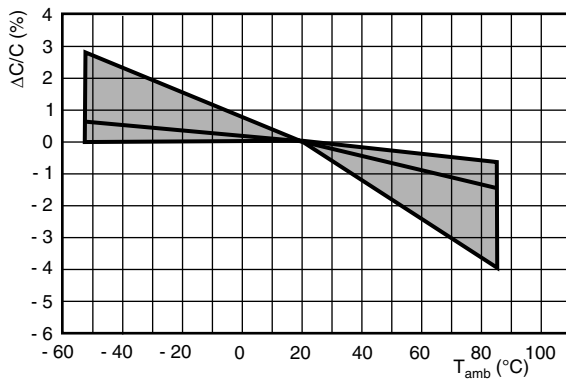

Capacitance as a function of ambient temperature (typical curve)

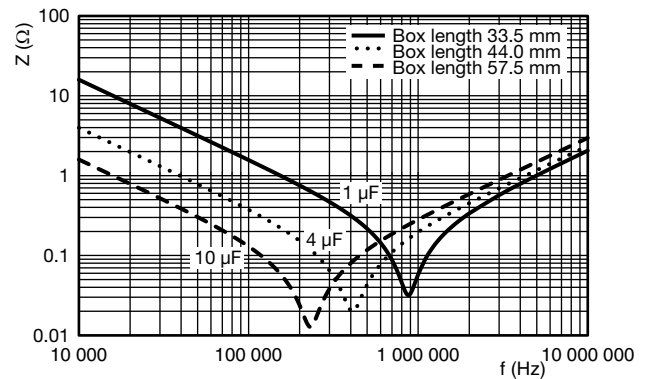

Impedance as a function of frequency (typical curve)

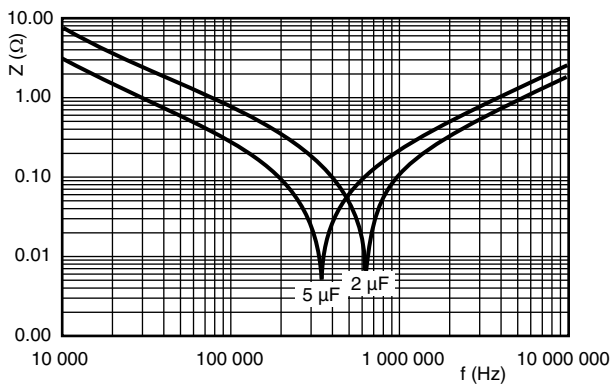

Impedance as function of frequency for box length 44.0 mm (typical curve)

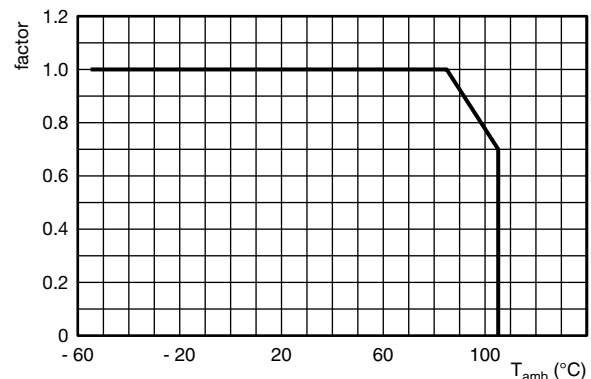

Max. DC and AC voltage as a function of temperature



CHARACTERISTICS

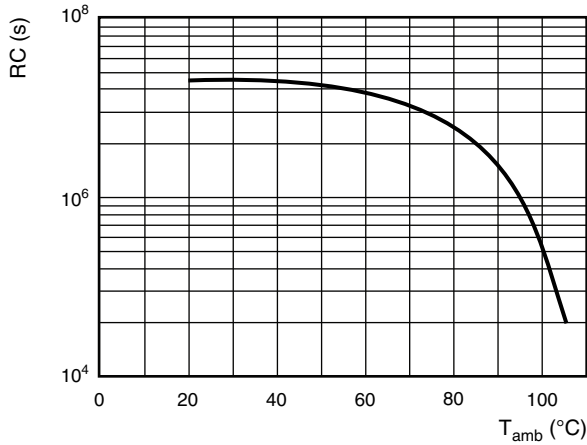

Insulation resistance as a function of ambient temperature (typical curve)

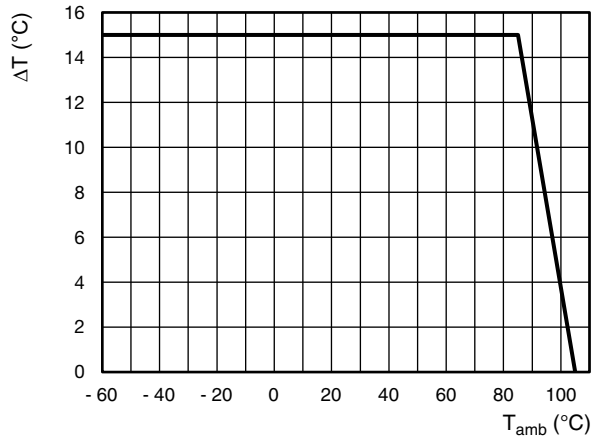

Maximum allowed component temperature rise (ΔT) as function of the ambient temperature (T_{amb})

MAXIMUM RMS VOLTAGE (SINEWAVE) AS A FUNCTION OF FREQUENCY

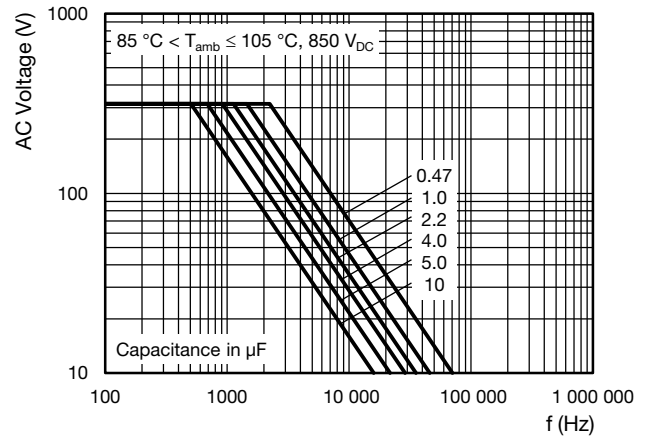
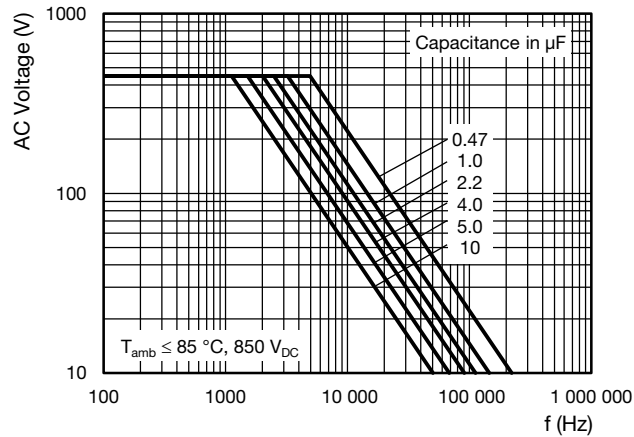
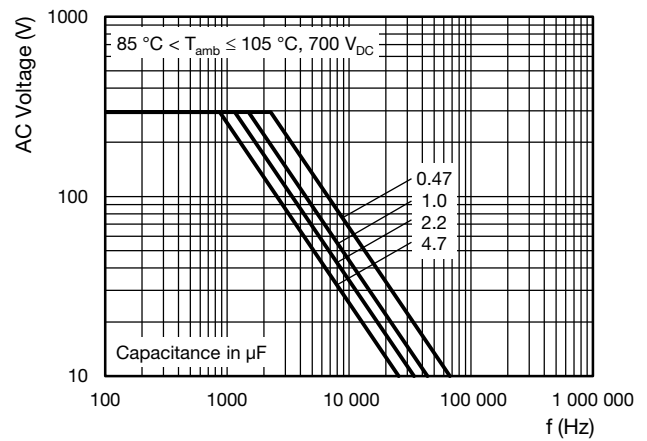
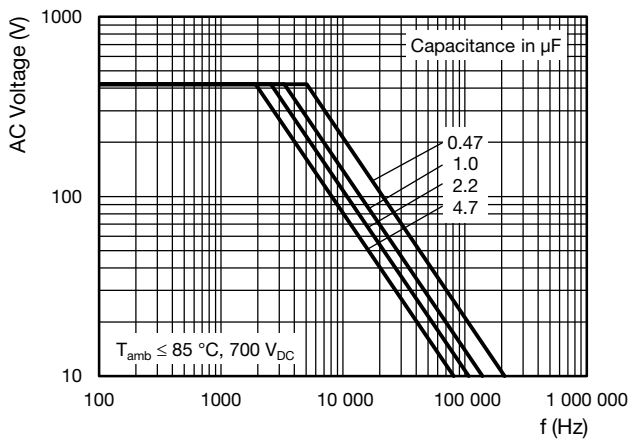



MAXIMUM RMS VOLTAGE (SINEWAVE) AS A FUNCTION OF FREQUENCY

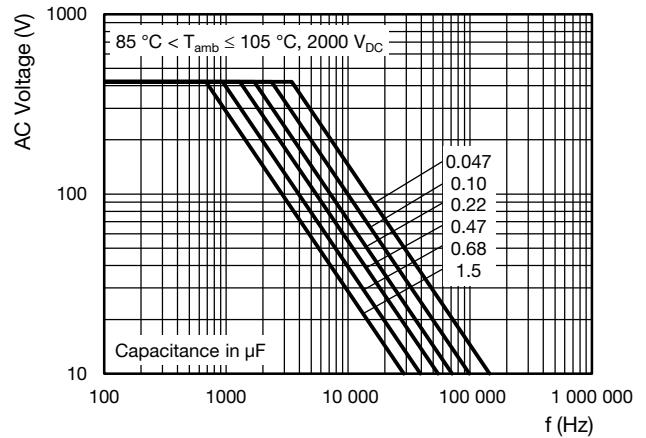
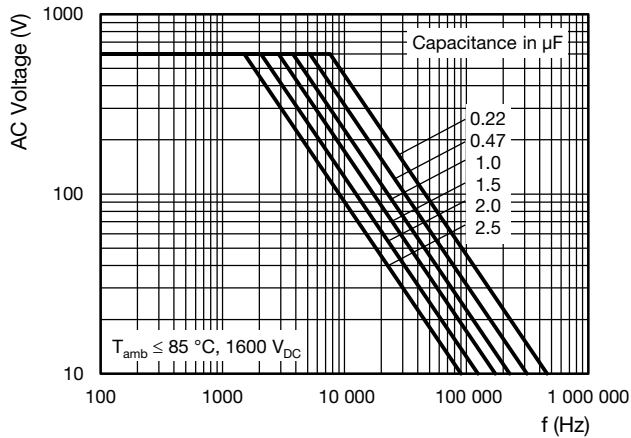
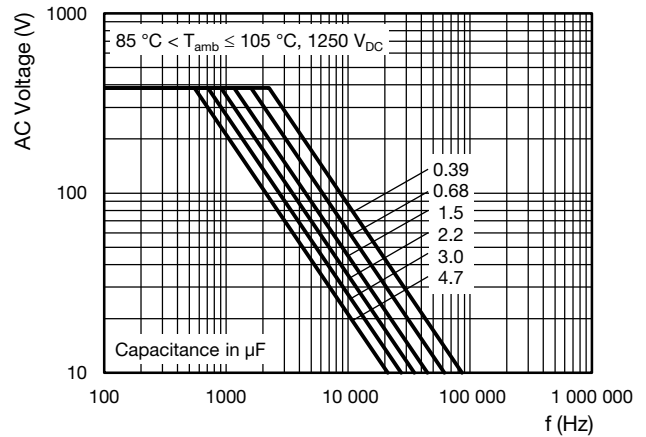
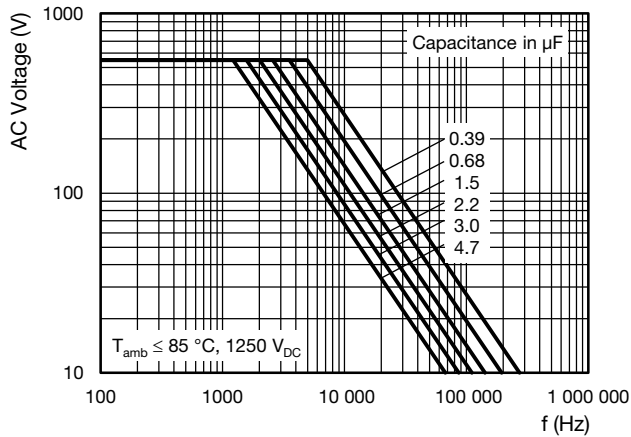
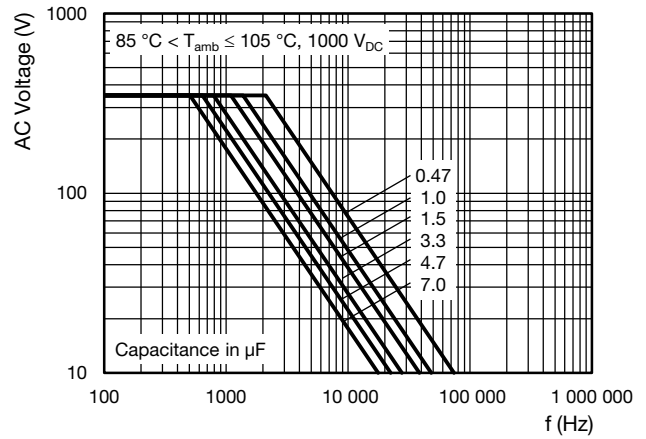
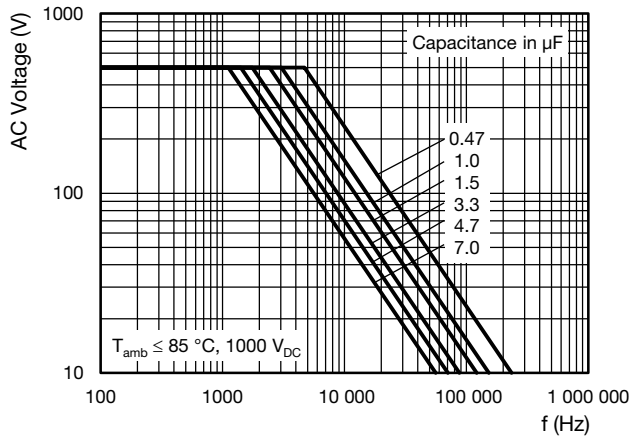



MAXIMUM RMS VOLTAGE (SINEWAVE) AS A FUNCTION OF FREQUENCY

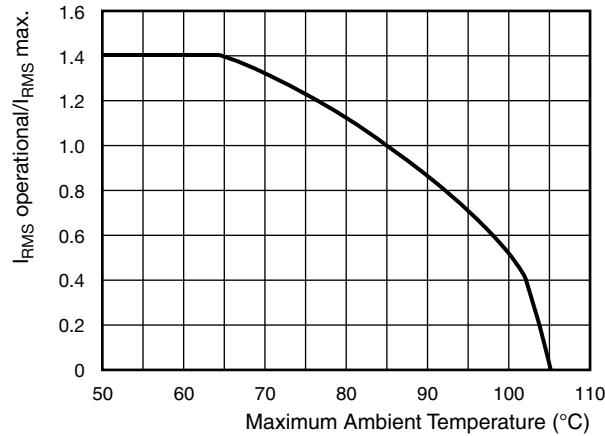
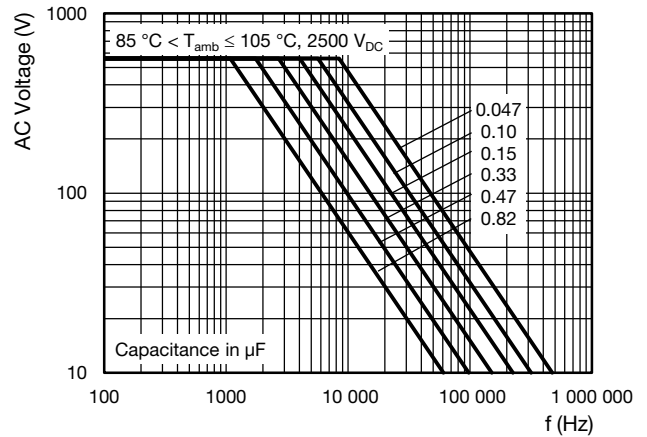
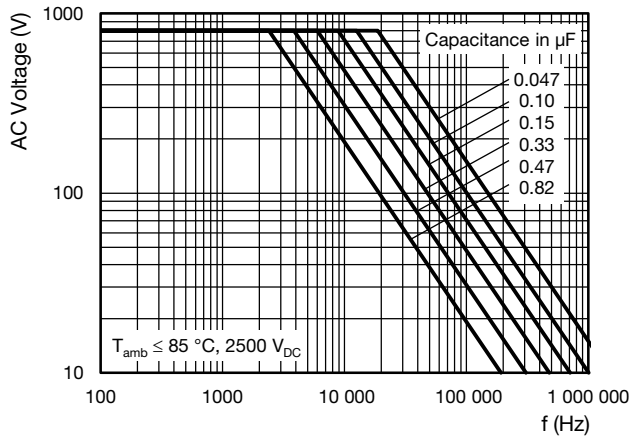
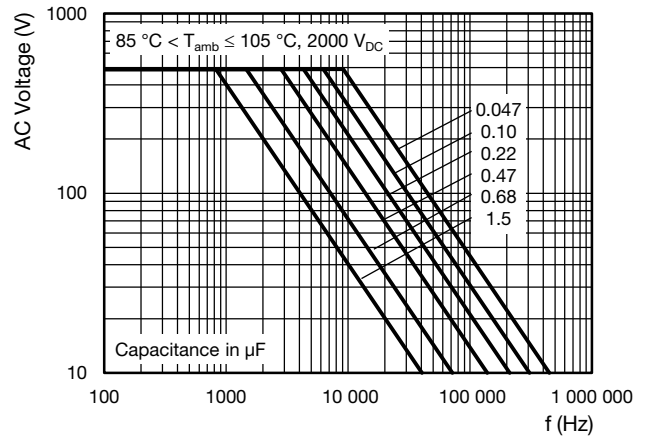
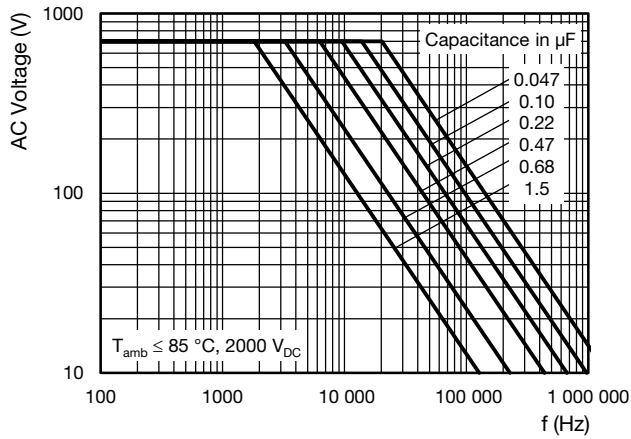

Maximum I_{RMS} current in function of the ambient temperature



MARKING

Product Marking and Identification

The capacitor is marked by laser print or stamp, with following information:

1. Manufacturer's logo
2. Code for dielectric material (MKP)
3. Manufacturer's type designation (386)
4. Single metallized (M)
5. Rated capacitance value (5 μ F)
6. Tolerance on rated capacitance (J = \pm 5 %)
7. Rated DC voltage (700 V)
8. Code for factory of origin (F)
9. Year and week of manufacture (e.g. 0825)

Printing Example:

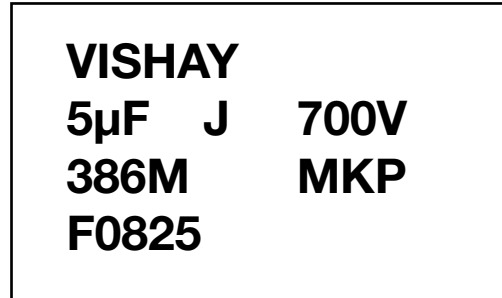

Packing Bar Code Label

1. Manufacturer's logo
2. Country of origin
3. Sub family
4. Type description
5. Capacitance value, tolerance, voltage and climatic category according to IEC 60068-1
6. Production center
7. Preference origin code: A
Country of origin in code
8. Product type description
9. Batch number
10. Quantity and production date, year week code
11. Product code

Label Example:

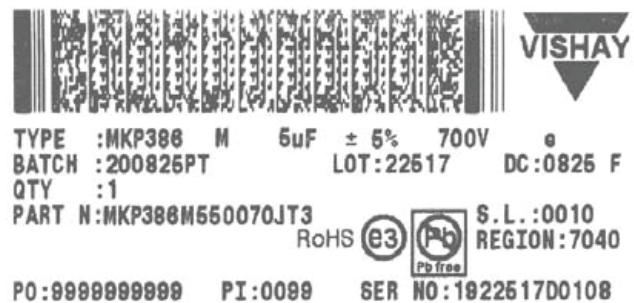

HEAT CONDUCTIVITY (G) AS A FUNCTION OF ORIGINAL PITCH AND CAPACITOR BODY THICKNESS IN mW/°C			
W _{max.} (mm)	HEAT CONDUCTIVITY (mW/°C)		
	BOX LENGTH 33.5 mm	BOX LENGTH 44.0 mm	BOX LENGTH 58.0 mm
22	75	100	-
25	-	-	155
30	-	140	170
35	-	-	200

POWER DISSIPATION AND MAXIMUM COMPONENT TEMPERATURE RISE

The power dissipation must be limited in order not to exceed the maximum allowed component temperature rise as a function of the free air ambient temperature.

The power dissipation can be calculated according type detail specification "HQN-384-01/101: Technical Information Film Capacitors" with the typical tgδ of the curves.

The component temperature rise (ΔT) can be measured (see section "Measuring the Component Temperature" for more details) or calculated by $\Delta T = P/G$:

- ΔT = Component temperature rise (°C) with maximum of 10 °C rise (°C)
- P = Power dissipation of the component (mW)
- G = Heat conductivity of the component (mW/°C)

MEASURING THE COMPONENT TEMPERATURE

A thermocouple must be attached to the capacitor body as in:

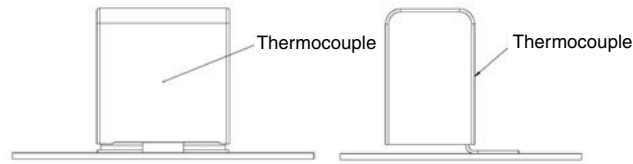

The temperature is measured in unloaded (T_{amb}) and maximum loaded condition (T_C).

The temperature rise is given by $\Delta T = T_C - T_{amb}$.

To avoid radiation or convection, the capacitor should be tested in a wind-free box.

APPLICATION NOTE AND LIMITING CONDITIONS

These capacitors are not suitable for mains applications as across-the-line capacitors without additional protection, as described hereunder. These mains applications are strictly regulated in safety standards and therefore electromagnetic interference suppression capacitors conforming the standards must be used.

To select the capacitor for a certain application, the following conditions must be checked:

1. The peak voltage (U_p) shall not be greater than the rated DC voltage (U_{RDC})
2. The peak-to-peak voltage (U_{pp}) shall not be greater than the maximum (U_{pp}) to avoid the ionization inception level
3. The voltage peak slope (dU/dt) shall not exceed the rated voltage pulse slope in an RC-circuit at rated voltage and without ringing. If the pulse voltage is lower than the rated DC voltage, the rated voltage pulse slope may be multiplied by U_{RDC} and divided by the applied voltage.

For all other pulses following equation must be fulfilled:

$$2 \times \int_0^T \left(\frac{dU}{dt} \right)^2 \times dt < U_{RDC} \times \left(\frac{dU}{dt} \right)_{rated}$$

T is the pulse duration.

4. The maximum component surface temperature rise must be lower than the limits (see figure Max. Allowed Component Temperature Rise)
5. Since in circuits used at voltages over 280 V peak-to-peak the risk for an intrinsically active flammability after a capacitor breakdown (short circuit) increases, it is recommended that the power to the component is limited to 100 times the values mentioned in the table "Heat conductivity"
6. When using these capacitors as across-the-line capacitor in the input filter for mains applications or as series connected with an impedance to the mains the applicant must guarantee that the following conditions are fulfilled in any case (spikes and surge voltages from the mains included)

VOLTAGE CONDITIONS FOR 6 ABOVE		
ALLOWED VOLTAGES	$T_{amb} \leq 85 \text{ }^\circ\text{C}$	$85 \text{ }^\circ\text{C} \leq T_{amb} \leq 105 \text{ }^\circ\text{C}$
Maximum continuous RMS voltage	U_{RAC}	$0.7 \times U_{RAC}$
Maximum temporary RMS overvoltage (< 24 h)	$1.25 \times U_{RAC}$	$0.875 \times U_{RAC}$
Maximum peak voltage (V_{o-p}) (< 2 s)	$1.6 \times U_{RDC}$	$1.1 \times U_{RDC}$



INSPECTION REQUIREMENTS

General Notes

Sub-clause numbers of tests and performance requirements refer to the “Sectional Specification, Publication IEC 60384-17”.

GROUP C INSPECTION REQUIREMENTS		
SUB-CLAUSE NUMBER AND TEST	CONDITIONS	PERFORMANCE REQUIREMENTS
SUB-GROUP C1A PART OF SAMPLE OF SUB-GROUP C1		
4.1 Dimensions (details)		As specified in chapters “General Data” of this specification
4.3.1 Initial measurements	Capacitance Tangent of loss angle: For C > 1 µF at 1 kHz For C ≤ 1 µF at 10 kHz	
4.3 Robustness of terminations	Tensile: Load 30 N; 10 s	No visible damage
4.4 Resistance to soldering heat	No pre-drying Method: 1A Solder bath: 265 °C Duration: 10 s	
4.4.2 Final measurements	Visual examination	No visible damage Legible marking
	Capacitance	$ \Delta C/C \leq 2\%$ of the value measured initially
	Tangent of loss angle	Increase of $\tan \delta: \leq 0.002$ Compared to values measured initially
	Insulation resistance	$\leq 50\%$ values specified in section “Insulation Resistance” of this specification
SUB-GROUP C1B PART OF SAMPLE OF SUB-GROUP C1		
4.6.1 Initial measurements	Capacitance Tangent of loss angle: For C > 1 µF at 1 kHz For C ≤ 1 µF at 10 kHz	
4.6 Rapid change of temperature	$\theta A = -55\text{ °C}$ $\theta B = +105\text{ °C}$ 5 cycles Duration t = 30 min Visual examination	No visible damage
4.7 Vibration	Mounting: See section “Mounting” of this specification Procedure B4: Frequency range: 10 Hz to 55 Hz Amplitude: 0.75 mm or Acceleration 98 m/s ² (whichever is less severe) Total duration 6 h	
4.7.2 Final inspection	Visual examination	No visible damage
4.9 Shock	Mounting: See section “Mounting” for more information Pulse shape: Half sine Acceleration: 490 m/s ² Duration of pulse: 11 ms Visual examination	No visible damage



GROUP C INSPECTION REQUIREMENTS		
SUB-CLAUSE NUMBER AND TEST	CONDITIONS	PERFORMANCE REQUIREMENTS
SUB-GROUP C1B PART OF SAMPLE OF SUB-GROUP C1		
4.9.3 Final measurements	Capacitance Tangent of loss angle Insulation resistance	$ \Delta C/C \leq 2\%$ of the value measured initially Increase of $\tan \delta \leq 0.002$ Compared to values measured initially $\geq 50\%$ values specified in section "Insulation Resistance" of this specification
4.15 Solvent resistance of the marking	Isopropyl alcohol at room temperature Method: 1 Rubbing material: Cotton wool Immersion time: 5 min \pm 0.5 min	No visible damage Legible marking
SUB-GROUP C1 COMBINED SAMPLE OF SPECIMENS OF SUB-GROUPS C1A AND C1B		
4.10 Climatic sequence		
4.10.2 Dry heat	Temperature: + 105 °C Duration: 16 h	
4.10.3 Damp heat cyclic Test Db, first cycle		
4.10.4 Cold	Temperature: - 55 °C Duration: 2 h	
4.10.6 Damp heat cyclic Test Db remaining cycles		
4.10.6.2 Final measurements	Voltage proof = U_{RDC} for 1 min within 15 min after removal from test chamber Visual examination Capacitance Tangent of loss angle Insulation resistance	No breakdown or flash-over No visible damage Legible marking $ \Delta C/C \leq 3\%$ of the value measured initially Increase of $\tan \delta: \leq 0.002$ Compared to values measured in 4.3.1 or 4.6.1 as applicable $\geq 50\%$ of values specified in section "Insulation Resistance" of this specification
SUB-GROUP C2		
4.11 Damp heat steady state		
4.11.1 Initial measurements	Capacitance Tangent of loss angle at 1 kHz	
4.11.3 Final measurements	Visual examination Voltage proof = U_{RDC} for 1 min within 15 min after removal from test chamber Capacitance Tangent of loss angle Insulation resistance	No visible damage Legible marking No breakdown or flash-over $ \Delta C/C \leq 3\%$ of the value measured in 4.11.1. Increase of $\tan \delta \leq 0.002$ Compared to values measured in 4.11.1 $\geq 50\%$ of values specified in section "Insulation Resistance" of this specification



GROUP C INSPECTION REQUIREMENTS		
SUB-CLAUSE NUMBER AND TEST	CONDITIONS	PERFORMANCE REQUIREMENTS
SUB-GROUP C3A		
4.12.1 Endurance test at 50 Hz alternative voltage	Duration: 2000 h 1.25 x U _{RAC} at 85 °C 0.875 x U _{RAC} at 105 °C	
4.12.1.1 Initial measurements	Capacitance Tangent of loss angle at: For C > 1 µF at 1 kHz For C ≤ 1 µF at 10 kHz	
4.12.1.3 Final measurements	Visual examination	No visible damage Legible marking
	Capacitance	ΔC/C ≤ 5 % compared to values measured in 4.12.1.1
	Tangent of loss angle	Increase of tan δ: ≤ 0.0015 for C ≤ 1 µF ≤ 0.0015 for C > 1 µF Compared to values measured in 4.12.1.1
	Insulation resistance	≥ 50 % of values specified in section "Insulation Resistance" of this specification
SUB-GROUP C4		
4.2.6 Temperature characteristics Initial measurements Intermediate measurements	Capacitance Capacitance at - 55 °C Capacitance at 20 °C Capacitance at + 105 °C	For - 55 °C to 20 °C 0 % ≤ ΔC/C ≤ 2.75 % or For 20 °C to 105 °C - 5.5 % ≤ ΔC/C ≤ 0 % As specified in section "Capacitance" of this specification
4.13 Charge and discharge	10 000 cycles (1...50 c/s) 2.5 x (dU/dt) _R charge to U _{RDC} with maximum pulse slope ≤ 0.01 (dU/dt) _R Duration: 5 ms Discharge resistance: $R = \frac{U_n(V_{DC})}{2.5 \times C (dU/dt)}$	
4.13.1 Initial measurements	Capacitance Tangent of loss angle at: For C > 1 µF at 1 kHz For C ≤ 1 µF at 10 kHz	
4.13.3 Final measurements	Capacitance	ΔC/C ≤ 5 % compared to values measured in 4.13.1.
	Tangent of loss angle	Increase of tan δ: ≤ 0.0015 for C ≤ 1 µF ≤ 0.0015 for C > 1 µF Compared to values measured in 4.13.1
	Insulation resistance	≥ 50 % of values specified in section "Insulation Resistance" of this specification



Disclaimer

ALL PRODUCT, PRODUCT SPECIFICATIONS AND DATA ARE SUBJECT TO CHANGE WITHOUT NOTICE TO IMPROVE RELIABILITY, FUNCTION OR DESIGN OR OTHERWISE.

Vishay Intertechnology, Inc., its affiliates, agents, and employees, and all persons acting on its or their behalf (collectively, "Vishay"), disclaim any and all liability for any errors, inaccuracies or incompleteness contained in any datasheet or in any other disclosure relating to any product.

Vishay makes no warranty, representation or guarantee regarding the suitability of the products for any particular purpose or the continuing production of any product. To the maximum extent permitted by applicable law, Vishay disclaims (i) any and all liability arising out of the application or use of any product, (ii) any and all liability, including without limitation special, consequential or incidental damages, and (iii) any and all implied warranties, including warranties of fitness for particular purpose, non-infringement and merchantability.

Statements regarding the suitability of products for certain types of applications are based on Vishay's knowledge of typical requirements that are often placed on Vishay products in generic applications. Such statements are not binding statements about the suitability of products for a particular application. It is the customer's responsibility to validate that a particular product with the properties described in the product specification is suitable for use in a particular application. Parameters provided in datasheets and / or specifications may vary in different applications and performance may vary over time. All operating parameters, including typical parameters, must be validated for each customer application by the customer's technical experts. Product specifications do not expand or otherwise modify Vishay's terms and conditions of purchase, including but not limited to the warranty expressed therein.

Hyperlinks included in this datasheet may direct users to third-party websites. These links are provided as a convenience and for informational purposes only. Inclusion of these hyperlinks does not constitute an endorsement or an approval by Vishay of any of the products, services or opinions of the corporation, organization or individual associated with the third-party website. Vishay disclaims any and all liability and bears no responsibility for the accuracy, legality or content of the third-party website or for that of subsequent links.

Except as expressly indicated in writing, Vishay products are not designed for use in medical, life-saving, or life-sustaining applications or for any other application in which the failure of the Vishay product could result in personal injury or death. Customers using or selling Vishay products not expressly indicated for use in such applications do so at their own risk. Please contact authorized Vishay personnel to obtain written terms and conditions regarding products designed for such applications.

No license, express or implied, by estoppel or otherwise, to any intellectual property rights is granted by this document or by any conduct of Vishay. Product names and markings noted herein may be trademarks of their respective owners.

Looking for pricing, stock, or lifecycle information?

Click below to explore more details on WIN SOURCE:

 [View MKP386M447125JT5 on WIN SOURCE](#)

 [Vishay Information](#)

Optimize Your Supply Chain with WIN SOURCE Solutions

-  Global Sourcing Solution
-  Obsolete Management
-  Cost Control Management
-  Shortage Management
-  Alternative Solution
-  Excess Inventory Management