



**THE DATASHEET OF
MGA-61563-TR2G**



MGA-61563

Current-Adjustable, Low Noise Amplifier



Data Sheet

Description

Avago Technologies' MGA-61563 is an economical, easy-to-use GaAs MMIC amplifier that offers excellent linearity and low noise figure for applications from 0.1 to 6 GHz. Packaged in an miniature SOT-363 package, it requires half the board space of a SOT-143 package.

One external resistor is used to set the bias current taken by the device over a wide range. This allows the designer to use the same part in several circuit positions and tailor the linearity performance (and current consumption) to suit each position. The MGA-61563 is normally operating with I_d set in the 20-60mA range

The output of the amplifier is matched to 50Ω (below 2:1 VSWR) across the entire bandwidth and only requires minimum input matching. The amplifier allows a wide dynamic range by offering a 1.2 dB NF coupled with a +28.5 dBm Output IP3. The circuit uses state-of-the-art E-pHEMT technology with proven reliability. On-chip bias circuitry allows operation from a single +3V or +5V power supply, while internal feedback ensures stability ($K > 1$) over all frequencies.

Pin Connections and Package Marking

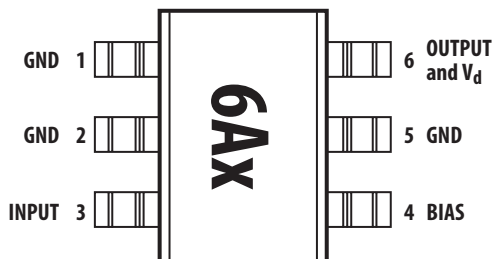

Note:
 Package marking provides orientation and identification:
 "6A" = Device Code
 "x" = Date code indicates the month of manufacture.

Features

- Single +3V or + 5V supply
- High linearity
- Low noise figure
- Miniature SOT363 (SC70) package
- Unconditionally stable
- Lead-free option available

Specifications at 2 GHz; 3V, 41 mA (Typ.)

- 28.5 dBm OIP3
- 1.2 dB noise figure
- 16.6 dB gain
- 15.8 dBm P_{1dB}

Package Diagram

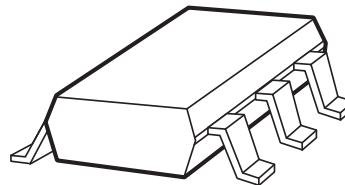

Attention: Observe precautions for handling electrostatic sensitive devices.
 ESD Machine Model (Class A)
 ESD Human Body Model (Class 0)
 Refer to Avago Technologies Application Note A004R: Electrostatic Discharge Damage and Control.

Simplified Schematic

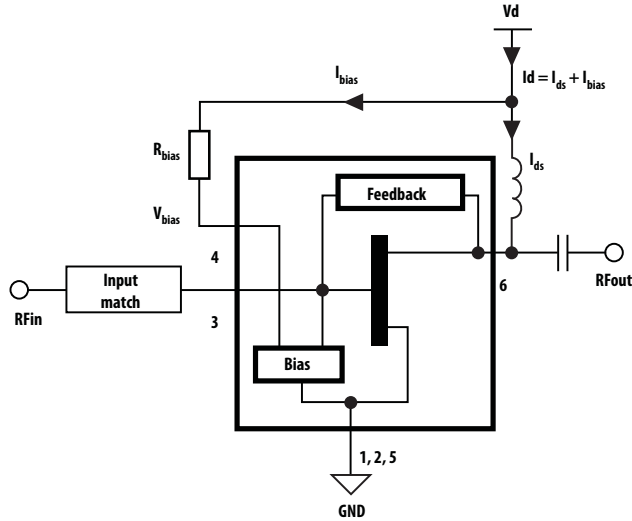

MGA-61563 Absolute Maximum Ratings^[1]

Symbol	Parameter	Units	Absolute Maximum
V_d	Device Voltage (pin 6) ^[2]	V	6
I_d	Device Current (pin 6) ^[2]	mA	100
P_{in}	CW RF Input Power (pin 3) ^[3]	dBm	18
I_{ref}	Bias Reference Current (pin 4)	mA	10
P_{diss}	Total Power Dissipation ^[4]	mW	500
T_{CH}	Channel Temperature	°C	150
T_{STG}	Storage Temperature	°C	-65 to 150
$\theta_{ch,b}$	Thermal Resistance ^[5]	°C/W	115

Notes:

- Operation of this device in excess of any one of these parameters may cause permanent damage.
- Assumes DC quiescent conditions.
- With the DC (typical bias) and RF applied to the device at board temperature $T_b = 25^\circ\text{C}$.
- Total dissipation power is referred to lead "x" temperature. $T_c=92.5^\circ\text{C}$, derate P_{diss} at $8.7\text{mW}/^\circ\text{C}$ for $T_c > 92.5^\circ\text{C}$.
- Thermal resistance measured using 150°C Liquid Crystal Measurement method.

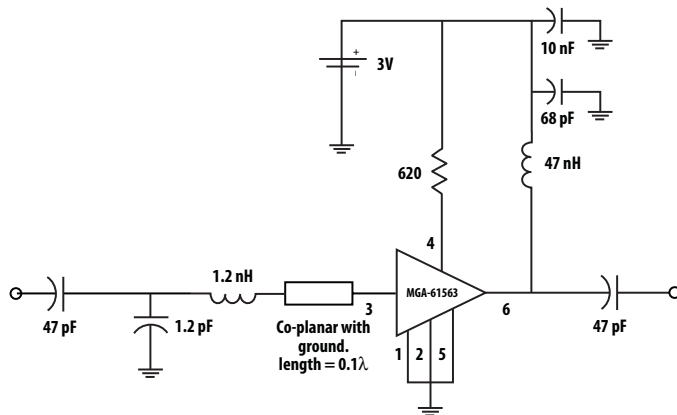
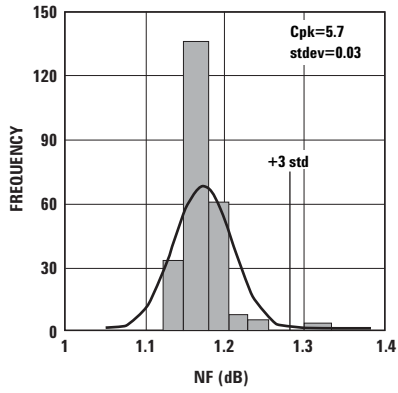
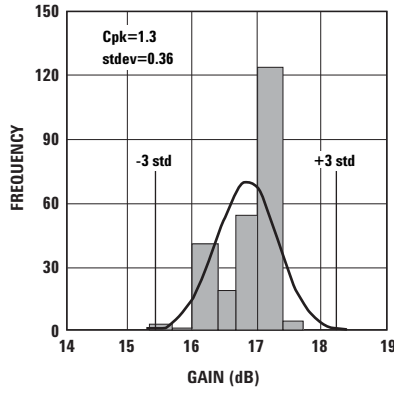

Figure 1. Test circuit of the 2 GHz production test board used for NF, Gain and OIP3 measurements. This circuit achieves a trade-off between optimal NF, Gain, OIP3 and input return loss. Circuit losses have been de-embedded from actual measurements.

Product Consistency Distribution Charts at 3V, 2 GHz, $R_{bias} = 620\Omega$ ^[1,2]



**Figure 2. NF @ 2 GHz 3V 40 mA.
USL=1.8, Nominal=1.17.**



**Figure 3. Gain @ 2 GHz 3V 40 mA.
USL=18, LSL=15, Nominal=16.6.**

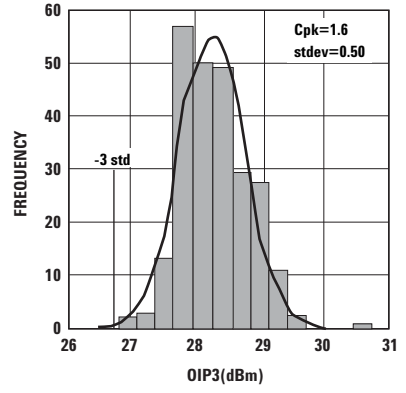

**Figure 4. OIP3 @ 2 GHz 3V 40 mA.
LSL=26, Nominal=28.5.**

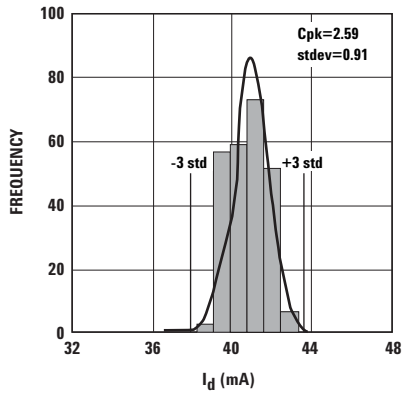

**Figure 5. Id @ 3V.
LSL=32, USL=48, Nominal=41.0.**

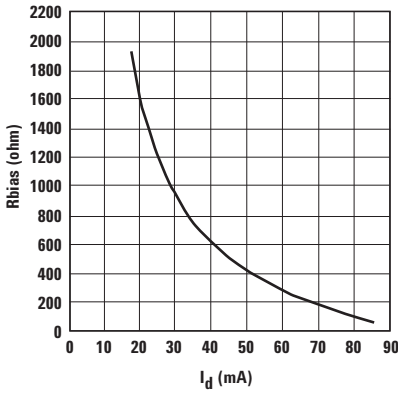

Figure 6. Rbias vs. Id (3V supply).

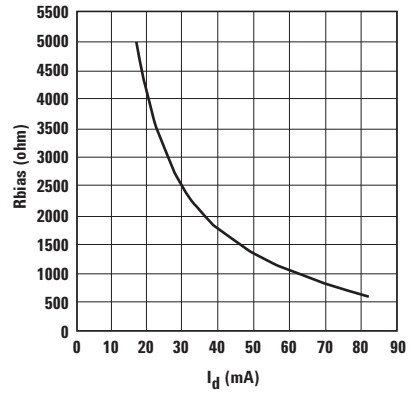

Figure 7. Rbias vs. Id (5V supply).

Note:

1. Measured on the production test circuit
2. Distribution data sample size is 250 samples taken from 5 different wafers. Future wafers allocated to this product may have nominal values anywhere between upper and lower limits.

MGA-61563 Electrical Specifications

Rbias = 620ohm

TC = 25°C, ZO = 50Ω, Vd = 3V (unless otherwise specified)

Symbol	Parameters and Test Conditions	Freq	Units	Min.	Typ.	Max.	Std Dev
$I_d^{[1,2]}$	Device Current		mA	32	41	48	0.91
$NF_{test}^{[1,2]}$	Noise Figure in test circuit ^[1]	f = 2.047 GHz	dB		1.17	1.8	0.03
$G_{test}^{[1,2]}$	Associated Gain in test circuit ^[1]	f = 2.047 GHz	dB	15	16.6	18	0.36
$OIP3_{test}^{[1,2]}$	Output 3 rd Order Intercept in test circuit ^[1]	f = 2 GHz	dBm	26	28.5		0.5
$NF_{50\Omega}^{[3]}$	Noise Figure in 50Ω system	f = 0.2 GHz f = 0.5 GHz f = 1.0 GHz f = 2.0 GHz f = 3.0 GHz f = 4.0 GHz f = 5.0 GHz f = 6.0 GHz	dB		1.4 1.1 0.9 1.0 1.4 1.8 2.3 2.7		0.03
$ S_{21} ^2^{[3]}$	Associated Gain in 50Ω system	f = 0.2 GHz f = 0.5 GHz f = 1.0 GHz f = 2.0 GHz f = 3.0 GHz f = 4.0 GHz f = 5.0 GHz f = 6.0 GHz	dB		21 20 19.3 15.5 12.4 10.4 8 6.9		0.36
$OIP3_{50\Omega}^{[3]}$	Output 3 rd Order Intercept Point in 50Ω system	f = 0.2 GHz f = 0.5 GHz f = 1.0 GHz f = 2.0 GHz f = 3.0 GHz f = 4.0 GHz f = 5.0 GHz f = 6.0 GHz	dBm		29 29.8 30.5 31.7 30.9 30.6 30.6 30.7		0.5
$P1dB_{50\Omega}^{[3]}$	Output Power at 1dB Gain Compression in 50Ω system	f = 0.2 GHz f = 0.5 GHz f = 1.0 GHz f = 2.0 GHz f = 3.0 GHz f = 4.0 GHz f = 5.0 GHz f = 6.0 GHz	dBm		15.6 15.5 15.4 15.1 15.1 14.8 14.6 14.6		

Notes:

1. Guaranteed specifications are 100% tested in the production test circuit as shown in Figure 1, the typical value is based on measurement of at least 500 parts from three non-consecutive wafer lots during initial characterization of this product.
2. Circuit achieved a trade-off between optimal NF, Gain, OIP3 and input return loss.
3. Parameter quoted at 50Ω is based on measurement of selected typical parts tested on a 50Ω input and output test fixture.

MGA-61563 Typical Performance, $V_d = 3V, I_{ds} = 40\text{ mA}$ at 50Ω Input and Output

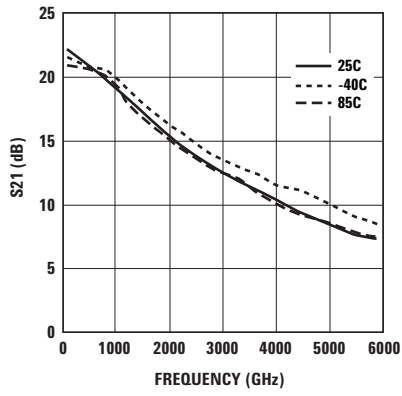

Figure 8. S21 vs. Frequency (3V 40 mA).

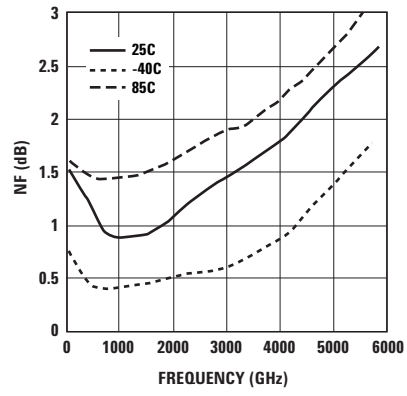

Figure 9. NF vs. Frequency (3V 40 mA).

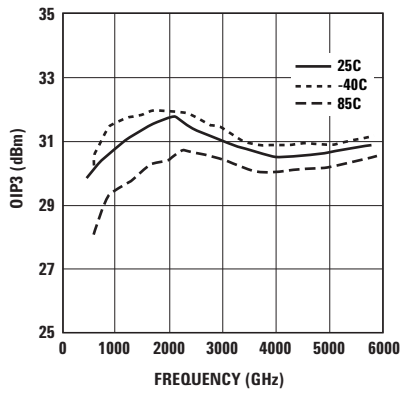

Figure 10. OIP3 vs. Frequency (3V 40 mA).

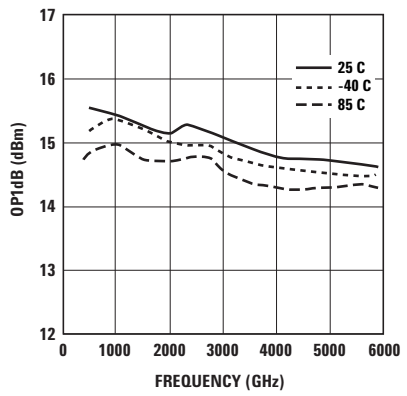

Figure 11. OP1dB vs. Frequency (3V 40 mA).

MGA-61563 Typical Performance, $V_d = 3V, I_{ds} = 20\text{ mA}$ at 50Ω Input and Output

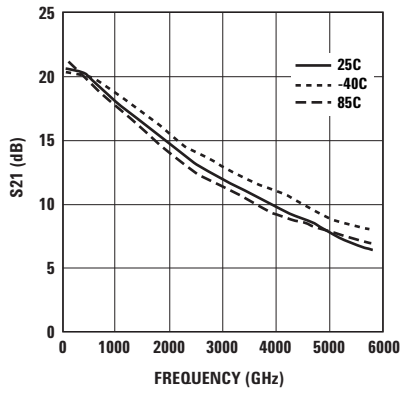

Figure 12. S21 vs. Freq (3V 20 mA).

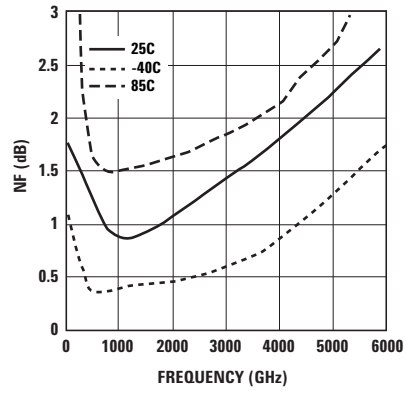

Figure 13. NF vs. Frequency (3V 20 mA).

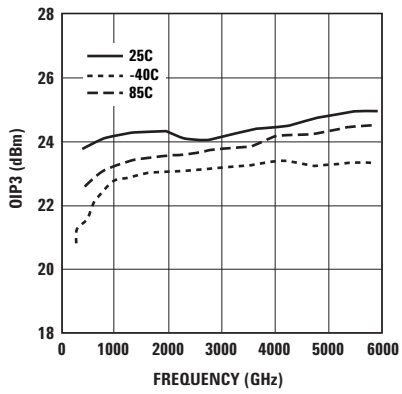

Figure 14. OIP3 vs. Frequency (3V 20 mA).

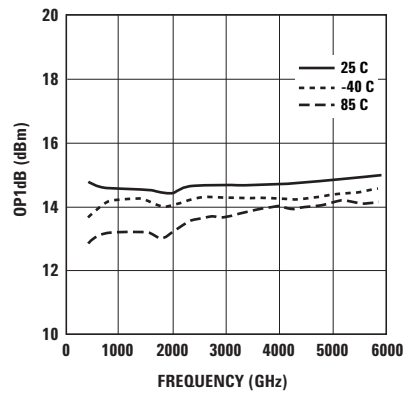

Figure 15. OP1dB vs. Frequency (3V 20 mA).

MGA-61563 Typical Performance, $V_d = 5V, I_{ds} = 40\text{ mA}$ at 50Ω Input and Output

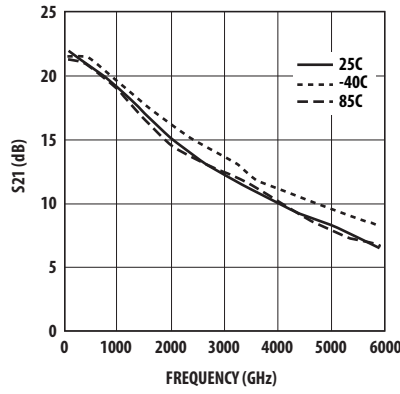

Figure 16. S21 vs. Frequency (5V 40 mA).

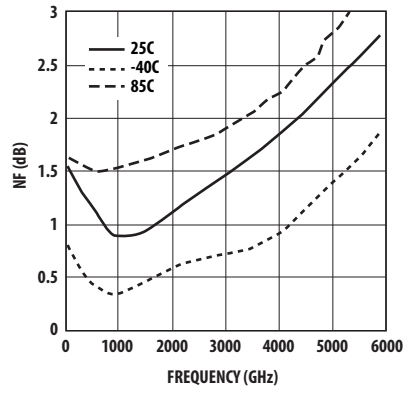

Figure 17. NF vs. Frequency (5V 40 mA).

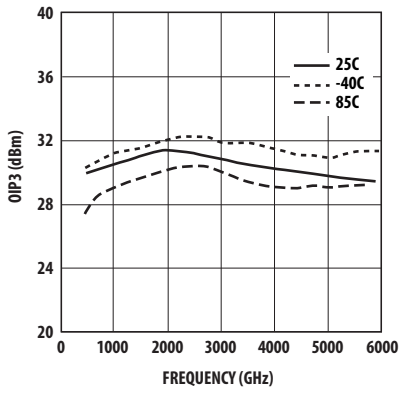

Figure 18. OIP3 vs. Frequency (5V 40 mA).

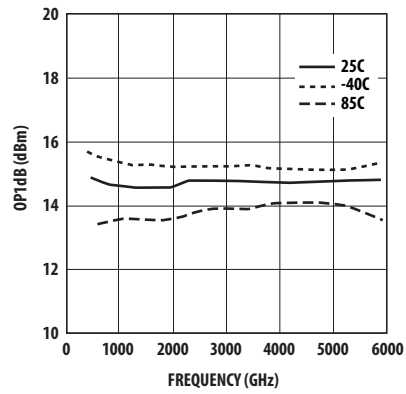

Figure 19. OP1dB vs. Frequency (5V 40 mA).

MGA-61563 Typical Performance, $V_d = 5V, I_{ds} = 20\text{ mA}$ at 50Ω Input and Output

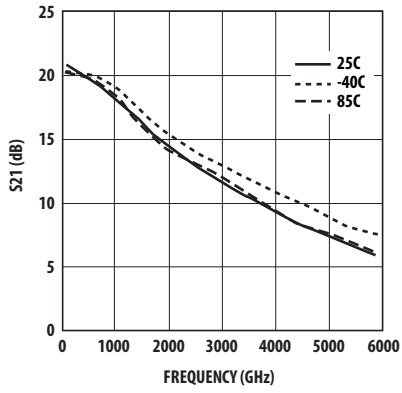

Figure 20. S21 vs. Frequency (5V 20 mA).

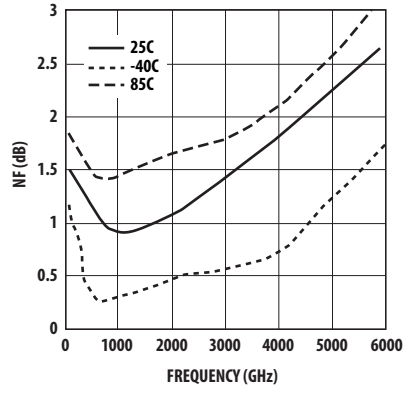

Figure 21. NF vs. Frequency (5V 20 mA).

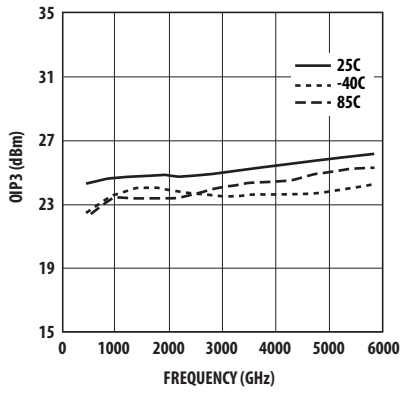

Figure 22. OIP3 vs. Frequency (5V 20 mA).

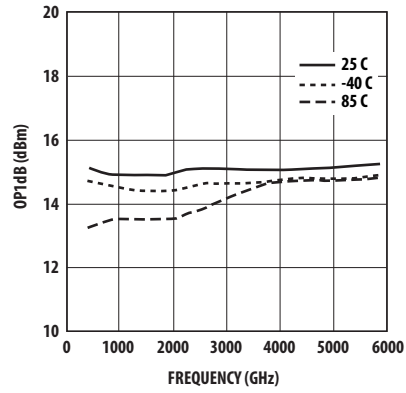

Figure 23. OP1dB vs. Frequency (5V 20 mA).

MGA-61563 Typical Performance, Freq = 2 GHz, $T_c = 25^\circ\text{C}$ at 50Ω Input and Output

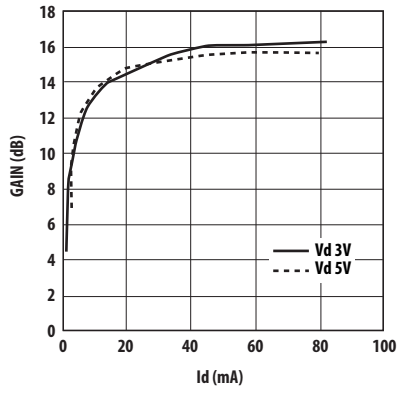

Figure 24. Gain vs. Id (2 GHz).

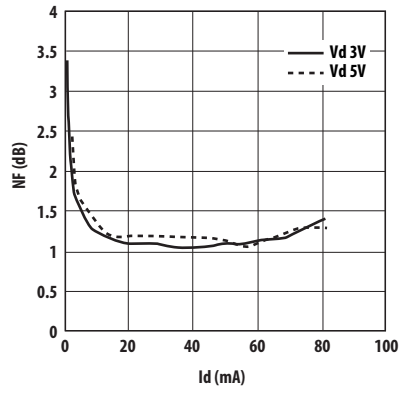

Figure 25. NF vs. Id (2 GHz).

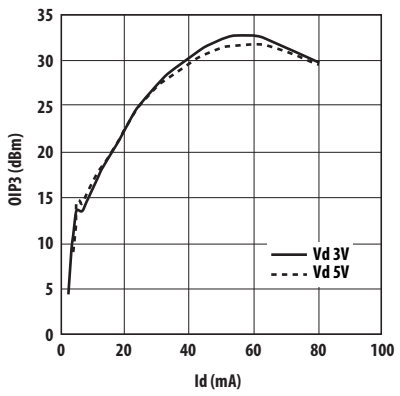

Figure 26. OIP3 vs. Id (2 GHz).

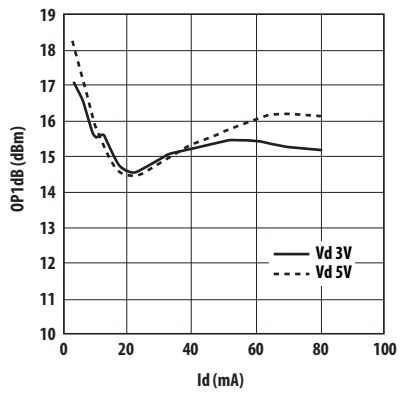

Figure 27. OP1dB vs. Id (2 GHz).

MGA-61563 Typical Performance, Freq = 0.9 GHz, $T_c = 25^\circ\text{C}$ at 50 Ω Input and Output

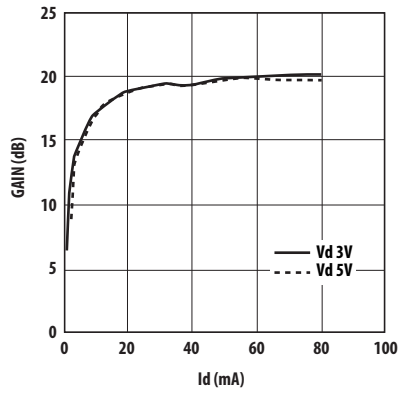

Figure 28. Gain vs. Id (900 MHz).

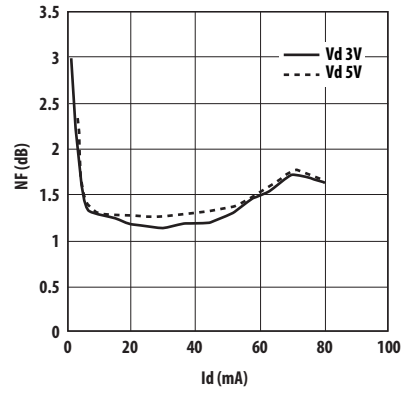

Figure 29. NF vs. Id (900 MHz).

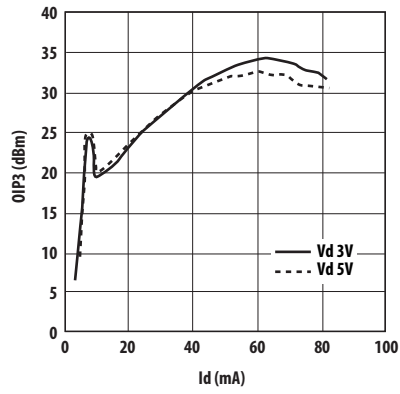

Figure 30. OIP3 vs. Id (900 MHz).

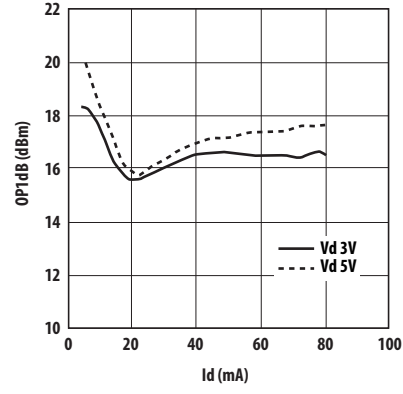

Figure 31. OP1dB vs. Id (900 MHz).

MGA-61563 Typical Scattering Parameters, $T_c = 25^\circ\text{C}$, $Z_0 = 50\Omega$, $V_d = 3\text{V}$, $I_{ds} = 40\text{ mA}$

Freq. GHz	S_{11}		S_{21}			S_{12}		S_{22}		K-factor
	Mag.	Ang.	dB	Mag.	Ang.	Mag.	Ang.	Mag.	Ang.	
0.1	0.244	-52.826	21.78	12.271	158.389	0.051	3.716	0.072	-77.426	1.05
0.2	0.236	-58.111	21.57	11.976	156.012	0.05	3.134	0.065	-86.51	1.08
0.3	0.23	-64.265	21.33	11.649	153.359	0.05	2.551	0.06	-97.578	1.09
0.4	0.227	-71.238	21.06	11.296	150.415	0.05	2.01	0.056	-110.098	1.11
0.5	0.226	-79.33	20.75	10.904	146.968	0.049	1.489	0.055	-123.83	1.14
0.6	0.229	-87.315	20.45	10.527	143.4	0.049	1.064	0.056	-135.935	1.16
0.7	0.235	-95.355	20.13	10.154	139.497	0.049	0.721	0.058	-146.064	1.18
0.8	0.245	-103.135	19.82	9.798	135.232	0.048	0.467	0.063	-154.126	1.22
0.9	0.258	-110.09	19.54	9.482	130.652	0.048	0.347	0.068	-160.307	1.24
1	0.275	-116.228	19.27	9.193	125.989	0.047	0.51	0.073	-163.445	1.27
1.1	0.292	-122.194	18.98	8.888	121.13	0.047	0.928	0.079	-165.335	1.28
1.2	0.307	-127.351	18.69	8.601	116.692	0.047	1.513	0.084	-166.694	1.3
1.3	0.32	-130.903	18.39	8.308	112.463	0.046	2.307	0.083	-166.078	1.34
1.4	0.329	-133.391	18.08	8.015	108.444	0.046	3.321	0.078	-163.135	1.37
1.5	0.339	-135.838	17.76	7.727	104.561	0.046	4.462	0.073	-158.92	1.4
1.6	0.348	-138.798	17.43	7.442	100.879	0.046	5.633	0.068	-155.687	1.43
1.7	0.355	-142.049	17.09	7.152	97.114	0.046	6.951	0.062	-149.155	1.47
1.8	0.359	-145.16	16.76	6.89	93.742	0.047	8.269	0.059	-142.409	1.48
1.9	0.36	-148.258	16.45	6.643	90.533	0.047	9.619	0.058	-135.389	1.53
2	0.361	-151.227	16.14	6.412	87.449	0.048	10.948	0.057	-128.787	1.54
2.5	0.363	-165.518	14.73	5.45	72.871	0.054	16.239	0.059	-98.235	1.6
3	0.352	175.694	13.46	4.711	59.275	0.062	18.051	0.07	-80.793	1.61
3.5	0.38	161.243	12.45	4.195	45.386	0.073	15.785	0.085	-54.713	1.52
4	0.425	144.109	11.37	3.703	31.615	0.084	12.477	0.102	-49.393	1.43
4.5	0.51	134.382	10.45	3.329	18.734	0.095	5.411	0.096	-47.475	1.29
5	0.593	117.447	9.32	2.923	3.55	0.103	-1.829	0.088	-42.299	1.2
5.5	0.645	108.198	8.29	2.596	-6.214	0.112	-7.541	0.065	-76.731	1.12
6	0.699	95.764	7.93	2.493	-19.424	0.118	-14.437	0.044	170.599	1
6.5	0.681	86.306	6.96	2.229	-28.714	0.126	-20.93	0.115	128.986	1.09
7	0.688	75.175	6.86	2.203	-41.406	0.133	-29.043	0.194	102.725	1.06
7.5	0.665	63.103	5.97	1.989	-54.247	0.136	-36.279	0.217	85.554	1.19
8	0.656	53.026	5.58	1.902	-63.34	0.145	-42.738	0.23	78.813	1.2
9	0.701	33.219	4.92	1.762	-84.127	0.156	-59.549	0.262	54.067	1.11
10	0.762	21.101	4.43	1.666	-99.91	0.157	-74.343	0.307	28.064	1.03

Typical Noise Parameters at 25°C , $T_c = 25^\circ\text{C}$, $Z_0 = 50\Omega$, $V_d = 3\text{V}$, $I_{ds} = 40\text{ mA}$

Freq GHz	F_{min} dB	Γ_{opt} Mag.	Γ_{opt} Ang.	$R_{n/50}$	NF@50Ω dB
0.5	0.65	0.02	84.7	0.09	0.65
1	0.59	0.05	146.6	0.08	0.6
1.5	0.71	0.09	154.5	0.08	0.72
2	0.81	0.1	135	0.09	0.83
2.5	0.86	0.12	166.7	0.08	0.89
3	0.91	0.18	-177.3	0.08	0.96
3.5	0.99	0.19	-161.8	0.09	1.05
4	1.11	0.23	-152.3	0.1	1.22
4.5	1.21	0.28	-141.5	0.11	1.38
5	1.29	0.32	-130.3	0.12	1.53
5.5	1.36	0.35	-121.5	0.16	1.68
6	1.47	0.39	-110.7	0.19	1.87
6.5	1.56	0.44	-100.5	0.26	2.1
7	1.58	0.48	-91.2	0.32	2.27
7.5	1.79	0.51	-80.2	0.43	2.61
8	1.88	0.54	-69.2	0.57	2.88
8.5	2	0.6	-58.7	0.76	3.3
9	2.14	0.63	-47.7	0.99	3.68
9.5	2.15	0.69	-41.9	1.22	4.09
10	2.16	0.71	-35.4	1.48	4.43

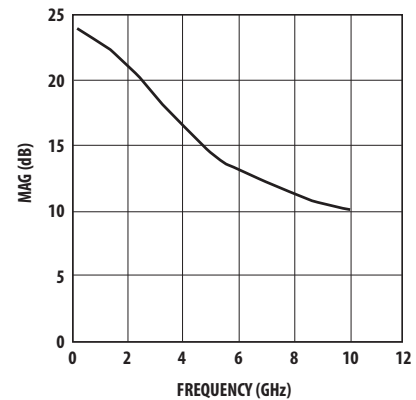

Figure 32. MAG vs. Frequency.

MGA-61563 Typical Scattering Parameters, $T_c = 25^\circ\text{C}$, $Z_0 = 50\Omega$, $V_d = 3\text{V}$, $I_{ds} = 30\text{ mA}$

Freq. GHz	S_{11}		dB	S_{21}		S_{12}		S_{22}		K-factor
	Mag.	Ang.		Mag.	Ang.	Mag.	Ang.	Mag.	Ang.	
0.1	0.268	-48.517	21.29	11.602	158.574	0.054	4.469	0.092	-62.567	1.05
0.2	0.258	-53.469	21.09	11.332	156.225	0.053	3.812	0.083	-69.778	1.07
0.3	0.251	-59.275	20.85	11.03	153.589	0.053	3.14	0.075	-78.771	1.08
0.4	0.246	-65.933	20.59	10.704	150.671	0.053	2.503	0.069	-89.392	1.1
0.5	0.243	-73.772	20.29	10.339	147.255	0.052	1.867	0.065	-101.948	1.13
0.6	0.244	-81.634	19.99	9.99	143.707	0.052	1.318	0.063	-114.085	1.15
0.7	0.248	-89.688	19.69	9.645	139.832	0.051	0.836	0.064	-125.177	1.18
0.8	0.255	-97.59	19.38	9.314	135.602	0.051	0.435	0.068	-134.833	1.2
0.9	0.267	-104.804	19.11	9.021	131.063	0.051	0.201	0.073	-142.722	1.22
1	0.283	-111.271	18.84	8.752	126.423	0.05	0.265	0.079	-147.664	1.24
1.1	0.3	-117.585	18.56	8.469	121.591	0.05	0.555	0.087	-151.397	1.26
1.2	0.314	-123.03	18.28	8.202	117.173	0.05	0.989	0.094	-154.377	1.27
1.3	0.326	-126.855	17.98	7.929	112.956	0.049	1.629	0.095	-154.689	1.31
1.4	0.336	-129.586	17.68	7.654	108.945	0.049	2.492	0.092	-152.631	1.33
1.5	0.347	-132.266	17.36	7.381	105.063	0.049	3.452	0.089	-149.881	1.36
1.6	0.355	-135.421	17.04	7.111	101.376	0.049	4.442	0.085	-148.048	1.39
1.7	0.362	-138.83	16.7	6.837	97.605	0.049	5.577	0.081	-143.895	1.43
1.8	0.366	-142.061	16.38	6.589	94.237	0.05	6.72	0.079	-139.902	1.44
1.9	0.367	-145.269	16.06	6.353	91.02	0.05	7.91	0.077	-135.856	1.49
2	0.367	-148.31	15.75	6.134	87.927	0.051	9.081	0.076	-132.128	1.5
2.5	0.369	-162.886	14.37	5.228	73.233	0.056	13.854	0.069	-112.239	1.59
3	0.358	178.083	13.13	4.532	59.415	0.065	15.479	0.07	-95.256	1.6
3.5	0.387	163.252	12.14	4.044	45.371	0.075	13.321	0.071	-63.465	1.53
4	0.431	145.58	11.07	3.577	31.36	0.086	10.193	0.085	-52.459	1.44
4.5	0.516	135.43	10.15	3.218	18.295	0.097	3.143	0.079	-47.033	1.31
5	0.598	118.103	9.04	2.833	2.86	0.104	-3.984	0.075	-37.084	1.23
5.5	0.648	108.768	8.02	2.518	-7.048	0.113	-9.465	0.051	-77.715	1.14
6	0.702	96.188	7.7	2.426	-20.33	0.118	-16.213	0.05	153.974	1.02
6.5	0.683	86.691	6.75	2.175	-29.679	0.127	-22.597	0.128	124.845	1.1
7	0.69	75.529	6.67	2.156	-42.376	0.134	-30.746	0.209	100.751	1.06
7.5	0.666	63.34	5.81	1.952	-55.232	0.137	-37.846	0.231	83.842	1.19
8	0.657	53.281	5.44	1.871	-64.235	0.145	-44.143	0.243	76.982	1.2
9	0.703	33.453	4.82	1.741	-84.776	0.156	-60.778	0.273	52.604	1.12
10	0.763	21.176	4.33	1.647	-100.492	0.157	-75.625	0.318	27.144	1.03

Typical Noise Parameters at 25°C , $T_c = 25^\circ\text{C}$, $Z_0 = 50\Omega$, $V_d = 3\text{V}$, $I_{ds} = 30\text{ mA}$

Freq GHz	F_{min} dB	Γ_{opt} Mag.	Γ_{opt} Ang.	$R_{n/50}$	NF@500 dB
0.5	0.77	0.11	63.4	0.12	0.79
1	0.62	0.05	129.5	0.08	0.62
1.5	0.72	0.07	153.9	0.08	0.73
2	0.82	0.1	129.6	0.09	0.83
2.5	0.87	0.12	159.3	0.08	0.89
3	0.9	0.17	178.3	0.08	0.95
3.5	0.97	0.19	-166.1	0.09	1.03
4	1.09	0.23	-155.1	0.09	1.19
4.5	1.2	0.27	-144.2	0.1	1.35
5	1.25	0.32	-132.2	0.12	1.48
5.5	1.34	0.35	-123	0.15	1.64
6	1.45	0.38	-113.4	0.18	1.81
6.5	1.55	0.43	-101.8	0.24	2.04
7	1.58	0.46	-92.6	0.3	2.19
7.5	1.75	0.5	-81.5	0.4	2.52
8	1.88	0.52	-70.5	0.54	2.79
8.5	2	0.59	-59.6	0.72	3.21
9	2.1	0.62	-49	0.93	3.57
9.5	2.07	0.7	-42.8	1.15	3.99
10	2.14	0.71	-36.3	1.4	4.31

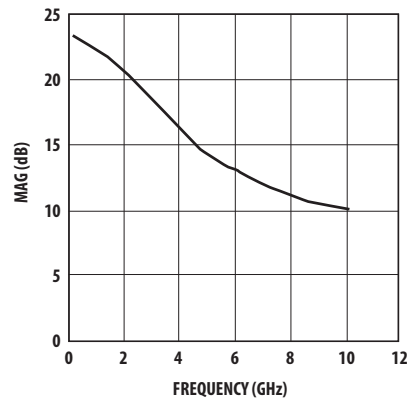

Figure 33. MAG vs. Frequency.

MGA-61563 Typical Scattering Parameters, $T_c = 25^\circ\text{C}$, $Z_0 = 50\Omega$, $V_d = 3\text{V}$, $I_{ds} = 20\text{mA}$

Freq. GHz	S_{11}		S_{21}			S_{12}		S_{22}		K-factor
	Mag.	Ang.	dB	Mag.	Ang.	Mag.	Ang.	Mag.	Ang.	
0.1	0.317	-41.61	20.39	10.456	159.109	0.058	4.817	0.143	-45.403	1.04
0.2	0.306	-45.966	20.2	10.23	156.718	0.058	4.054	0.131	-50.236	1.06
0.3	0.296	-51.142	19.98	9.976	154.046	0.058	3.271	0.119	-56.144	1.07
0.4	0.288	-57.155	19.74	9.704	151.101	0.058	2.496	0.108	-63.134	1.08
0.5	0.281	-64.371	19.46	9.392	147.615	0.057	1.698	0.098	-71.761	1.11
0.6	0.278	-71.779	19.17	9.093	144.033	0.057	0.976	0.091	-80.944	1.13
0.7	0.278	-79.591	18.89	8.798	140.143	0.056	0.298	0.087	-90.694	1.16
0.8	0.282	-87.467	18.6	8.516	135.916	0.056	-0.314	0.086	-100.877	1.18
0.9	0.291	-94.88	18.35	8.268	131.414	0.056	-0.765	0.089	-110.691	1.19
1	0.304	-101.73	18.11	8.043	126.841	0.055	-0.94	0.094	-118.635	1.21
1.1	0.319	-108.492	17.85	7.804	122.074	0.055	-0.918	0.101	-125.589	1.22
1.2	0.332	-114.307	17.59	7.578	117.72	0.055	-0.746	0.109	-131.351	1.23
1.3	0.344	-118.555	17.31	7.34	113.555	0.054	-0.378	0.112	-133.452	1.26
1.4	0.354	-121.708	17.02	7.094	109.6	0.054	0.196	0.112	-132.928	1.28
1.5	0.365	-124.791	16.72	6.852	105.757	0.054	0.873	0.112	-132.032	1.3
1.6	0.374	-128.258	16.41	6.611	102.099	0.054	1.593	0.11	-131.702	1.33
1.7	0.38	-131.932	16.08	6.367	98.359	0.054	2.446	0.109	-129.768	1.36
1.8	0.384	-135.369	15.77	6.144	95.013	0.054	3.34	0.108	-128.085	1.39
1.9	0.385	-138.717	15.47	5.933	91.816	0.054	4.303	0.107	-126.452	1.43
2	0.385	-141.873	15.17	5.735	88.751	0.055	5.276	0.107	-125.046	1.45
2.5	0.386	-156.845	13.84	4.919	74.118	0.06	9.497	0.095	-116.467	1.54
3	0.372	-176.34	12.65	4.292	60.211	0.067	11.134	0.088	-105.677	1.6
3.5	0.401	168.241	11.64	3.818	46.163	0.076	9.198	0.077	-84.858	1.56
4	0.44	149.229	10.64	3.404	32.101	0.087	7.141	0.073	-65.916	1.48
4.5	0.523	138.325	9.7	3.054	18.83	0.098	0.17	0.062	-57.413	1.34
5	0.604	120.138	8.67	2.712	3.31	0.105	-6.954	0.059	-28.01	1.26
5.5	0.654	110.499	7.51	2.375	-7.142	0.112	-12.561	0.047	-80.372	1.19
6	0.705	97.495	7.15	2.279	-20.172	0.12	-18.203	0.052	155.488	1.04
6.5	0.686	88.014	6.21	2.045	-29.442	0.127	-23.665	0.132	131.406	1.13
7	0.689	76.575	6.14	2.027	-42.37	0.134	-32.387	0.22	103.966	1.09
7.5	0.666	64.483	5.3	1.84	-55.579	0.138	-39.614	0.245	86.823	1.22
8	0.655	53.916	4.84	1.746	-65.154	0.143	-46.431	0.258	77.488	1.27
9	0.701	34.103	4.22	1.626	-85.653	0.155	-62.116	0.281	53.258	1.17
10	0.763	21.618	3.77	1.544	-101.686	0.156	-76.563	0.324	27.685	1.06

Typical Noise Parameters at 25°C , $T_c = 25^\circ\text{C}$, $Z_0 = 50\Omega$, $V_d = 3\text{V}$, $I_{ds} = 20\text{mA}$

Freq GHz	F_{min} dB	Γ_{opt} Mag.	Γ_{opt} Ang.	$R_{n/50}$	NF@50Ω dB
0.5	0.83	0.16	73.5	0.14	0.87
1	0.65	0.06	102.7	0.09	0.65
1.5	0.75	0.08	130.2	0.08	0.76
2	0.84	0.11	116.9	0.09	0.85
2.5	0.89	0.13	146.5	0.09	0.91
3	0.92	0.17	169.2	0.08	0.97
3.5	0.99	0.19	-173.3	0.08	1.06
4	1.1	0.23	-159.9	0.09	1.21
4.5	1.19	0.27	-148	0.1	1.35
5	1.28	0.31	-136.6	0.11	1.5
5.5	1.35	0.34	-126.6	0.14	1.64
6	1.48	0.37	-116.7	0.17	1.83
6.5	1.57	0.41	-104.4	0.23	2.04
7	1.61	0.45	-95.6	0.29	2.2
7.5	1.8	0.49	-83.8	0.39	2.53
8	1.9	0.51	-72.7	0.52	2.79
8.5	2.04	0.58	-61.7	0.7	3.21
9	2.15	0.61	-50.6	0.9	3.55
9.5	2.14	0.67	-44	1.14	3.95
10	2.15	0.7	-37.2	1.39	4.29

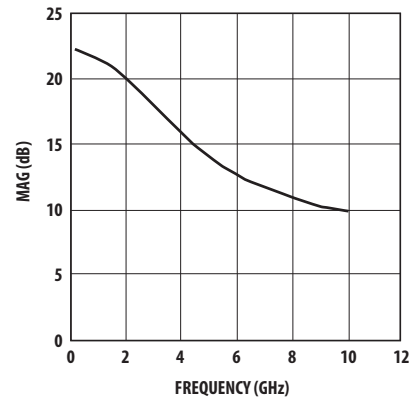

Figure 34. MAG vs. Frequency.

MGA-61563 Typical Scattering Parameters, $T_c = 25^\circ\text{C}$, $Z_0 = 50\Omega$, $V_d = 5\text{V}$, $I_{ds} = 40\text{mA}$

Freq. GHz	S_{11}		S_{21}			S_{12}		S_{22}		K-factor
	Mag.	Ang.	dB	Mag.	Ang.	Mag.	Ang.	Mag.	Ang.	
0.1	0.258	-51.172	21.73	12.198	158.061	0.052	2.014	0.099	-40.087	1.05
0.2	0.25	-56.504	21.51	11.904	155.623	0.051	1.092	0.088	-41.652	1.08
0.3	0.244	-62.709	21.27	11.575	152.898	0.051	0.144	0.077	-43.544	1.09
0.4	0.24	-69.739	21	11.221	149.889	0.05	-0.783	0.067	-45.521	1.12
0.5	0.24	-77.893	20.69	10.827	146.375	0.05	-1.732	0.057	-47.607	1.14
0.6	0.243	-85.926	20.38	10.448	142.735	0.049	-2.589	0.048	-49.573	1.17
0.7	0.249	-94.008	20.06	10.073	138.745	0.048	-3.388	0.041	-51.583	1.21
0.8	0.259	-101.823	19.75	9.715	134.387	0.047	-4.111	0.036	-55.087	1.25
0.9	0.274	-108.855	19.46	9.397	129.712	0.046	-4.673	0.031	-60.334	1.28
1	0.291	-115.109	19.19	9.106	124.959	0.045	-4.885	0.03	-67.768	1.32
1.1	0.31	-121.201	18.89	8.797	120.01	0.044	-4.77	0.031	-76.35	1.35
1.2	0.325	-126.478	18.6	8.508	115.497	0.043	-4.403	0.033	-84.716	1.4
1.3	0.338	-130.224	18.29	8.209	111.193	0.042	-3.717	0.038	-81.521	1.45
1.4	0.349	-132.947	17.96	7.906	107.096	0.042	-2.688	0.046	-73.894	1.48
1.5	0.36	-135.631	17.63	7.608	103.15	0.041	-1.392	0.056	-69.713	1.53
1.6	0.369	-138.76	17.29	7.316	99.402	0.04	0.046	0.063	-66.588	1.6
1.7	0.377	-142.177	16.92	7.018	95.57	0.04	1.77	0.074	-63.873	1.64
1.8	0.381	-145.435	16.59	6.75	92.158	0.04	3.589	0.084	-62.939	1.69
1.9	0.383	-148.667	16.25	6.495	88.904	0.04	5.522	0.093	-62.666	1.74
2	0.384	-151.757	15.93	6.259	85.777	0.04	7.523	0.101	-62.671	1.79
2.5	0.388	-166.702	14.45	5.277	71.099	0.044	16.605	0.134	-62.685	1.87
3	0.377	174.185	13.14	4.537	57.53	0.052	21.513	0.158	-62.054	1.84
3.5	0.405	159.567	12.1	4.029	43.534	0.063	21.058	0.179	-57.887	1.66
4	0.45	142.877	11	3.547	29.723	0.074	18.662	0.194	-60.531	1.52
4.5	0.535	132.993	10.09	3.196	16.674	0.085	12.703	0.179	-66.476	1.33
5	0.615	116.64	8.97	2.808	1.33	0.095	5.687	0.158	-70.76	1.19
5.5	0.67	107.318	7.97	2.504	-8.953	0.105	-0.575	0.141	-91.464	1.07
6	0.719	95.017	6.79	2.184	-22.571	0.109	-7.968	0.107	-131.65	1.05
6.5	0.701	85.67	6.62	2.143	-32.187	0.12	-14.662	0.115	177.351	1.05
7	0.705	74.436	6.51	2.116	-44.867	0.128	-22.574	0.154	134.222	1.03
7.5	0.68	62.659	5.68	1.923	-57.763	0.133	-30.248	0.171	111.828	1.16
8	0.672	52.622	5.31	1.842	-67.109	0.142	-37.545	0.189	102.359	1.16
9	0.713	32.981	4.67	1.712	-87.656	0.153	-55.08	0.214	73.631	1.08
10	0.775	20.843	4.22	1.625	-103.367	0.154	-69.156	0.252	42.168	0.98

Typical Noise Parameters at 25°C , $T_c = 25^\circ\text{C}$, $Z_0 = 50\Omega$, $V_d = 5\text{V}$, $I_{ds} = 40\text{mA}$

Freq GHz	F_{min} dB	Γ_{opt} Mag.	Γ_{opt} Ang.	$R_{n/50}$	NF@50Ω dB
0.5	0.78	0.11	53.9	0.13	0.8
1	0.62	0.04	128.5	0.09	0.62
1.5	0.73	0.06	153.5	0.08	0.73
2	0.85	0.07	128.5	0.09	0.86
2.5	0.89	0.1	165.3	0.09	0.9
3	0.94	0.14	-176.9	0.09	0.9
3.5	1	0.16	-160	0.09	1.04
4	1.11	0.2	-151.4	0.1	1.19
4.5	1.2	0.24	-141	0.11	1.33
5	1.28	0.29	-129.1	0.13	1.47
5.5	1.33	0.33	-120.7	0.15	1.59
6	1.44	0.35	-110.4	0.19	1.75
6.5	1.51	0.4	-99.6	0.24	1.96
7	1.56	0.44	-90.9	0.3	2.12
7.5	1.73	0.48	-79.6	0.4	2.44
8	1.87	0.5	-68.5	0.53	2.71
8.5	1.98	0.57	-58.2	0.7	3.12
9	2.08	0.61	-47.5	0.9	3.49
9.5	2.06	0.68	-42	1.12	3.89
10	2.14	0.69	-35.9	1.37	4.22

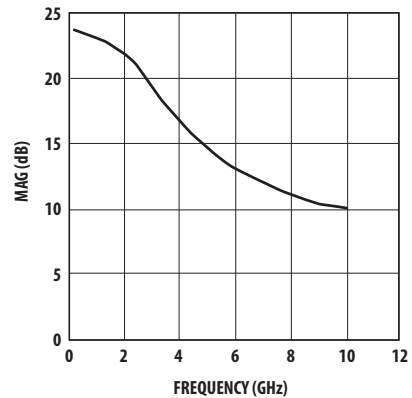

Figure 35. MAG vs. Frequency.

MGA-61563 Typical Scattering Parameters, $T_c = 25^\circ\text{C}$, $Z_0 = 50\Omega$, $V_d = 5\text{V}$, $I_{ds} = 30\text{mA}$

Freq. GHz	S_{11}		S_{21}			S_{12}		S_{22}		K-factor
	Mag.	Ang.	dB	Mag.	Ang.	Mag.	Ang.	Mag.	Ang.	
0.1	0.282	-47.273	21.25	11.545	158.421	0.054	2.527	0.125	-36.093	1.05
0.2	0.272	-52.214	21.04	11.27	155.969	0.054	1.488	0.114	-37.862	1.07
0.3	0.264	-58.016	20.8	10.965	153.232	0.053	0.415	0.103	-39.985	1.09
0.4	0.259	-64.681	20.54	10.638	150.206	0.053	-0.65	0.091	-42.301	1.11
0.5	0.256	-72.528	20.23	10.272	146.663	0.052	-1.766	0.08	-44.918	1.14
0.6	0.256	-80.402	19.93	9.922	142.996	0.051	-2.788	0.071	-47.629	1.17
0.7	0.26	-88.469	19.63	9.578	139	0.05	-3.768	0.063	-50.716	1.21
0.8	0.268	-96.405	19.32	9.25	134.641	0.05	-4.68	0.056	-55.147	1.23
0.9	0.281	-103.674	19.05	8.961	129.987	0.049	-5.425	0.051	-60.877	1.26
1	0.297	-110.223	18.79	8.696	125.265	0.048	-5.785	0.05	-67.861	1.29
1.1	0.315	-116.613	18.5	8.417	120.35	0.047	-5.857	0.05	-75.638	1.32
1.2	0.33	-122.127	18.23	8.154	115.866	0.046	-5.678	0.052	-83.182	1.36
1.3	0.343	-126.084	17.93	7.878	111.58	0.045	-5.186	0.056	-82.888	1.4
1.4	0.354	-129.004	17.61	7.596	107.501	0.044	-4.359	0.062	-78.454	1.46
1.5	0.365	-131.861	17.29	7.319	103.564	0.043	-3.279	0.07	-75.544	1.51
1.6	0.375	-135.138	16.96	7.046	99.816	0.043	-2.061	0.077	-73.137	1.54
1.7	0.382	-138.684	16.61	6.766	95.994	0.042	-0.558	0.086	-70.555	1.62
1.8	0.387	-142.036	16.28	6.515	92.571	0.042	1.067	0.094	-69.368	1.66
1.9	0.389	-145.346	15.95	6.276	89.309	0.042	2.822	0.102	-68.763	1.7
2	0.389	-148.494	15.64	6.053	86.177	0.042	4.665	0.109	-68.463	1.75
2.5	0.393	-163.628	14.19	5.125	71.41	0.045	13.477	0.137	-67.173	1.88
3	0.381	177.076	12.92	4.427	57.703	0.052	18.694	0.159	-65.551	1.88
3.5	0.409	162.094	11.91	3.941	43.681	0.062	18.816	0.175	-60.851	1.72
4	0.453	144.8	10.84	3.483	29.8	0.073	16.991	0.189	-62.503	1.56
4.5	0.537	134.597	9.94	3.14	16.717	0.084	11.108	0.173	-68.306	1.37
5	0.617	117.757	8.85	2.769	1.308	0.094	4.307	0.153	-71.488	1.22
5.5	0.67	108.305	7.85	2.468	-8.99	0.104	-1.653	0.139	-92.844	1.1
6	0.72	95.794	7.38	2.34	-22.47	0.107	-8.815	0.107	-134.127	1
6.5	0.7	86.37	6.52	2.118	-32.009	0.119	-15.413	0.12	175.651	1.07
7	0.705	75.123	6.41	2.091	-44.651	0.127	-23.384	0.159	133.509	1.04
7.5	0.679	63.192	5.56	1.897	-57.508	0.133	-30.963	0.176	111.275	1.18
8	0.67	53.114	5.17	1.813	-66.739	0.142	-38.146	0.193	101.783	1.18
9	0.712	33.367	4.51	1.68	-87.168	0.152	-55.653	0.218	73.301	1.1
10	0.775	21.236	4.06	1.595	-102.74	0.154	-69.795	0.255	41.842	0.99

Typical Noise Parameters at 25°C , $T_c = 25^\circ\text{C}$, $Z_0 = 50\Omega$, $V_d = 5\text{V}$, $I_{ds} = 30\text{mA}$

Freq GHz	F_{min} dB	Γ_{opt} Mag.	Γ_{opt} Ang.	$R_{n/50}$	NF@50Ω dB
0.5	0.77	0.12	64.1	0.13	0.8
1	0.62	0.04	123.1	0.09	0.62
1.5	0.72	0.05	151.4	0.08	0.72
2	0.84	0.07	120	0.09	0.84
2.5	0.87	0.09	158.2	0.09	0.88
3	0.9	0.13	178.1	0.09	0.92
3.5	0.96	0.15	-164.5	0.09	1
4	1.07	0.19	-154.2	0.1	1.14
4.5	1.14	0.24	-144.3	0.11	1.26
5	1.22	0.28	-132.8	0.12	1.38
5.5	1.27	0.31	-122.6	0.14	1.5
6	1.37	0.34	-112.9	0.17	1.65
6.5	1.43	0.39	-101.4	0.22	1.83
7	1.49	0.43	-92.7	0.27	1.99
7.5	1.65	0.47	-81	0.36	2.29
8	1.77	0.5	-69.6	0.48	2.56
8.5	1.91	0.56	-59.6	0.63	2.96
9	2.01	0.59	-48.6	0.81	3.27
9.5	1.92	0.69	-43.2	1.01	3.68
10	2.06	0.68	-36.2	1.25	4

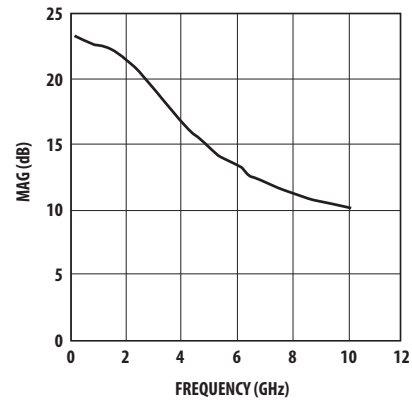

Figure 36. MAG vs. Frequency.

MGA-61563 Typical Scattering Parameters, $T_c = 25^\circ\text{C}$, $Z_0 = 50\Omega$, $V_d = 5\text{V}$, $I_{ds} = 20\text{mA}$

Freq. GHz	S_{11}		S_{21}			S_{12}		S_{22}		K-factor
	Mag.	Ang.	dB	Mag.	Ang.	Mag.	Ang.	Mag.	Ang.	
0.1	0.331	-40.707	20.31	10.36	158.971	0.059	2.846	0.185	-30.332	1.05
0.2	0.319	-44.963	20.12	10.137	156.547	0.059	1.7	0.172	-32.385	1.06
0.3	0.309	-50.03	19.9	9.887	153.841	0.058	0.505	0.159	-34.783	1.08
0.4	0.301	-55.929	19.66	9.616	150.853	0.058	-0.704	0.146	-37.412	1.1
0.5	0.294	-63.008	19.38	9.306	147.332	0.057	-1.994	0.133	-40.517	1.13
0.6	0.29	-70.33	19.09	9.01	143.712	0.056	-3.204	0.121	-43.825	1.16
0.7	0.29	-78.057	18.81	8.716	139.78	0.055	-4.392	0.112	-47.629	1.19
0.8	0.294	-85.875	18.52	8.437	135.504	0.054	-5.549	0.104	-52.456	1.22
0.9	0.303	-93.285	18.27	8.191	130.948	0.054	-6.523	0.097	-58.097	1.24
1	0.316	-100.155	18.03	7.968	126.318	0.053	-7.137	0.094	-64.409	1.26
1.1	0.331	-106.942	17.77	7.733	121.496	0.052	-7.508	0.093	-71.291	1.29
1.2	0.344	-112.823	17.51	7.51	117.077	0.051	-7.647	0.093	-77.932	1.32
1.3	0.357	-117.203	17.23	7.271	112.853	0.05	-7.501	0.096	-80.117	1.35
1.4	0.368	-120.52	16.93	7.021	108.827	0.049	-7.029	0.101	-79.373	1.4
1.5	0.379	-123.767	16.62	6.776	104.931	0.048	-6.314	0.107	-78.854	1.44
1.6	0.389	-127.358	16.3	6.531	101.213	0.047	-5.473	0.111	-78.207	1.5
1.7	0.396	-131.175	15.96	6.282	97.413	0.046	-4.37	0.118	-76.956	1.56
1.8	0.4	-134.737	15.65	6.057	94.01	0.046	-3.118	0.124	-76.359	1.6
1.9	0.402	-138.207	15.33	5.842	90.761	0.045	-1.695	0.13	-76.042	1.67
2	0.402	-141.477	15.03	5.641	87.643	0.045	-0.143	0.135	-75.885	1.72
2.5	0.404	-157.085	13.63	4.804	72.875	0.047	8.011	0.153	-74.696	1.88
3	0.389	-176.871	12.4	4.169	58.96	0.053	13.668	0.169	-72.122	1.92
3.5	0.417	167.303	11.41	3.718	44.745	0.062	14.795	0.178	-67.081	1.79
4	0.458	148.948	10.34	3.29	30.571	0.072	13.936	0.188	-67.525	1.66
4.5	0.541	137.725	9.43	2.963	17.214	0.083	8.672	0.17	-73.406	1.45
5	0.619	120.137	8.36	2.618	1.451	0.092	2.399	0.149	-75.625	1.3
5.5	0.672	110.331	7.35	2.33	-9.183	0.102	-3.087	0.139	-97.024	1.17
6	0.722	97.526	7.02	2.243	-22.946	0.106	-10.004	0.113	-138.094	1.03
6.5	0.701	87.871	6.05	2.006	-32.817	0.118	-16.47	0.13	175.134	1.11
7	0.705	76.467	5.95	1.983	-45.703	0.126	-24.412	0.169	134.908	1.08
7.5	0.678	64.317	5.12	1.803	-58.887	0.131	-31.864	0.184	112.812	1.23
8	0.667	54.179	4.75	1.728	-68.247	0.141	-38.968	0.199	103.027	1.23
9	0.71	34.216	4.16	1.614	-88.806	0.151	-56.487	0.221	74.675	1.13
10	0.776	21.827	3.75	1.54	-104.552	0.152	-70.39	0.257	43.118	1.01

Typical Noise Parameters at 25°C , $T_c = 25^\circ\text{C}$, $Z_0 = 50\Omega$, $V_d = 5\text{V}$, $I_{ds} = 20\text{mA}$

Freq GHz	F_{min} dB	Γ_{opt} Mag.	Γ_{opt} Ang.	$R_{n/50}$	NF@500 dB
0.5	0.8	0.12	71.2	0.13	0.83
1	0.64	0.04	103.7	0.09	0.64
1.5	0.74	0.05	128.4	0.09	0.74
2	0.84	0.08	107.3	0.1	0.85
2.5	0.88	0.1	143.3	0.09	0.89
3	0.91	0.13	167.4	0.09	0.93
3.5	0.95	0.15	-173.7	0.09	0.99
4	1.04	0.19	-160.6	0.09	1.11
4.5	1.12	0.23	-148.9	0.1	1.23
5	1.19	0.27	-137	0.11	1.34
5.5	1.26	0.3	-126.7	0.13	1.47
6	1.34	0.32	-116.7	0.16	1.6
6.5	1.43	0.37	-104.8	0.21	1.79
7	1.48	0.4	-95.8	0.25	1.92
7.5	1.65	0.45	-84.2	0.33	2.22
8	1.72	0.48	-72.6	0.44	2.44
8.5	1.87	0.55	-61.5	0.59	2.85
9	1.99	0.58	-50	0.76	3.16
9.5	1.94	0.66	-44.5	0.95	3.54
10	1.99	0.68	-37.7	1.16	3.84

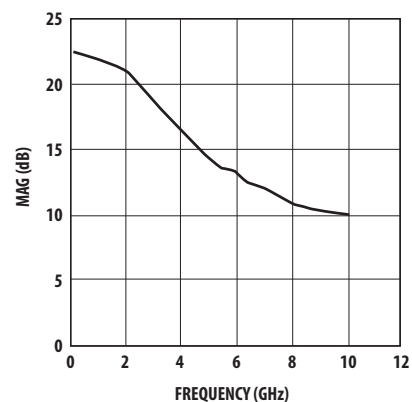

Figure 37. MAG vs. Frequency.

Refer to Avago Technologies Web Site for S-parameters at different biases: www.avagotech.com

Device Models

Refer to Avago Technologies Web Site : www.avagotech.com/view/rf.

Ordering Information

Part Number	No. of Devices	Container
MGA-61563-TR1G	3000	7" Reel
MGA-61563-TR2G	10000	13" Reel
MGA-61563-BLKG	100	antistatic bag

SOT-363/SC-70 (JEDEC DFP-N) Package Dimensions

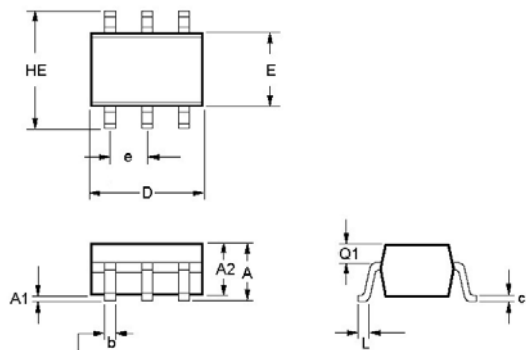

Dimensions		
Symbol	Min (mm)	Max (mm)
E	1.15	1.35
D	1.80	2.25
HE	1.80	2.40
A	0.80	1.10
A2	0.80	1.00
A1	0.00	0.10
e	0.650 BCS	0.650 BCS
b	0.15	0.30
c	0.10	0.20
L	0.10	0.30

Recommended PCB Pad Layout for Agilent's SC70 6L/SOT-363 Products

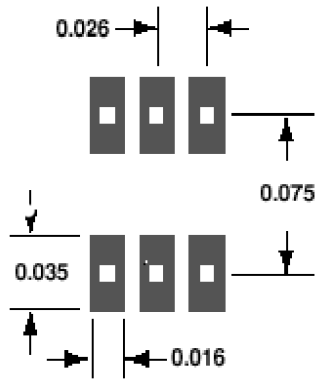

(dimensions in inches)

Device Orientation

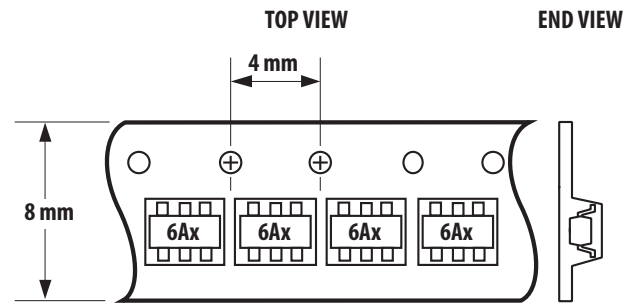
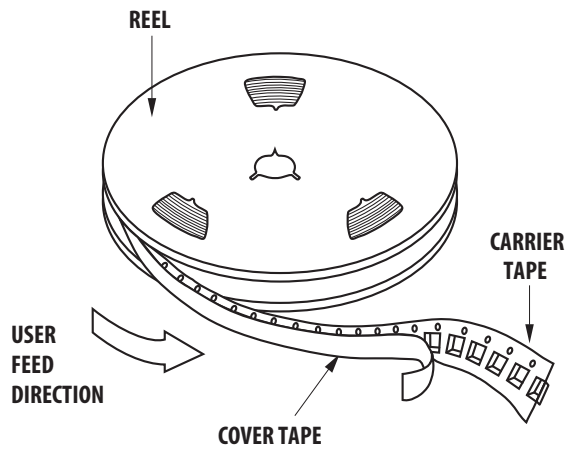

(Package marking example orientation shown.)

Tape Dimensions

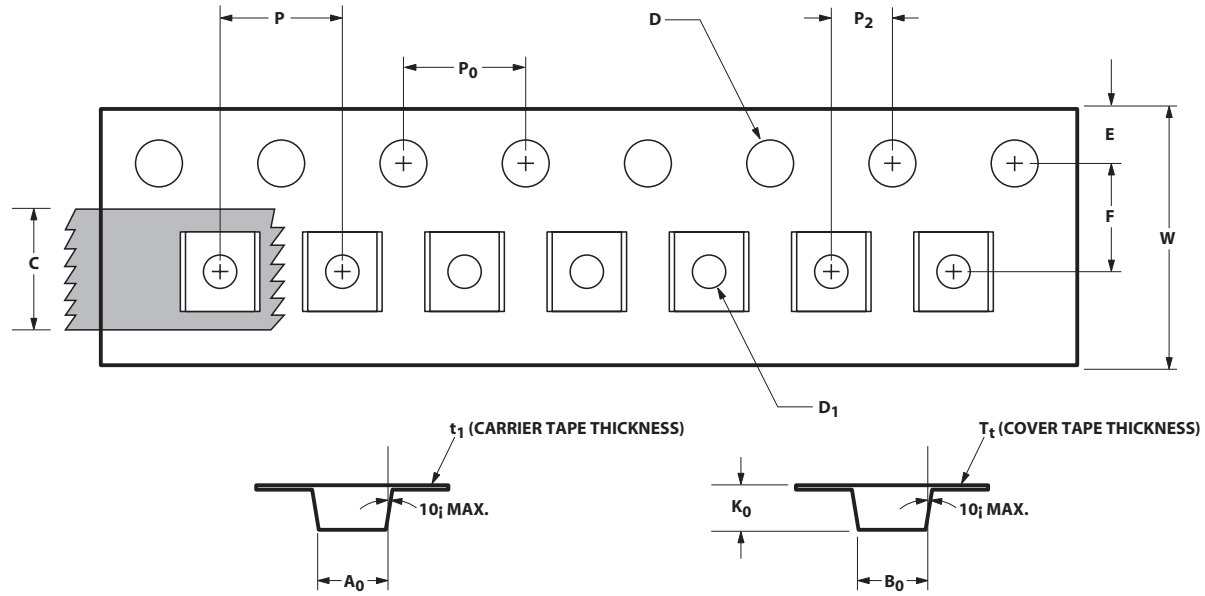

DESCRIPTION		SYMBOL	SIZE (mm)	SIZE (INCHES)
CAVITY	LENGTH	A ₀	2.40 ± 0.10	0.094 ± 0.004
	WIDTH	B ₀	2.40 ± 0.10	0.094 ± 0.004
	DEPTH	K ₀	1.20 ± 0.10	0.047 ± 0.004
	PITCH	P	4.00 ± 0.10	0.157 ± 0.004
	BOTTOM HOLE DIAMETER	D ₁	1.00 + 0.25	0.039 + 0.010
PERFORATION	DIAMETER	D	1.50 ± 0.10	0.061 ± 0.002
	PITCH	P ₀	4.00 ± 0.10	0.157 ± 0.004
	POSITION	E	1.75 ± 0.10	0.069 ± 0.004
CARRIER TAPE	WIDTH	W	8.00±0.30-0.10	0.315 ± 0.012
	THICKNESS	t ₁	0.254 ± 0.02	0.010 ± 0.0005
COVER TAPE	WIDTH	C	5.40 ± 0.10	0.205 ± 0.004
	TAPE THICKNESS	T _t	0.062 ± 0.001	0.0025 ± 0.00004
DISTANCE	CAVITY TO PERFORATION (WIDTH DIRECTION)	F	3.50 ± 0.05	0.138 ± 0.002
	CAVITY TO PERFORATION (LENGTH DIRECTION)	P ₂	2.00 ± 0.05	0.079 ± 0.002



MGA-81563 Tape Dimensions
MGA-81563 Tape Dimensions chart

For product information and a complete list of distributors, please go to our web site: www.avagotech.com

Avago, Avago Technologies, and the A logo are trademarks of Avago Technologies in the United States and other countries. Data subject to change. Copyright © 2005-2011 Avago Technologies. All rights reserved. Obsoletes 5989-1811EN AV02-1471EN - August 5, 2011

Looking for pricing, stock, or lifecycle information?

Click below to explore more details on WIN SOURCE:

-  [View MGA-61563-TR2G on WIN SOURCE](#)
-  [Broadcom Limited Information](#)

Optimize Your Supply Chain with WIN SOURCE Solutions

-  Global Sourcing Solution
-  Obsolete Management
-  Cost Control Management
-  Shortage Management
-  Alternative Solution
-  Excess Inventory Management