



THE DATASHEET OF MCR68-002



MCR68-2

Silicon Controlled Rectifiers Reverse Blocking Thyristors

Designed for overvoltage protection in crowbar circuits.

Features

- Glass-Passivated Junctions for Greater Parameter Stability and Reliability
- Center-Gate Geometry for Uniform Current Spreading Enabling High Discharge Current
- Small Rugged, Thermowatt Package Constructed for Low Thermal Resistance and Maximum Power Dissipation and Durability
- High Capacitor Discharge Current, 300 Amps
- Pb-Free Package is Available*

MAXIMUM RATINGS (T_J = 25°C unless otherwise noted)

Rating	Symbol	Value	Unit
Peak Repetitive Off-State Voltage (Note 1) (T _J = -40 to +125°C, Gate Open) MCR68-2	V _{DRM} , V _{RPM}	50	V
Peak Discharge Current (Note 2)	I _{TM}	300	A
On-State RMS Current (180° Conduction Angles; T _C = 85°C)	I _{T(RMS)}	12	A
Average On-State Current (180° Conduction Angles; T _C = 85°C)	I _{T(AV)}	8.0	A
Peak Non-Repetitive Surge Current (1/2 Cycle, Sine Wave, 60 Hz, T _J = 125°C)	I _{TSM}	100	A
Circuit Fusing Considerations (t = 8.3 ms)	I ² t	40	A ² s
Forward Peak Gate Current (t ≤ 1.0 μs, T _C = 85°C)	I _{GM}	2.0	A
Forward Peak Gate Power (t ≤ 1.0 μs, T _C = 85°C)	P _{GM}	20	W
Forward Average Gate Power (t = 8.3 ms, T _C = 85°C)	P _{G(AV)}	0.5	W
Operating Junction Temperature Range	T _J	-40 to +125	°C
Storage Temperature Range	T _{stg}	-40 to +150	°C
Mounting Torque	-	8.0	in. lb.

Maximum ratings are those values beyond which device damage can occur. Maximum ratings applied to the device are individual stress limit values (not normal operating conditions) and are not valid simultaneously. If these limits are exceeded, device functional operation is not implied, damage may occur and reliability may be affected.

1. V_{DRM} and V_{RPM} for all types can be applied on a continuous basis. Ratings apply for zero or negative gate voltage; however, positive gate voltage shall not be applied concurrent with negative potential on the anode. Blocking voltages shall not be tested with a constant current source such that the voltage ratings of the devices are exceeded.
2. Ratings apply for t_w = 1 ms. See Figure 1 for I_{TM} capability for various duration of an exponentially decaying current waveform, t_w is defined as 5 time constants of an exponentially decaying current pulse.

*For additional information on our Pb-Free strategy and soldering details, please download the ON Semiconductor Soldering and Mounting Techniques Reference Manual, SOLDERRM/D.



ON Semiconductor®

<http://onsemi.com>

SCRs
12 AMPERES RMS
50 VOLTS



MARKING DIAGRAM

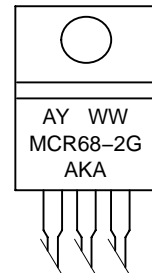
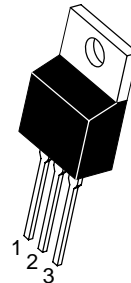

TO-220AB
CASE 221A-07
STYLE 3

- A = Assembly Location
- Y = Year
- WW = Work Week
- G = Pb-Free Package
- AKA = Diode Polarity

PIN ASSIGNMENT

Pin	Assignment
1	Cathode
2	Anode
3	Gate
4	Anode

ORDERING INFORMATION

Device	Package	Shipping
MCR68-2	TO-220AB	500 Units / Box
MCR68-2G	TO-220AB (Pb-Free)	500 Units / Box

Preferred devices are recommended choices for future use and best overall value.

MCR68-2

Thermal Characteristics

Characteristic	Symbol	Max	Unit
Thermal Resistance, Junction-to-Case	$R_{\theta JC}$	2.0	$^{\circ}C/W$
Thermal Resistance, Junction-to-Ambient	$R_{\theta JA}$	60	$^{\circ}C/W$
Maximum Lead Temperature for Soldering Purposes 1/8" from Case for 10 Seconds	T_L	260	$^{\circ}C$

Electrical Characteristics ($T_C = 25^{\circ}C$ unless otherwise noted.)

Characteristic	Symbol	Min	Typ	Max	Unit
----------------	--------	-----	-----	-----	------

OFF CHARACTERISTICS

Peak Repetitive Forward or Reverse Blocking Current ($V_{AK} = \text{Rated } V_{DRM} \text{ or } V_{RRM}, \text{ Gate Open}$)	I_{DRM}, I_{RRM}	-	-	10	μA
	$T_J = 25^{\circ}C$	-	-	2.0	μA
	$T_J = 125^{\circ}C$	-	-	2.0	μA

ON CHARACTERISTICS

Peak Forward On-State Voltage ($I_{TM} = 24 \text{ A}$) (Note 3) ($I_{TM} = 300 \text{ A}, t_w = 1 \text{ ms}$) (Note 4)	V_{TM}	-	-	2.2	V
		-	6.0	-	
Gate Trigger Current (Continuous dc) ($V_D = 12 \text{ V}, R_L = 100 \Omega$)	I_{GT}	2.0	7.0	30	mA
Gate Trigger Voltage (Continuous dc) ($V_D = 12 \text{ V}, R_L = 100 \Omega$)	V_{GT}	-	0.65	1.5	V
Gate Non-Trigger Voltage ($V_D = 12 \text{ Vdc}, R_L = 100 \Omega, T_J = 125^{\circ}C$)	V_{GD}	0.2	0.40	-	V
Holding Current ($V_D = 12 \text{ V}, \text{ Initiating Current} = 200 \text{ mA}, \text{ Gate Open}$)	I_H	3.0	15	50	mA
Latching Current ($V_D = 12 \text{ Vdc}, I_G = 150 \text{ mA}$)	I_L	-	-	60	mA
Gate Controlled Turn-On Time (Note 5) ($V_D = \text{Rated } V_{DRM}, I_G = 150 \text{ mA}$) ($I_{TM} = 24 \text{ A Peak}$)	t_{gt}	-	1.0	-	μs

DYNAMIC CHARACTERISTICS

Critical Rate-of-Rise of Off-State Voltage ($V_D = \text{Rated } V_{DRM}, \text{ Gate Open}, \text{ Exponential Waveform}, T_J = 125^{\circ}C$)	dv/dt	10	-	-	$V/\mu s$
Critical Rate-of-Rise of On-State Current $I_G = 150 \text{ mA}$	di/dt	-	-	75	$A/\mu s$
					$T_J = 125^{\circ}C$

3. Pulse duration $\leq 300 \mu s$, duty cycle $\leq 2\%$.
4. Ratings apply for $t_w = 1 \text{ ms}$. See Figure 1 for I_{TM} capability for various durations of an exponentially decaying current waveform. t_w is defined as 5 time constants of an exponentially decaying current pulse.
5. The gate controlled turn-on time in a crowbar circuit will be influenced by the circuit inductance.

Voltage Current Characteristic of SCR

Symbol	Parameter
V_{DRM}	Peak Repetitive Off State Forward Voltage
I_{DRM}	Peak Forward Blocking Current
V_{RRM}	Peak Repetitive Off State Reverse Voltage
I_{RRM}	Peak Reverse Blocking Current
V_{TM}	Peak On State Voltage
I_H	Holding Current

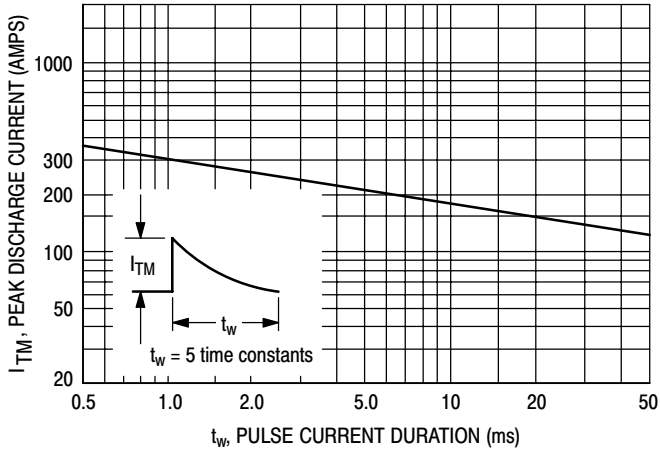
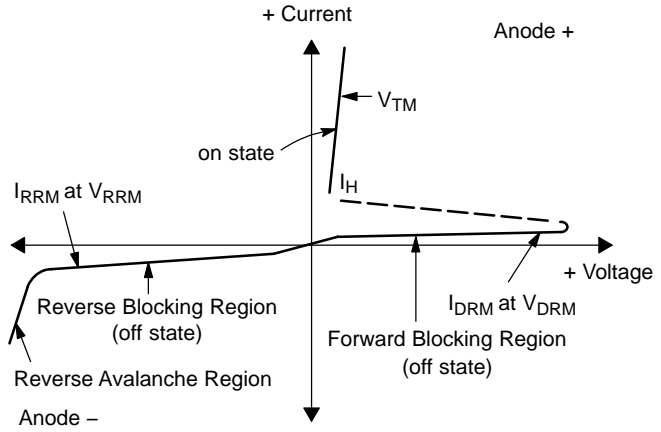

Figure 1. Peak Capacitor Discharge Current

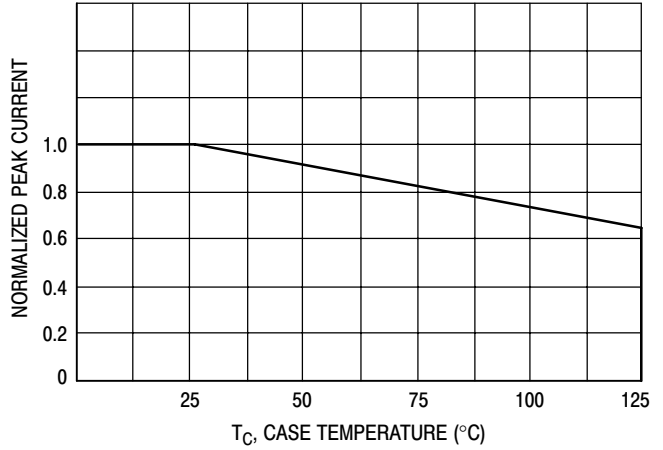

Figure 2. Peak Capacitor Discharge Current Derating

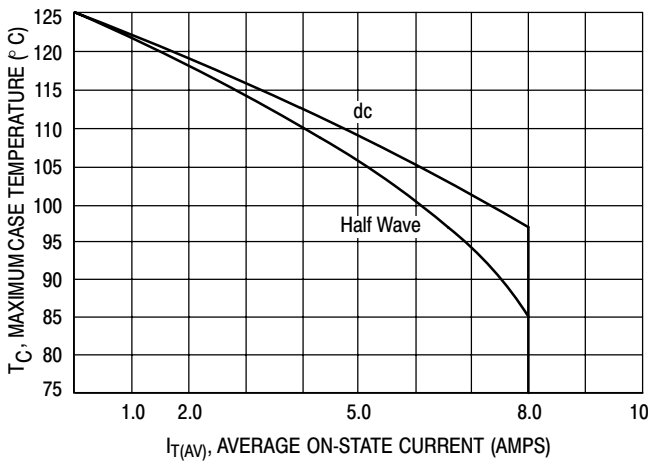

Figure 3. Current Derating

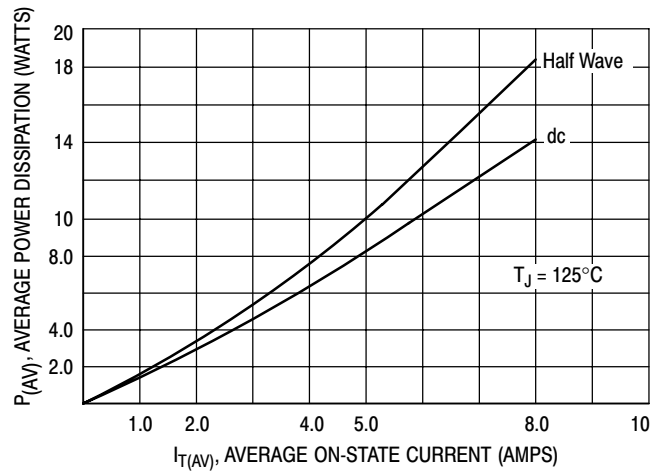

Figure 4. Maximum Power Dissipation

MCR68-2

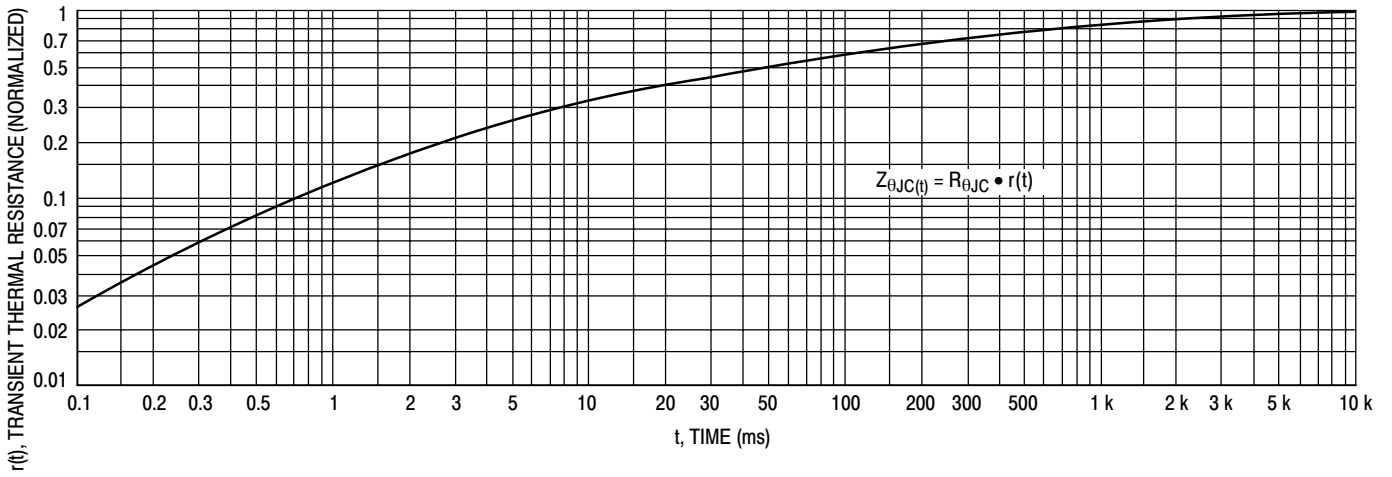

Figure 5. Thermal Response

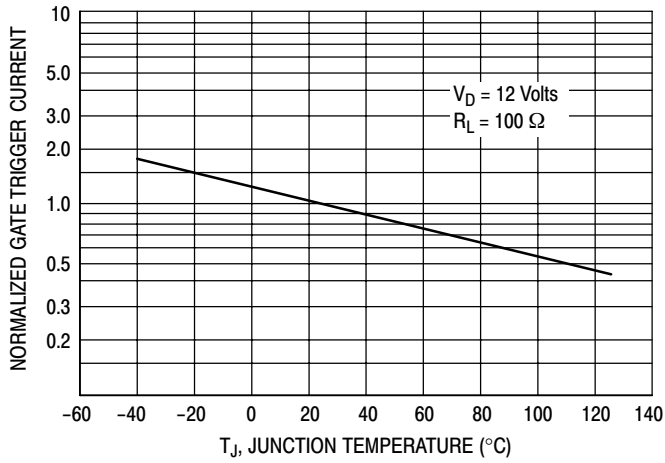

Figure 6. Gate Trigger Current

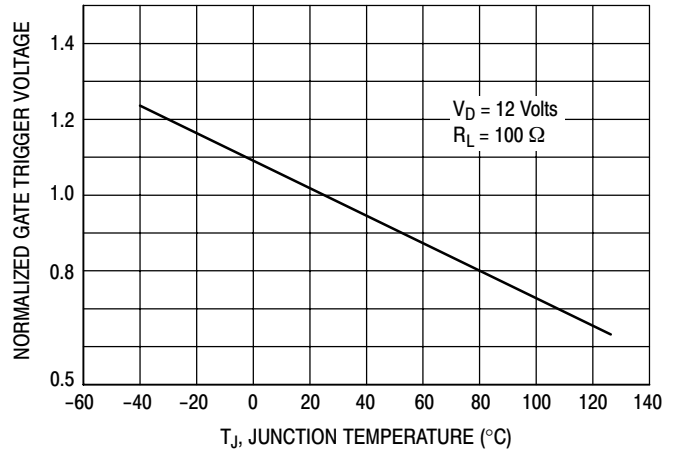

Figure 7. Gate Trigger Voltage

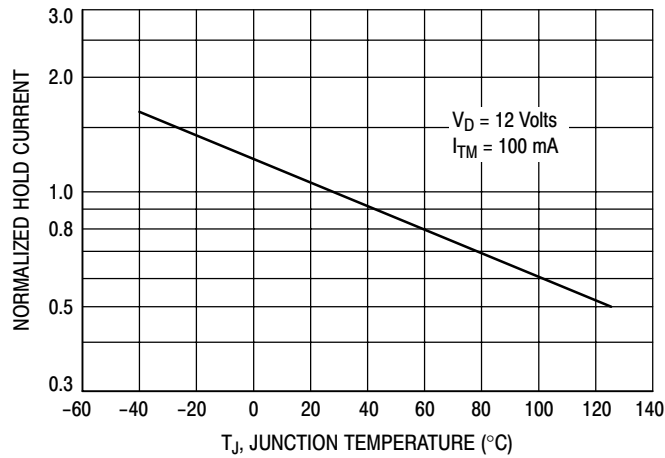
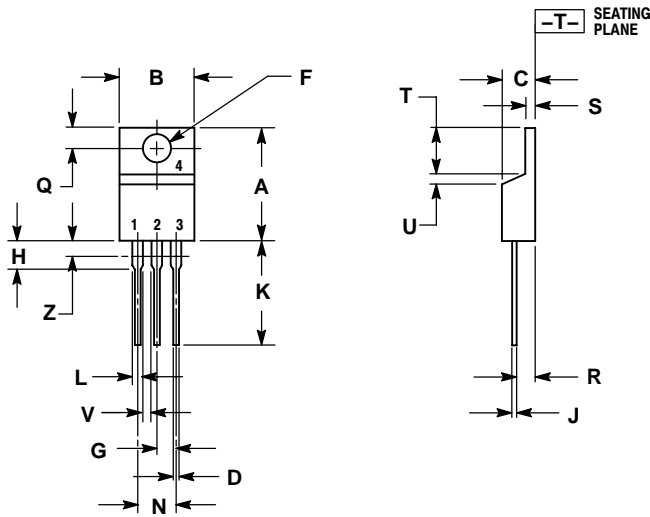

Figure 8. Holding Current

MCR68-2

PACKAGE DIMENSIONS

TO-220AB
CASE 221A-07
ISSUE AA



- NOTES:
1. DIMENSIONING AND TOLERANCING PER ANSI Y14.5M, 1982.
 2. CONTROLLING DIMENSION: INCH.
 3. DIMENSION Z DEFINES A ZONE WHERE ALL BODY AND LEAD IRREGULARITIES ARE ALLOWED.

DIM	INCHES		MILLIMETERS	
	MIN	MAX	MIN	MAX
A	0.570	0.620	14.48	15.75
B	0.380	0.405	9.66	10.28
C	0.160	0.190	4.07	4.82
D	0.025	0.035	0.64	0.88
F	0.142	0.147	3.61	3.73
G	0.095	0.105	2.42	2.66
H	0.110	0.155	2.80	3.93
J	0.014	0.022	0.36	0.55
K	0.500	0.562	12.70	14.27
L	0.045	0.060	1.15	1.52
N	0.190	0.210	4.83	5.33
Q	0.100	0.120	2.54	3.04
R	0.080	0.110	2.04	2.79
S	0.045	0.055	1.15	1.39
T	0.235	0.255	5.97	6.47
U	0.000	0.050	0.00	1.27
V	0.045	---	1.15	---
Z	---	0.080	---	2.04

- STYLE 3:
PIN 1. CATHODE
2. ANODE
3. GATE
4. ANODE

ON Semiconductor and are registered trademarks of Semiconductor Components Industries, LLC (SCILLC). SCILLC reserves the right to make changes without further notice to any products herein. SCILLC makes no warranty, representation or guarantee regarding the suitability of its products for any particular purpose, nor does SCILLC assume any liability arising out of the application or use of any product or circuit, and specifically disclaims any and all liability, including without limitation special, consequential or incidental damages. "Typical" parameters which may be provided in SCILLC data sheets and/or specifications can and do vary in different applications and actual performance may vary over time. All operating parameters, including "Typicals" must be validated for each customer application by customer's technical experts. SCILLC does not convey any license under its patent rights nor the rights of others. SCILLC products are not designed, intended, or authorized for use as components in systems intended for surgical implant into the body, or other applications intended to support or sustain life, or for any other application in which the failure of the SCILLC product could create a situation where personal injury or death may occur. Should Buyer purchase or use SCILLC products for any such unintended or unauthorized application, Buyer shall indemnify and hold SCILLC and its officers, employees, subsidiaries, affiliates, and distributors harmless against all claims, costs, damages, and expenses, and reasonable attorney fees arising out of, directly or indirectly, any claim of personal injury or death associated with such unintended or unauthorized use, even if such claim alleges that SCILLC was negligent regarding the design or manufacture of the part. SCILLC is an Equal Opportunity/Affirmative Action Employer. This literature is subject to all applicable copyright laws and is not for resale in any manner.

PUBLICATION ORDERING INFORMATION

LITERATURE FULFILLMENT:
Literature Distribution Center for ON Semiconductor
P.O. Box 61312, Phoenix, Arizona 85082-1312 USA
Phone: 480-829-7710 or 800-344-3860 Toll Free USA/Canada
Fax: 480-829-7709 or 800-344-3867 Toll Free USA/Canada
Email: orderlit@onsemi.com

N. American Technical Support: 800-282-9855 Toll Free
USA/Canada

Japan: ON Semiconductor, Japan Customer Focus Center
2-9-1 Kamimeguro, Meguro-ku, Tokyo, Japan 153-0051
Phone: 81-3-5773-3850

ON Semiconductor Website: <http://onsemi.com>

Order Literature: <http://www.onsemi.com/litorder>

For additional information, please contact your local Sales Representative.

Looking for pricing, stock, or lifecycle information?

Click below to explore more details on WIN SOURCE:

- ⊖ [View MCR68-002 on WIN SOURCE](#)
- ⊖ [ON Semiconductor Information](#)

Optimize Your Supply Chain with WIN SOURCE Solutions

- ✓ Global Sourcing Solution
- ✓ Obsolete Management
- ✓ Cost Control Management
- ✓ Shortage Management
- ✓ Alternative Solution
- ✓ Excess Inventory Management