



**THE DATASHEET OF  
MC9S08PA4AVWJ**



# MC9S08PA4

## MC9S08PA4 Data Sheet

Supports: MC9S08PA4(A)

### Key features

- 8-Bit S08 central processor unit (CPU)
  - Up to 20 MHz bus at 2.7 V to 5.5 V across operating temperature range
  - Supporting up to 40 interrupt/reset sources
  - Supporting up to four-level nested interrupt
  - On-chip memory
  - Up to 4 KB flash read/program/erase over full operating voltage and temperature
  - Up to 128 byte EEPROM; 2-byte erase sector; program and erase while executing flash
  - Up to 512 byte random-access memory (RAM)
  - Flash and RAM access protection
- Power-saving modes
  - One low-power stop mode; reduced power wait mode
  - Peripheral clock enable register can disable clocks to unused modules, reducing currents; allows clocks to remain enabled to specific peripherals in stop3 mode
- Clocks
  - Oscillator (XOSC) - loop-controlled Pierce oscillator; crystal or ceramic resonator range of 31.25 kHz to 39.0625 kHz or 4 MHz to 20 MHz
  - Internal clock source (ICS) - containing a frequency-locked-loop (FLL) controlled by internal or external reference; precision trimming of internal reference allowing 1% deviation across temperature range of 0 °C to 70 °C and 2% deviation across whole operating temperature range; up to 20 MHz
- System protection
  - Watchdog with independent clock source
  - Low-voltage detection with reset or interrupt; selectable trip points
  - Illegal opcode detection with reset
  - Illegal address detection with reset
- Development support
  - Single-wire background debug interface
  - Breakpoint capability to allow three breakpoints setting during in-circuit debugging
  - On-chip in-circuit emulator (ICE) debug module containing two comparators and nine trigger modes
- Peripherals
  - ACMP - one analog comparator with both positive and negative inputs; separately selectable interrupt on rising and falling comparator output; filtering
  - ADC - 8-channel, 12-bit resolution; 2.5 μs conversion time; data buffers with optional watermark; automatic compare function; internal bandgap reference channel; operation in stop mode; optional hardware trigger
  - FTM - Three 2-channel flex timer modulators modules; 16-bit counter; each channel can be configured for input capture, output compare, edge- or center-aligned PWM mode
  - RTC - 16-bit real timer counter (RTC)
  - SCI - one serial communication interface (SCI/UART) modules optional 13-bit break; full duplex non-return to zero (NRZ); LIN extension support
- Input/Output
  - Up to 18 GPIOs including one output-only pin
  - One 8-bit keyboard interrupt module (KBI)
  - Two, ultra-high current sink pins supporting 20 mA source/sink current
- Package options
  - 20-pin SOIC
  - 20-pin TSSOP
  - 16-pin TSSOP
  - 8-pin DFN
  - 8-pin SOIC

# Table of Contents

1	MCU block diagram.....	3	6.2	Switching specifications.....	16
2	Orderable part numbers.....	4	6.2.1	Control timing.....	16
3	Part identification.....	4	6.2.2	Debug trace timing specifications.....	17
3.1	Description.....	4	6.2.3	FTM module timing.....	18
3.2	Format.....	4	6.3	Thermal specifications.....	19
3.3	Fields.....	5	6.3.1	Thermal characteristics.....	19
3.4	Example.....	5	7	Peripheral operating requirements and behaviors.....	20
4	Parameter Classification.....	5	7.1	External oscillator (XOSC) and ICS characteristics.....	20
5	Ratings.....	6	7.2	NVM specifications.....	21
5.1	Thermal handling ratings.....	6	7.3	Analog.....	23
5.2	Moisture handling ratings.....	6	7.3.1	ADC characteristics.....	23
5.3	ESD handling ratings.....	6	7.3.2	Analog comparator (ACMP) electricals.....	25
5.4	Voltage and current operating ratings.....	7	8	Dimensions.....	26
6	General.....	8	8.1	Obtaining package dimensions.....	26
6.1	Nonswitching electrical specifications.....	8	9	Pinout.....	26
6.1.1	DC characteristics.....	8	9.1	Signal multiplexing and pin assignments.....	26
6.1.2	Supply current characteristics.....	14	9.2	Device pin assignment.....	27
6.1.3	EMC performance.....	15	10	Revision history.....	28

# 1 MCU block diagram

The block diagram below shows the structure of the MCUs.

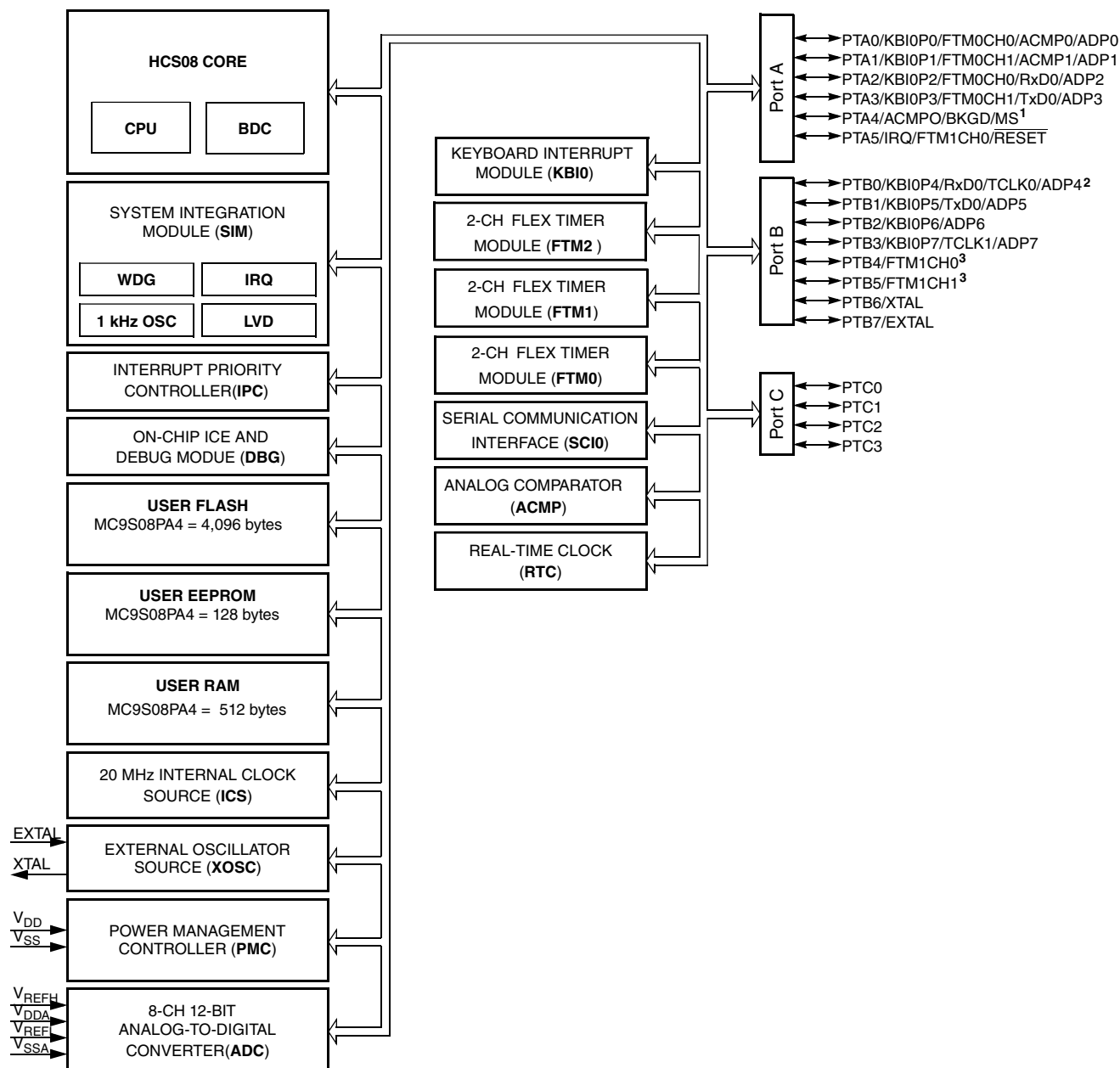

1. PTA4/ACMP0/BKGD/MS is an output-only pin when used as port pin.
2. PTB0 operates as true open drain when working as output.
3. PTB4 and PTB5 can provide high sink/source current drive.

Figure 1. MCU block diagram

## 2 Orderable part numbers

The following table summarizes the part numbers of the devices covered by this document.

**Table 1. Ordering information**

Feature	MC9S08PA4(A)				
	VWJ	VTJ	VTG	VSC	VDC
			MTG	MSC	
Max. frequency (MHz)	20	20	20	20	20
Flash memory (KB)	4	4	4	4	4
RAM (B)	512	512	512	512	512
EEPROM (B)	128	128	128	128	128
12-bit ADC	8ch	8ch	8ch	4ch	4ch
16-bit FlexTimer	2ch+2ch+2ch <sup>1</sup>	2ch+2ch+2ch <sup>1</sup>	2ch+2ch+2ch <sup>1</sup>	2ch+2ch+2ch <sup>1, 2</sup>	2ch+2ch+2ch <sup>1, 2</sup>
ACMP	1	1	1	1	1
RTC	Yes	Yes	Yes	Yes	Yes
SCI (LIN Capable)	1	1	1	1	1
Watchdog	Yes	Yes	Yes	Yes	Yes
20mA high-drive pins	2	2	2	-	-
KBI pins	8	8	8	4	4
GPIO	18	18	14	6	6
Package	20-SOIC	20-TSSOP	16-TSSOP	8-SOIC	8-DFN

1. FTM2 has no external pins available.
2. FTM1 channel 1 has no external pins available.

## 3 Part identification

### 3.1 Description

Part numbers for the chip have fields that identify the specific part. You can use the values of these fields to determine the specific part you have received.

### 3.2 Format

Part numbers for this device have the following format:

MC 9 S08 PA AA (V) B CC

### 3.3 Fields

This table lists the possible values for each field in the part number (not all combinations are valid):

Field	Description	Values
MC	Qualification status	<ul style="list-style-type: none"> <li>MC = fully qualified, general market flow</li> </ul>
9	Memory	<ul style="list-style-type: none"> <li>9 = flash based</li> </ul>
S08	Core	<ul style="list-style-type: none"> <li>S08 = 8-bit CPU</li> </ul>
PA	Device family	<ul style="list-style-type: none"> <li>PA</li> </ul>
AA	Approximate flash size in KB	<ul style="list-style-type: none"> <li>4 = 4 KB</li> </ul>
(V)	Mask set version	<ul style="list-style-type: none"> <li>(blank) = Any version<sup>1</sup></li> <li>A = Rev. 2 or later version, this is recommended for new design<sup>1</sup></li> </ul>
B	Operating temperature range (°C)	<ul style="list-style-type: none"> <li>M = -40 to 125</li> <li>V = -40 to 105</li> </ul>
CC	Package designator	<ul style="list-style-type: none"> <li>WJ = 20-SOIC</li> <li>TJ = 20-TSSOP</li> <li>TG = 16-TSSOP</li> <li>DC = 8-DFN</li> <li>SC = 8-SOIC</li> </ul>

1. From June 1, 2017, (blank) and A share the same mask set version.

### 3.4 Example

This is an example part number:

MC9S08PA4AVWJ

## 4 Parameter Classification

The electrical parameters shown in this supplement are guaranteed by various methods. To give the customer a better understanding, the following classification is used and the parameters are tagged accordingly in the tables where appropriate:

**Table 2. Parameter Classifications**

P	Those parameters are guaranteed during production testing on each individual device.
---	--

*Table continues on the next page...*

**Table 2. Parameter Classifications (continued)**

C	Those parameters are achieved by the design characterization by measuring a statistically relevant sample size across process variations.
T	Those parameters are achieved by design characterization on a small sample size from typical devices under typical conditions unless otherwise noted. All values shown in the typical column are within this category.
D	Those parameters are derived mainly from simulations.

**NOTE**

The classification is shown in the column labeled “C” in the parameter tables where appropriate.

## 5 Ratings

### 5.1 Thermal handling ratings

Symbol	Description	Min.	Max.	Unit	Notes
T <sub>STG</sub>	Storage temperature	-55	150	°C	1
T <sub>SDR</sub>	Solder temperature, lead-free	—	260	°C	2

1. Determined according to JEDEC Standard JESD22-A103, *High Temperature Storage Life*.
2. Determined according to IPC/JEDEC Standard J-STD-020, *Moisture/Reflow Sensitivity Classification for Nonhermetic Solid State Surface Mount Devices*.

### 5.2 Moisture handling ratings

Symbol	Description	Min.	Max.	Unit	Notes
MSL	Moisture sensitivity level	—	3	—	1

1. Determined according to IPC/JEDEC Standard J-STD-020, *Moisture/Reflow Sensitivity Classification for Nonhermetic Solid State Surface Mount Devices*.

### 5.3 ESD handling ratings

Symbol	Description	Min.	Max.	Unit	Notes
V <sub>HBM</sub>	Electrostatic discharge voltage, human body model	-6000	+6000	V	1
V <sub>CDM</sub>	Electrostatic discharge voltage, charged-device model	-500	+500	V	2
I <sub>LAT</sub>	Latch-up current at ambient temperature of 125 °C	-100	+100	mA	3

1. Determined according to JEDEC Standard JESD22-A114, *Electrostatic Discharge (ESD) Sensitivity Testing Human Body Model (HBM)*.
2. Determined according to JEDEC Standard JESD22-C101, *Field-Induced Charged-Device Model Test Method for Electrostatic-Discharge-Withstand Thresholds of Microelectronic Components*.
3. Determined according to JEDEC Standard JESD78D, IC Latch-up Test.
  - Test was performed at 125 °C case temperature (Class II).
  - I/O pins pass +100/-100 mA I-test with  $I_{DD}$  current limit at 200 mA.
  - I/O pins pass +20/-100 mA I-test with  $I_{DD}$  current limit at 1000mA.
  - Supply groups pass 1.5  $V_{CCmax}$ .
  - RESET pin was only tested with negative I-test due to product conditioning requirement.

## 5.4 Voltage and current operating ratings

Absolute maximum ratings are stress ratings only, and functional operation at the maxima is not guaranteed. Stress beyond the limits specified in below table may affect device reliability or cause permanent damage to the device. For functional operating conditions, refer to the remaining tables in this document.

This device contains circuitry protecting against damage due to high static voltage or electrical fields; however, it is advised that normal precautions be taken to avoid application of any voltages higher than maximum-rated voltages to this high-impedance circuit. Reliability of operation is enhanced if unused inputs are tied to an appropriate logic voltage level (for instance, either  $V_{SS}$  or  $V_{DD}$ ) or the programmable pullup resistor associated with the pin is enabled.

Symbol	Description	Min.	Max.	Unit
$V_{DD}$	Supply voltage	-0.3	6.0	V
$I_{DD}$	Maximum current into $V_{DD}$	—	120	mA
$V_{DIO}$	Digital input voltage (except $\overline{RESET}$ , EXTAL, XTAL, or true open drain pin PTB0)	-0.3	$V_{DD} + 0.3$	V
	Digital input voltage (true open drain pin PTB0)	-0.3	6	V
$V_{AIO}$	Analog <sup>1</sup> , $\overline{RESET}$ , EXTAL, and XTAL input voltage	-0.3	$V_{DD} + 0.3$	V
$I_D$	Instantaneous maximum current single pin limit (applies to all port pins)	-25	25	mA
$V_{DDA}$	Analog supply voltage	$V_{DD} - 0.3$	$V_{DD} + 0.3$	V

1. All digital I/O pins, except open-drain pin PTB0, are internally clamped to  $V_{SS}$  and  $V_{DD}$ . PTB0 is only clamped to  $V_{SS}$ .

## 6 General

### 6.1 Nonswitching electrical specifications

#### 6.1.1 DC characteristics

This section includes information about power supply requirements and I/O pin characteristics.

**Table 3. DC characteristics**

Symbol	C	Descriptions		Min	Typical <sup>1</sup>	Max	Unit
—	—	Operating voltage		—	2.7	—	5.5 V
V <sub>OH</sub>	C	Output high voltage	All I/O pins, standard-drive strength	5 V, I <sub>load</sub> = -5 mA	V <sub>DD</sub> - 0.8	—	— V
				3 V, I <sub>load</sub> = -2.5 mA	V <sub>DD</sub> - 0.8	—	— V
	C	High current drive pins, high-drive strength <sup>2</sup>	5 V, I <sub>load</sub> = -20 mA	V <sub>DD</sub> - 0.8	—	— V	
			3 V, I <sub>load</sub> = -10 mA	V <sub>DD</sub> - 0.8	—	— V	
I <sub>OHT</sub>	D	Output high current	Max total I <sub>OH</sub> for all ports	5 V	—	—	-100 mA
				3 V	—	—	-50
V <sub>OL</sub>	C	Output low voltage	All I/O pins, standard-drive strength	5 V, I <sub>load</sub> = 5 mA	—	—	0.8 V
				3 V, I <sub>load</sub> = 2.5 mA	—	—	0.8 V
	C	High current drive pins, high-drive strength <sup>2</sup>	5 V, I <sub>load</sub> = 20 mA	—	—	0.8 V	
			3 V, I <sub>load</sub> = 10 mA	—	—	0.8 V	
I <sub>OLT</sub>	D	Output low current	Max total I <sub>OL</sub> for all ports	5 V	—	—	100 mA
				3 V	—	—	50
V <sub>IH</sub>	P	Input high voltage	All digital inputs	V <sub>DD</sub> > 4.5V	0.70 × V <sub>DD</sub>	—	— V
	C			V <sub>DD</sub> > 2.7V	0.75 × V <sub>DD</sub>	—	—
V <sub>IL</sub>	P	Input low voltage	All digital inputs	V <sub>DD</sub> > 4.5V	—	—	0.30 × V <sub>DD</sub> V
	C			V <sub>DD</sub> > 2.7V	—	—	0.35 × V <sub>DD</sub>
V <sub>hys</sub>	C	Input hysteresis	All digital inputs	—	0.06 × V <sub>DD</sub>	—	mV
I <sub>IN</sub>	P	Input leakage current	All input only pins (per pin)	V <sub>IN</sub> = V <sub>DD</sub> or V <sub>SS</sub>	—	0.1	1 μA

Table continues on the next page...

**Table 3. DC characteristics (continued)**

Symbol	C	Descriptions			Min	Typical <sup>1</sup>	Max	Unit
I <sub>OZ</sub>	P	Hi-Z (off-state) leakage current	All input/output (per pin)	V <sub>IN</sub> = V <sub>DD</sub> or V <sub>SS</sub>	—	0.1	1	μA
I <sub>OZTOT</sub>	C	Total leakage combined for all inputs and Hi-Z pins	All input only and I/O	V <sub>IN</sub> = V <sub>DD</sub> or V <sub>SS</sub>	—	—	2	μA
R <sub>PU</sub>	P	Pullup resistors	All digital inputs, when enabled (all I/O pins other than PTB0)	—	30.0	—	50.0	kΩ
R <sub>PU</sub> <sup>3</sup>	P	Pullup resistors	PTB0 pin	—	30.0	—	60.0	kΩ
I <sub>IC</sub>	D	DC injection current <sup>4, 5, 6</sup>	Single pin limit	V <sub>IN</sub> < V <sub>SS</sub> , V <sub>IN</sub> > V <sub>DD</sub>	-0.2	—	2	mA
			Total MCU limit, includes sum of all stressed pins		-5	—	25	
C <sub>in</sub>	C	Input capacitance, all pins			—	—	7	pF
V <sub>RAM</sub>	C	RAM retention voltage			—	2.0	—	V

1. Typical values are measured at 25 °C. Characterized, not tested.
2. Only PTB4, PTB5 support ultra high current output.
3. The specified resistor value is the actual value internal to the device. The pullup value may appear higher when measured externally on the pin.
4. All functional non-supply pins, except for PTB0, are internally clamped to V<sub>SS</sub> and V<sub>DD</sub>.
5. Input must be current-limited to the value specified. To determine the value of the required current-limiting resistor, calculate resistance values for positive and negative clamp voltages, then use the large one.
6. Power supply must maintain regulation within operating V<sub>DD</sub> range during instantaneous and operating maximum current conditions. If the positive injection current (V<sub>in</sub> > V<sub>DD</sub>) is higher than I<sub>DD</sub>, the injection current may flow out of V<sub>DD</sub> and could result in external power supply going out of regulation. Ensure that external V<sub>DD</sub> load will shunt current higher than maximum injection current when the MCU is not consuming power, such as no system clock is present, or clock rate is very low (which would reduce overall power consumption).

**Table 4. LVD and POR Specification**

Symbol	C	Description		Min	Typ	Max	Unit
V <sub>POR</sub>	D	POR re-arm voltage <sup>1, 2</sup>		1.5	1.75	2.0	V
V <sub>LVDH</sub>	C	Falling low-voltage detect threshold - high range (LVDV = 1) <sup>3</sup>		4.2	4.3	4.4	V
V <sub>LWV1H</sub>	C	Falling low-voltage warning threshold - high range	Level 1 falling (LVWV = 00)	4.3	4.4	4.5	V
V <sub>LWV2H</sub>	C		Level 2 falling (LVWV = 01)	4.5	4.5	4.6	V
V <sub>LWV3H</sub>	C		Level 3 falling (LVWV = 10)	4.6	4.6	4.7	V
V <sub>LWV4H</sub>	C		Level 4 falling (LVWV = 11)	4.7	4.7	4.8	V
V <sub>HYSH</sub>	C	High range low-voltage detect/warning hysteresis		—	100	—	mV

Table continues on the next page...

**Table 4. LVD and POR Specification (continued)**

Symbol	C	Description	Min	Typ	Max	Unit	
V <sub>LVDL</sub>	C	Falling low-voltage detect threshold - low range (LVDV = 0)	2.56	2.61	2.66	V	
V <sub>LVDW1L</sub>	C	Falling low-voltage warning threshold - low range	Level 1 falling (LVWV = 00)	2.62	2.7	2.78	V
V <sub>LVDW2L</sub>	C		Level 2 falling (LVWV = 01)	2.72	2.8	2.88	V
V <sub>LVDW3L</sub>	C		Level 3 falling (LVWV = 10)	2.82	2.9	2.98	V
V <sub>LVDW4L</sub>	C		Level 4 falling (LVWV = 11)	2.92	3.0	3.08	V
V <sub>HYSDL</sub>	C	Low range low-voltage detect hysteresis	—	40	—	mV	
V <sub>HYSWL</sub>	C	Low range low-voltage warning hysteresis	—	80	—	mV	
V <sub>BG</sub>	P	Buffered bandgap output <sup>4</sup>	1.14	1.16	1.18	V	

1. Maximum is highest voltage that POR is guaranteed.
2. POR ramp time must be longer than 20us/V to get a stable startup.
3. Rising thresholds are falling threshold + hysteresis.
4. Voltage factory trimmed at V<sub>DD</sub> = 5.0 V, Temp = 25 °C

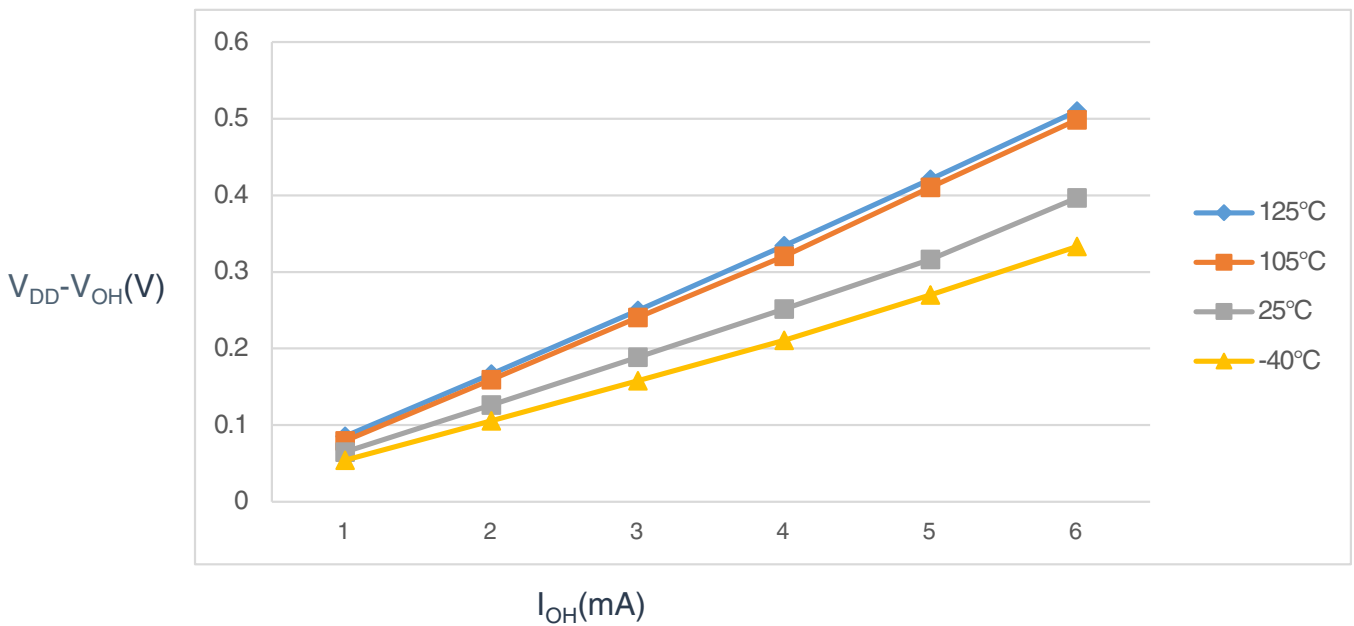

**Figure 2. Typical I<sub>OH</sub> Vs. V<sub>DD</sub>-V<sub>OH</sub> (standard drive strength) (V<sub>DD</sub> = 5 V)**

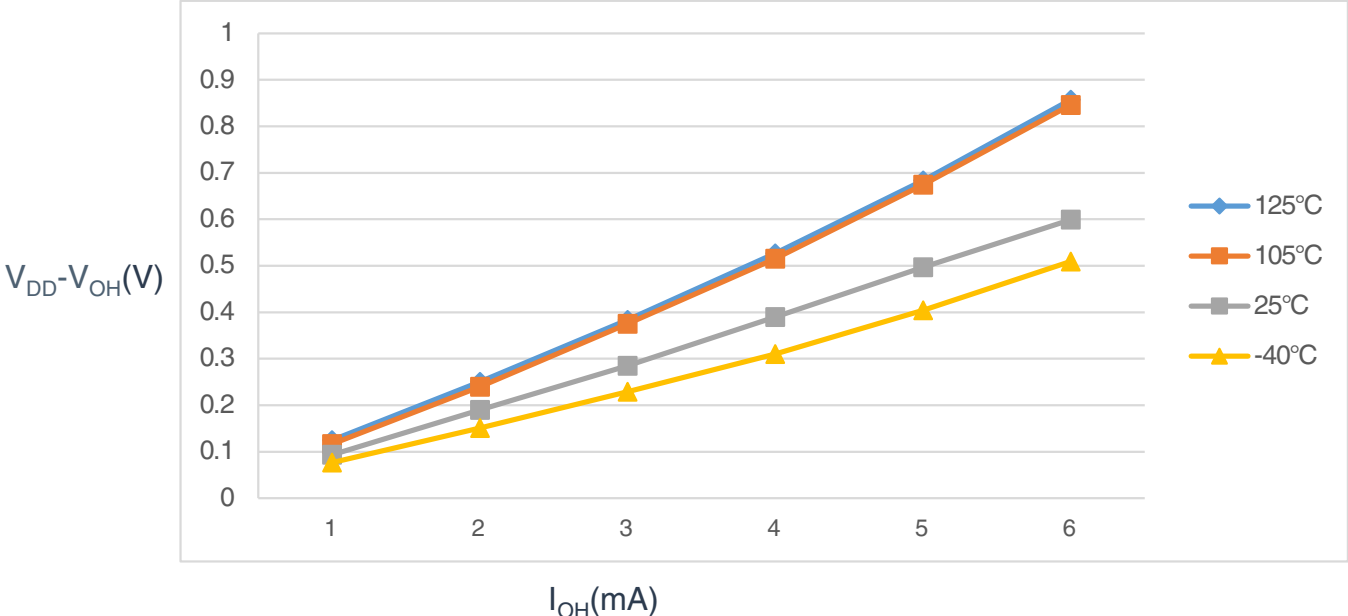

Figure 3. Typical  $I_{OH}$  Vs.  $V_{DD}-V_{OH}$  (standard drive strength) ( $V_{DD} = 3\text{ V}$ )

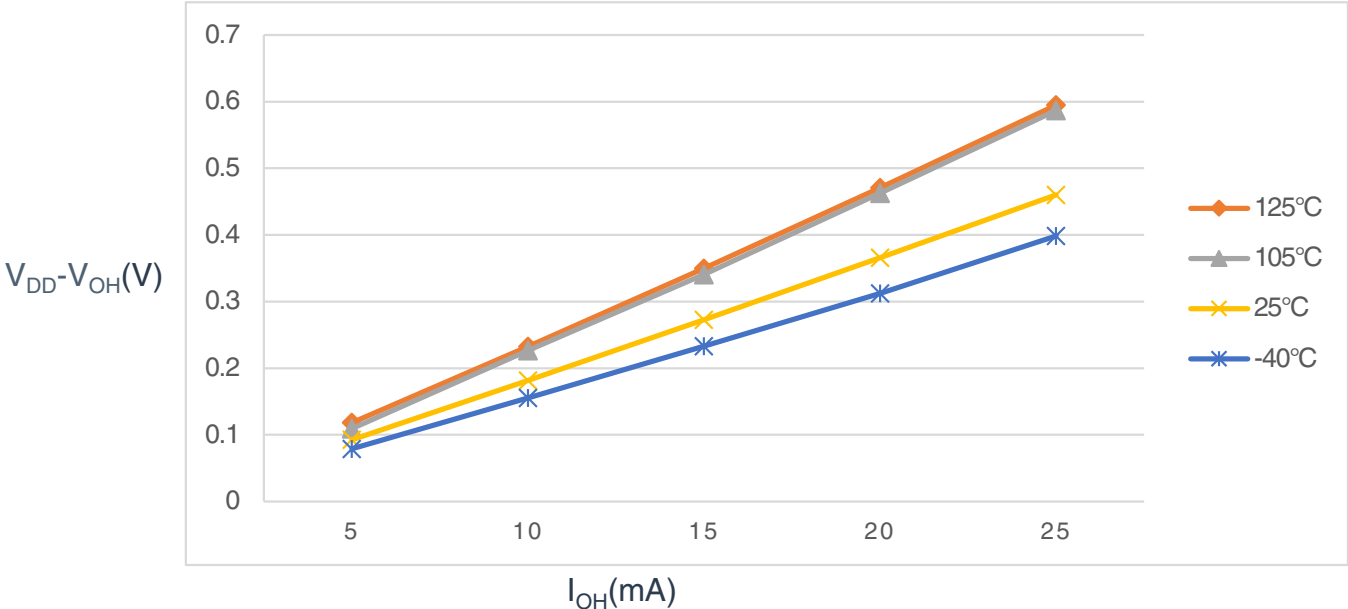

Figure 4. Typical  $I_{OH}$  Vs.  $V_{DD}-V_{OH}$  (high drive strength) ( $V_{DD} = 5\text{ V}$ )

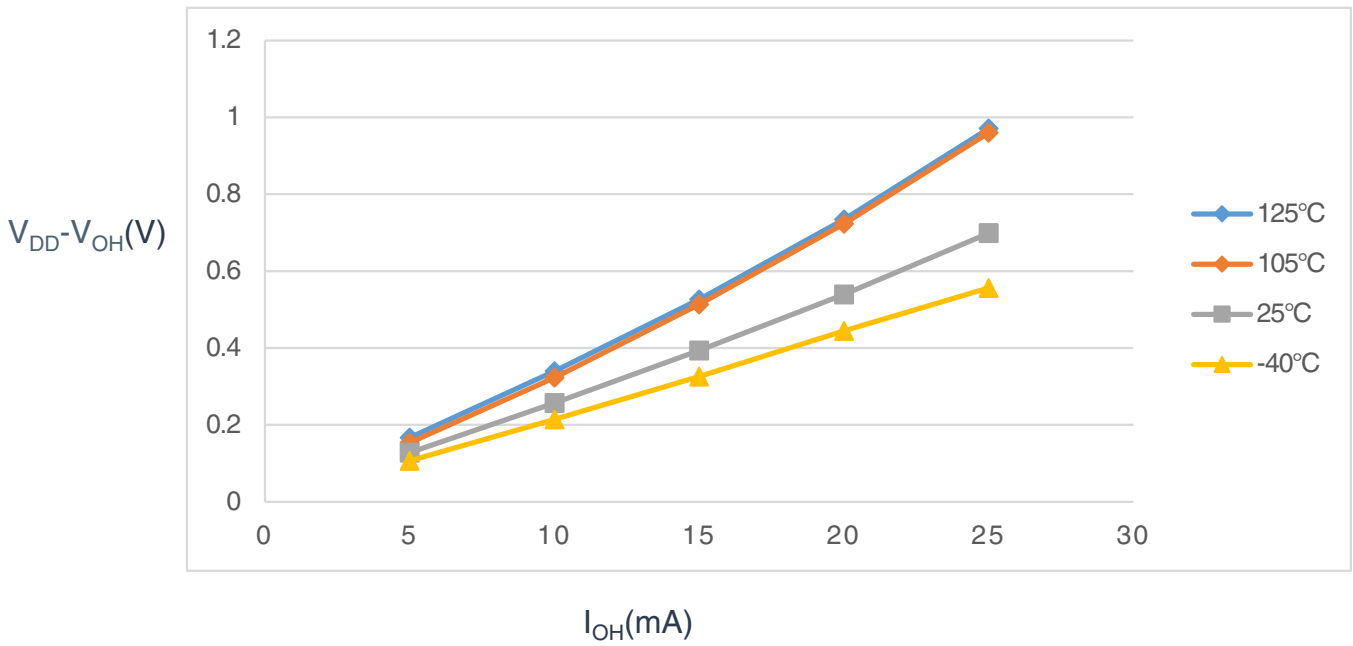

Figure 5. Typical  $I_{OH}$  Vs.  $V_{DD} - V_{OH}$  (high drive strength) ( $V_{DD} = 3$  V)

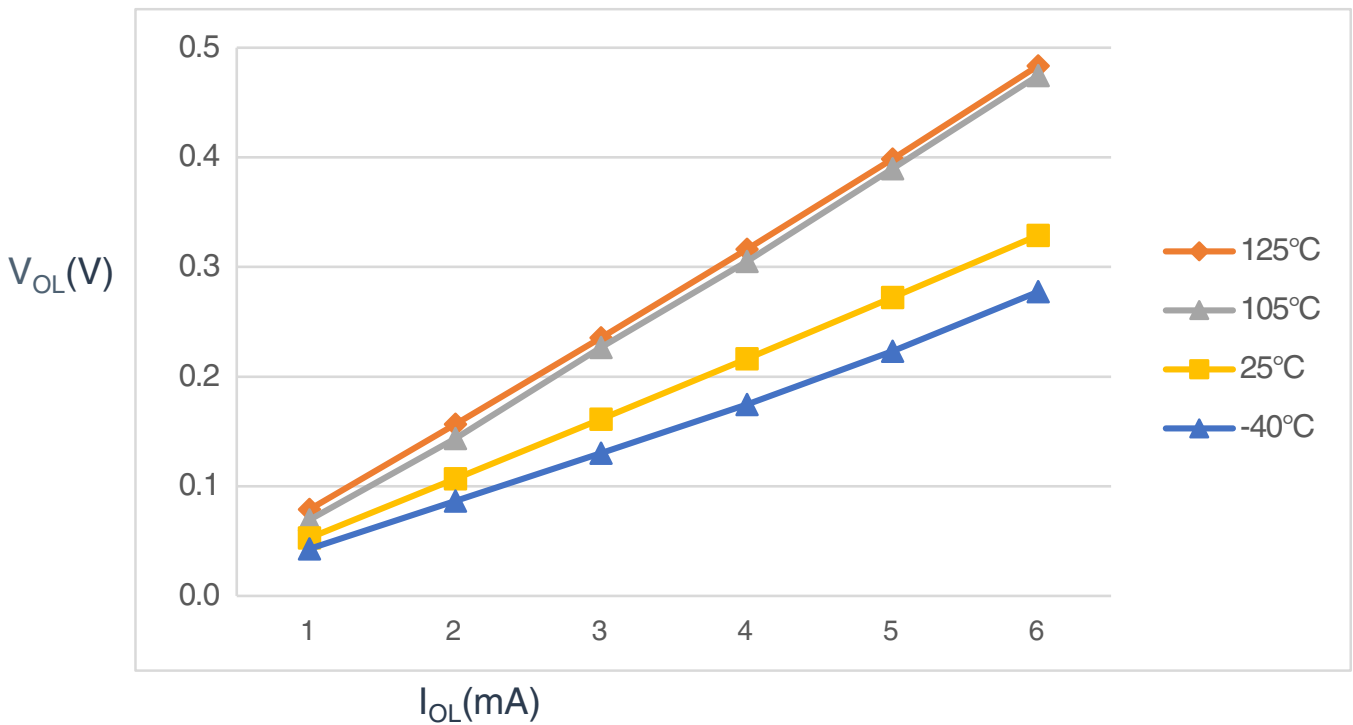

Figure 6. Typical  $I_{OL}$  Vs.  $V_{OL}$  (standard drive strength) ( $V_{DD} = 5$  V)

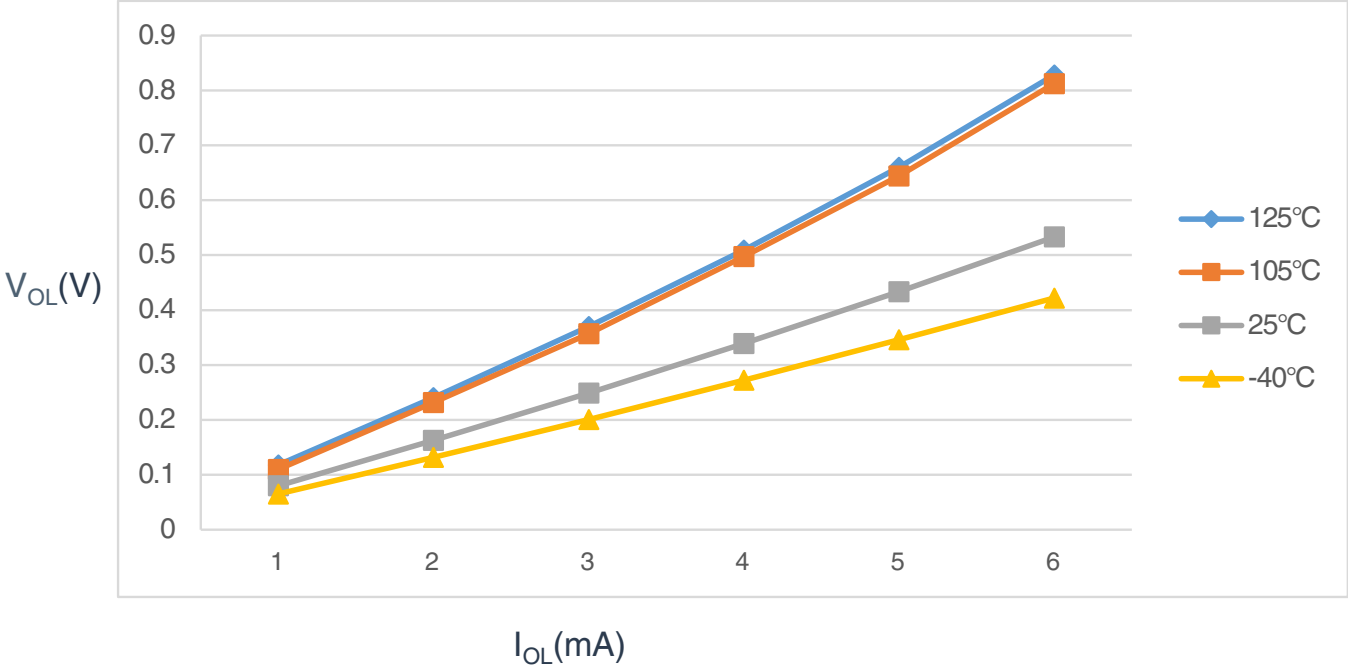

Figure 7. Typical  $I_{OL}$  Vs.  $V_{OL}$  (standard drive strength) ( $V_{DD} = 3\text{ V}$ )

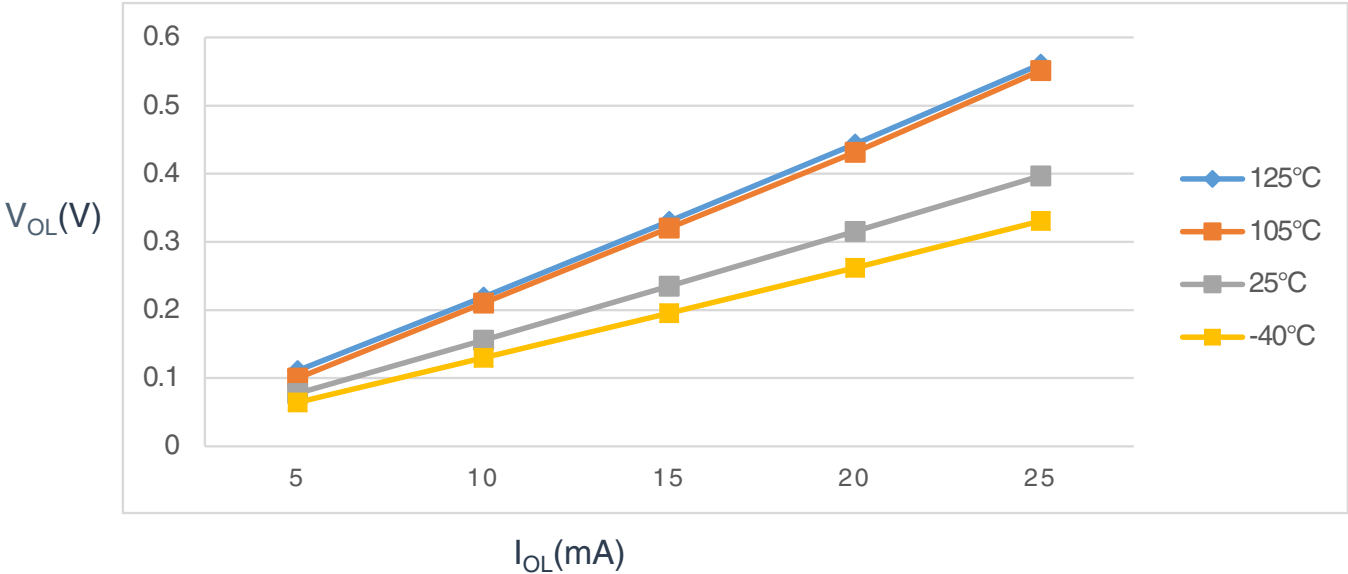

Figure 8. Typical  $I_{OL}$  Vs.  $V_{OL}$  (high drive strength) ( $V_{DD} = 5\text{ V}$ )

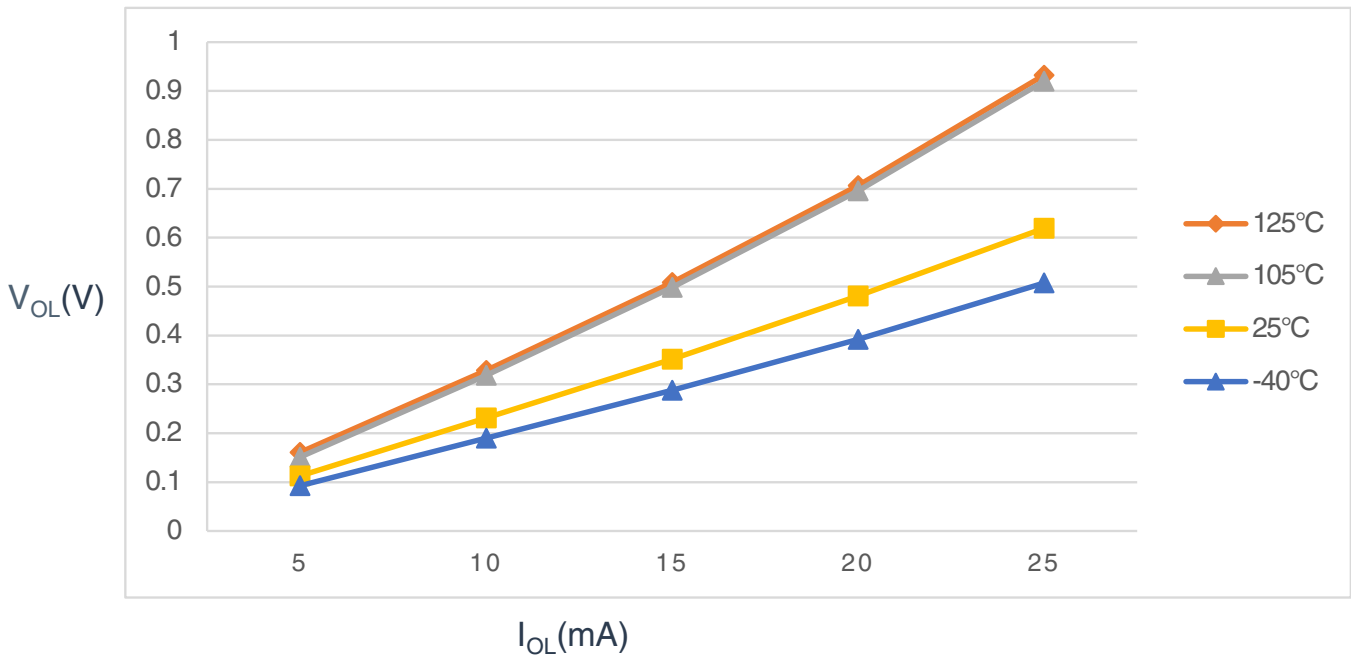

Figure 9. Typical  $I_{OL}$  Vs.  $V_{OL}$  (high drive strength) ( $V_{DD} = 3\text{ V}$ )

### 6.1.2 Supply current characteristics

This section includes information about power supply current in various operating modes.

Table 5. Supply current characteristics in operating temperature range

Num	C	Parameter	Symbol	Bus Freq	$V_{DD}$ (V)	Typical <sup>1</sup>	Max	Unit
1	C	Run supply current FEI mode, all modules on; run from flash	$R_{I_{DD}}$	20 MHz	5	5.43	—	mA
	C			10 MHz		3.46	—	
	C			1 MHz		1.71	—	
	C			20 MHz	3	5.35	—	
	C			10 MHz		3.45	—	
	C			1 MHz		1.69	—	
2	C	Run supply current FEI mode, all modules off and gated; run from flash	$R_{I_{DD}}$	20 MHz	5	4.51	—	mA
	C			10 MHz		3.01	—	
	C			1 MHz		1.68	—	
	C			20 MHz	3	4.47	—	
	C			10 MHz		2.99	—	
	C			1 MHz		1.65	—	
3	P	Run supply current FBE mode, all modules on; run from RAM	$R_{I_{DD}}$	20 MHz	5	5.31	7.41	mA
	C			10 MHz		3.17	—	
	C			1 MHz		1.25	—	
	C			20 MHz	3	5.29	—	
	C			10 MHz		3.17	—	
	C			1 MHz		—	—	

Table continues on the next page...

**Table 5. Supply current characteristics in operating temperature range (continued)**

Num	C	Parameter	Symbol	Bus Freq	V <sub>DD</sub> (V)	Typical <sup>1</sup>	Max	Unit
4	P	Run supply current FBE mode, all modules off and gated; run from RAM	R <sub>I</sub> DD	1 MHz	5	1.24	—	mA
	C			20 MHz		4.39	6.59	
				10 MHz		2.71	—	
	C			1 MHz	3	1.21	—	
				20 MHz		4.39	—	
				10 MHz		2.71	—	
5	C	Wait mode current FEI mode, all modules on	W <sub>I</sub> DD	20 MHz	5	3.62	—	mA
				10 MHz		2.27	—	
				1 MHz		1.11	—	
	C			20 MHz	3	3.61	—	
				10 MHz		2.31	—	
				1 MHz		1.10	—	
6	C	Stop3 mode supply current no clocks active (except 1 kHz LPO clock) <sup>2, 3</sup>	S <sub>3</sub> I <sub>DD</sub>	—	5	1.5	—	μA
	C			—	3	0.85	—	
7	C	ADC adder to stop3	—	—	5	96.0	—	μA
	C	ADLPC = 1 ADLSMP = 1 ADCO = 1 MODE = 10B ADICLK = 11B	—	—	3	88.3	—	
8	C	LVD adder to stop3 <sup>4</sup>	—	—	5	129	—	μA
	C				3	126	—	

1. Data in Typical column was characterized at 5.0 V, 25 °C or is typical recommended value.
2. RTC adder cause <1 μA I<sub>DD</sub> increase typically, RTC clock source is 1 kHz LPO clock.
3. ACMP adder cause <10 μA I<sub>DD</sub> increase typically.
4. LVD is periodically woken up from stop3 by 5% duty cycle. The period is equal to or less than 2 ms.

### 6.1.3 EMC performance

Electromagnetic compatibility (EMC) performance is highly dependent on the environment in which the MCU resides. Board design and layout, circuit topology choices, location and characteristics of external components as well as MCU software operation all play a significant role in EMC performance. The system designer should consult NXP applications notes such as [AN2321](#), [AN1050](#), [AN1263](#), [AN2764](#), and [AN1259](#) for advice and guidance specifically targeted at optimizing EMC performance.

### 6.1.3.1 EMC radiated emissions operating behaviors

**Table 6. EMC radiated emissions operating behaviors for 20-pin SOIC package**

Symbol	Description	Frequency band (MHz)	Typ.	Unit	Notes
V <sub>RE1</sub>	Radiated emissions voltage, band 1	0.15–50	7	dB $\mu$ V	1, 2
V <sub>RE2</sub>	Radiated emissions voltage, band 2	50–150	9	dB $\mu$ V	
V <sub>RE3</sub>	Radiated emissions voltage, band 3	150–500	8	dB $\mu$ V	
V <sub>RE4</sub>	Radiated emissions voltage, band 4	500–1000	5	dB $\mu$ V	
V <sub>RE_IEC</sub>	IEC level	0.15–1000	N	—	2, 3

1. Determined according to IEC Standard 61967-1, *Integrated Circuits - Measurement of Electromagnetic Emissions, 150 kHz to 1 GHz Part 1: General Conditions and Definitions* and IEC Standard 61967-2, *Integrated Circuits - Measurement of Electromagnetic Emissions, 150 kHz to 1 GHz Part 2: Measurement of Radiated Emissions—TEM Cell and Wideband TEM Cell Method*. Measurements were made while the microcontroller was running basic application code. The reported emission level is the value of the maximum measured emission, rounded up to the next whole number, from among the measured orientations in each frequency range.
2. V<sub>DD</sub> = 5.0 V, T<sub>A</sub> = 25 °C, f<sub>OSC</sub> = 10 MHz (crystal), f<sub>SYS</sub> = 20 MHz, f<sub>BUS</sub> = 20 MHz
3. Specified according to Annex D of IEC Standard 61967-2, *Measurement of Radiated Emissions—TEM Cell and Wideband TEM Cell Method*

## 6.2 Switching specifications

### 6.2.1 Control timing

**Table 7. Control timing**

Num	C	Rating		Symbol	Min	Typical <sup>1</sup>	Max	Unit
1	P	Bus frequency (t <sub>cyc</sub> = 1/f <sub>Bus</sub> )		f <sub>Bus</sub>	DC	—	20	MHz
2	P	Internal low power oscillator frequency		f <sub>LPO</sub>	0.67	1.0	1.25	KHz
3	D	External reset pulse width <sup>2</sup>		t <sub>extrst</sub>	1.5 × t <sub>cyc</sub>	—	—	ns
4	D	Reset low drive		t <sub>rstdrv</sub>	34 × t <sub>cyc</sub>	—	—	ns
5	D	BKGD/MS setup time after issuing background debug force reset to enter user or BDM modes		t <sub>MSSU</sub>	500	—	—	ns
6	D	BKGD/MS hold time after issuing background debug force reset to enter user or BDM modes <sup>3</sup>		t <sub>MSH</sub>	100	—	—	ns
7	D	IRQ pulse width	Asynchronous path <sup>2</sup>	t <sub>LIH</sub>	100	—	—	ns
	D		Synchronous path <sup>4</sup>	t <sub>IHIL</sub>	1.5 × t <sub>cyc</sub>	—	—	ns
8	D	Keyboard interrupt pulse width	Asynchronous path <sup>2</sup>	t <sub>LIH</sub>	100	—	—	ns
	D		Synchronous path	t <sub>IHIL</sub>	1.5 × t <sub>cyc</sub>	—	—	ns
9	C	Port rise and fall time - standard drive strength (load = 50 pF) <sup>5</sup>	—	t <sub>Rise</sub>	—	10.2	—	ns
	C		—	t <sub>Fall</sub>	—	9.5	—	ns

Table continues on the next page...

Table 7. Control timing (continued)

Num	C	Rating	Symbol	Min	Typical <sup>1</sup>	Max	Unit	
	C	Port rise and fall time - high drive strength (load = 50 pF) <sup>5</sup>	—	$t_{\text{Rise}}$	—	5.4	—	ns
	C			$t_{\text{Fall}}$	—	4.6	—	ns

1. Typical values are based on characterization data at  $V_{\text{DD}} = 5.0 \text{ V}$ ,  $25 \text{ }^\circ\text{C}$  unless otherwise stated.
2. This is the shortest pulse that is guaranteed to be recognized as a reset pin request.
3. To enter BDM mode following a POR, BKGD/MS must be held low during the powerup and for a hold time of  $t_{\text{MSH}}$  after  $V_{\text{DD}}$  rises above  $V_{\text{LVD}}$ .
4. This is the minimum pulse width that is guaranteed to pass through the pin synchronization circuitry. Shorter pulses may or may not be recognized. In stop mode, the synchronizer is bypassed so shorter pulses can be recognized.
5. Timing is shown with respect to 20%  $V_{\text{DD}}$  and 80%  $V_{\text{DD}}$  levels in operating temperature range.

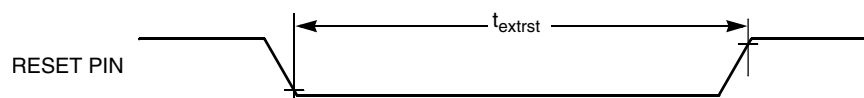

Figure 10. Reset timing

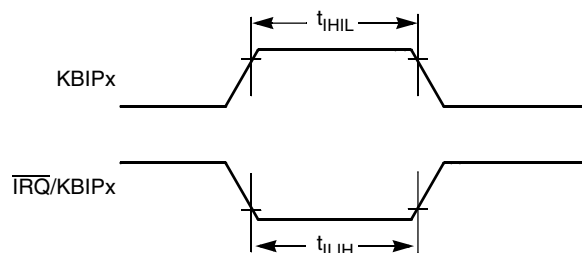

Figure 11. IRQ/KBIPx timing

## 6.2.2 Debug trace timing specifications

Table 8. Debug trace operating behaviors

Symbol	Description	Min.	Max.	Unit
$t_{\text{cyc}}$	Clock period	Frequency dependent		MHz
$t_{\text{wl}}$	Low pulse width	2	—	ns
$t_{\text{wh}}$	High pulse width	2	—	ns
$t_{\text{r}}$	Clock and data rise time	—	3	ns
$t_{\text{f}}$	Clock and data fall time	—	3	ns
$t_{\text{s}}$	Data setup	3	—	ns
$t_{\text{h}}$	Data hold	2	—	ns

## Switching specifications

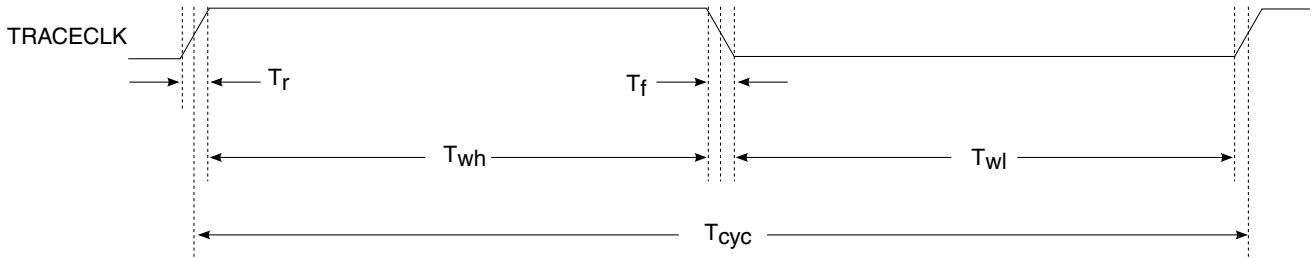

Figure 12. TRACE\_CLKOUT specifications

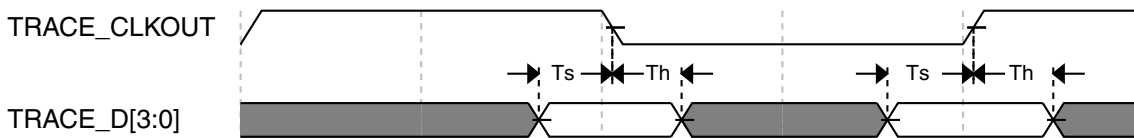

Figure 13. Trace data specifications

### 6.2.3 FTM module timing

Synchronizer circuits determine the shortest input pulses that can be recognized or the fastest clock that can be used as the optional external source to the timer counter. These synchronizers operate from the current bus rate clock.

Table 9. FTM input timing

No.	C	Function	Symbol	Min	Max	Unit
1	D	External clock frequency	$f_{TCLK}$	0	$f_{Bus}/4$	Hz
2	D	External clock period	$t_{TCLK}$	4	—	$t_{cyc}$
3	D	External clock high time	$t_{clkh}$	1.5	—	$t_{cyc}$
4	D	External clock low time	$t_{clkl}$	1.5	—	$t_{cyc}$
5	D	Input capture pulse width	$t_{ICPW}$	1.5	—	$t_{cyc}$

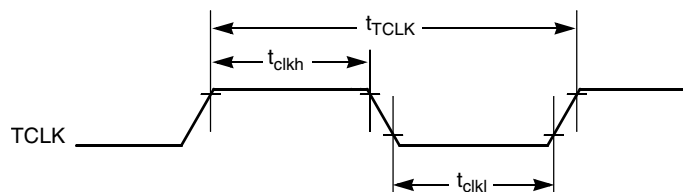

Figure 14. Timer external clock

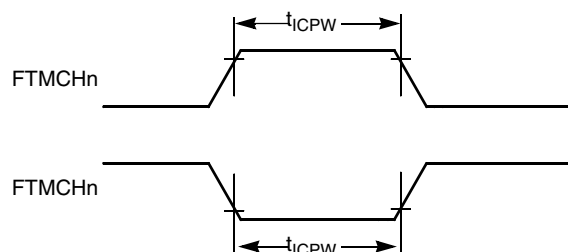

Figure 15. Timer input capture pulse

## 6.3 Thermal specifications

### 6.3.1 Thermal characteristics

This section provides information about operating temperature range, power dissipation, and package thermal resistance. Power dissipation on I/O pins is usually small compared to the power dissipation in on-chip logic and voltage regulator circuits, and it is user-determined rather than being controlled by the MCU design. To take  $P_{I/O}$  into account in power calculations, determine the difference between actual pin voltage and  $V_{SS}$  or  $V_{DD}$  and multiply by the pin current for each I/O pin. Except in cases of unusually high pin current (heavy loads), the difference between pin voltage and  $V_{SS}$  or  $V_{DD}$  will be very small.

Table 10. Thermal characteristics

Rating	Symbol	Value	Unit
Operating temperature range (packaged)	$T_A^1$	$T_L$ to $T_H$ <ul style="list-style-type: none"> <li>-40 to 125 for MC9S08PA4(A)Mxx parts</li> <li>-40 to 105 for MC9S08PA4(A)Vxx parts</li> </ul>	$^{\circ}\text{C}$
Junction temperature range	$T_J$	<ul style="list-style-type: none"> <li>-40 to 135 for MC9S08PA4(A)Mxx parts</li> <li>-40 to 125 for MC9S08PA4(A)Vxx parts</li> </ul>	$^{\circ}\text{C}$
Thermal resistance single-layer board			
20-pin SOIC	$R_{\theta JA}$	82	$^{\circ}\text{C}/\text{W}$
20-pin TSSOP	$R_{\theta JA}$	115	$^{\circ}\text{C}/\text{W}$
16-pin TSSOP	$R_{\theta JA}$	130	$^{\circ}\text{C}/\text{W}$
8-pin DFN	$R_{\theta JA}$	170	$^{\circ}\text{C}/\text{W}$
8-pin SOIC	$R_{\theta JA}$	150	$^{\circ}\text{C}/\text{W}$
Thermal resistance four-layer board			
20-pin SOIC	$R_{\theta JA}$	54	$^{\circ}\text{C}/\text{W}$
20-pin TSSOP	$R_{\theta JA}$	76	$^{\circ}\text{C}/\text{W}$
16-pin TSSOP	$R_{\theta JA}$	87	$^{\circ}\text{C}/\text{W}$
8-pin DFN	$R_{\theta JA}$	43	$^{\circ}\text{C}/\text{W}$
8-pin SOIC	$R_{\theta JA}$	87	$^{\circ}\text{C}/\text{W}$

## Peripheral operating requirements and behaviors

- Maximum  $T_A$  can be exceeded only if the user ensures that  $T_J$  does not exceed the maximum. The simplest method to determine  $T_J$  is:  $T_J = T_A + R_{\theta JA} \times \text{chip power dissipation}$ .

# 7 Peripheral operating requirements and behaviors

## 7.1 External oscillator (XOSC) and ICS characteristics

Table 11. XOSC and ICS specifications in operating temperature range

Num	C	Characteristic		Symbol	Min	Typical <sup>1</sup>	Max	Unit
1	C	Oscillator crystal or resonator	Low range (RANGE = 0)	$f_{lo}$	31.25	32.768	39.0625	kHz
	C		High range (RANGE = 1) FEE or FBE mode <sup>2</sup>	$f_{hi}$	4	—	20	MHz
	C		High range (RANGE = 1), high gain (HGO = 1), FBELP mode	$f_{hi}$	4	—	20	MHz
	C		High range (RANGE = 1), low power (HGO = 0), FBELP mode	$f_{hi}$	4	—	20	MHz
2	D	Load capacitors		C1, C2	See Note <sup>3</sup>			
3	D	Feedback resistor	Low Frequency, Low-Power Mode <sup>4</sup>	$R_F$	—	—	—	M $\Omega$
			Low Frequency, High-Gain Mode		—	10	—	M $\Omega$
			High Frequency, Low-Power Mode		—	1	—	M $\Omega$
			High Frequency, High-Gain Mode		—	1	—	M $\Omega$
4	D	Series resistor - Low Frequency	Low-Power Mode <sup>4</sup>	$R_S$	—	—	—	k $\Omega$
			High-Gain Mode		—	200	—	k $\Omega$
5	D	Series resistor - High Frequency	Low-Power Mode <sup>4</sup>	$R_S$	—	—	—	k $\Omega$
	D	Series resistor - High Frequency, High-Gain Mode	4 MHz		—	0	—	k $\Omega$
	D		8 MHz		—	0	—	k $\Omega$
	D		16 MHz		—	0	—	k $\Omega$
6	C	Crystal start-up time Low range = 32.768 kHz crystal; High range = 20 MHz crystal <sup>5, 6</sup>	Low range, low power	$t_{CSTL}$	—	1000	—	ms
	C		Low range, high power		—	800	—	ms
	C		High range, low power	$t_{CSTH}$	—	3	—	ms
	C		High range, high power		—	1.5	—	ms
7	T	Internal reference start-up time		$t_{IRST}$	—	20	50	$\mu$ s
8	D	Square wave input clock frequency	FEE or FBE mode <sup>2</sup>	$f_{extal}$	0.03125	—	5	MHz
	D		FBELP mode		0	—	20	MHz

Table continues on the next page...

**Table 11. XOSC and ICS specifications in operating temperature range (continued)**

Num	C	Characteristic	Symbol	Min	Typical <sup>1</sup>	Max	Unit
9	P	Average internal reference frequency - trimmed	$f_{int\_t}$	—	31.25	—	kHz
10	P	DCO output frequency range - trimmed	$f_{dco\_t}$	16	—	20	MHz
11	P	Total deviation of DCO output from trimmed frequency <sup>5</sup>	$\Delta f_{dco\_t}$	—	—	±2.0	% $f_{dco}$
	C					Over fixed voltage and temperature range of 0 to 70 °C	
12	C	FLL acquisition time <sup>5, 7</sup>	$t_{Acquire}$	—	—	2	ms
13	C	Long term jitter of DCO output clock (averaged over 2 ms interval) <sup>8</sup>	$C_{Jitter}$	—	0.02	0.2	% $f_{dco}$

1. Data in Typical column was characterized at 5.0 V, 25 °C or is typical recommended value.
2. When ICS is configured for FEE or FBE mode, input clock source must be divisible using RDIV to within the range of 31.25 kHz to 39.0625 kHz.
3. See crystal or resonator manufacturer's recommendation.
4. Load capacitors ( $C_1, C_2$ ), feedback resistor ( $R_F$ ) and series resistor ( $R_S$ ) are incorporated internally when RANGE = HGO = 0.
5. This parameter is characterized and not tested on each device.
6. Proper PC board layout procedures must be followed to achieve specifications.
7. This specification applies to any time the FLL reference source or reference divider is changed, trim value changed, or changing from FLL disabled (FBELP, FBILP) to FLL enabled (FEI, FEE, FBE, FBI). If a crystal/resonator is being used as the reference, this specification assumes it is already running.
8. Jitter is the average deviation from the programmed frequency measured over the specified interval at maximum  $f_{BUS}$ . Measurements are made with the device powered by filtered supplies and clocked by a stable external clock signal. Noise injected into the FLL circuitry via  $V_{DD}$  and  $V_{SS}$  and variation in crystal oscillator frequency increase the  $C_{Jitter}$  percentage for a given interval.

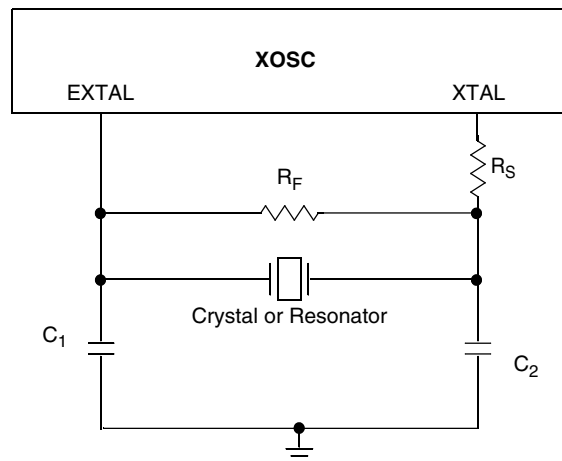
**Figure 16. Typical crystal or resonator circuit**

## 7.2 NVM specifications

This section provides details about program/erase times and program/erase endurance for the flash and EEPROM memories.

**Table 12. Flash clock characteristics**

C	Characteristic	Symbol	Min	Typical	Max	Unit
D	Supply voltage for program/erase across the operating temperature range	$V_{\text{prog/erase}}$	2.7	—	5.5	V
D	Supply voltage for read operation	$V_{\text{Read}}$	2.7	—	5.5	V
D	NVM Bus frequency	$f_{\text{NVMBUS}}$	1	—	20	MHz
D	NVM operating frequency	$f_{\text{NVMOP}}$	0.8	1.0	1.05	MHz
C	FLASH Program/erase endurance $T_L$ to $T_H$ in the operating temperature range	$n_{\text{FLPE}}$	10 k	100 k	—	Cycles
C	EEPROM Program/erase endurance $T_L$ to $T_H$ in the operating temperature range	$n_{\text{FLPE}}$	50 k	500 k	—	Cycles
C	Data retention at an average junction temperature of $T_{\text{Javg}} = 85^\circ\text{C}$ after up to 10,000 program/erase cycles	$t_{\text{D\_ret}}$	15	100	—	years

All timing parameters are a function of the bus clock frequency,  $f_{\text{NVMBUS}}$ . All program and erase times are also a function of the NVM operating frequency,  $f_{\text{NVMOP}}$ .

Each command timing is given by:

$$t_{\text{command}} = f_{\text{NVMOP}} \text{ cycle} \times 1/f_{\text{NVMOP}} + f_{\text{NVMBUS}} \text{ cycle} \times 1/f_{\text{NVMBUS}}$$

**Table 13. Flash timing characteristics**

C	Characteristic	Symbol	$f_{\text{NVMOP}}$ cycle	$f_{\text{NVMBUS}}$ cycle
D	Erase Verify All Blocks	$t_{\text{VFYALL}}$	—	1850
D	Erase Verify Flash Block	$t_{\text{RD1BLK}}$	—	1559
D	Erase Verify EEPROM Block	$t_{\text{RD1BLK}}$	—	682
D	Erase Verify Flash Section	$t_{\text{RD1SEC}}$	—	494
D	Erase Verify EEPROM Section	$t_{\text{DRD1SEC}}$	—	555
D	Read Once	$t_{\text{RDONCE}}$	—	450
D	Program Flash (2 word)	$t_{\text{PGM2}}$	68	1407
D	Program Flash (4 word)	$t_{\text{PGM4}}$	122	2138
D	Program Once	$t_{\text{PGMONCE}}$	122	2090
D	Program EEPROM (1 Byte)	$t_{\text{DPGM1}}$	47	1371
D	Program EEPROM (2 Byte)	$t_{\text{DPGM2}}$	94	2120
D	Program EEPROM (3 Byte)	$t_{\text{DPGM3}}$	141	2869
D	Program EEPROM (4 Byte)	$t_{\text{DPGM4}}$	188	3618
D	Erase All Blocks	$t_{\text{ERSALL}}$	100066	2255
D	Erase Flash Block	$t_{\text{ERSBLK}}$	100060	1882
D	Erase Flash Sector	$t_{\text{ERSPG}}$	20015	878
D	Erase EEPROM Sector	$t_{\text{DERSPG}}$	5015	756
D	Unsecure Flash	$t_{\text{UNSECU}}$	100066	2242

Table continues on the next page...

**Table 13. Flash timing characteristics (continued)**

C	Characteristic	Symbol	f <sub>NVMOP</sub> cycle	f <sub>NVMBUS</sub> cycle
D	Verify Backdoor Access Key	t <sub>VFYKEY</sub>	—	464
D	Set User Margin Level	t <sub>MLOADU</sub>	—	413

Program and erase operations do not require any special power sources other than the normal V<sub>DD</sub> supply. For more detailed information about program/erase operations, see the Memory section.

## 7.3 Analog

### 7.3.1 ADC characteristics

**Table 14. 5 V 12-bit ADC operating conditions**

Characteristic	Conditions	Symb	Min	Typ <sup>1</sup>	Max	Unit	Comment
Supply voltage	Absolute	V <sub>DDA</sub>	2.7	—	5.5	V	—
	Delta to V <sub>DD</sub> (V <sub>DD</sub> -V <sub>DDAD</sub> )	ΔV <sub>DDA</sub>	-100	0	+100	mV	
Ground voltage	Delta to V <sub>SS</sub> (V <sub>SS</sub> -V <sub>SSA</sub> ) <sup>2</sup>	ΔV <sub>SSA</sub>	-100	0	+100	mV	
Input voltage		V <sub>ADIN</sub>	V <sub>REFL</sub>	—	V <sub>REFH</sub>	V	
Input capacitance		C <sub>ADIN</sub>	—	4.5	5.5	pF	
Input resistance		R <sub>ADIN</sub>	—	3	5	kΩ	—
Analog source resistance	12-bit mode	R <sub>AS</sub>	—	—	2	kΩ	External to MCU
	• f <sub>ADCK</sub> > 4 MHz		—	—	5		
	• f <sub>ADCK</sub> < 4 MHz		—	—	5		
10-bit mode	—	—	5	kΩ	External to MCU		
• f <sub>ADCK</sub> > 4 MHz	—	—	10				
• f <sub>ADCK</sub> < 4 MHz	—	—	10				
8-bit mode (all valid f <sub>ADCK</sub> )							
ADC conversion clock frequency	High speed (ADLPC=0)	f <sub>ADCK</sub>	0.4	—	8.0	MHz	—
	Low power (ADLPC=1)		0.4	—	4.0		

1. Typical values assume V<sub>DDA</sub> = 5.0 V, Temp = 25°C, f<sub>ADCK</sub>=1.0 MHz unless otherwise stated. Typical values are for reference only and are not tested in production.
2. DC potential difference.

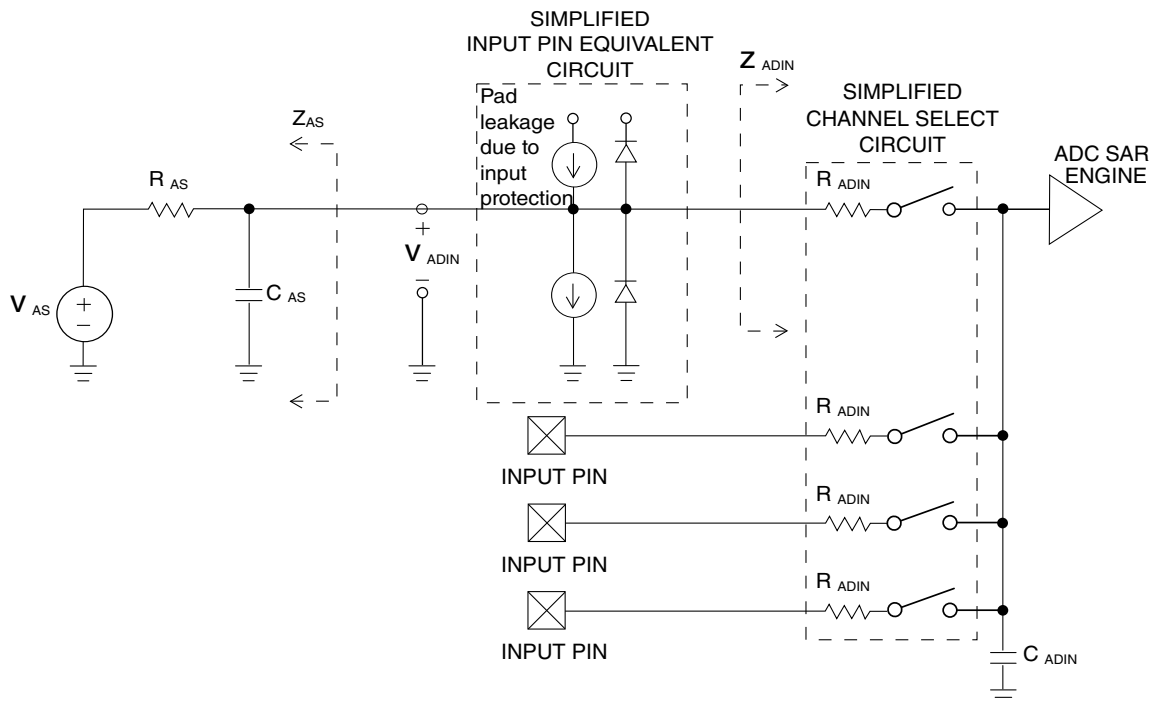

Figure 17. ADC input impedance equivalency diagram

Table 15. 12-bit ADC Characteristics ( $V_{REFH} = V_{DDA}$ ,  $V_{REFL} = V_{SSA}$ )

Characteristic	Conditions	C	Symb	Min	Typ <sup>1</sup>	Max	Unit
Supply current ADLPC = 1 ADLSMP = 1 ADCO = 1		T	$I_{DDA}$	—	133	—	$\mu\text{A}$
Supply current ADLPC = 1 ADLSMP = 0 ADCO = 1		T	$I_{DDA}$	—	218	—	$\mu\text{A}$
Supply current ADLPC = 0 ADLSMP = 1 ADCO = 1		T	$I_{DDA}$	—	327	—	$\mu\text{A}$
Supply current ADLPC = 0 ADLSMP = 0 ADCO = 1		T	$I_{DDAD}$	—	582	990	$\mu\text{A}$
Supply current	Stop, reset, module off	T	$I_{DDA}$	—	0.011	1	$\mu\text{A}$
ADC asynchronous clock source	High speed (ADLPC = 0)	P	$f_{ADACK}$	2	3.3	5	MHz

Table continues on the next page...

**Table 15. 12-bit ADC Characteristics ( $V_{REFH} = V_{DDA}$ ,  $V_{REFL} = V_{SSA}$ ) (continued)**

Characteristic	Conditions	C	Symb	Min	Typ <sup>1</sup>	Max	Unit
	Low power (ADLPC = 1)			1.25	2	3.3	
Conversion time (including sample time)	Short sample (ADLSMP = 0)	T	$t_{ADC}$	—	20	—	ADCK cycles
	Long sample (ADLSMP = 1)			—	40	—	
Sample time	Short sample (ADLSMP = 0)	T	$t_{ADS}$	—	3.5	—	ADCK cycles
	Long sample (ADLSMP = 1)			—	23.5	—	
Total unadjusted Error <sup>2</sup>	12-bit mode	T	$E_{TUE}$	—	$\pm 5.0$	—	LSB <sup>3</sup>
	10-bit mode	P		—	$\pm 1.5$	$\pm 2.0$	
	8-bit mode	P		—	$\pm 0.7$	$\pm 1.0$	
Differential Non-Linearity	12-bit mode	T	DNL	—	$\pm 1.0$	—	LSB <sup>3</sup>
	10-bit mode <sup>4</sup>	P		—	$\pm 0.25$	$\pm 0.5$	
	8-bit mode <sup>4</sup>	P		—	$\pm 0.15$	$\pm 0.25$	
Integral Non-Linearity	12-bit mode	T	INL	—	$\pm 1.0$	—	LSB <sup>3</sup>
	10-bit mode	T		—	$\pm 0.3$	$\pm 0.5$	
	8-bit mode	T		—	$\pm 0.15$	$\pm 0.25$	
Zero-scale error <sup>5</sup>	12-bit mode	C	$E_{ZS}$	—	$\pm 2.0$	—	LSB <sup>3</sup>
	10-bit mode	P		—	$\pm 0.25$	$\pm 1.0$	
	8-bit mode	P		—	$\pm 0.65$	$\pm 1.0$	
Full-scale error <sup>6</sup>	12-bit mode	T	$E_{FS}$	—	$\pm 2.5$	—	LSB <sup>3</sup>
	10-bit mode	T		—	$\pm 0.5$	$\pm 1.0$	
	8-bit mode	T		—	$\pm 0.5$	$\pm 1.0$	
Quantization error	$\leq 12$ bit modes	D	$E_Q$	—	—	$\pm 0.5$	LSB <sup>3</sup>
Input leakage error <sup>7</sup>	all modes	D	$E_{IL}$	$I_{in} * R_{AS}$			mV
Temp sensor slope	-40°C– 25°C	D	m	—	3.266	—	mV/°C
	25°C– 125°C			—	3.638	—	
Temp sensor voltage	25°C	D	$V_{TEMP25}$	—	1.396	—	V

1. Typical values assume  $V_{DDA} = 5.0$  V, Temp = 25°C,  $f_{ADCK} = 1.0$  MHz unless otherwise stated. Typical values are for reference only and are not tested in production.
2. Includes quantization.
3.  $1 \text{ LSB} = (V_{REFH} - V_{REFL})/2^N$
4. Monotonicity and no-missing-codes guaranteed in 10-bit and 8-bit modes
5.  $V_{ADIN} = V_{SSA}$
6.  $V_{ADIN} = V_{DDA}$
7.  $I_{in}$  = leakage current (refer to DC characteristics)

## 7.3.2 Analog comparator (ACMP) electricals

Table 16. Comparator electrical specifications

C	Characteristic	Symbol	Min	Typical	Max	Unit
D	Supply voltage	$V_{DDA}$	2.7	—	5.5	V
T	Supply current (Operation mode)	$I_{DDA}$	—	10	20	$\mu$ A
D	Analog input voltage	$V_{AIN}$	$V_{SS} - 0.3$	—	$V_{DDA}$	V
P	Analog input offset voltage	$V_{AIO}$	—	—	40	mV
C	Analog comparator hysteresis (HYST=0)	$V_H$	—	15	20	mV
C	Analog comparator hysteresis (HYST=1)	$V_H$	—	20	30	mV
T	Supply current (Off mode)	$I_{DDAOFF}$	—	60	—	nA
C	Propagation Delay	$t_D$	—	0.4	1	$\mu$ s

## 8 Dimensions

### 8.1 Obtaining package dimensions

Package dimensions are provided in package drawings.

To find a package drawing, go to [nxp.com](http://nxp.com) and perform a keyword search for the drawing's document number:

If you want the drawing for this package	Then use this document number
8-pin DFN	98ASA00448D
8-pin SOIC	98ASB42564B
16-pin TSSOP	98ASH70247A
20-pin SOIC	98ASB42343B
20-pin TSSOP	98ASH70169A

## 9 Pinout

### 9.1 Signal multiplexing and pin assignments

The following table shows the signals available on each pin and the locations of these pins on the devices supported by this document. The Port Control Module is responsible for selecting which ALT functionality is available on each pin.

Table 17. Pin availability by package pin-count

Pin Number			Lowest Priority <-- --> Highest				
20-SOIC/ TSSOP	16-TSSOP	8-DFN/SOIC	Port Pin	Alt 1	Alt 2	Alt 3	Alt 4
1	1	1	PTA5	IRQ	FTM1CH0	—	RESET
2	2	2	PTA4	—	ACMPO	BKGD	MS
3	3	3	—	—	—	—	V <sub>DD</sub>
4	4	4	—	—	—	—	V <sub>SS</sub>
5	5	—	PTB7	—	—	—	EXTAL
6	6	—	PTB6	—	—	—	XTAL
7	7	—	PTB5 <sup>1</sup>	—	FTM1CH1	—	—
8	8	—	PTB4 <sup>1</sup>	—	FTM1CH0	—	—
9	—	—	PTC3	—	—	—	—
10	—	—	PTC2	—	—	—	—
11	—	—	PTC1	—	—	—	—
12	—	—	PTC0	—	—	—	—
13	9	—	PTB3	KBIOP7	—	TCLK1	ADP7
14	10	—	PTB2	KBIOP6	—	—	ADP6
15	11	—	PTB1	KBIOP5	TxD0	—	ADP5
16	12	—	PTB0 <sup>2</sup>	KBIOP4	RxD0	TCLK0	ADP4
17	13	5	PTA3	KBIOP3	FTM0CH1	TxD0	ADP3
18	14	6	PTA2	KBIOP2	FTM0CH0	RxD0	ADP2
19	15	7	PTA1	KBIOP1	FTM0CH1	ACMP1	ADP1
20	16	8	PTA0	KBIOP0	FTM0CH0	ACMP0	ADP0

1. This is a high current drive pin when operated as output.
2. This is a true open-drain pin when operated as output.

### Note

When an alternative function is first enabled, it is possible to get a spurious edge to the module. User software must clear any associated flags before interrupts are enabled. The table above illustrates the priority if multiple modules are enabled. The highest priority module will have control over the pin. Selecting a higher priority pin function with a lower priority function already enabled can cause spurious edges to the lower priority module. Disable all modules that share a pin before enabling another module.

## 9.2 Device pin assignment

## Revision history

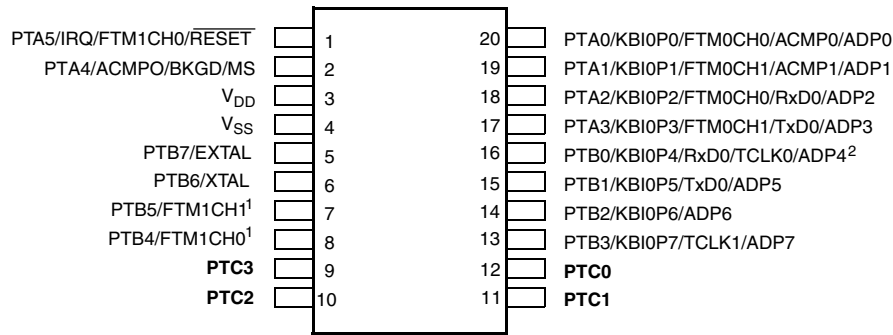

Pins in **bold** are not available on less pin-count packages.

1. High source/sink current pins
2. True open drain pins

**Figure 18. MC9S08PA4 20-pin SOIC/TSSOP packages**

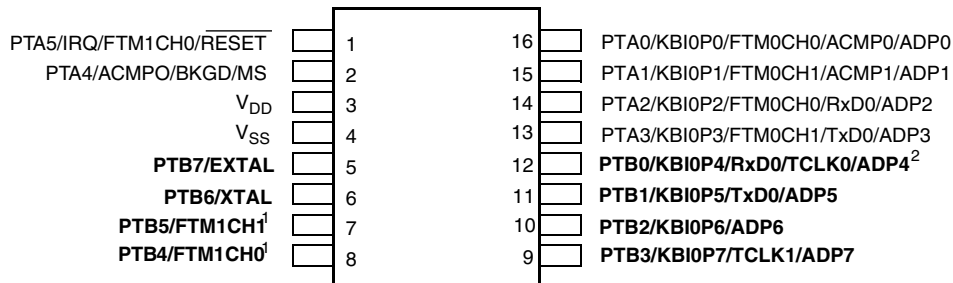

Pins in **bold** are not available on less pin-count packages.

1. High source/sink current pins
2. True open drain pins

**Figure 19. 16-pin TSSOP package**

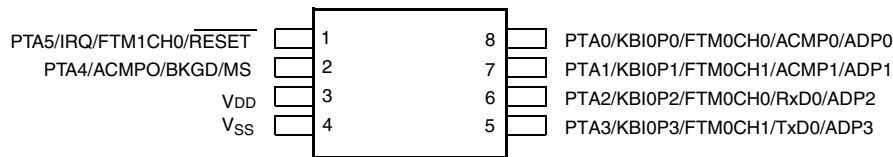

**Figure 20. 8-pin DFN/SOIC packages**

## 10 Revision history

The following table provides a revision history for this document.

**Table 18. Revision history**

Rev. No.	Date	Substantial Changes
2	12/2012	Initial public release
3	5/2014	<ul style="list-style-type: none"> <li>• Renamed the low drive strength to standard drive strength.</li> <li>• Updated <math>V_{DIO}</math>.</li> <li>• Added footnote on the <math>S3I_{DD}</math></li> </ul>

Table continues on the next page...

Table 18. Revision history (continued)

Rev. No.	Date	Substantial Changes
		<ul style="list-style-type: none"> <li>Updated EMC test conditions to be <math>f_{OSC} = 10</math> MHz and <math>f_{SYS} = 20</math> MHz</li> <li>Updated <math>f_{int\_t}</math></li> <li>Updated Flash characteristics</li> <li>Updated the rating descriptions for <math>t_{Rise}</math> and <math>t_{Fall}</math></li> <li>Updated footnote on <math>t_{Acquire}</math></li> <li>Added new part of MC9S08PA4MTG with operating temperature range from -40 to 125 °C</li> <li>Updated <math>I_{LAT}</math></li> </ul>
3.1	09/2014	<ul style="list-style-type: none"> <li>Updated the part number format to add new field for new part numbers in <a href="#">Fields</a>.</li> </ul>
4	06/2015	<ul style="list-style-type: none"> <li>Corrected the Min. of the <math>t_{extrst}</math> in <a href="#">Control timing</a></li> <li>Updated <a href="#">Thermal characteristics</a> to add footnote to the <math>T_A</math> and removed redundant information..</li> </ul>
5	01/2017	<ul style="list-style-type: none"> <li>Updated to add FTM2 module.</li> </ul>
6	08/2017	<ul style="list-style-type: none"> <li>Updated to add new package of 8-pin DFN.</li> </ul>
7	12/2017	<ul style="list-style-type: none"> <li>Updated to add new packages of 20-pin TSSOP and 8-pin SOIC.</li> </ul>
8	08/2018	<ul style="list-style-type: none"> <li>Added a note in <a href="#">Fields</a>.</li> </ul>
9	01/2019	<ul style="list-style-type: none"> <li>Updated the <math>S3I_{DD}</math> Typical values in <a href="#">Supply current characteristics</a>.</li> <li>Added the package drawing information of 20-pin TSSOP.</li> </ul>
10	03/2020	<ul style="list-style-type: none"> <li>Added new part of MC9S08PA4AMSC and updated the related information in the whole book.</li> <li>Added <a href="#">MCU block diagram</a>.</li> <li>Updated <math>T_j</math> in the <a href="#">Thermal characteristics</a>.</li> <li>Updated flash characteristics in the <a href="#">NVM specifications</a></li> </ul>

**How to Reach Us:****Home Page:**[nxp.com](http://nxp.com)**Web Support:**[nxp.com/support](http://nxp.com/support)

Information in this document is provided solely to enable system and software implementers to use NXP products. There are no express or implied copyright licenses granted hereunder to design or fabricate any integrated circuits based on the information in this document. NXP reserves the right to make changes without further notice to any products herein.

NXP makes no warranty, representation, or guarantee regarding the suitability of its products for any particular purpose, nor does NXP assume any liability arising out of the application or use of any product or circuit, and specifically disclaims any and all liability, including without limitation consequential or incidental damages. "Typical" parameters that may be provided in NXP data sheets and/or specifications can and do vary in different applications, and actual performance may vary over time. All operating parameters, including "typicals," must be validated for each customer application by customer's technical experts. NXP does not convey any license under its patent rights nor the rights of others. NXP sells products pursuant to standard terms and conditions of sale, which can be found at the following address: [nxp.com/SalesTermsandConditions](http://nxp.com/SalesTermsandConditions).

While NXP has implemented advanced security features, all products may be subject to unidentified vulnerabilities. Customers are responsible for the design and operation of their applications and products to reduce the effect of these vulnerabilities on customer's applications and products, and NXP accepts no liability for any vulnerability that is discovered. Customers should implement appropriate design and operating safeguards to minimize the risks associated with their applications and products.



NXP, the NXP logo, NXP SECURE CONNECTIONS FOR A SMARTER WORLD, COOLFLUX, EMBRACE, GREENCHIP, HITAG, ICODE, JCOP, LIFE VIBES, MIFARE, MIFARE CLASSIC, MIFARE DESFire, MIFARE PLUS, MIFARE FLEX, MANTIS, MIFARE ULTRALIGHT, MIFARE4MOBILE, MIGLO, NTAG, ROADLINK, SMARTLX, SMARTMX, STARPLUG, TOPFET, TRENCHMOS, UCODE, Freescale, the Freescale logo, AltiVec, CodeWarrior, ColdFire, ColdFire+, the Energy Efficient Solutions logo, Kinetis, Layerscape, MagniV, mobileGT, PEG, PowerQUICC, Processor Expert, QorIQ, QorIQ Qonverge, SafeAssure, the SafeAssure logo, StarCore, Symphony, VortiQa, Vybrid, Airfast, BeeKit, BeeStack, CoreNet, Flexis, MXC, Platform in a Package, QUICC Engine, Tower, TurboLink, EdgeScale, EdgeLock, eIQ, and Immersive3D are trademarks of NXP B.V. All other product or service names are the property of their respective owners. AMBA, Arm, Arm7, Arm7TDMI, Arm9, Arm11, Artisan, big.LITTLE, Cordio, CoreLink, CoreSight, Cortex, DesignStart, DynamiQ, Jazelle, Keil, Mali, Mbed, Mbed Enabled, NEON, POP, RealView, SecurCore, Socrates, Thumb, TrustZone, ULINK, ULINK2, ULINK-ME, ULINK-PLUS, ULINKpro,  $\mu$ Vision, Versatile are trademarks or registered trademarks of Arm Limited (or its subsidiaries) in the US and/or elsewhere. The related technology may be protected by any or all of patents, copyrights, designs and trade secrets. All rights reserved. Oracle and Java are registered trademarks of Oracle and/or its affiliates. The Power Architecture and Power.org word marks and the Power and Power.org logos and related marks are trademarks and service marks licensed by Power.org.

© 2011-2020 NXP B.V.



## Looking for pricing, stock, or lifecycle information?

Click below to explore more details on WIN SOURCE:

-  [View MC9S08PA4AVWJ on WIN SOURCE](#)
-  [NXP / Nexperia Information](#)

## Optimize Your Supply Chain with WIN SOURCE Solutions

-  Global Sourcing Solution
-  Obsolete Management
-  Cost Control Management
-  Shortage Management
-  Alternative Solution
-  Excess Inventory Management