



# THE DATASHEET OF MAX5970ETX+



# 0V to 16V, Dual Hot-Swap Controller with 10-Bit Current and Voltage Monitor and 4 LED Drivers

## General Description

The MAX5970 dual hot-swap controller provides complete protection for systems with two supply voltages from 0V to +16V. The MAX5970 includes four programmable LED outputs. The two hot-swap channels can be configured to operate as independent hot-swap controllers, or as a pair operating together so that both channels shut down if either channel experiences a fault.

The MAX5970 provides two programmable levels of overcurrent circuit-breaker protection: a fast-trip threshold for a fast turn-off, and a lower slow-trip threshold for a delayed turn-off. The maximum overcurrent circuit-breaker threshold range is set independently for each channel with a trilevel logic input IRNG<sub>+</sub>, or by programming through the I<sup>2</sup>C interface.

The MAX5970 is an advanced hot-swap controller that monitors voltage and current with an internal 10-bit ADC which is continuously multiplexed to convert the output voltage and current of both hot-swap channels at 10ksps. Each 10-bit sample is stored in an internal circular buffer so that 50 past samples of each signal can be read back through the I<sup>2</sup>C interface at any time or after a fault condition.

The device includes five user-programmable digital comparators per hot-swap channel to implement overcurrent warning and two levels of overvoltage/undervoltage detection. When any of the measured values violates the programmable limits, an external  $\overline{\text{ALERT}}$  output is asserted. In addition to the  $\overline{\text{ALERT}}$  signal, the MAX5970 can be programmed to deassert the power-good signal and/or turn off the external MOSFET.

The MAX5970 features four I/Os that can be independently configured as general-purpose inputs/outputs (GPIOs) or as open-drain LED drivers with programmable blinking. These four I/Os can be configured for any mix of LED driver or GPIO function.

The MAX5970 is available in a 36-pin thin QFN-EP package and operates over the -40°C to +85°C extended temperature range.

## Features

- ◆ Two Independent Hot-Swap Controllers Operate from 0V to +16V
- ◆ 10-Bit ADC Monitors Voltage and Current of Each Channel
- ◆ Circular Buffers Store 5ms of Current and Voltage Measurements
- ◆ Two Independent Internal Charge Pumps Generate n-Channel MOSFET Gate Drives
- ◆ Internal 500mA Gate Pulldown Current for Fast Shutdown
- ◆ VariableSpeed/BiLevel™ Circuit-Breaker Protection
- ◆ Independent Precision-Voltage Enable Inputs
- ◆ Alert Output Indicates Fault and Warning Conditions
- ◆ Independent Power-Good Outputs
- ◆ Independent Fault Outputs
- ◆ Four Open-Drain Outputs Sink 25mA to Directly Drive LEDs
- ◆ Programmable LED Flashing Function
- ◆ Autoretry or Latched Fault Management
- ◆ 400kHz I<sup>2</sup>C Interface
- ◆ Small 6mm x 6mm, 36-Pin TQFN-EP Package

## Applications

Single PCI Express® Hot-Plug Slot

Blade Servers

Disk Drives/DASD/Storage Systems

Soft-Switch for ASICs, FPGAs, and Microcontrollers with Independent Core and I/O Voltages

## Ordering Information

PART	TEMP RANGE	PIN-PACKAGE
MAX5970ETX+	-40°C to +85°C	36 TQFN-EP*

+Denotes a lead(Pb)-free/RoHS-compliant package.

\*EP = Exposed pad.

VariableSpeed/BiLevel is a trademark of Maxim Integrated Products, Inc.

PCI Express is a registered trademark of PCI-SIG Corp.

# 0V to 16V, Dual Hot-Swap Controller with 10-Bit Current and Voltage Monitor and 4 LED Drivers

## ABSOLUTE MAXIMUM RATINGS

IN, SENSE\_, MON\_, GATE\_ to AGND ..... -0.3V to +30V  
 LED\_ to AGND ..... -0.3V to +16V  
 ON\_, SDA, SCL to AGND..... -0.3V to +6V  
 REG, DREG, IRNG\_, MODE, PROT, A\_,  
 PG\_, ALERT\_, FAULT\_ to AGND..... -0.3V to +4V  
 REG to DREG ..... -0.3V to +0.3V  
 RETRY, HWEN, POL to AGND ..... -0.3V to (VREG + 0.3V)  
 GATE1 to MON1, GATE2 to MON2 ..... -0.3V to +6V  
 GND\_, DGND to AGND ..... -0.3V to +0.3V  
 SDA, ALERT Current ..... -20mA to +50mA  
 LED\_ Current ..... -20mA to +100mA

GATE\_, MON\_, GND\_ Current .....750mA  
 All Other Pins Input/Output Current .....20mA  
 Continuous Power Dissipation (T<sub>A</sub> = +70°C)  
 36-Pin, 6mm x 6mm TQFN  
 (derate 35.7mW/°C above +70°C)..... 2857mW\*\*  
 Junction-to-Ambient Thermal Resistance (θ<sub>JA</sub>) (Note 1).. 28°C/W  
 Operating Temperature Range ..... -40°C to +85°C  
 Junction Temperature ..... +150°C  
 Storage Temperature Range..... -65°C to +150°C  
 Lead Temperature (soldering, 10s) ..... +300°C

**Note 1:** Package thermal resistances were obtained using the method described in JEDEC specification JESD51-7, using a four-layer board. For detailed information on package thermal consideration, refer to [www.maxim-ic.com/thermal-tutorial](http://www.maxim-ic.com/thermal-tutorial).

\*\*As per JEDEC51 Standard (Multilayer Board)

Stresses beyond those listed under "Absolute Maximum Ratings" may cause permanent damage to the device. These are stress ratings only, and functional operation of the device at these or any other conditions beyond those indicated in the operational sections of the specifications is not implied. Exposure to absolute maximum rating conditions for extended periods may affect device reliability.

## ELECTRICAL CHARACTERISTICS

(V<sub>IN</sub> = 2.7V to 16V, T<sub>A</sub> = -40°C to +85°C, unless otherwise noted. Typical values are at V<sub>IN</sub> = 3.3V and T<sub>A</sub> = +25°C.) (Note 2)

PARAMETER	SYMBOL	CONDITIONS	MIN	TYP	MAX	UNITS
Supply Input-Voltage Range	V <sub>IN</sub>		2.7		16	V
Hot-Swap Voltage Range			0		16	V
Supply Current	I <sub>IN</sub>			2.5	4	mA
Internal LDO Output Voltage	REG	I <sub>REG</sub> = 0 to 5mA, V <sub>IN</sub> = 2.7V to 16V	2.49	2.53	2.6	V
Undervoltage Lockout	UVLO	V <sub>IN</sub> rising			2.7	V
Undervoltage Lockout Hysteresis	UVLO <sub>HYS</sub>			100		mV
<b>CURRENT-MONITORING FUNCTION</b>						
MON_, SENSE_ Input-Voltage Range			0		16	V
SENSE_ Input Current		V <sub>SENSE_</sub> , V <sub>MON_</sub> = 16V		32	75	μA
MON_ Input Current		V <sub>SENSE_</sub> , V <sub>MON_</sub> = 16V		180	280	μA
Current Measurement LSB Voltage		25mV range		24.34		μV
		50mV range		48.39		
		100mV range		96.77		
Current Measurement Error (25mV Range)	V <sub>MON_</sub> = 0V	V <sub>SENSE_</sub> - V <sub>MON_</sub> = 5mV	-6.57		+6.22	% FS
		V <sub>SENSE_</sub> - V <sub>MON_</sub> = 20mV	-6.71		+6.82	
	V <sub>MON_</sub> = 2.5V to 16V	V <sub>SENSE_</sub> - V <sub>MON_</sub> = 5mV	-9.71		+8.92	
		V <sub>SENSE_</sub> - V <sub>MON_</sub> = 20mV	-10.24		+9.36	
Current Measurement Error (50mV Range)	V <sub>MON_</sub> = 0V	V <sub>SENSE_</sub> - V <sub>MON_</sub> = 10mV	-4.24		+3.78	% FS
		V <sub>SENSE_</sub> - V <sub>MON_</sub> = 40mV	-4.53		+5.36	
	V <sub>MON_</sub> = 2.5V to 16V	V <sub>SENSE_</sub> - V <sub>MON_</sub> = 10mV	-4.50		+4.00	
		V <sub>SENSE_</sub> - V <sub>MON_</sub> = 40mV	-4.20		+4.50	

# 0V to 16V, Dual Hot-Swap Controller with 10-Bit Current and Voltage Monitor and 4 LED Drivers

## ELECTRICAL CHARACTERISTICS (continued)

( $V_{IN} = 2.7V$  to  $16V$ ,  $T_A = -40^{\circ}C$  to  $+85^{\circ}C$ , unless otherwise noted. Typical values are at  $V_{IN} = 3.3V$  and  $T_A = +25^{\circ}C$ .) (Note 2)

PARAMETER	SYMBOL	CONDITIONS	MIN	TYP	MAX	UNITS
Current Measurement Error (100mV Range)	$V_{MON\_} = 0V$	$V_{SENSE\_} - V_{MON\_} = 20mV$	-2.70		+2.43	% FS
		$V_{SENSE\_} - V_{MON\_} = 80mV$	-3.63		+4.56	
	$V_{MON\_} = 2.5V$ to $16V$	$V_{SENSE\_} - V_{MON\_} = 20mV$	-3.14		+3.19	
		$V_{SENSE\_} - V_{MON\_} = 80mV$	-3.80		+3.93	
Fast Current-Limit Threshold Error (25mV Range)	$V_{MON\_} = 0V$	Circuit breaker, DAC = 102	-2.106		+0.888	mV
		Circuit breaker, DAC = 255	-2.986		+0.641	
	$V_{MON\_} = 2.5V$ to $16V$	Circuit breaker, DAC = 102	-3.000		+1.000	
		Circuit breaker, DAC = 255	-3.500		+1.500	
Fast Current-Limit Threshold Error (50mV Range)	$V_{MON\_} = 0V$	Circuit breaker, DAC = 102	-3.1188		+0.926	mV
		Circuit breaker, DAC = 255	-4.873		+0.3421	
	$V_{MON\_} = 2.5V$ to $16V$	Circuit breaker, DAC = 102	-3.2668		+0.9228	
		Circuit breaker, DAC = 255	-4.7		+1.0212	
Fast Current-Limit Threshold Error (100mV Range)	$V_{MON\_} = 0V$	Circuit breaker, DAC = 102	-4.7987		+1.1812	mV
		Circuit breaker, DAC = 255	-8.9236		+0.202	
	$V_{MON\_} = 2.5V$ to $16V$	Circuit breaker, DAC = 102	-4.9991		+0.6374	
		Circuit breaker, DAC = 255	-8.262		+1	
Slow Current-Limit Threshold Error (25mV Range)	$V_{MON\_} = 0V$	Circuit breaker, DAC = 102	-1.7965		+1.5496	mV
		Circuit breaker, DAC = 255	-1.86		+1.5916	
	$V_{MON\_} = 2.5V$ to $16V$	Circuit breaker, DAC = 102	-2.149		+1.9868	
		Circuit breaker, DAC = 255	-2.2285		+1.9982	
Slow Current-Limit Threshold Error (50mV Range)	$V_{MON\_} = 0V$	Circuit breaker, DAC = 102	-2.3992		+1.8723	mV
		Circuit breaker, DAC = 255	-2.5146		+2.1711	
	$V_{MON\_} = 2.5V$ to $16V$	Circuit breaker, DAC = 102	-2.4716		+2.181	
		Circuit breaker, DAC = 255	-2.7421		+2.1152	
Slow Current-Limit Threshold Error (100mV Range)	$V_{MON\_} = 0V$	Circuit breaker, DAC = 102	-3.3412		+2.989	mV
		Circuit breaker, DAC = 255	-3.8762		+3.6789	
	$V_{MON\_} = 2.5V$ to $16V$	Circuit breaker, DAC = 102	-3.2084		+2.7798	
		Circuit breaker, DAC = 255	-3.8424		+2.6483	
Fast Circuit-Breaker Response Time	t <sub>FCB</sub>	Overdrive = 10% of current-sense range		2		μs
Slow Current-Limit Response Time	t <sub>SCB</sub>	Overdrive = 4% of current-sense range		2.4		ms
		Overdrive = 8% of current-sense range		1.2		
		Overdrive = 16% of current-sense range		0.6		
<b>THREE-STATE INPUTS</b>						
A <sub>-</sub> , IRNG <sub>-</sub> , MODE, PROT Low Current	I <sub>IN_LOW</sub>	Input voltage = 0.4V	-40			μA
A <sub>-</sub> , IRNG <sub>-</sub> , MODE, PROT High Current	I <sub>IN_HIGH</sub>	Input voltage = V <sub>REG</sub> - 0.2V			40	μA
A <sub>-</sub> , IRNG <sub>-</sub> , MODE, PROT Open Current	I <sub>FLOAT</sub>	Maximum source/sink current for open state	-4		+4	μA

# 0V to 16V, Dual Hot-Swap Controller with 10-Bit Current and Voltage Monitor and 4 LED Drivers

## ELECTRICAL CHARACTERISTICS (continued)

(VIN = 2.7V to 16V, TA = -40°C to +85°C, unless otherwise noted. Typical values are at VIN = 3.3V and TA = +25°C.) (Note 2)

PARAMETER	SYMBOL	CONDITIONS	MIN	TYP	MAX	UNITS
A_, IRNG_, MODE, PROT Low Voltage		Relative to AGND			0.4	V
A_, IRNG_, MODE, PROT High Voltage		Relative to REG	-0.24			V
<b>TWO-STATE INPUTS</b>						
ON_ Input Voltage	VON_		0.582	0.592	0.602	V
ON_ Input Hysteresis	VON_HYS			4		%
ON_ Input Current			-100		+100	nA
<b>TIMING</b>						
MON_ to PG_ Delay		Register configurable (see Tables 31a and 31b)	50			ms
			100			
			200			
			400			
<b>CHARGE PUMP (GATE_)</b>						
Charge-Pump Output Voltage		Relative to MON_, IGATE = 0	4.5	5.1	5.5	V
Charge-Pump Output Source Current	IG(UP)		4	5	6	μA
GATE_ Discharge Current	IG(DN)	VGATE_ - VMON_ = 2V		500		mA
<b>OUTPUT (FAULT_, PG_, ALERT)</b>						
Output-Voltage Low		ISINK = 3.2mA			0.2	V
Output Leakage Current					1	μA
<b>LED INPUT/OUTPUT</b>						
LED_ Input Threshold Low Level	VIL				0.4	V
LED_ Input Threshold High Level	VIH		1.4			V
LED_ Output Low	VOL	ILED_ = 25mA			0.7	V
LED_ Input Leakage Current (Open Drain)	IGPIO_IX	VLED_ = 16V	-1		+1	μA
LED_ Weak Pullup Current	I <sub>PU_WEAK</sub>	VLED_ = VIN - 0.65V	2			μA
<b>ADC PERFORMANCE</b>						
Resolution				10		Bits
Maximum Integral Nonlinearity	INL			1		LSB
ADC Total Monitoring Cycle Time		Two voltage and two current-sense conversion	95	100	110	μs
MON_ LSB Voltage		16V range	15.23	15.49	15.69	mV
		8V range	7.655	7.743	7.811	
		4V range	3.811	3.875	3.933	
		2V range	1.899	1.934	1.966	
MON_ Code 000H to 001H Transition Voltage		16V range	10	25	41	mV
		8V range	4.7	12	21	
		4V range	2	6	12	
		2V range	0.5	3	5.5	

# 0V to 16V, Dual Hot-Swap Controller with 10-Bit Current and Voltage Monitor and 4 LED Drivers

## ELECTRICAL CHARACTERISTICS (continued)

( $V_{IN} = 2.7V$  to  $16V$ ,  $T_A = -40^{\circ}C$  to  $+85^{\circ}C$ , unless otherwise noted. Typical values are at  $V_{IN} = 3.3V$  and  $T_A = +25^{\circ}C$ .) (Note 2)

PARAMETER	SYMBOL	CONDITIONS	MIN	TYP	MAX	UNITS
<b>I<sup>2</sup>C INTERFACE</b>						
Serial-Clock Frequency	f <sub>SCL</sub>				400	kHz
Bus Free Time Between STOP and START Condition	t <sub>BUF</sub>		1.3			μs
START Condition Setup Time	t <sub>SU:STA</sub>		0.6			μs
START Condition Hold Time	t <sub>HD:STA</sub>		0.6			μs
STOP Condition Setup Time	t <sub>SU:STO</sub>		0.6			μs
Clock High Period	t <sub>HIGH</sub>		0.6			μs
Clock Low Period	t <sub>LOW</sub>		1.3			μs
Data Setup Time	t <sub>SU:DAT</sub>		100			ns
Data Hold Time	t <sub>HD:DAT</sub>	Transmit	100			ns
		Receive	300	900		
Output Fall Time	t <sub>OF</sub>	C <sub>BUS</sub> = 10pF to 400pF			250	ns
Pulse Width of Spike Suppressed	t <sub>SP</sub>			50		ns
SDA, SCL Input High Voltage	V <sub>IH</sub>		1.8			V
SDA, SCL Input Low Voltage	V <sub>IL</sub>				0.8	V
SDA, SCL Input Hysteresis	V <sub>HYST</sub>			0.22		V
SDA, SCL Input Current			-1		+1	μA
SDA, SCL Input Capacitance				15		pF
SDA Output Voltage	V <sub>OL</sub>	I <sub>SINK</sub> = 4mA			0.4	V

**Note 2:** All devices are 100% production tested at  $T_A = +25^{\circ}C$ . Limits over the temperature range are guaranteed by design.

## Typical Operating Characteristics

( $V_{IN} = 3.3V$ ,  $T_A = +25^{\circ}C$ , unless otherwise noted.)

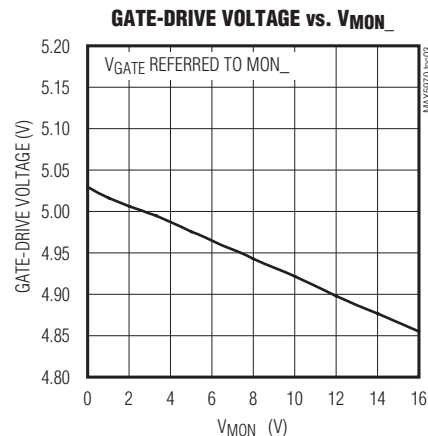
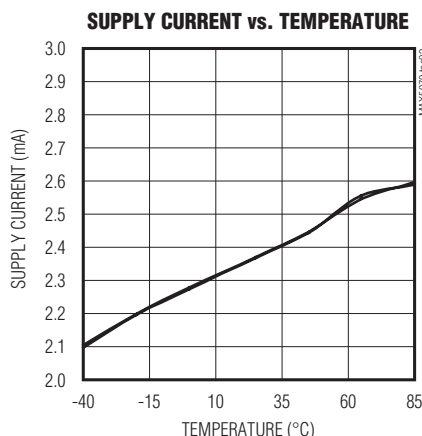
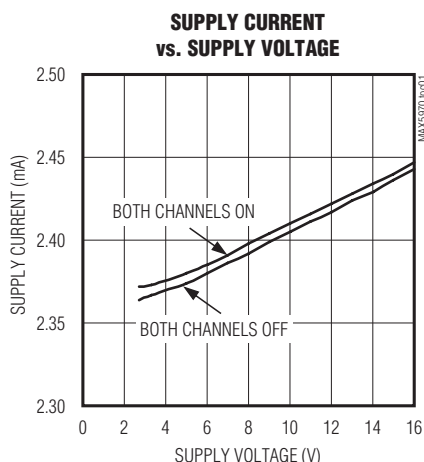

# 0V to 16V, Dual Hot-Swap Controller with 10-Bit Current and Voltage Monitor and 4 LED Drivers

## Typical Operating Characteristics (continued)

( $V_{IN} = 3.3V$ ,  $T_A = +25^\circ C$ , unless otherwise noted.)

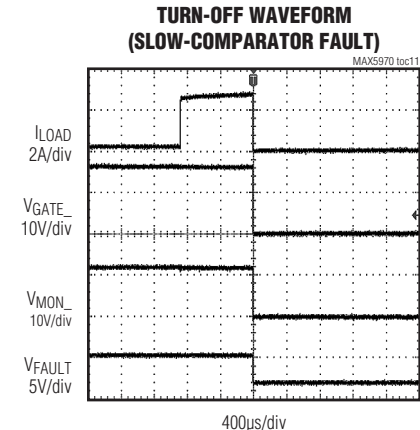
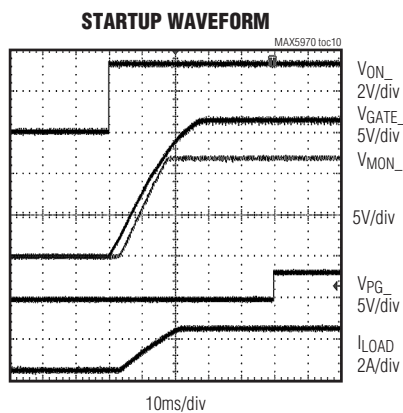
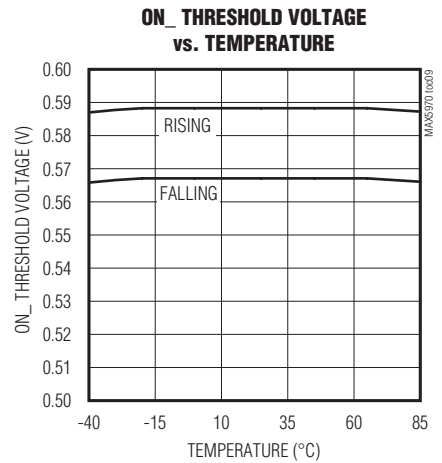
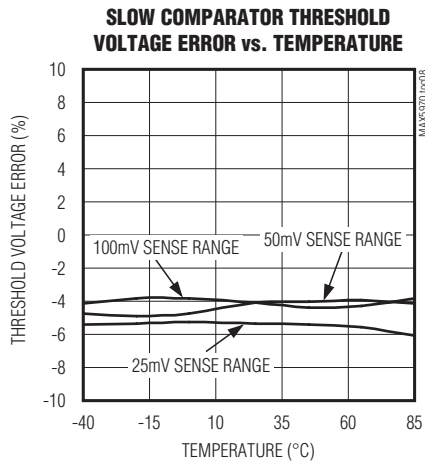
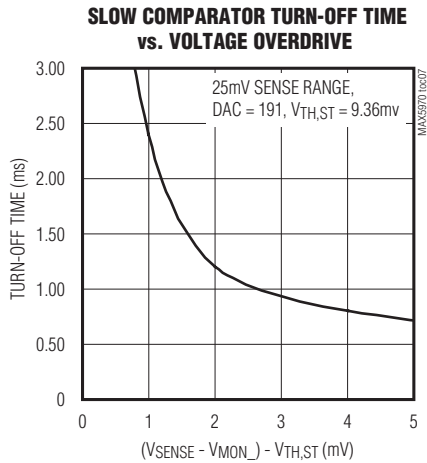
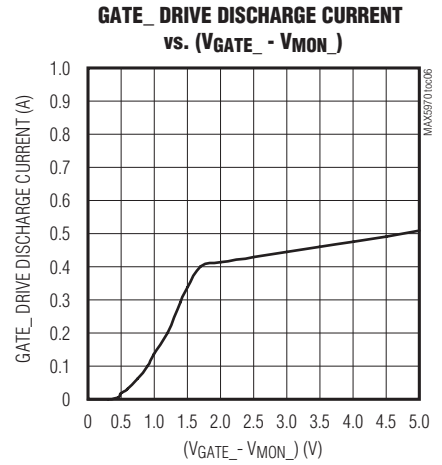
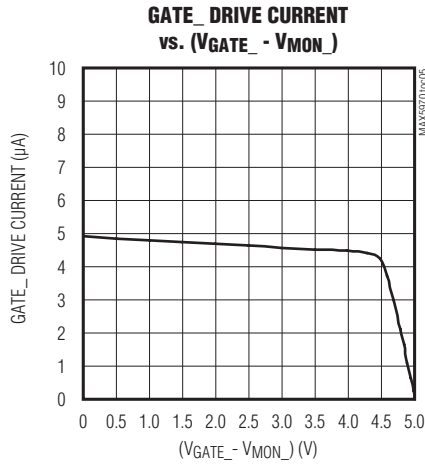
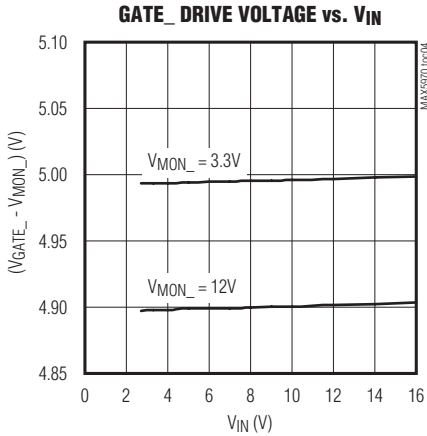

# 0V to 16V, Dual Hot-Swap Controller with 10-Bit Current and Voltage Monitor and 4 LED Drivers

## Typical Operating Characteristics (continued)

( $V_{IN} = 3.3V$ ,  $T_A = +25^\circ C$ , unless otherwise noted.)

**TURN-OFF WAVEFORM  
(FAST COMPARATOR  
FAULT/SHORT-CIRCUIT RESPONSE)**

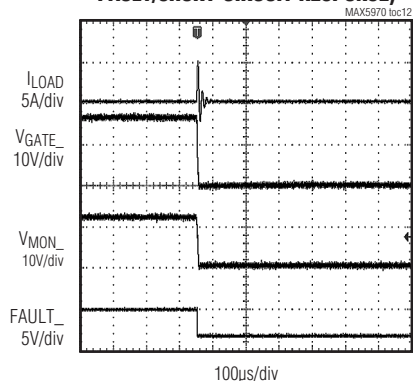

**VOLTAGE BUFFER vs. TIME**

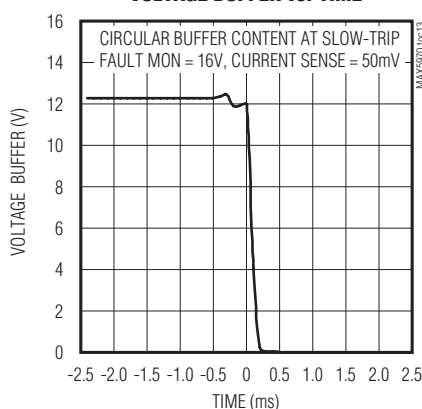

**SLOW-COMPARATOR FAULT EVENT**

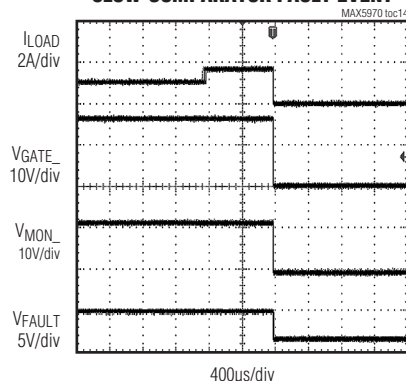

**VOLTAGE ADC ACCURACY  
vs. MON\_ VOLTAGE**

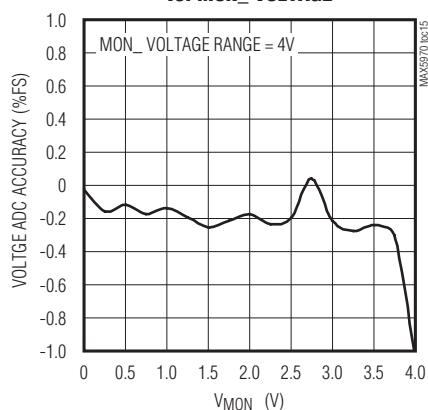

**CURRENT ADC ACCURACY  
vs. (VSENSE\_ - VMON\_)**

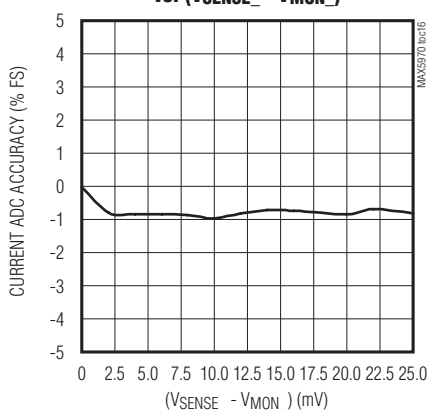

**CURRENT BUFFER vs. TIME**

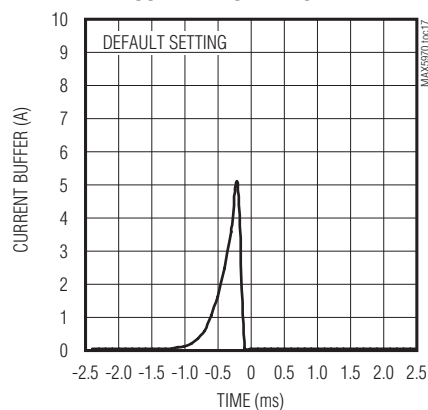

**VOLTAGE BUFFER vs. TIME**

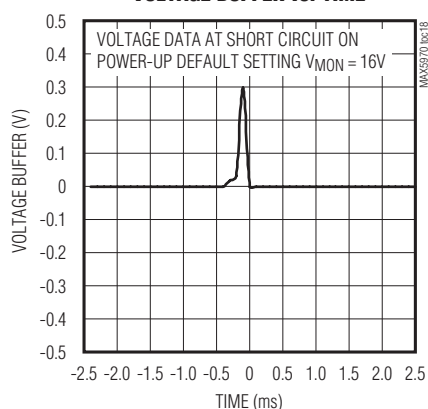

**STARTUP INTO SHORT LOAD**

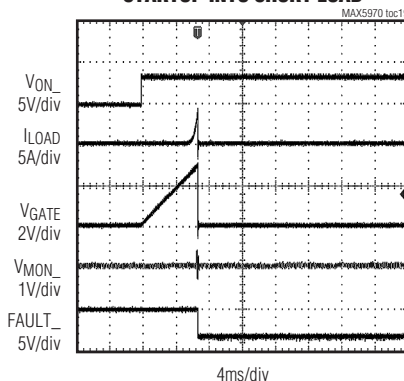

**INPUT LEAKAGE CURRENT  
vs. MON\_ VOLTAGE**

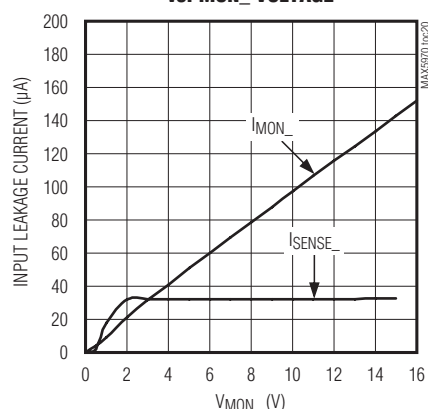

# 0V to 16V, Dual Hot-Swap Controller with 10-Bit Current and Voltage Monitor and 4 LED Drivers

## Pin Configuration

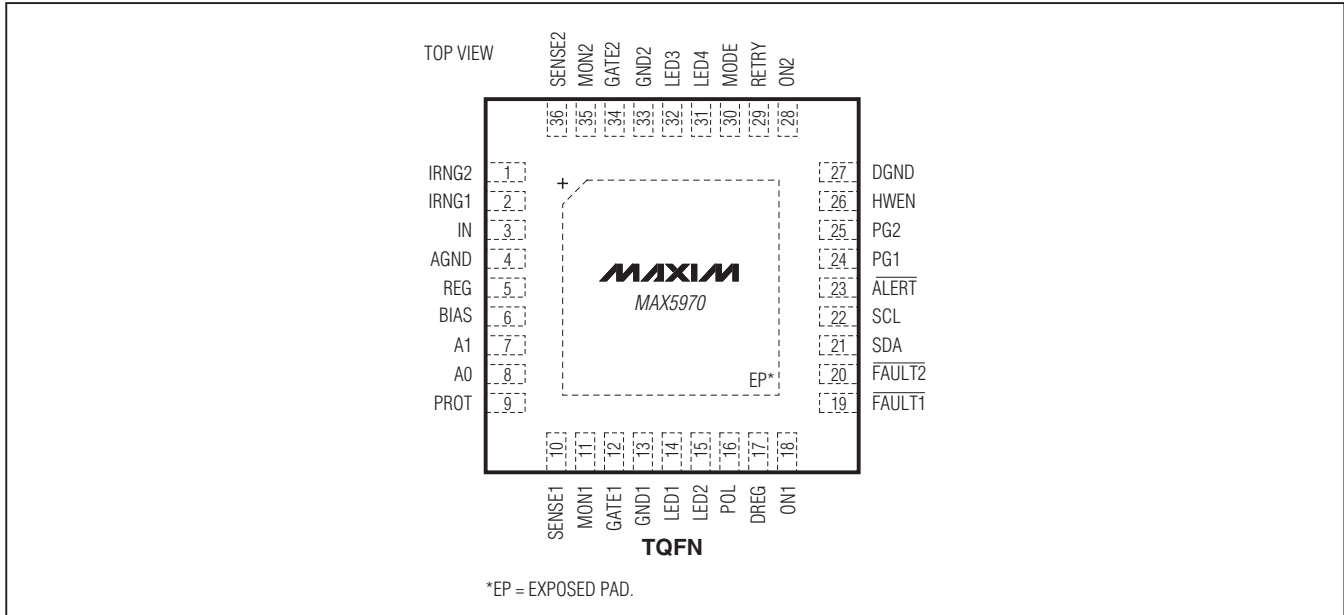

## Pin Description

PIN	NAME	FUNCTION
1	IRNG2	Channel 2 Three-State Current-Sense Range Selection Input. Set the circuit-breaker threshold range by connecting to DGND, DREG, or leave unconnected.
2	IRNG1	Channel 1 Three-State Current-Sense Range Selection Input. Set the circuit-breaker threshold range by connecting to DGND, DREG, or leave unconnected.
3	IN	Power-Supply Input. Connect to a voltage from 2.7V to 16V. Bypass to AGND with a 1µF capacitor.
4	AGND	Analog Ground. Connect all GND_ and DGND to AGND externally using a star connection.
5	REG	Internal Regulator Output. Bypass to ground with a 1µF capacitor. Connect only to DREG. Do not use to power external circuitry.
6	BIAS	For normal operation, connect BIAS to REG.
7	A1	Three-State I <sup>2</sup> C Address Input 1
8	A0	Three-State I <sup>2</sup> C Address Input 0
9	PROT	Protection Behavior Input. Three-state input sets one of three different response options for undervoltage and overvoltage events.
10	SENSE1	Channel 1 Current-Sense Input. Connect SENSE1 to the source of an external MOSFET and to one end of RSENSE1.
11	MON1	Channel 1 Voltage Monitoring Input
12	GATE1	Channel 1 Gate-Drive Output. Connect to the gate of an external n-channel MOSFET.
13	GND1	Channel 1 Gate Discharge Current Ground Return. Connect all GND_ and DGND to AGND externally using a star connection.

# 0V to 16V, Dual Hot-Swap Controller with 10-Bit Current and Voltage Monitor and 4 LED Drivers

## Pin Description (continued)

PIN	NAME	FUNCTION
14	LED1	LED Driver 1
15	LED2	LED Driver 2
16	POL	Polarity Select Input. Connect to DREG for active-high power-good outputs (PG <sub>+</sub> ). Connect to GND for active-low power-good outputs.
17	DREG	Logic Power-Supply Input. Connect to REG externally through a 10Ω resistor and to DGND with a 1μF ceramic capacitor.
18	ON1	Channel 1 Precision Turn-On Input
19	FAULT1	Channel 1 Active-Low Open-Drain Fault Output. FAULT1 goes low if an overcurrent occurs on channel 1.
20	FAULT2	Channel 2 Active-Low Open-Drain Fault Output. FAULT2 goes low if an overcurrent occurs on channel 2.
21	SDA	I <sup>2</sup> C Serial-Data Input/Output
22	SCL	I <sup>2</sup> C Serial-Clock Input
23	ALERT	Open-Drain Alert Output. ALERT goes low during a fault to notify the system of an impending failure.
24	PG1	Channel 1 Open-Drain Power-Good Output
25	PG2	Channel 2 Open-Drain Power-Good Output
26	HWEN	Hardware Enable Input. Connect to DREG or DGND. State is read upon power-up as V <sub>IN</sub> crosses the UVLO threshold and sets enable register bits with this value. After UVLO, this input becomes inactive until power is cycled.
27	DGND	Digital Ground. Connect all GND <sub>+</sub> and DGND to AGND externally using a star connection.
28	ON2	Channel 2 Precision Turn-On Input
29	RETRY	Autoretry Fault Management Input. Connect to DREG to enable autoretry operation. Connect to DGND to enable latched-off operation.
30	MODE	Hot-Swap Two-State Mode Select Input. Connect MODE to DGND, DREG or leave it unconnected to operate the hot-swap channels independently or as a pair.
31	LED4	LED Driver 4
32	LED3	LED Driver 3
33	GND2	Channel 2 Gate Discharge Current Ground Return. Connect all GND <sub>+</sub> and DGND to AGND externally using a star connection.
34	GATE2	Channel 2 Gate-Drive Output. Connect to gate of an external n-channel MOSFET.
35	MON2	Channel 2 Voltage Monitoring Input
36	SENSE2	Channel 2 Current-Sense Input. Connect SENSE2 to the source of an external MOSFET and to one end of R <sub>SENSE2</sub> .
—	EP	Exposed Pad. EP is internally grounded. Connect externally to ground plane using a star connection.

# 0V to 16V, Dual Hot-Swap Controller with 10-Bit Current and Voltage Monitor and 4 LED Drivers

## Typical Application Circuit

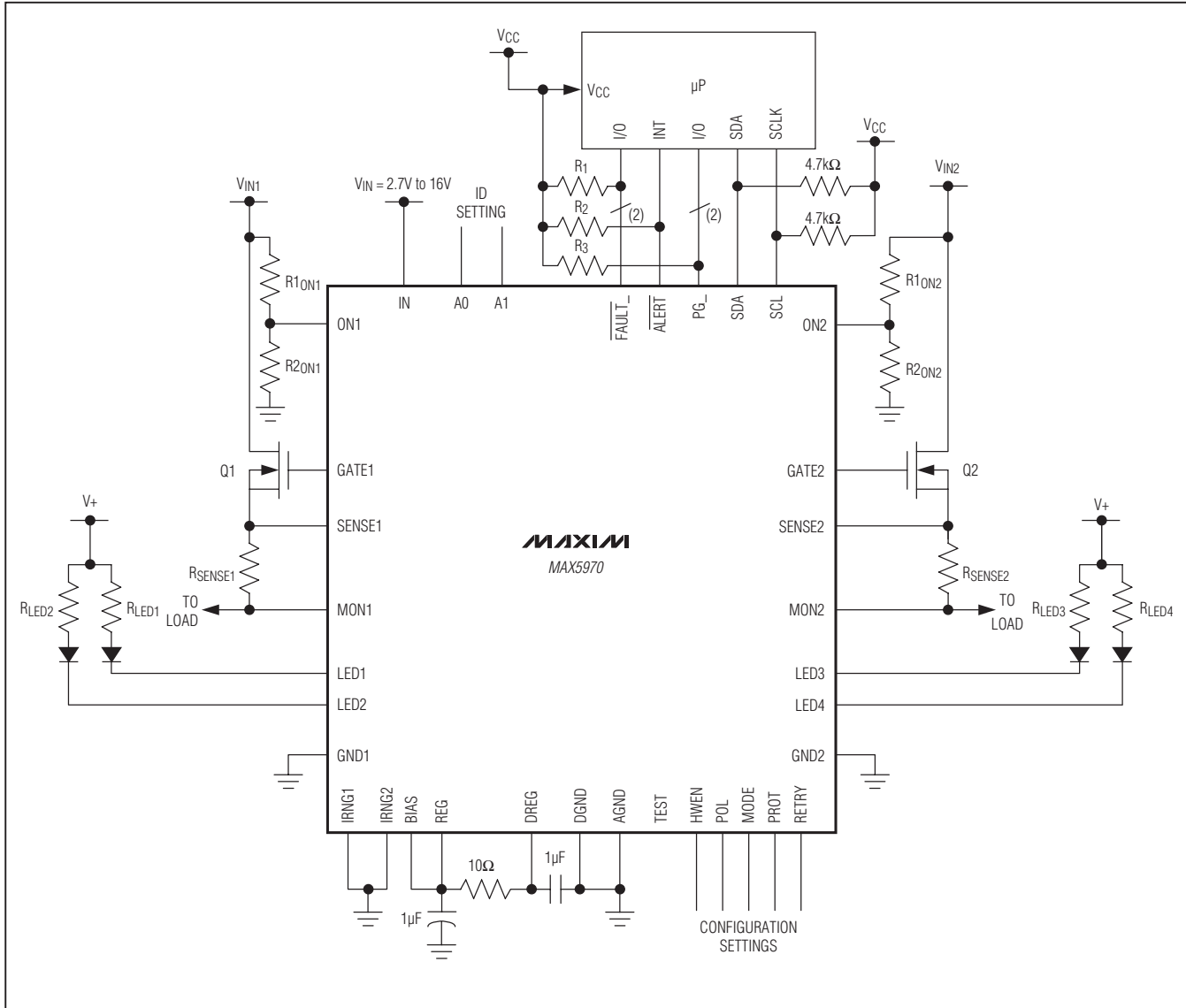

# 0V to 16V, Dual Hot-Swap Controller with 10-Bit Current and Voltage Monitor and 4 LED Drivers

Block Diagram

MAX5970

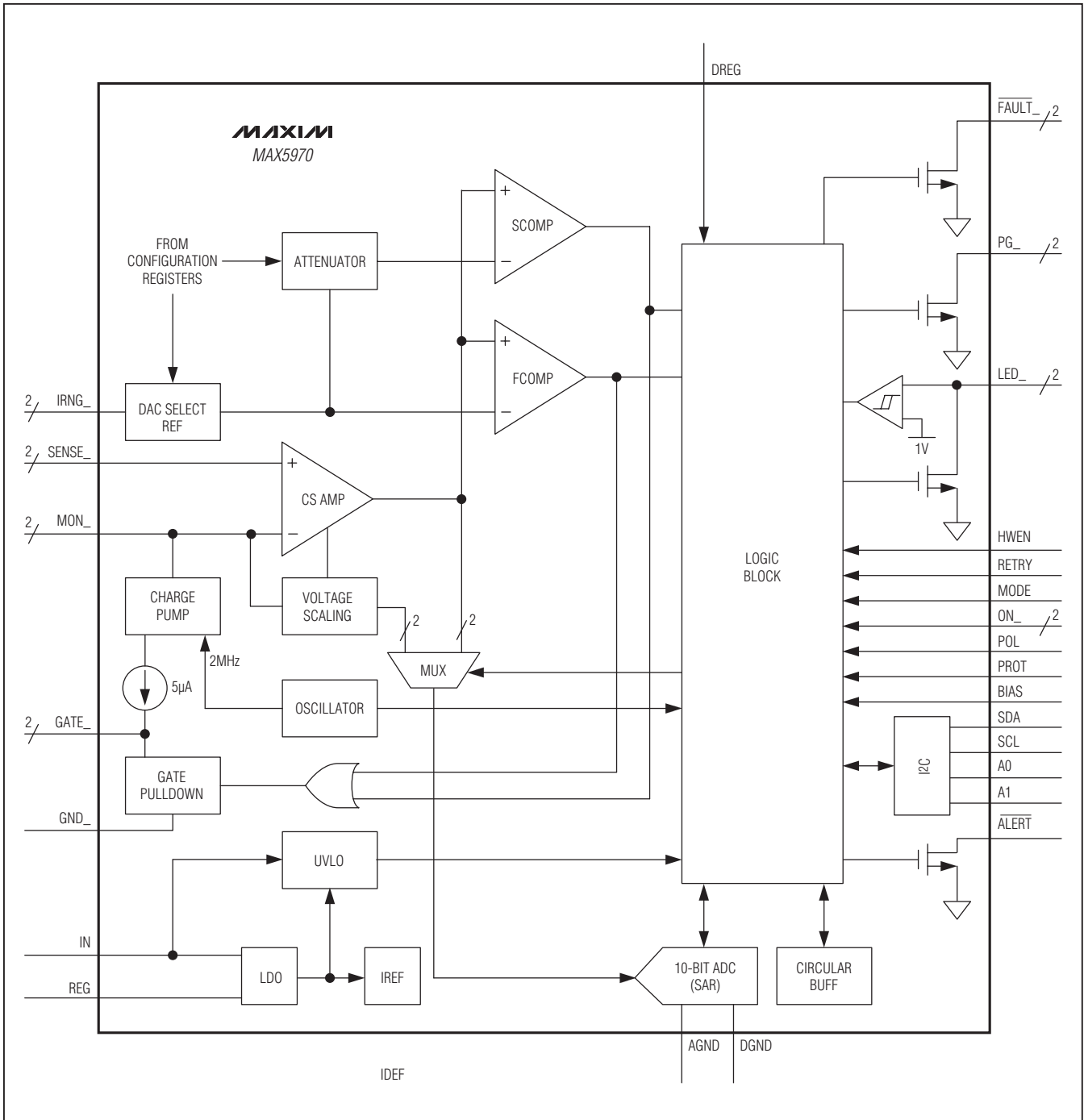

# 0V to 16V, Dual Hot-Swap Controller with 10-Bit Current and Voltage Monitor and 4 LED Drivers

## Detailed Description

The MAX5970 includes a set of registers that are accessed through the I<sup>2</sup>C interface. Some of the registers

are read only and some of the registers are read and write that are updated to configure the MAX5970 for a specific operation. See Tables 1a and 1b for the registers map.

**Table 1a. Register Address Map (Channel Specific)**

REGISTER	DESCRIPTION	CHANNEL 1	CHANNEL 2	RESET VALUE	READ/ WRITE
adc_chx_cs_msb	High 8 bits ([9:2]) of latest current-signal ADC result	0x00	0x04	—	R
adc_chx_cs_lsb	Low 2 bits ([1:0]) of latest current-signal ADC result	0x01	0x05	—	R
adc_chx_mon_msb	High 8 bits ([9:2]) of latest voltage-signal ADC result	0x02	0x06	—	R
adc_chx_mon_lsb	Low 2 bits ([1:0]) of latest voltage-signal ADC result	0x03	0x07	—	R
min_chx_cs_msb	High 8 bits ([9:2]) of current-signal minimum value	0x08	0x10	0xFF	R
min_chx_cs_lsb	Low 2 bits ([1:0]) of current-signal minimum value	0x09	0x11	0x03	R
max_chx_cs_msb	High 8 bits ([9:2]) of current-signal maximum value	0x0A	0x12	0x00	R
max_chx_cs_lsb	Low 2 bits ([1:0]) of current-signal maximum value	0x0B	0x13	0x00	R
min_chx_mon_msb	High 8 bits ([9:2]) of voltage-signal minimum value	0x0C	0x14	0xFF	R
min_chx_mon_lsb	Low 2 bits ([1:0]) of voltage-signal minimum value	0x0D	0x15	0x03	R
max_chx_mon_msb	High 8 bits ([9:2]) of voltage-signal maximum value	0x0E	0x16	0x00	R
max_chx_mon_lsb	Low 2 bits ([1:0]) of voltage-signal maximum value	0x0F	0x17	0x00	R
uv1thr_chx_msb	High 8 bits ([9:2]) of undervoltage warning (UV1) threshold	0x1A	0x24	0x00	R/W
uv1thr_chx_lsb	Low 2 bits ([1:0]) of undervoltage warning (UV1) threshold	0x1B	0x25	0x00	R/W
uv2thr_chx_msb	High 8 bits ([9:2]) of undervoltage critical (UV2) threshold	0x1C	0x26	0x00	R/W
uv2thr_chx_lsb	Low 2 bits ([1:0]) of undervoltage critical (UV2) threshold	0x1D	0x27	0x00	R/W
ov1thr_chx_msb	High 8 bits ([9:2]) of overvoltage warning (OV1) threshold	0x1E	0x28	0xFF	R/W
ov1thr_chx_lsb	Low 2 bits ([1:0]) of overvoltage warning (OV1) threshold	0x1F	0x29	0x03	R/W

# 0V to 16V, Dual Hot-Swap Controller with 10-Bit Current and Voltage Monitor and 4 LED Drivers

**Table 1a. Register Address Map (Channel Specific) (continued)**

REGISTER	DESCRIPTION	CHANNEL 1	CHANNEL 2	RESET VALUE	READ/ WRITE
ov2thr_chx_msb	High 8 bits ([9:2]) of overvoltage critical (OV2) threshold	0x20	0x2A	0xFF	R/W
ov2thr_chx_lsb	Low 2 bits ([1:0]) of overvoltage critical (OV2) threshold	0x21	0x2B	0x03	R/W
oithr_chx_msb	High 8 bits ([9:2]) of overcurrent warning threshold	0x22	0x2C	0xFF	R/W
oithr_chx_lsb	Low 2 bits ([1:0]) of overcurrent warning threshold	0x23	0x2D	0x03	R/W
dac_chx-fast	Fast-comparator threshold DAC setting	0x2E	0x2F	0xBF	R/W
cubf_ba_chx_v	Base address for block read of 50-sample voltage-signal data buffer	0x46	0x48	—	R
cubf_ba_chx_i	Base address for block read of 50-sample current-signal data buffer	0x47	0x49	—	R

**Table 1b. Register Address Map (General)**

REGISTER	DESCRIPTION	ADDRESS (HEX CODE)	RESET VALUE	READ/ WRITE
mon_range	MON input range setting	0x18	0x00	R/W
cbuf_chx_store	Selective enabling of circular buffer	0x19	0x0F	R/W
ifast2slow	Current threshold fast-to-slow ratio setting	0x30	0x0F	R/W
status0	Slow-trip and fast-trip comparators status register	0x31	0x00	R
status1	PROT, MODE, and ON_ inputs status register	0x32	—	R
status2	Fast-trip threshold maximum range setting bits, from IRNG_ three-state inputs	0x33	—	R/W
status3	LATCH, POL, ALERT, and PG_ status register	0x34	—	R
fault0	Status register for undervoltage detection (warning or critical)	0x35	0x00	R/C
fault1	Status register for overvoltage detection (warning or critical)	0x36	0x00	R/C
fault2	Status register for overcurrent detection (warning)	0x37	0x00	R/C
pgdly	Delay setting between MON measurement and PG_ assertion	0x38	0x00	R/W
fokey	Load register with 0xA5 to enable force-on function	0x39	0x00	R/W
foset	Register that enables force-on function for a channel	0x3A	0x00	R/W
chxen	Channel enable bits	0x3B	—	R/W
dgl_i	OC deglitch enable bits	0x3C	0x00	R/W
dgl_uv	UV deglitch enable bits	0x3D	0x00	R/W
dgl_ov	OV deglitch enable bits	0x3E	0x00	R/W
cbufrd_hibyonly	Circular buffers readout mode: 8 bit or 10 bit	0x3F	0x0F	R/W
cbuf_dly_stop	Circular buffer stop-delay. Number of samples recorded to the circular buffer after channel shutdown.	0x40	0x19	R/W
peak_log_rst	Reset control bits for peak-detection registers	0x41	0x00	R/W
peak_log_hold	Hold control bits for peak-detection registers	0x42	0x00	R/W

# 0V to 16V, Dual Hot-Swap Controller with 10-Bit Current and Voltage Monitor and 4 LED Drivers

Table 1b. Register Address Map (General) (continued)

REGISTER	DESCRIPTION	ADDRESS (HEX CODE)	RESET VALUE	READ/ WRITE
LED_Flash	LED flash/GPIO enable register	0x43	0x00	R/W
LED_ph_pu	LED phase/weak pullup enable register	0x44	0x00	R/W
LED_state	LED pins voltage state register (LED pins set open)	0x45	0x00	R

### Grouping Hot-Swap Channels

The MAX5970 can operate as either two independent hot-swap controllers or as a pair. See Table 2 for the configuration option based on the MODE logic level.

### Hot-Swap Channels On-Off Control

Depending on the configuration of the Chx\_EN1 and Chx\_EN2 bits, when VIN is above the VUVLO threshold and the ON\_ input reaches its internal threshold, the MAX5970 turns on the external n-channel MOSFET for the corresponding channel, allowing power to flow to the load. The channel is enabled depending on the output of a majority function. Chx\_EN1, Chx\_EN2, and ON\_ are the inputs to the majority function and the channel is enabled when two or more of these inputs are 1.

$$(\text{Channel enabled}) = (\text{Chx\_EN1} \times \text{Chx\_EN2}) + (\text{Chx\_EN1} \times \text{ON\_}) + (\text{Chx\_EN2} \times \text{ON\_})$$

The inputs ON\_ and Chx\_EN2 can be set externally; the initial state of the Chx\_EN2 bits in register *chxen* is set by the state of the HWEN input when VIN rises above VUVLO. The ON\_ inputs connect to internal precision analog comparators with a 0.6V threshold. Whenever VON\_ is above 0.6V, the corresponding ON\_ bit in register *status1[0:1]* is set to 1. The inputs Chx\_EN1 and Chx\_EN2 can be set using the I<sup>2</sup>C interface; the Chx\_EN1 bits have a default value of 0. This makes it possible to enable or disable each of the MAX5970 channels independently with or without using the I<sup>2</sup>C interface (see Tables 3, 4a, and 4b).

Table 2. Grouping Hot-Swap Channels

MODE INPUT	FUNCTION	DESCRIPTION
Low	Independent	Each channel operates as an independent hot-swap controller. A fault shutdown in one channel does not affect operation of other channel.
High/unconnected	Paired	Channel 0 and channel 1 operate together as one pair. A fault shutdown in one channel shuts down both channels in the pair. Both channels share the ADC monitoring capability.

Table 3. chxen Register Format

Description:		Channel enable bits, from HWEN input and Chx_EN1 bits						
Register Title:		chxen						
Register Address:		0x3B						
R/W	R/W	R/W	R/W	R/W	R/W	R/W	R/W	RESET VALUE
				Ch2_EN2	Ch2_EN1	Ch1_EN2	Ch1_EN1	—
bit 7	bit 6	bit 5	bit 4	bit 3	bit 2	bit 1	bit 0	

# 0V to 16V, Dual Hot-Swap Controller with 10-Bit Current and Voltage Monitor and 4 LED Drivers

Table 4a. status1 Register Function

REGISTER ADDRESS	BIT RANGE	DESCRIPTION
0x32	[1:0]	<b>ON_ Inputs State</b> 1 = ON_ above 600mV channel enable threshold 0 = ON_ below 600mV channel enable threshold Bit 0: ON1 Bit 1: ON2
	[4]	<b>Channel Grouping Mode (MODE Input)</b> 0 = Grouped (MODE high or open) 1 = Independent (MODE low)
	[7:6]	<b>Voltage Critical Behavior (PROT Input)</b> 00 = Assert $\overline{\text{ALERT}}$ upon UV/OV critical (same as UV/OV warning behavior) 01 = Assert $\overline{\text{ALERT}}$ and deassert PG_ upon UV/OV critical 10 = Assert $\overline{\text{ALERT}}$ , deassert PG_, and shutdown channel(s) upon UV/OV critical 11 = (Not possible)

Table 4b. status1 Register Format

Description:		Channel grouping (three-state MODE input), fault-detection behavior (three-state PROT input), and ON_ inputs status register						RESET VALUE
Register Title:		status1						
Register Address:		0x32						
<b>R</b>	<b>R</b>	<b>R</b>	<b>R</b>	<b>R</b>	<b>R</b>	<b>R</b>	<b>R</b>	
prot[1]	prot[0]	—	mode[0]	—	—	ON2	ON1	0x00
bit 7	bit 6	bit 5	bit 4	bit 3	bit 2	bit 1	bit 0	

Figure 1 shows the detailed logic operation of the hot-swap enable signals Chx\_EN1, Chx\_EN2, and ON\_, as well as the effect of various fault conditions.

An input undervoltage threshold control for enabling the hot-swap channel can be implemented by placing a resistive divider between the drain of the hot-swap MOSFET and ground, with the midpoint connected to ON\_. The turn-on threshold voltage for the channel is then:

$$V_{EN} = 0.6V \times (R1 + R2)/R2$$

The maximum rating for the ON\_ is 6V; do not exceed this value.

### Startup

When all conditions for channel turn-on are met, the external n-channel MOSFET switch is fully enhanced with a typical gate-to-source voltage of 5V to ensure a low drain-to-source resistance. The charge pump at each GATE\_ driver sources 5μA to control the output voltage turn-on voltage slew rate. An external capacitor can be added from GATE\_ to GND\_ to further reduce the voltage slew rate. Placing a 1kΩ resistor in series with this capacitance prevents the added capacitance from increasing the gate turn-off time. Total inrush current is the load current summed with the product of the gate voltage slew rate dV/dt and the load capacitance.

# 0V to 16V, Dual Hot-Swap Controller with 10-Bit Current and Voltage Monitor and 4 LED Drivers

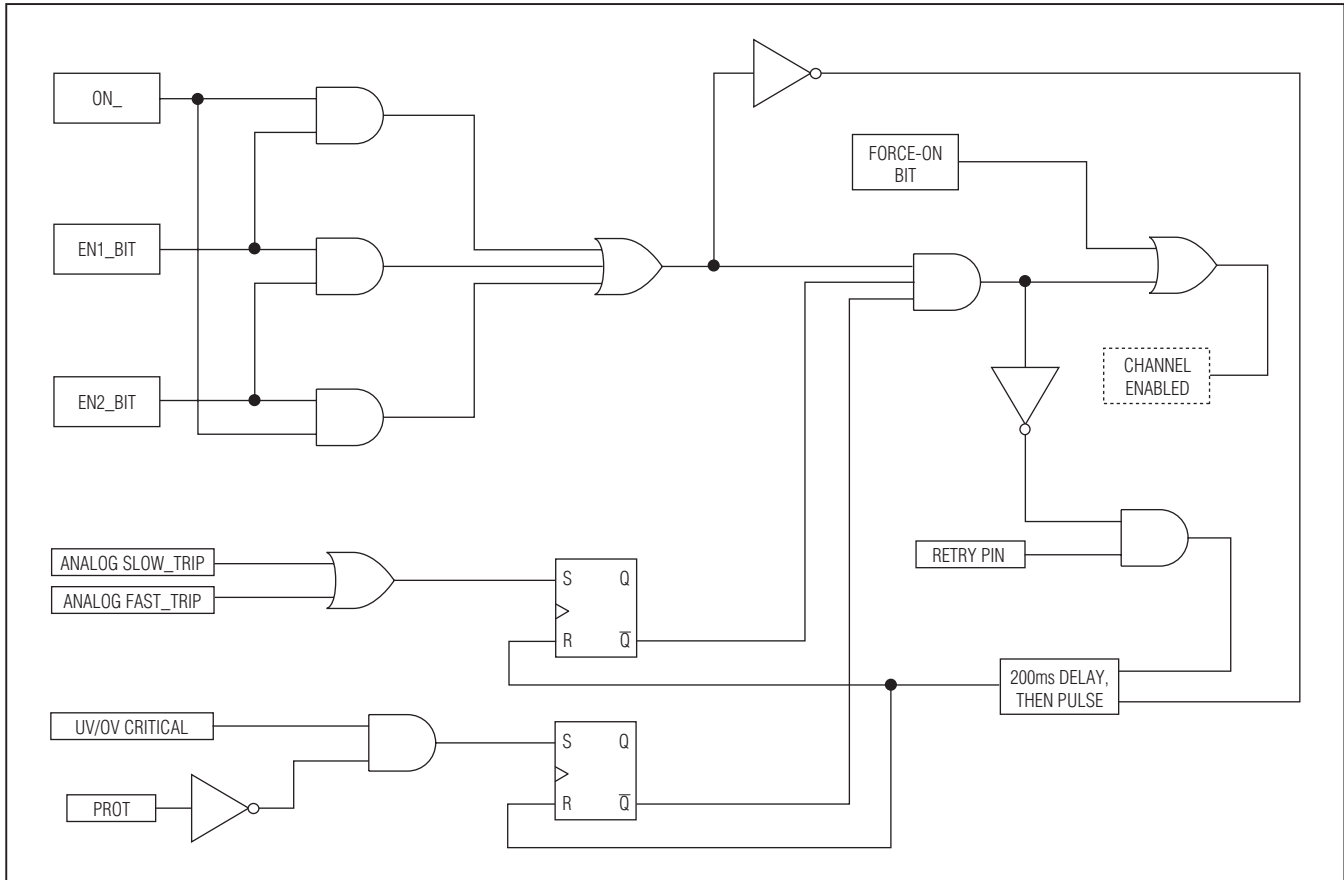

Figure 1. Channel On-Off Control Logic Functional Schematic

To determine the output  $dV/dt$  during startup, divide the GATE\_ pullup current  $I_{G(UP)}$  by the gate-to-ground capacitance. The voltage at the source of the external MOSFET follows the gate voltage, so the load  $dV/dt$  is the same as the gate  $dV/dt$ . Inrush current is the product of the  $dV/dt$  and the load capacitance. The time to start up  $t_{SU}$  is the hot-swap voltage  $V_{S_}$  divided by the output  $dV/dt$ .

Be sure to choose an external MOSFET that can handle the power dissipated during startup. The inrush current is roughly constant during startup, and the voltage drop across the MOSFET (drain to source) decreases linearly as the load capacitance charges. The resulting power dissipation is therefore roughly equivalent to a single pulse of magnitude  $(V_{S_} \times I_{\text{inrush}})/2$  and duration  $t_{SU}$ . Refer to the thermal resistance charts in the MOSFET data sheet to determine the junction temperature rise during startup, and ensure that this does

not exceed the maximum junction temperature for worst-case ambient conditions.

### Circuit-Breaker Protection

As the channel is turned on and during normal operation, two analog comparators are used to detect an overcurrent condition by sensing the voltage across an external resistor connected between SENSE\_ and MON\_. If the voltage across the sense resistor is less than the slow-trip and fast-trip circuit-breaker thresholds, the GATE\_ output remains high. If either of the thresholds is exceeded due to an overcurrent condition, the gate of the MOSFET is pulled down to MON\_ by an internal 500mA current source.

The higher of the two comparator thresholds, the fast-trip, is set by an internal 8-bit DAC (see Table 8), within one of three configurable full-scale current-sense ranges: 25mV, 50mV, or 100mV (see Tables 7a and 7b). The 8-bit fast-trip threshold DAC can be programmed

# 0V to 16V, Dual Hot-Swap Controller with 10-Bit Current and Voltage Monitor and 4 LED Drivers

**Table 5a. ifast2slow Register Format**

Description:		Current threshold fast to slow setting bits							
Register Title:		ifast2slow							
Register Address:		0x30							
R/W	R/W	R/W	R/W	R/W	R/W	R/W	R/W	RESET VALUE	
—	—	—	—	Ch2_FS1	Ch2_FS0	Ch1_FS1	Ch1_FS0	0x0F	
bit 7	bit 6	bit 5	bit 4	bit 3	bit 2	bit 1	bit 0		

**Table 5b. Setting Fast-Trip to Slow-Trip Threshold Ratio**

Chx_FS1	Chx_FS0	FAST-TRIP TO SLOW-TRIP RATIO (%)
0	0	125
0	1	150
1	0	175
1	1	200

from 40% to 100% of the selected full-scale current-sense range. The slow-trip threshold follows the fast-trip threshold as one of four programmable ratios, set by the ifast2slow register (see Tables 5a and 5b).

The fast-trip threshold is always higher than the slow-trip threshold, and the fast-trip comparator responds very quickly to protect the system against sudden, severe overcurrent events. The slower response of the slow-trip comparator varies depending upon the amount of overdrive beyond the slow-trip threshold. If the overdrive is small and short-lived, the comparator does not shut down the affected channel. As the overcurrent event increases in magnitude, the response time of the slow-trip comparator decreases. This scheme provides good rejection of noise and spurious overcurrent transients near the slow-trip threshold while aggressively protecting the system against larger overcurrent events that occur as a result of a load fault.

### Setting Circuit-Breaker Thresholds

To select and set the MAX5970 slow-trip and fast-trip comparator thresholds, use the following procedure:

- 1) Select one of four ratios between the fast-trip threshold and the slow-trip threshold: 200%, 175%, 150%, or 125%. A system that experiences brief, but large transient load currents should use a higher ratio, whereas a system that operates continuously at higher average load currents might benefit from a smaller ratio to ensure adequate protection. The ratio

is set by writing to the ifast2slow register. The default setting on power-up is 200%.

- 2) Determine the slow-trip threshold  $V_{TH,ST}$  based on the anticipated maximum continuous load current during normal operation, and the value of the current-sense resistor. The slow-trip threshold should include some margin (possibly 20%) above the maximum load current to prevent spurious circuit-breaker shutdown and to accommodate passive component tolerances:

$$V_{TH,ST} = R_{SENSE} \times I_{LOAD,MAX} \times 120\%$$

- 3) Calculate the necessary fast-trip threshold  $V_{TH,FT}$  based on the ratio set in step 1:

$$V_{TH,FT} = V_{TH,ST} \times (\text{ifast2slow ratio})$$

- 4) Select one of the four maximum current-sense ranges: 25mV, 50mV, or 100mV. The current-sense range is initially set upon power-up by the state of the associated IRNG\_ input, but can be altered at any time by writing to the status2 register. For maximum accuracy and best measurement resolution, select the lowest current-sense range that is larger than the  $V_{TH,FT}$  value calculated in Step 3.

- 5) Program the fast-trip and slow-trip thresholds by writing an 8-bit value to the dac\_chx register. This 8-bit value is determined from the desired  $V_{TH,ST}$  value that was calculated in Step 2, the threshold ratio from Step 1, and the current-sense range from Step 4:

$$DAC = V_{TH,ST} \times 255 \times (\text{ifast2slow ratio}) / (\text{IRNG_ current-sense range})$$

# 0V to 16V, Dual Hot-Swap Controller with 10-Bit Current and Voltage Monitor and 4 LED Drivers

The MAX5970 provides a great deal of system flexibility because the current-sense range, DAC setting, and threshold ratio can be changed on the fly for systems that must protect a wide range of interchangeable load devices, or for systems that control the allocation of power to smart loads. Table 6 shows the specified

ranges for the fast-trip and slow-trip thresholds for all combinations of current-sense range and threshold ratio. When an overcurrent event causes the MAX5970 to shut down a channel, a corresponding open-drain `FAULT_` output alerts the system. Figure 2 shows the operation and fault-management flowchart for one channel of the MAX5970.

**Table 6. Specified Current-Sense and Circuit-Breaker Threshold Ranges**

IRNG_INPUT	FAST-TRIP DAC OUTPUT RANGE (mV)	GAIN (2-BIT) (VFAST/VLOW) ifast2slow (DEFAULT = 11)	SLOW-TRIP THRESHOLD RANGE (mV)
Low	10 to 25	00 (125%)	8.00 to 20.00
		01 (150%)	6.67 to 16.67
		10 (175%)	5.71 to 14.29
		11 (200%)	5.00 to 12.50
High	20 to 50	00 (125%)	16.00 to 40.00
		01 (150%)	13.33 to 33.33
		10 (175%)	11.48 to 28.57
		11 (200%)	10.00 to 25.00
Unconnected	40 to 100	00 (125%)	32.00 to 80.00
		01 (150%)	26.67 to 66.67
		10 (175%)	22.86 to 57.14
		11 (200%)	20.00 to 50.00

**Table 7a. IRNG Inputs Status Register Format**

Description:		Fast-trip threshold maximum range setting bits, from IRNG_ three-state inputs						
Register Title:		Status 2						
Register Address:		0x33						
				R/W	R/W	R/W	R/W	RESET VALUE
—	—	—	—	CH1_ IRNG1	CH1_ IRNG0	CH0_ IRNG1	CH0_ IRNG0	—
bit 7	bit 6	bit 5	bit 4	bit 3	bit 2	bit 1	bit 0	

**Table 7b. Setting Current-Sense Range**

IRNG_PIN STATE	Chx_IRNG1	Chx_IRNG0	MAXIMUM CURRENT-SENSE SIGNAL (mV)
Low	1	0	25
High	0	1	50
Open	0	0	100

# 0V to 16V, Dual Hot-Swap Controller with 10-Bit Current and Voltage Monitor and 4 LED Drivers

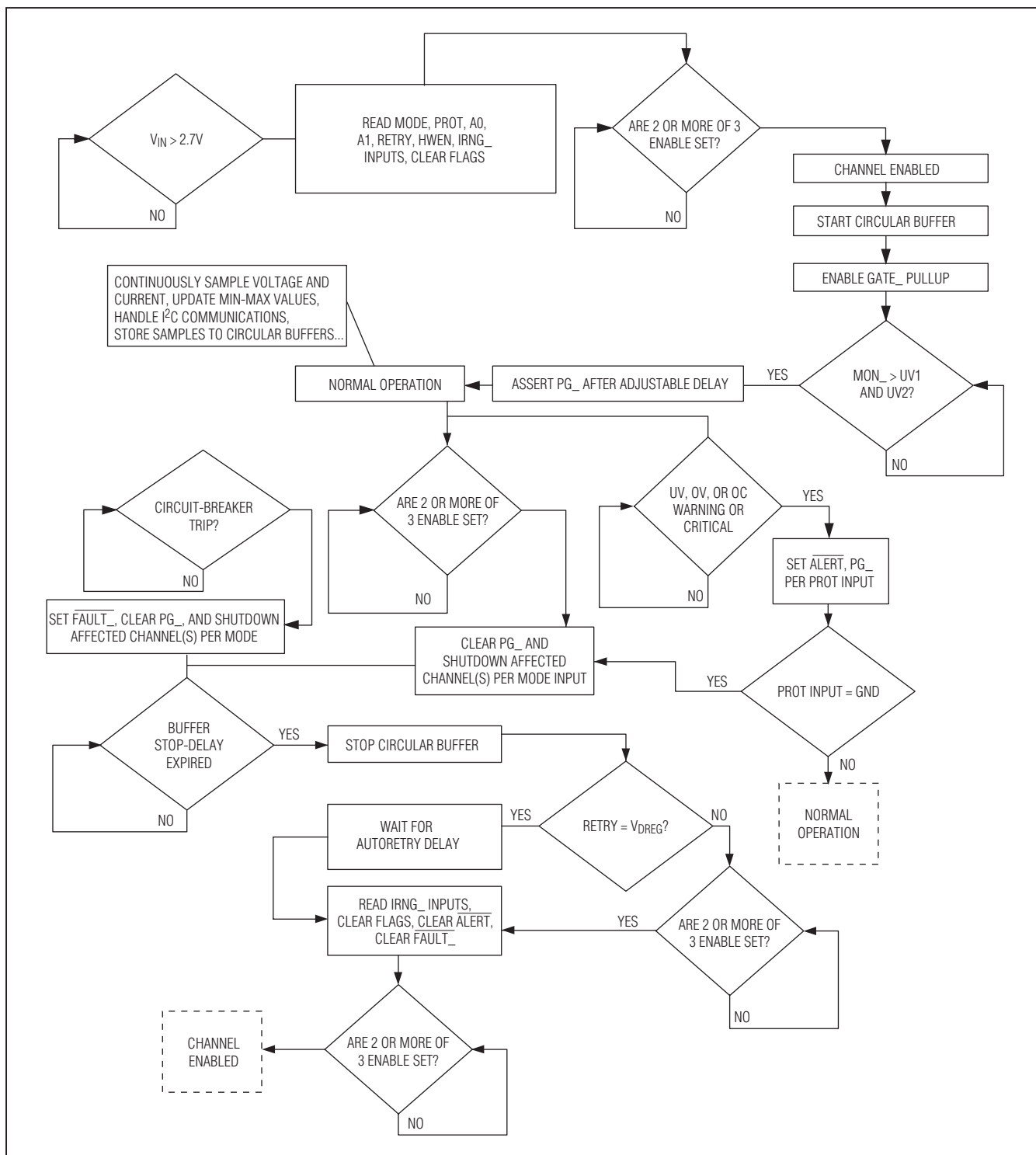

Figure 2. Operation and Fault-Management Flowchart for One Channel

# 0V to 16V, Dual Hot-Swap Controller with 10-Bit Current and Voltage Monitor and 4 LED Drivers

**Table 8. dac\_chx Register Format**

Description:		Fast-comparator threshold DAC setting						
Register Title:		dac_ch0		dac_ch1				
Register Addresses:		0x2E		0x2F				
R/W	R/W	R/W	R/W	R/W	R/W	R/W	R/W	RESET VALUE
DAC[7]	DAC[6]	DAC[5]	DAC[4]	DAC[3]	DAC[2]	DAC[1]	DAC[0]	0xBF
bit 7	bit 6	bit 5	bit 4	bit 3	bit 2	bit 1	bit 0	

### Digital Current Monitoring

The two current-sense signals are sampled by the internal 10-bit 10ksp ADC, and the most recent results are stored in registers for retrieval through the I<sup>2</sup>C interface. The current conversion values are 10 bits wide, with the eight high-order bits written to one 8-bit register and the

two low-order bits written to the next higher 8-bit register address (Tables 9 and 10). This allows use of just the high-order byte in applications where 10-bit precision is not required. This split 8-bit/2-bit storage scheme is used throughout the MAX5970 for all 10-bit ADC conversion results and 10-bit digital comparator thresholds.

**Table 9. ADC Current Conversion Results Register Format (High-Order Bits)**

Description:		Most recent current conversion result, high-order bits [9:2]						
Register Title:		adc_ch0_cs_msb		adc_ch1_cs_msb				
Register Addresses:		0x00		0x04				
R	R	R	R	R	R	R	R	RESET VALUE
inew_9	inew_8	inew_7	inew_6	inew_5	inew_4	inew_3	inew_2	0x00
bit 7	bit 6	bit 5	bit 4	bit 3	bit 2	bit 1	bit 0	

**Table 10. ADC Current Conversion Results Register Format (Low-Order Bits)**

Description:		Most recent current conversion result, low-order bits [0:1]						
Register Title:		adc_ch0_cs_lsb		adc_ch1_cs_lsb				
Register Addresses:		0x01		0x05				
R	R	R	R	R	R	R	R	RESET VALUE
						inew_1	inew_0	0x00
bit 7	bit 6	bit 5	bit 4	bit 3	bit 2	bit 1	bit 0	

# 0V to 16V, Dual Hot-Swap Controller with 10-Bit Current and Voltage Monitor and 4 LED Drivers

Once the PG\_ output is asserted, the most recent current samples are continuously compared to the programmable overcurrent warning register values. If the measured current value exceeds the warning level, the ALERT output is asserted. The MAX5970 response to this digital comparator is not altered by the setting of the PROT input (Tables 11 and 12).

## Minimum and Maximum Value Detection for Current Measurement Values

All current measurement values from the ADC are continuously compared with the contents of minimum-

and maximum-value registers, and if the most recent measurement exceeds the stored maximum or is less than the stored minimum, the corresponding register is updated with the new value. These peak detection registers are read accessible through the I<sup>2</sup>C interface (Tables 13–16). The minimum-value registers are reset to 0x3FF, and the maximum-value registers are reset to 0x000. These reset values are loaded upon startup of a channel or at any time as commanded by register peak\_log\_rst (Table 36).

**Table 11. Overcurrent Warning Threshold Register Format (High-Order Bits)**

Description:		Overcurrent warning threshold high-order bits [9:2]						
Register Title:		oi_ch0_msb		oi_ch1_msb				
Register Addresses:		0x22		0x2C				
R/W	R/W	R/W	R/W	R/W	R/W	R/W	R/W	RESET VALUE
oi_9	oi_8	oi_7	oi_6	oi_5	oi_4	oi_3	oi_2	0xFF
bit 7	bit 6	bit 5	bit 4	bit 3	bit 2	bit 1	bit 0	

**Table 12. Overcurrent Warning Threshold Register Format (Low-Order Bits)**

Description:		Overcurrent warning threshold low-order bits [1:0]						
Register Title:		oi_ch0_lsb		oi_ch1_lsb				
Register Addresses:		0x23		0x2D				
R	R	R	R	R	R	R/W	R/W	RESET VALUE
						oi_1	oi_0	0x03
bit 7	bit 6	bit 5	bit 4	bit 3	bit 2	bit 1	bit 0	

**Table 13. ADC Minimum Current Conversion Register Format (High-Order Bits)**

Description:		Minimum current conversion result high-order bits [9:2]						
Register Title:		min_ch0_cs_msb		min_ch1_cs_msb				
Register Addresses:		0x08		0x10				
R	R	R	R	R	R	R	R	RESET VALUE
imin_9	imin_8	imin_7	imin_6	imin_5	imin_4	imin_3	imin_2	0xFF
bit 7	bit 6	bit 5	bit 4	bit 3	bit 2	bit 1	bit 0	

# 0V to 16V, Dual Hot-Swap Controller with 10-Bit Current and Voltage Monitor and 4 LED Drivers

**Table 14. ADC Minimum Current Conversion Register Format (Low-Order Bits)**

Description:		Minimum current conversion result low-order bits [1:0]							
Register Title:		min_ch0_cs_lsb		min_ch1_cs_lsb					
Register Addresses:		0x09		0x11					
R	R	R	R	R	R	R	R	RESET VALUE	
						imin_1	imin_0	0x03	
bit 7	bit 6	bit 5	bit 4	bit 3	bit 2	bit 1	bit 0		

**Table 15. ADC Maximum Current Conversion Register Format (High-Order Bits)**

Description:		Maximum current conversion result high-order bits [9:2]							
Register Title:		max_ch0_cs_msb		max_ch1_cs_msb					
Register Addresses:		0x0A		0x12					
R	R	R	R	R	R	R	R	RESET VALUE	
imax_9	imax_8	imax_7	imax_6	imax_5	imax_4	imax_3	imax_2	0x00	
bit 7	bit 6	bit 5	bit 4	bit 3	bit 2	bit 1	bit 0		

**Table 16. ADC Maximum Current Conversion Register Format (Low-Order Bits)**

Description:		Maximum current conversion result low-order bits [1:0]							
Register Title:		max_ch0_cs_lsb		max_ch1_cs_lsb					
Register Addresses:		0x0B		0x13					
R	R	R	R	R	R	R	R	RESET VALUE	
						imax_1	imax_0	0x00	
bit 7	bit 6	bit 5	bit 4	bit 3	bit 2	bit 1	bit 0		

# 0V to 16V, Dual Hot-Swap Controller with 10-Bit Current and Voltage Monitor and 4 LED Drivers

## Digital Voltage Monitoring and Power-Good Outputs

The voltage at the load (MON\_ inputs) is sampled by the internal ADC. The MON\_ full-scale voltage for each

channel can be set to 16V, 8V, 4V, or 2V by writing to register mon\_range. The default range is 16V (Tables 17 and 18).

**Table 17. ADC Voltage Monitor Settings Register Format**

Description:		ADC voltage monitor full-scale range settings (for MON_ inputs)							
Register Title:		mon_range							
Register Addresses:		0x18							
R/W	R/W	R/W	R/W	R/W	R/W	R/W	R/W	RESET VALUE	
—	—	—	—	MON2_rng1	MON2_rng0	MON1_rng1	MON1_rng0	0x00	
bit 7	bit 6	bit 5	bit 4	bit 3	bit 2	bit 1	bit 0		

**Table 18. ADC Full-Scale Voltage Setting**

MONx_rng1	MONx_rng0	ADC FULL-SCALE VOLTAGE (V)
0	0	16
0	1	8
1	0	4
1	1	2

The most recent voltage conversion results can be read from the adc\_chx\_mon\_msb and adc\_chx\_mon\_lsb registers (see Tables 19 and 20).

**Table 19. ADC Voltage Conversion Result Register Format (High-Order Bits)**

Description:		Most recent voltage conversion result, high-order bits [9:2]							
Register Title:		adc_ch0_mon_msb		adc_ch1_mon_msb					
Register Addresses:		0x02		0x06					
R	R	R	R	R	R	R	R	RESET VALUE	
vnew_9	vnew_8	vnew_7	vnew_6	vnew_5	vnew_4	vnew_3	vnew_2	0x00	
bit 7	bit 6	bit 5	bit 4	bit 3	bit 2	bit 1	bit 0		

**Table 20. ADC Voltage Conversion Result Register Format (Low-Order Bits)**

Description:		Most recent voltage conversion result, low-order bits [1:0]							
Register Title:		adc_ch0_mon_lsb		adc_ch1_mon_lsb					
Register Addresses:		0x03		0x07					
R	R	R	R	R	R	R	R	RESET VALUE	
						vnew_1	vnew_0	0x00	
bit 7	bit 6	bit 5	bit 4	bit 3	bit 2	bit 1	bit 0		

# 0V to 16V, Dual Hot-Swap Controller with 10-Bit Current and Voltage Monitor and 4 LED Drivers

## Digital Undervoltage and Overvoltage Detection Thresholds

The most recent voltage values are continuously compared to four programmable limits, comprising two

undervoltage (UV) levels (see Tables 21–24) and two overvoltage (OV) levels (see Tables 25–28).

**Table 21. Undervoltage Warning Threshold Register Format (High-Order Bits)**

Description:		Undervoltage warning threshold high-order bits [9:2]							
Register Title:		uv1th_ch0_msb	uv1th_ch1_msb						
Register Addresses:		0xA1	0x1E						
R/W	R/W	R/W	R/W	R/W	R/W	R/W	R/W	RESET VALUE	
uv1_9	uv1_8	uv1_7	uv1_6	uv1_5	uv1_4	uv1_3	uv1_2	0x00	
bit 7	bit 6	bit 5	bit 4	bit 3	bit 2	bit 1	bit 0		

**Table 22. Undervoltage Warning Threshold Register Format (Low-Order Bits)**

Description:		Undervoltage warning threshold low-order bits [1:0]							
Register Titles:		uv1th_ch0_lsb	uv1th_ch1_lsb						
Register Addresses:		0x1B	0x1F						
R	R	R	R	R	R	R/W	R/W	RESET VALUE	
						uv1_1	uv1_0	0x00	
bit 7	bit 6	bit 5	bit 4	bit 3	bit 2	bit 1	bit 0		

**Table 23. Undervoltage Critical Threshold Register Format (High-Order Bits)**

Description:		Undervoltage critical threshold high-order bits [9:2]							
Register Title:		uv2th_ch0_msb	uv2th_ch1_msb						
Register Addresses:		0x1C	0x26						
R/W	R/W	R/W	R/W	R/W	R/W	R/W	R/W	RESET VALUE	
uv2_9	uv2_8	uv2_7	uv2_6	uv2_5	uv2_4	uv2_3	uv2_2	0x00	
bit 7	bit 6	bit 5	bit 4	bit 3	bit 2	bit 1	bit 0		

**Table 24. Undervoltage Critical Threshold Register Format (Low-Order Bits)**

Description:		Undervoltage critical threshold low-order bits [1:0]							
Register Title:		uv2th_ch0_lsb	uv2th_ch1_lsb						
Register Addresses:		0x1D	0x27						
R	R	R	R	R	R	R/W	R/W	RESET VALUE	
						uv2_1	uv2_0	0x00	
bit 7	bit 6	bit 5	bit 4	bit 3	bit 2	bit 1	bit 0		

# 0V to 16V, Dual Hot-Swap Controller with 10-Bit Current and Voltage Monitor and 4 LED Drivers

**Table 25. Overvoltage Warning Threshold Register Format (High-Order Bits)**

Description:		Overvoltage warning threshold high-order bits [9:2]							
Register Title:		ov1thr_ch0_msb		ov1thr_ch1_msb					
Register Addresses:		0x1E		0x28					
R/W	R/W	R/W	R/W	R/W	R/W	R/W	R/W	RESET VALUE	
ov1_9	ov1_8	ov1_7	ov1_6	ov1_5	ov1_4	ov1_3	ov1_2	0xFF	
bit 7	bit 6	bit 5	bit 4	bit 3	bit 2	bit 1	bit 0		

**Table 26. Overvoltage Warning Threshold Register Format (Low-Order Bits)**

Description:		Overvoltage warning threshold low-order bits [1:0]							
Register Title:		ov1thr_ch0_lsb		ov1thr_ch1_lsb					
Register Addresses:		0x1F		0x29					
R	R	R	R	R	R	R/W	R/W	RESET VALUE	
						ov1_1	ov1_0	0x03	
bit 7	bit 6	bit 5	bit 4	bit 3	bit 2	bit 1	bit 0		

**Table 27. Overvoltage Critical Threshold Register Format (High-Order Bits)**

Description:		Overvoltage critical threshold high-order bits [9:2]							
Register Title:		ov2thr_ch0_msb		ov2thr_ch1_msb					
Register Addresses:		0x20		0x2A					
R/W	R/W	R/W	R/W	R/W	R/W	R/W	R/W	RESET VALUE	
ov2_9	ov2_8	ov2_7	ov2_6	ov2_5	ov2_4	ov2_3	ov2_2	0xFF	
bit 7	bit 6	bit 5	bit 4	bit 3	bit 2	bit 1	bit 0		

**Table 28. Overvoltage Critical Threshold Register Format (Low-Order Bits)**

Description:		Overvoltage critical threshold low-order bits [1:0]							
Register Title:		ov2thr_ch0_lsb		ov2thr_ch1_lsb					
Register Addresses:		0x21		0x2B					
R	R	R	R	R	R	R/W	R/W	RESET VALUE	
						ov2_1	ov2_0	0x03	
bit 7	bit 6	bit 5	bit 4	bit 3	bit 2	bit 1	bit 0		

# 0V to 16V, Dual Hot-Swap Controller with 10-Bit Current and Voltage Monitor and 4 LED Drivers

If PG\_ is asserted and the voltage is outside the warning limits, the  $\overline{\text{ALERT}}$  output is asserted low. Depending on the status of the prot[] bits in register status1[7:6], the MAX5970 can also deassert the PG\_ output or turn off the external MOSFET when the voltage is outside the critical limits (see Figure 3). Table 29 shows the behavior for the three possible states of the PROT input. Note that the PROT input does not affect the MAX5970 response to the UV or OV warning digital comparators; it only determines

the system response to the critical digital comparators (see Tables 4a, 4b, and 29).

In a typical application, the UV1 and OV1 thresholds would be set closer to the nominal output voltage, and the UV2 and OV2 thresholds would be set further from nominal. This provides a progressive response to a voltage excursion. However, the thresholds can be configured in any arrangement or combination as desired to suit a given application.

**Table 29. PROT Input and prot[] Bits**

PROT INPUT STATE	prot[1]	prot[0]	UV/OV WARNING ACTION	UV/OV CRITICAL ACTION
Low	0	0	Assert $\overline{\text{ALERT}}$	Assert $\overline{\text{ALERT}}$ , clear PG_, shutdown channel(s)
High	0	1	Assert $\overline{\text{ALERT}}$	Assert $\overline{\text{ALERT}}$ , clear PG_
Unconnected	1	0	Assert $\overline{\text{ALERT}}$	Assert $\overline{\text{ALERT}}$

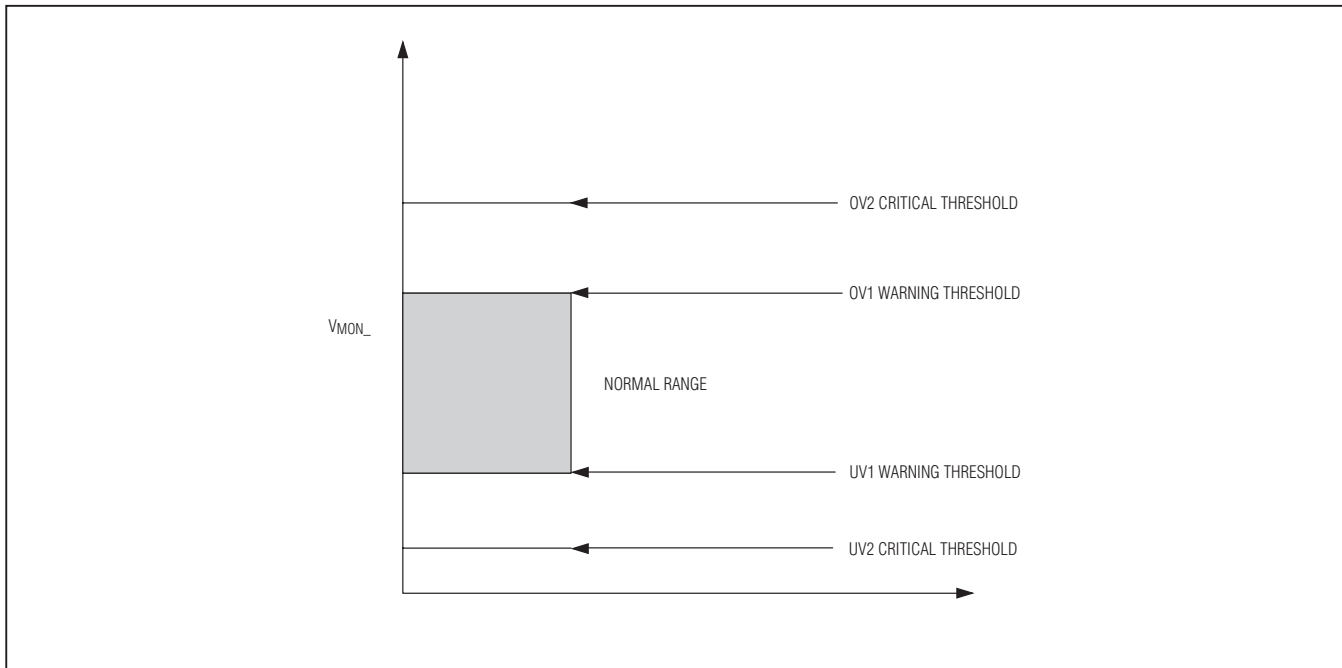

Figure 3. Graphical Representation of Typical UV and OV Thresholds Configuration

# 0V to 16V, Dual Hot-Swap Controller with 10-Bit Current and Voltage Monitor and 4 LED Drivers

## Power-Good Detection and PG\_ Outputs

The PG\_ output for a given channel is asserted when the voltage at MON\_ is between the undervoltage and overvoltage critical limits. The status of the power-good signals is maintained in register status3[3:0]. A value of

1 in any of the pg[] bits indicates a power-good condition, regardless of the POL setting, which only affects the PG\_ output polarity. The open-drain PG\_ output can be configured for active-high or active-low status indication by the state of the POL input (see Table 30).

**Table 30. status3 Register Format**

Description:		Power-good status register; LATCH, POL, ALERT and Power Good bits							
Register Title:		status3							
Register Address:		0x34							
R	R	R	R/W	R	R	R	R	RESET VALUE	
—	RETRY	POL	ALERT			pg[1]	pg[0]	0x00	
bit 7	bit 6	bit 5	bit 4	bit 3	bit 2	bit 1	bit 0		

The POL input sets the value of *status3[5]*, which is a read-only bit; the state of the POL input can be changed at any time during operation and the polarity of the PG\_ outputs changes accordingly.

The assertion of the PG\_ output is delayed by a user-selectable time delay of 50ms, 100ms, 200ms, or 400ms (see Tables 31a and 31b).

**Table 31a. Power-Good Assertion Delay-Time Register Format**

Description:		Power-good assertion delay-time register							
Register Title:		pgdly							
Register Address:		0x38							
R	R	R	R	R/W	R/W	R/W	R/W	RESET VALUE	
—	—	—	—	pgdly1 (CH1)	pgdly0 (CH1)	pgdly1 (CH0)	pgdly0 (CH0)	0x00	
bit 7	bit 6	bit 5	bit 4	bit 3	bit 2	bit 1	bit 0		

**Table 31b. Power-Good Assertion Delay**

pgdly1 (CH_)	pgdly0 (CH_)	PG_ ASSERTION DELAY (ms)
0	0	50
0	1	100
1	0	200
1	1	400

# 0V to 16V, Dual Hot-Swap Controller with 10-Bit Current and Voltage Monitor and 4 LED Drivers

## Minimum and Maximum Value Detection for Voltage Measurement Values

All voltage measurement values are compared with the contents of minimum- and maximum-value registers, and if the most recent measurement exceeds the stored maximum or is less than the stored minimum, the corresponding register is updated with the new value. These

peak detection registers are read accessible through the I<sup>2</sup>C interface (see Tables 32–35). The minimum-value registers are reset to 0x3FF, and the maximum-value registers are reset to 0x000. These reset values are loaded upon startup of a channel or at any time as commanded by register `peak_log_rst` (see Table 36).

**Table 32. ADC Minimum Voltage Conversion Register Format (High-Order Bits)**

Description:		Minimum voltage conversion result, high-order bits [9:2]							
Register Title:		min_ch0_mon_msb		min_ch1_mon_msb					
Register Addresses:		0x0C		0x14					
R/W	R/W	R/W	R/W	R/W	R/W	R/W	R/W	RESET VALUE	
vmin_9	vmin_8	vmin_7	vmin_6	vmin_5	vmin_4	vmin_3	vmin_2	0xFF	
bit 7	bit 6	bit 5	bit 4	bit 3	bit 2	bit 1	bit 0		

**Table 33. ADC Minimum Voltage Conversion Register Format (Low-Order Bits)**

Description:		Minimum voltage conversion result, low-order bits [1:0]							
Register Title:		min_ch0_mon_lsb		min_ch1_mon_lsb					
Register Addresses:		0x0D		0x15					
R/W	R/W	R/W	R/W	R/W	R/W	R/W	R/W	RESET VALUE	
						vmin_1	vmin_0	0x03	
bit 7	bit 6	bit 5	bit 4	bit 3	bit 2	bit 1	bit 0		

**Table 34. ADC Maximum Voltage Conversion Register Format (High-Order Bits)**

Description:		Maximum voltage conversion result, high-order bits [9:2]							
Register Title:		max_ch0_mon_msb		max_ch1_mon_msb					
Register Addresses:		0x0E		0x12					
R	R	R	R	R	R	R/W	R/W	RESET VALUE	
vmax_9	vmax_8	vmax_7	vmax_6	vmax_5	vmax_4	vmax_3	vmax_2	0x00	
bit 7	bit 6	bit 5	bit 4	bit 3	bit 2	bit 1	bit 0		

# 0V to 16V, Dual Hot-Swap Controller with 10-Bit Current and Voltage Monitor and 4 LED Drivers

**Table 35. ADC Maximum Voltage Conversion Register Format (Low-Order Bits)**

Description:		Maximum voltage conversion result, low-order bits [1:0]								
Register Title:		max_ch0_mon_lsb		max_ch1_mon_lsb						
Register Addresses:		0x0F		0x13						
R	R	R	R	R	R	R/W	R/W	RESET VALUE		
						vmax_1	vmax_0	0x00		
bit 7	bit 6	bit 5	bit 4	bit 3	bit 2	bit 1	bit 0			

### Using the Voltage and Current Peak-Detection Registers

The voltage and current minimum- and maximum-value records in register locations 0x08 through 0x17 can be reset by writing a 1 to the appropriate location in register peak\_log\_rst (see Table 36). The minimum-value registers are reset to 0x3FF, and the maximum-value registers are reset to 0x00.

As long as a bit in peak\_log\_rst is 1, the corresponding peak-detection registers are disabled and are cleared to their power-up reset values. The voltage and current

minimum- and maximum-detection register contents for each signal can be held by setting bits in register peak\_log\_hold (see Table 37). Writing a 1 to a location in peak\_log\_hold locks the register contents for the corresponding signal and stops the min/max detection and logging; writing a 0 enables the detection and logging. Note that the peak-detection registers cannot be cleared while they are held by register peak\_log\_hold.

The combination of these two control registers allows the user to monitor voltage and current peak-to-peak values during a particular time period.

**Table 36. Peak-Detection Reset-Control Register Format**

Description:		Reset control bits for peak-detection registers								
Register Title:		peak_log_rst								
Register Address:		0x41								
R	R	R	R	R/W	R/W	R/W	R/W	RESET VALUE		
—	—	—	—	Ch1_v_rst	Ch1_i_rst	Ch0_v_rst	Ch0_i_rst	0x00		
bit 7	bit 6	bit 5	bit 4	bit 3	bit 2	bit 1	bit 0			

**Table 37. Peak-Detection Hold-Control Register Format**

Description:		Hold control bits for peak-detection registers; per signal								
Register Title:		peak_log_hold								
Register Address:		0x42								
R	R	R	R	R/W	R/W	R/W	R/W	RESET VALUE		
—	—	—	—	Ch1_v_hld	Ch1_i_hld	Ch0_v_hld	Ch0_i_hld	0x00		
bit 7	bit 6	bit 5	bit 4	bit 3	bit 2	bit 1	bit 0			

# 0V to 16V, Dual Hot-Swap Controller with 10-Bit Current and Voltage Monitor and 4 LED Drivers

## Deglitching of Digital Comparators

The five digital comparators per hot-swap channel (undervoltage/overvoltage warning and critical, over-current warning) all have a user-selectable deglitching feature that requires two consecutive positive compares before the MAX5970 takes action as determined by the particular compare and the setting of the PROT input.

The deglitching function is enabled or disabled per comparator by registers `dgl_i`, `dgl_uv`, and `dgl_ov` (Tables 38, 39, and 40). Writing a 1 to the appropriate bit location in these registers enables the deglitch function for the corresponding digital comparator.

**Table 38. OI Warning Comparators Deglitch Enable Register Format**

Description:		Deglitch enable register for overcurrent warning digital comparators						
Register Title:		dgl_i						
Register Address:		0x3C						
R	R	R	R	R	R	R/W	R/W	RESET VALUE
—	—	—	—	—	—	Ch1_dgl_i	Ch0_dgl_i	0x00
bit 7	bit 6	bit 5	bit 4	bit 3	bit 2	bit 1	bit 0	

**Table 39. UV Warning and Critical Comparators Deglitch Enable Register Format**

Description:		Deglitch enable register for undervoltage warning and critical digital comparators						
Register Title:		dgl_uv						
Register Address:		0x3D						
R	R	R	R	R/W	R/W	R/W	R/W	RESET VALUE
—	—	—	—	Ch1_dgl_uv2	Ch1_dgl_uv1	Ch0_dgl_uv2	Ch0_dgl_uv1	0x00
bit 7	bit 6	bit 5	bit 4	bit 3	bit 2	bit 1	bit 0	

**Table 40. OV Warning and Critical Comparators Deglitch Enable Register Format**

Description:		Deglitch enable register for overvoltage warning and critical digital comparators						
Register Title:		dgl_ov						
Register Address:		0x3E						
R	R	R	R	R/W	R/W	R/W	R/W	RESET VALUE
—	—	—	—	Ch1_dgl_ov2	Ch1_dgl_ov1	Ch0_dgl_ov2	Ch0_dgl_ov1	0x00
bit 7	bit 6	bit 5	bit 4	bit 3	bit 2	bit 1	bit 0	

# 0V to 16V, Dual Hot-Swap Controller with 10-Bit Current and Voltage Monitor and 4 LED Drivers

## Circular Buffer

The MAX5970 features four 10-bit “circular buffers” (in volatile memory) that contain a history of the 50 most-recent voltage and current digital conversion results for each hot-swap channel. These circular buffers can be read back through the I<sup>2</sup>C interface. The recording of new data to the buffer for a given signal is stopped under any of the following conditions:

- The corresponding channel is shut down because of a fault condition.

- Clearing appropriate bits in register `cbuf_chx_store`.
- A read of the circular buffer base address is performed through the I<sup>2</sup>C interface.
- The corresponding channel is turned off by a combination of the `Chx_EN1`, `Chx_EN2`, or `ON_` signals.

The buffers allow the user to recall the voltage and current waveforms for analysis and troubleshooting. The buffer contents are accessed through the I<sup>2</sup>C interface at **four** fixed addresses in the MAX5970 register address space (see Table 41).

**Table 41. Circular Buffer Read Addresses**

ADDRESS	NAME	DESCRIPTION
0x46	<code>cbuf_ba_ch0_v</code>	Base address for channel 0 voltage buffer block read
0x47	<code>cbuf_ba_ch0_i</code>	Base address for channel 0 current buffer block read
0x48	<code>cbuf_ba_ch1_v</code>	Base address for channel 1 voltage buffer block read
0x49	<code>cbuf_ba_ch1_i</code>	Base address for channel 1 current buffer block read

Each of the four buffers can also be stopped under user control by register `cbuf_chx_store` (see Table 42).

**Table 42. Circular Buffer Control Register Format**

Description:		Circular buffer run-stop control register (per-buffer control: 1 = run, 0 = stop)						RESET VALUE
Register Title:		<code>cbuf_chx_store</code>						
Register Address:		0x19						
R	R	R	R	R/W	R/W	R/W	R/W	
—	—	—	—	Ch1_i_run	Ch1_v_run	Ch0_i_run	Ch0_v_run	0x0F
bit 7	bit 6	bit 5	bit 4	bit 3	bit 2	bit 1	bit 0	

The contents of a buffer can be retrieved as a block read of either fifty 10-bit values (spanning 2 bytes each) or of

fifty high-order bytes, depending on the per-signal bit settings of register `cbufrd_hibyonly` (see Table 43).

**Table 43. Circular Buffer Resolution Register Format**

Description:		Circular buffer read-out resolution: high-order byte only, or 8-2 split 10-bit data (per-buffer control: 1 = high-order byte output, 0 = full-resolution 10-bit output)						RESET VALUE
Register Title:		<code>cbufrd_hibyonly</code>						
Register Address:		0x3F						
R	R	R	R	R/W	R/W	R/W	R/W	
—	—	—	—	Ch1_i_res	Ch1_v_res	Ch0_i_res	Ch0_v_res	0x0F
bit 7	bit 6	bit 5	bit 4	bit 3	bit 2	bit 1	bit 0	

# 0V to 16V, Dual Hot-Swap Controller with 10-Bit Current and Voltage Monitor and 4 LED Drivers

If the circular buffer contents are retrieved as 10-bit data, the first byte read out is the high-order 8 bits of the 10-bit sample, and the second byte read out contains the two least-significant bits (LSBs) of the sample. This is repeated for each of the 50 samples in the buffer. Thus, 2 bytes must be read for each 10-bit sample retrieved. Conversely, if the buffer contents are retrieved as 8-bit data, then each byte read out contains the 8 MSB of each successive sample. It is important to remember

that in 10-bit mode, 100 bytes must be read to extract the entire buffer contents, but in 8-bit mode, only 50 bytes must be read.

The circular buffer system has a user-programmable stop delay that specifies a certain number of sample cycles to continue recording to the buffer after a shutdown occurs. This delay value is stored in register `cbuf_dly_stop[5:0]` (see Table 44).

**Table 44. Circular Buffer Stop-Delay Register Format**

Description:		Circular buffer stop-delay: any integer number between 0 and 50 samples that are to be recorded to a buffer after a shutdown event, before the buffer stops storing new data.						
Register Title:		<code>cbuf_dly_stop</code>						
Register Address:		0x40						
R	R	R	R	R	R	R	R	RESET VALUE
0	0							0x19
bit 7	bit 6	bit 5	bit 4	bit 3	bit 2	bit 1	bit 0	

The default (reset) value of the buffer stop-delay is 25 samples, which means that an equal number of samples are stored in the buffer preceding and following the moment of the shutdown event. The buffer stop delay is analogous to an oscilloscope trigger delay, because it allows the MAX5970 to record what happened both immediately before and after a shutdown. In other words, when the contents of a circular buffer are read out of the MAX5970, the shutdown event, by default, is located in the middle of the recorded data. The balance of data before and after an event can be altered by writing a different value (between 0 and 50) to the buffer stop-delay register.

**Autoretry or Latched-Off Fault Management**

In the event of an overcurrent, undervoltage, or overvoltage condition that results in the shutdown of one or both channels, the MAX5970 device can be configured to either latch off or automatically restart the affected channel. The MAX5970 stays off if the RETRY input is set low

(latched-off), and automatically retries if the RETRY input is high. The RETRY input is read once during initialization and sets the value of `status3[6]` register (see Table 30).

The autoretry feature has a fixed 200ms timeout delay between fault shutdown and the autorestart attempt. Be aware that if the MAX5970 is configured for autoretry operation, the startup event occurs every 200ms if a short circuit occurs. A short circuit during startup causes the output current to increase rapidly as the MOSFET is enhanced, until the slow-trip threshold is reached and the gate is pulled low again. Be sure to evaluate MOSFET junction temperature rise for this repeated-stress condition if autoretry is used.

To restart a channel that has been shutdown in latched-off operation (RETRY low), the user must either cycle power to the IN pin, or toggle one or more of the ON\_ pin, `Chx_EN1` bit, or the `Chx_EN2` bit for the affected channel.

# 0V to 16V, Dual Hot-Swap Controller with 10-Bit Current and Voltage Monitor and 4 LED Drivers

## Force-On Function

When the force-on bit for a channel is set to 1 in register fose[1:0] (see Table 45), the channel is enabled regardless of the ON\_ voltage or the Chx\_EN1 and Chx\_EN2 bits in register chxen. In forced-on operation, all functions operate normally with the notable exception that the channel does not shut down due to any fault conditions that may arise.

There is a Force-On Key register fokey that must be set to 0xA5 in order for the Force-On function to become active (see Table 46). If this register contains any value other than 0xA5, writing 1 to the Force-On bits in register fose has no effect. This provides protection against accidental force-on operation that might otherwise be caused by an erroneous I<sup>2</sup>C write.

**Table 45. Force-On Control Register Format**

Description:		Force-on control register							
Register Title:		fose							
Register Address:		0x3A							
R	R	R	R	R	R	R/W	R/W	RESET VALUE	
0	0	0	0	0	0	Ch1_fo	Ch_fo	0x00	
bit 7	bit 6	bit 5	bit 4	bit 3	bit 2	bit 1	bit 0		

**Table 46. Force-On Key Register Format**

Description:		Force-on key register (must contain 0xA5 to unlock force-on feature)							
Register Title:		fokey							
Register Address:		0x39							
R/W	R/W	R/W	R/W	R/W	R/W	R/W	R/W	RESET VALUE	
fokey[7]	fokey[6]	fokey[5]	fokey[4]	fokey[3]	fokey[2]	fokey[1]	fokey[0]	0x00	
bit 7	bit 6	bit 5	bit 4	bit 3	bit 2	bit 1	bit 0		

## Fault Logging and Indications

The MAX5970 provides detailed information about any fault conditions that have occurred. Independent FAULT outputs specifically indicate circuit-breaker shutdown events, while an ALERT output is asserted whenever a problem has occurred that requires attention or interaction.

## Fault Dependency

If a fault event occurs (digital UV warning/critical, digital OV warning/critical, or digital overcurrent warning), the fault is logged by setting a corresponding bit in registers fault1 or fault2 (see Tables 47, 48, and 49).

**Table 47. Undervoltage Status Register Format**

Description:		Undervoltage digital-compare status register (warning [1:0] and critical [5:4] undervoltage event detection status)							
Register Title:		fault0							
Register Address:		0x35							
R	R	R/C	R/C	R	R	R/C	R/C	RESET VALUE	
—	—	ch1_uv2	Ch0_uv2	—	—	Ch1_uv1	Ch0_uv1	0x00	
bit 7	bit 6	bit 5	bit 4	bit 3	bit 2	bit 1	bit 0		

# 0V to 16V, Dual Hot-Swap Controller with 10-Bit Current and Voltage Monitor and 4 LED Drivers

**Table 48. Overvoltage Status Register Format**

Description:		Overvoltage digital-compare status register (warning [1:0] and critical [5:4] overvoltage event detection status)							
Register Title:		fault1							
Register Address:		0x36							
R	R	R/C	R/C	R	R	R/C	R/C	RESET VALUE	
—	—	Ch1_ov2	Ch0_ov2	—	—	Ch1_ov1	Ch0_ov1	0x00	
bit 7	bit 6	bit 5	bit 4	bit 3	bit 2	bit 1	bit 0		

**Table 49. Overcurrent Warning Status Register Format**

Description:		Overcurrent digital-compare status register (overcurrent warning event detection status)							
Register Title:		fault2							
Register Address:		0x37							
R	R	R	R	R	R	R/C	R/C	RESET VALUE	
						Ch1_oi	Ch0_oi	0x00	
bit 7	bit 6	bit 5	bit 4	bit 3	bit 2	bit 1	bit 0		

Likewise, circuit-breaker shutdown events are logged in register status0[7:0] (see Table 50).

**Table 50. Circuit-Breaker Event Logging Register Format**

Description:		Circuit-breaker slow- and fast-trip event logging							
Register Title:		status0							
Register Address:		0x31							
R	R	R	R	R	R	R	R	RESET VALUE	
—	—	IFAULTS1	IFAULTS0	—	—	IFAULTF1	IFAULTF0	—	
bit 7	bit 6	bit 5	bit 4	bit 3	bit 2	bit 1	bit 0		

# 0V to 16V, Dual Hot-Swap Controller with 10-Bit Current and Voltage Monitor and 4 LED Drivers

IFAULTSx indicates the overcurrent status from slow comparator. IFAULTFx indicates overcurrent status from fast comparator. The status of  $\overline{\text{FAULT}}$  reflects the NOR operation of IFAULTSx and IFAULTFx.

These fault register bits latch upon fault condition and are reset by restarting the affected channel as described in the *Autoretry or Latched-Off Fault Management* section.

### $\overline{\text{FAULT}}$ Outputs

When an overcurrent event (fast-trip or slow-trip) causes the MAX5970 to shut down the affected channel(s), a corresponding open-drain  $\overline{\text{FAULT}}$  output is asserted low. Note that the  $\overline{\text{FAULT}}$  outputs are not asserted for shutdowns caused by critical under-voltage or overvoltage.

The  $\overline{\text{FAULT}}$  output is cleared when the channel is disabled by pulling ON<sub>n</sub> low or by clearing the bits in the chxen register.

### $\overline{\text{ALERT}}$ Output

$\overline{\text{ALERT}}$  is an open-drain output that is asserted low any time that a fault or other condition requiring attention has occurred. The state of the  $\overline{\text{ALERT}}$  output is also indicated by status3[4].

$\overline{\text{ALERT}}$  is the NOR of registers 0x31, 0x35, 0x36 and 0x37, so when the  $\overline{\text{ALERT}}$  output goes low, the system microcontroller should query these registers through the I<sup>2</sup>C interface to determine the cause of the  $\overline{\text{ALERT}}$  assertion.

### LED Set Registers

The MAX5970 has four open-drain LED drivers/user-programmable GPIOs. When programmed as LED drivers, each driver can sink up to 25mA of current. Table 51 shows the register that enables the drivers as either LED drivers or GPIOs.

When any of the LED\_Set bit in the register is set to 1, the corresponding open-drain LED driver is turned OFF. The LED\_Flash bits enable each corresponding LED driver to flash on and off at 1Hz frequency regardless of the condition of the corresponding LED\_Set bit.

Bits 7-4 in Table 52 show how to set the LED drivers to be either in phase or out of phase with the internal 1Hz clock. Bits 3-0 show how to enable the 4μA pullup current to disable a corresponding LED driver.

**Table 51. LED\_Flash/GPIO Enable Register**

Description:		LED_Flash/GPIO Enable register							
Register Title:		LED_flash							
Register Address:		0x43							
R/W	R/W	R/W	R/W	R/W	R/W	R/W	R/W	RESET VALUE	
LED4 Flash	LED3 Flash	LED2 Flash	LED1 Flash	LED4 Set	LED3 Set	LED2 Set	LED1 Set	0x0F	
bit 7	bit 6	bit 5	bit 4	bit 3	bit 2	bit 1	bit 0		

**Table 52. LED Phase/Weak Pullup Enable Register**

Description:		LED Phase/Weak Pullup Enable register							
Register Title:		LED_ph_pu							
Register Address:		0x44							
R/W	R/W	R/W	R/W	R/W	R/W	R/W	R/W	RESET VALUE	
LED4 Phase	LED3 Phase	LED2 Phase	LED1 Phase	LED4 Weak PU	LED3 Weak PU	LED2 Weak PU	LED1 Weak PU	0x00	
bit 7	bit 6	bit 5	bit 4	bit 3	bit 2	bit 1	bit 0		

# 0V to 16V, Dual Hot-Swap Controller with 10-Bit Current and Voltage Monitor and 4 LED Drivers

Table 53 shows LED State register. The LED State register is a read-only register. When the LEDs are disabled, the pins are configured as GPIOs. Applying an external voltage below 0.4V sets the GPIOs low and, applying an external voltage above 1.4V, sets the GPIOs high.

### I<sup>2</sup>C Serial Interface

The MAX5970 features an I<sup>2</sup>C serial interface consisting of a serial-data line (SDA) and a serial-clock line

(SCL). SDA and SCL allow bidirectional communication between the MAX5970 and the master device at clock rates from up to 400kHz. The I<sup>2</sup>C bus can have several devices (e.g., more than one MAX5970, or other I<sup>2</sup>C devices in addition to the MAX5970) attached simultaneously. The A0 and A1 inputs set one of nine possible I<sup>2</sup>C addresses (see Table 54).

**Table 53. LED State Register**

Description:		LED State register							
Register Title:		LED_State							
Register Address:		0x45							
R	R	R	R	R	R	R	R	R	RESET VALUE
—	—	—	—	LED4 Voltage	LED3 Voltage	LED2 Voltage	LED1 Voltage	—	—
bit 7	bit 6	bit 5	bit 4	bit 3	bit 2	bit 1	bit 0		

**Table 54. MAX5970 Slave Address Settings**

ADDRESS INPUT STATE		I <sup>2</sup> C ADDRESS BITS							
A1	A0	ADDR 7	ADDR 6	ADDR 5	ADDR 4	ADDR 3	ADDR 2	ADDR 1	ADDR 0
Low	Low	0	1	1	1	0	1	0	R/W
Low	High	0	1	1	1	0	0	1	R/W
Low	Open	0	1	1	1	0	0	0	R/W
High	Low	0	1	1	0	1	1	0	R/W
High	High	0	1	1	0	1	0	1	R/W
High	Open	0	1	1	0	1	0	0	R/W
Open	Low	0	1	1	0	0	1	0	R/W
Open	High	0	1	1	0	0	0	1	R/W
Open	Open	0	1	1	0	0	0	0	R/W

# 0V to 16V, Dual Hot-Swap Controller with 10-Bit Current and Voltage Monitor and 4 LED Drivers

The 2-wire communication is fully compatible with existing 2-wire serial interface systems; Figure 4 shows the interface timing diagram. The MAX5970 is a transmit/receive slave-only device, relying upon a master device to generate a clock signal. The master device (typically a microcontroller) initiates data transfer on the bus and generates SCL to permit that transfer.

A master device communicates to the MAX5970 by transmitting the proper address followed by command and/or data words. Each transmit sequence is framed by a START (S) or REPEATED START (Sr) condition and a STOP (P) condition. Each word transmitted over the bus

is 8 bits long and is always followed by an acknowledge pulse.

SCL is a logic input, while SDA is a logic input/open-drain output. SCL and SDA both require external pullup resistors to generate the logic-high voltage. Use 4.7kΩ for most applications.

### Bit Transfer

Each clock pulse transfers one data bit. The data on SDA must remain stable while SCL is high (see Figure 5), otherwise the MAX5970 registers a START or STOP condition (see Figure 6) from the master. SDA and SCL idle high when the bus is not busy.

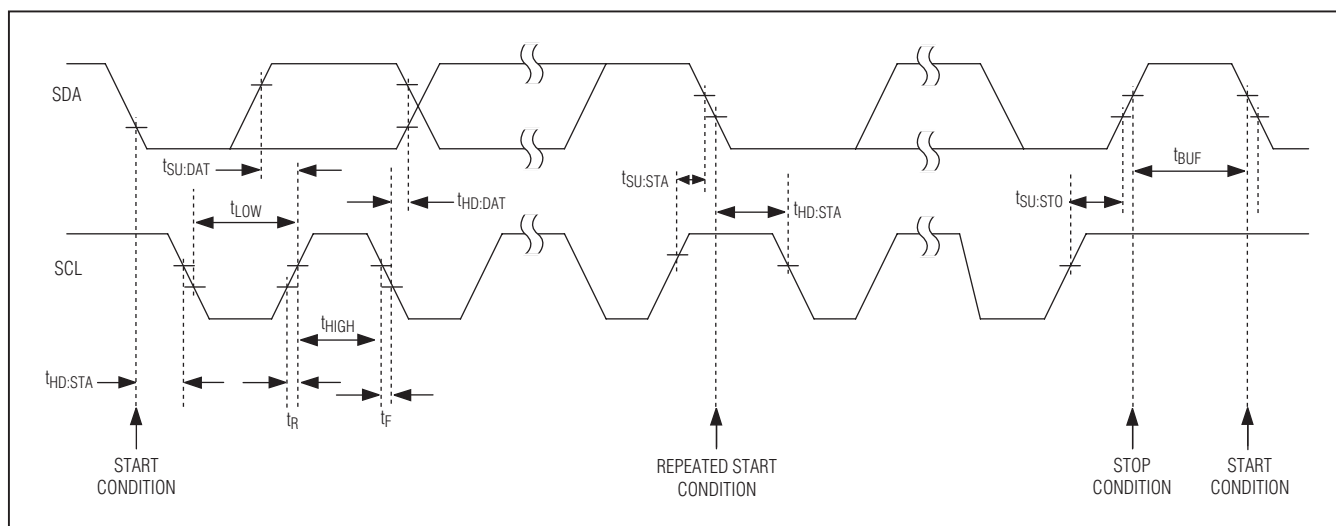

Figure 4. Serial-Interface Timing Details

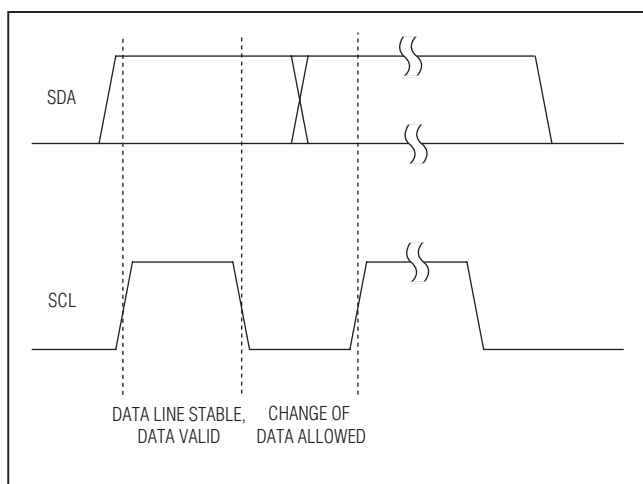

Figure 5. Bit Transfer

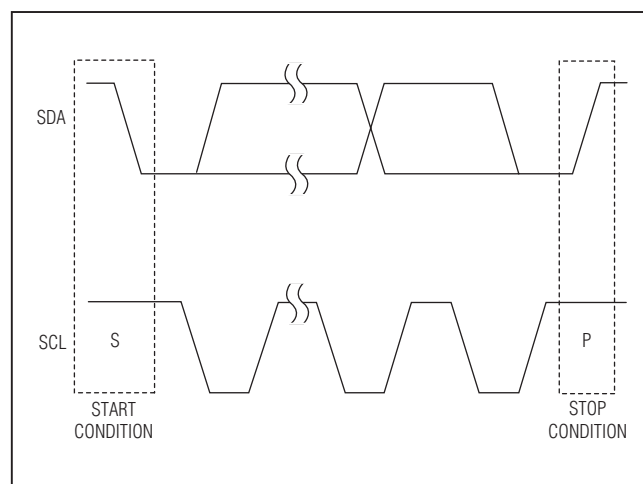

Figure 6. START and STOP Conditions

# 0V to 16V, Dual Hot-Swap Controller with 10-Bit Current and Voltage Monitor and 4 LED Drivers

## START and STOP Conditions

Both SCL and SDA idle high when the bus is not busy. A master device signals the beginning of a transmission with a START condition (see Figure 3) by transitioning SDA from high to low while SCL is high. The master

device issues a STOP condition (see Figure 6) by transitioning SDA from low to high while SCL is high. A STOP condition frees the bus for another transmission. The bus remains active if a REPEATED START condition is generated, such as in the block read protocol (see Figure 7).

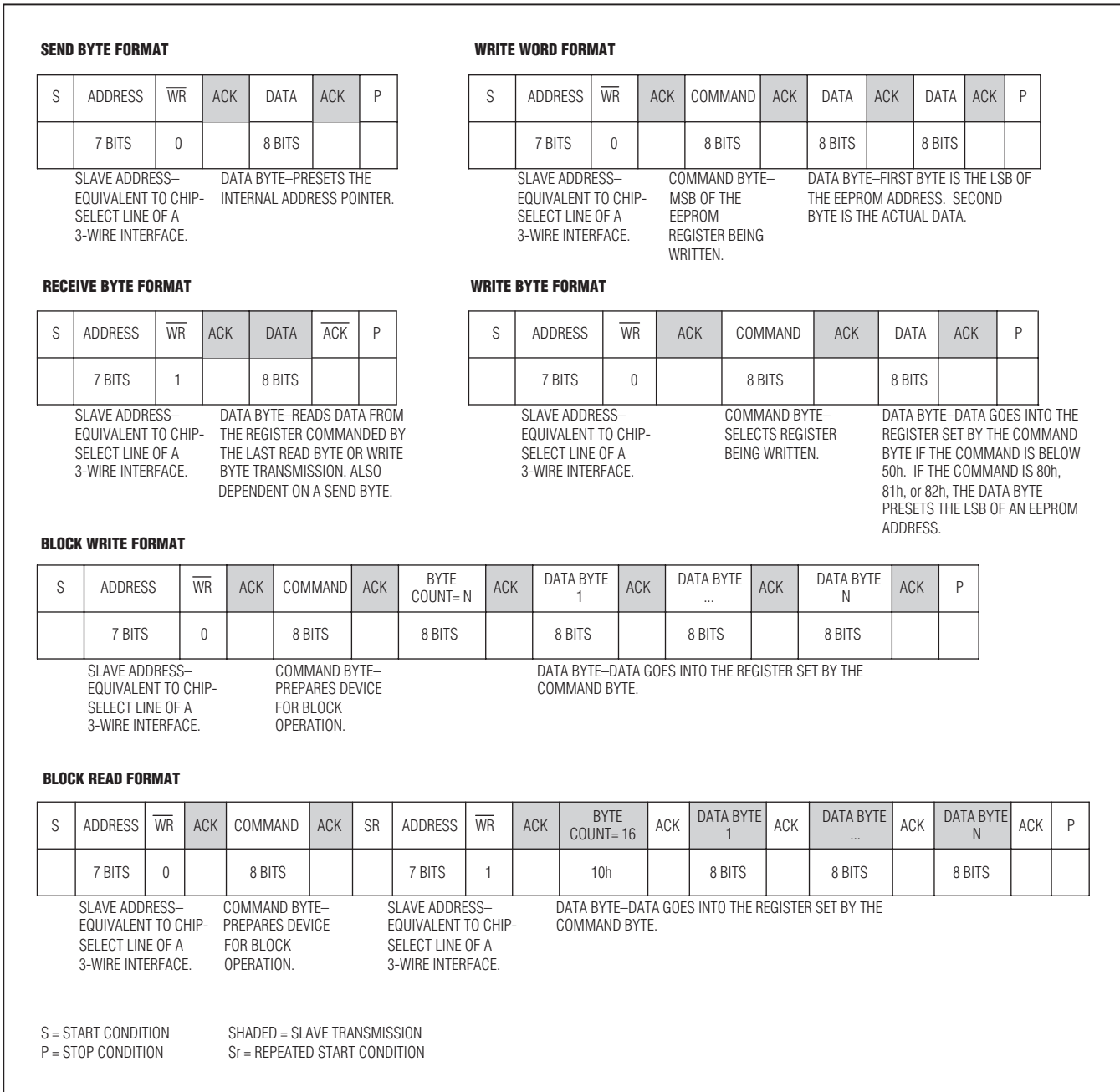

Figure 7. SMBUS/I<sup>2</sup>C Protocols

# 0V to 16V, Dual Hot-Swap Controller with 10-Bit Current and Voltage Monitor and 4 LED Drivers

## Early STOP Conditions

The MAX5970 recognizes a STOP condition at any point during transmission except if a STOP condition occurs in the same high pulse as a START condition. This condition is not a legal I<sup>2</sup>C format. At least one clock pulse must separate any START and STOP condition.

## REPEATED START Conditions

A REPEATED START (Sr) condition may indicate a change of data direction on the bus. Such a change occurs when a command word is required to initiate a read operation (see Figure 4). Sr may also be used when the bus master is writing to several I<sup>2</sup>C devices and does not want to relinquish control of the bus. The MAX5970 serial interface supports continuous write operations with or without an Sr condition separating them. Continuous read operations require Sr conditions because of the change in direction of data flow.

## Acknowledge

The acknowledge bit (ACK) is the 9th bit attached to any 8-bit data word. The receiving device always generates an ACK. The MAX5970 generates an ACK when receiving an address or data by pulling SDA low during the 9th clock period (see Figure 8). When transmitting data, such as when the master device reads data back from the MAX5970, the MAX5970 waits for the master device to generate an ACK. Monitoring ACK allows for detection of unsuccessful data transfers. An unsuccessful data transfer occurs if the receiving device is busy or if a system fault has occurred. In the event of an unsuccessful data transfer, the bus master should reattempt communication at a later time. The MAX5970 generates a NACK after the slave address during a software reboot or when receiving an illegal memory address.

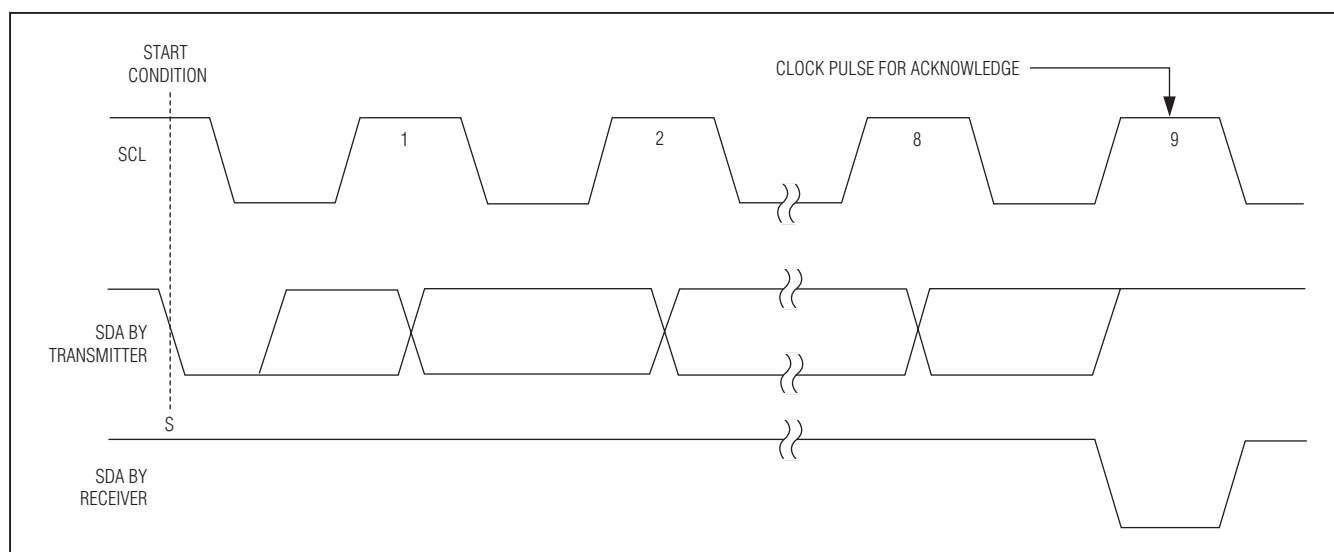

Figure 8. Acknowledge

# 0V to 16V, Dual Hot-Swap Controller with 10-Bit Current and Voltage Monitor and 4 LED Drivers

## Send Byte

The send byte protocol allows the master device to send one byte of data to the slave device (see Figure 9). The send byte presets a register pointer address for a subsequent read or write. The slave sends a NACK instead of an ACK if the master tries to send an address that is not allowed. If the master sends a STOP condition, the internal address pointer does not change. The send byte procedure follows:

- 1) The master sends a START condition.
- 2) The master sends the 7-bit slave address and a write bit (low).
- 3) The addressed slave asserts an ACK on SDA.
- 4) The master sends an 8-bit data byte.
- 5) The addressed slave asserts an ACK on SDA.
- 6) The master sends a STOP condition.

## Write Byte

The write byte/word protocol allows the master device to write a single byte in the register bank or to write to a series of sequential register addresses. The write byte procedure follows:

- 1) The master sends a START condition.
- 2) The master sends the 7-bit slave address and a write bit (low).
- 3) The addressed slave asserts an ACK on SDA.
- 4) The master sends an 8-bit command code.
- 5) The addressed slave asserts an ACK on SDA.
- 6) The master sends an 8-bit data byte.
- 7) The addressed slave asserts an ACK on SDA.
- 8) The addressed slave increments its internal address pointer.
- 9) The master sends a STOP condition or repeats steps 6, 7, and 8.

To write a single byte to the register bank, only the 8-bit command code and a single 8-bit data byte are sent. The data byte is written to the register bank if the command code is valid.

The slave generates a NACK at step 5 if the command code is invalid. The command code must be in the range of 0x00 to **0x45**. The internal address pointer returns to 0x00 after incrementing from the highest register address.

## Receive Byte

The receive byte protocol allows the master device to read the register content of the MAX5970 (see Figure 9). The EEPROM or register address must be preset with a send byte protocol first. Once the read is complete, the internal pointer increases by one. Repeating the receive byte protocol reads the contents of the next address. The receive byte procedure follows:

- 1) The master sends a START condition.
- 2) The master sends the 7-bit slave address and a read bit (high).
- 3) The addressed slave asserts an ACK on SDA.
- 4) The slave sends 8 data bits.
- 5) The slave increments its internal address pointer.
- 6) The master asserts an ACK on SDA and repeats steps 4 and 5 or asserts a NACK and generates a STOP condition.

The internal address pointer returns to 0x00 after incrementing from the highest register address.

# 0V to 16V, Dual Hot-Swap Controller with 10-Bit Current and Voltage Monitor and 4 LED Drivers

## Address Pointers

Use the send byte protocol to set the register address pointers before read and write operations. For the configuration registers, valid address pointers range from 0x00 to 0x45, and the circular buffer addresses are 0x46 to 0x49. Register addresses outside of this range result in a NACK being issued from the MAX5970.

## Circular Buffer Read

The circular buffer read operation is similar to the receive byte operation. The read operation is triggered after any one of the circular buffer base addresses is loaded. During a circular buffer read, although all is transparent from the external world, internally the auto increment function in the I<sup>2</sup>C controller is disabled. Thus, it is possible to read one of the circular buffer blocks with a burst read without changing the virtual internal address corresponding to the base address. Once the master issues

a NACK, the circular reading stops, and the default functions of I<sup>2</sup>C slave bus controller are restored. In 8-bit read mode, every I<sup>2</sup>C read operation shifts out a single sample from the circular buffer. In 10-bit mode, two subsequent I<sup>2</sup>C read operations shift out a single 10-bit sample from the circular buffer, with the high-order byte read first, followed by a byte containing the right-shifted two least-significant bits. Once the master issues a NACK, the read circular buffer operation terminates and normal I<sup>2</sup>C operation returns.

The data in the circular buffers is read back with the next-to-oldest sample first, followed by progressively more recent samples until the most recent sample is retrieved, followed finally by the oldest sample (see Table 55).

**Table 55. Circular Buffer Readout Sequence**

READ-OUT ORDER	1ST OUT	2ND OUT	...	48TH OUT	49TH OUT	50TH OUT
Chronological Number	1	2	...	48	49	0

## Chip Information

PROCESS: BiCMOS

## Package Information

For the latest package outline information and land patterns, go to [www.maxim-ic.com/packages](http://www.maxim-ic.com/packages). Note that a "+", "#", or "-" in the package code indicates RoHS status only. Package drawings may show a different suffix character, but the drawing pertains to the package regardless of RoHS status.

PACKAGE TYPE	PACKAGE CODE	DOCUMENT NO.
36 TQFN-EP	T3666-3	<a href="#">21-0114</a>

Maxim cannot assume responsibility for use of any circuitry other than circuitry entirely embodied in a Maxim product. No circuit patent licenses are implied. Maxim reserves the right to change the circuitry and specifications without notice at any time.

**Maxim Integrated Products, 120 San Gabriel Drive, Sunnyvale, CA 94086 408-737-7600** \_\_\_\_\_ 41







## Looking for pricing, stock, or lifecycle information?

Click below to explore more details on WIN SOURCE:

 [View MAX5970ETX+ on WIN SOURCE](#)

 [Maxim Integrated](#) Information

## Optimize Your Supply Chain with WIN SOURCE Solutions

-  Global Sourcing Solution
-  Obsolete Management
-  Cost Control Management
-  Shortage Management
-  Alternative Solution
-  Excess Inventory Management