



**THE DATASHEET OF
MAX20331EWL+**



MAX20331

High-Voltage Protection 3.5mm Audio Line OVP

General Description

The MAX20331/MAX20331A are overvoltage ICs designed to protect the audio codecs and electronics of portable devices. Connecting the MAX20331/MAX20331A between the 3.5mm jack and audio path electronics provides protection against high-voltage conditions to $\pm 40V$.

The MAX20331/MAX20331A are available in a space-saving, 9-bump, 0.4mm pitch, 1.23mm x 1.23mm wafer-level package (WLP) and operate over the $-40^{\circ}C$ to $+85^{\circ}C$ extended temperature range.

Applications

- Smartphones
- Tablets

Benefits and Features

- Protects Devices from High-Voltage Conditions
 - $\pm 40V$ Tolerant Inputs
- Multiple OVP Thresholds for Flexible Design
 - $\pm 3.45V$ MAX20331, $\pm 5.5V$ MAX20331A
- Low THD+N Preserves Audio Clarity
- Saves Board Space with Small Form Factor
 - 1.23mm x 1.23mm, 3 x 3 Array, 9-Bump, 0.4mm Pitch WLP

Ordering Information appears at end of data sheet.

Typical Application Circuit

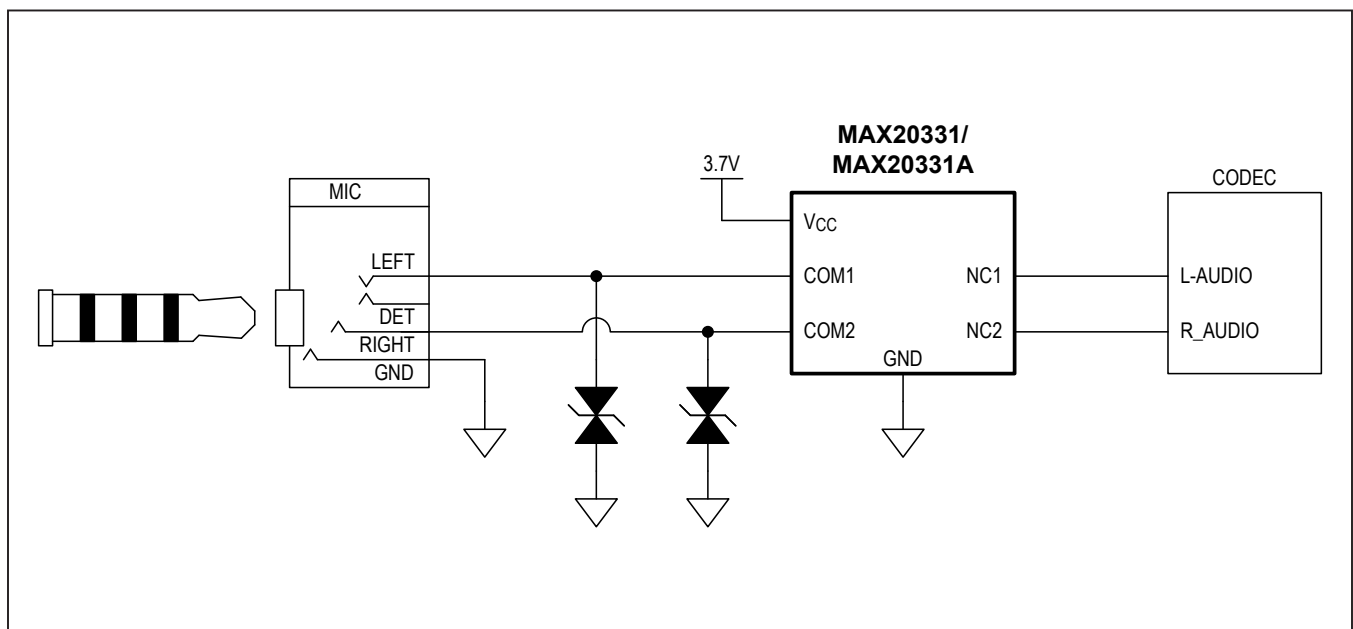

Absolute Maximum Ratings

All voltages are referenced to GND unless otherwise noted.

V _{CC}	-0.3V to +6V
COM_.....	-40V to +40V
VN.....	-40V to +0.3V
NC.....	-6V to +6V
COM_ to NC.....	-40V to +40V
[COM1 - COM2].....	+40V
Continuous Current into Device.....	0.75A

Peak Current (10ms).....	2A
Continuous Power Dissipation (Multilayer Board) (derate 11.91mW/°C above +70°C).....	952.8mW
Operating Temperature Range.....	-40°C to +85°C
Junction Temperature.....	+150°C
Storage Temperature Range.....	-65°C to +150°C
Soldering Temperature (reflow).....	+260°C

Stresses beyond those listed under "Absolute Maximum Ratings" may cause permanent damage to the device. These are stress ratings only, and functional operation of the device at these or any other conditions beyond those indicated in the operational sections of the specifications is not implied. Exposure to absolute maximum rating conditions for extended periods may affect device reliability.

Package Information

PACKAGE TYPE: 9 WLP	
Package Code	W91F1+1
Outline Number	21-100234
Land Pattern Number	Refer to Application Note 1891
THERMAL RESISTANCE, FOUR-LAYER BOARD	
Junction to Ambient (θ_{JA})	83.98°C/W

For the latest package outline information and land patterns (footprints), go to www.maximintegrated.com/packages. Note that a "+", "#", or "-" in the package code indicates RoHS status only. Package drawings may show a different suffix character, but the drawing pertains to the package regardless of RoHS status.

Package thermal resistances were obtained using the method described in JEDEC specification JESD51-7, using a four-layer board. For detailed information on package thermal considerations, refer to www.maximintegrated.com/thermal-tutorial.

Electrical Characteristics

(V_{CC} = 2.5V to 5.5V, T_A = -40°C to +85°C unless otherwise noted. Typical values are at V_{CC} = +2.5V, T_A = +25°C.) (Note 1)

PARAMETER	SYMBOL	CONDITIONS	MIN	TYP	MAX	UNITS	
POWER SUPPLY							
Supply Voltage Range	V _{CC}	MAX20331	1.6		5.5	V	
		MAX20331A	2.5		5.5		
Supply Current	I _{CC}			85	160	µA	
COM1, COM2, NC1, NC2							
COM_ Positive Overvoltage Trip Threshold	V _{OVLO_P}	MAX20331	V _{COM_} rising	3.3	3.45	3.6	V
			V _{COM_} falling	3.22			
		MAX20331A	V _{COM_} rising	5.35	5.5	5.65	
			V _{COM_} falling	5.25			
COM_ Negative Overvoltage Trip Threshold	V _{OVLO_N}	MAX20331	V _{COM_} falling	-3.3	-3.45	-3.6	V
			V _{COM_} rising	-3.22			
		MAX20331A	V _{COM_} falling	-5.35	-5.5	-5.65	
			V _{COM_} rising	-5.25			

Electrical Characteristics (continued)

($V_{CC} = 2.5V$ to $5.5V$, $T_A = -40^{\circ}C$ to $+85^{\circ}C$ unless otherwise noted. Typical values are at $V_{CC} = +2.5V$, $T_A = +25^{\circ}C$.) (Note 1)

PARAMETER	SYMBOL	CONDITIONS	MIN	TYP	MAX	UNITS
COM_ Off Leakage Current	I_{COM_OFF}	$V_{CC} = 0V$, $V_{COM_} = -6V$, $+6V$, $V_{NC_} = 0V$	-1		+1	μA
COM_ On Leakage Current	I_{COM_ON}	MAX20331 $V_{CC} = 3V$, $V_{COM_} =$ $-3V$, $+3V$, $NC_$ floating	-1		+1	μA
		MAX20331A $V_{CC} = 3V$, $V_{COM_} =$ $-5V$, $+5V$, $NC_$ floating	-1		+1	
NC_ Off Leakage Current	I_{NC_OFF}	$V_{CC} = 0V$, $V_{NC_} = -6V$, $+6V$, $V_{COM_} = 0V$	-1		+1	μA
TIMING CHARACTERISTICS (FIGURE 1)						
COM_ Positive Overvoltage Fault Protection Response Time	t_{FP}	$V_{COM_} = 1V$ to $10V$ step, $V_{CC} = 3.0V$, $R_{NC_} = 1k\Omega$		1.2		μs
COM_ Positive Overvoltage Fault Protection Recovery Time	t_{FPR}	$V_{COM_} = 10V$ to $1V$ step, $V_{CC} = 3.0V$, $R_{NC_} = 1k\Omega$		120		μs
COM_ Negative Overvoltage Fault Protection Response Time	t_{FN}	$V_{COM_} = -1V$ to $-10V$ step, $V_{CC} = 3.0V$, $R_{NC_} = 1k\Omega$		1.8		μs
COM_ Negative Overvoltage Fault Protection Recovery Time	t_{FNR}	$V_{COM_} = -10V$ to $-1V$ step, $V_{CC} = 3.0V$, $R_{NC_} = 1k\Omega$		120		μs
SWITCH CHARACTERISTICS						
Analog Switch Range		MAX20331	-3.6		3.6	V
		MAX20331A	-5.65		5.65	
On-Resistance (COM_ to NC_)	R_{ON}	$I_{COM_} = 100mA$		1	1.6	Ω
On-Capacitance		$-3.3V < V_{NC_} < +3.3V$		18		pF
On-Resistance Match Between Channels	ΔR_{ON}	$V_{CC} = 3.3V$, $I_{COM_} = 100mA$, $V_{COM_} = -1V$ to $+1V$ (Note 2)		0.001	0.05	Ω
On-Resistance Flatness	R_{FLAT}	$V_{CC} = 3.3V$, $I_{COM_} = 100mA$, $V_{COM_} = -1V$ to $+1V$ (Note 3)		0.0001	0.015	Ω
PSRR		$f = 20kHz$, $V_{COM_} = 0.4V_{PK-PK}$		-60		dB
Bandwidth	BW	$V_{COM_} = 0.4V_{PK-PK}$, $R_S = R_L = 50\Omega$		350		MHz
Off-Isolation	V_{ISO}	$f = 20kHz$, $V_{COM_} = 0.4V_{PK-PK}$, $R_L = 50\Omega$		-70		dB
Crosstalk	V_{CT}	$f = 20kHz$, $V_{COM_} = 0.4V_{PK-PK}$, $R_L = 50\Omega$		-70		dB
THD+N		$f = 20Hz$ to $20kHz$, $V_{COM_} = 1V_{PK-PK}$, DC bias = $0V$, $R_L = 600\Omega$		-114		dB
		$f = 20Hz$ to $20kHz$, $V_{COM_} = 0.5V_{PK-PK}$, DC bias = $0V$, $R_L = 32\Omega$		-110		

Electrical Characteristics (continued)

($V_{CC} = 2.5V$ to $5.5V$, $T_A = -40^{\circ}C$ to $+85^{\circ}C$ unless otherwise noted. Typical values are at $V_{CC} = +2.5V$, $T_A = +25^{\circ}C$.) (Note 1)

PARAMETER	SYMBOL	CONDITIONS	MIN	TYP	MAX	UNITS
THERMAL PROTECTION						
Thermal Shutdown	T_{SHDN}			150		$^{\circ}C$
Thermal Hysteresis	T_{HYST}			20		$^{\circ}C$
ESD PROTECTION						
HBM		All pins		± 2		kV

Note 1: All devices are 100% production tested at $T_A = +25^{\circ}C$. All temperature limits are guaranteed by design.

Note 2: On-resistance match between channels is defined as $\Delta R_{ON_MAX} = |R_{ON_CH1} - R_{ON_CH2}|$

Note 3: On-resistance flatness is defined as the difference between the maximum and minimum values of on-resistance, as measured over the specified analog signal ranges.

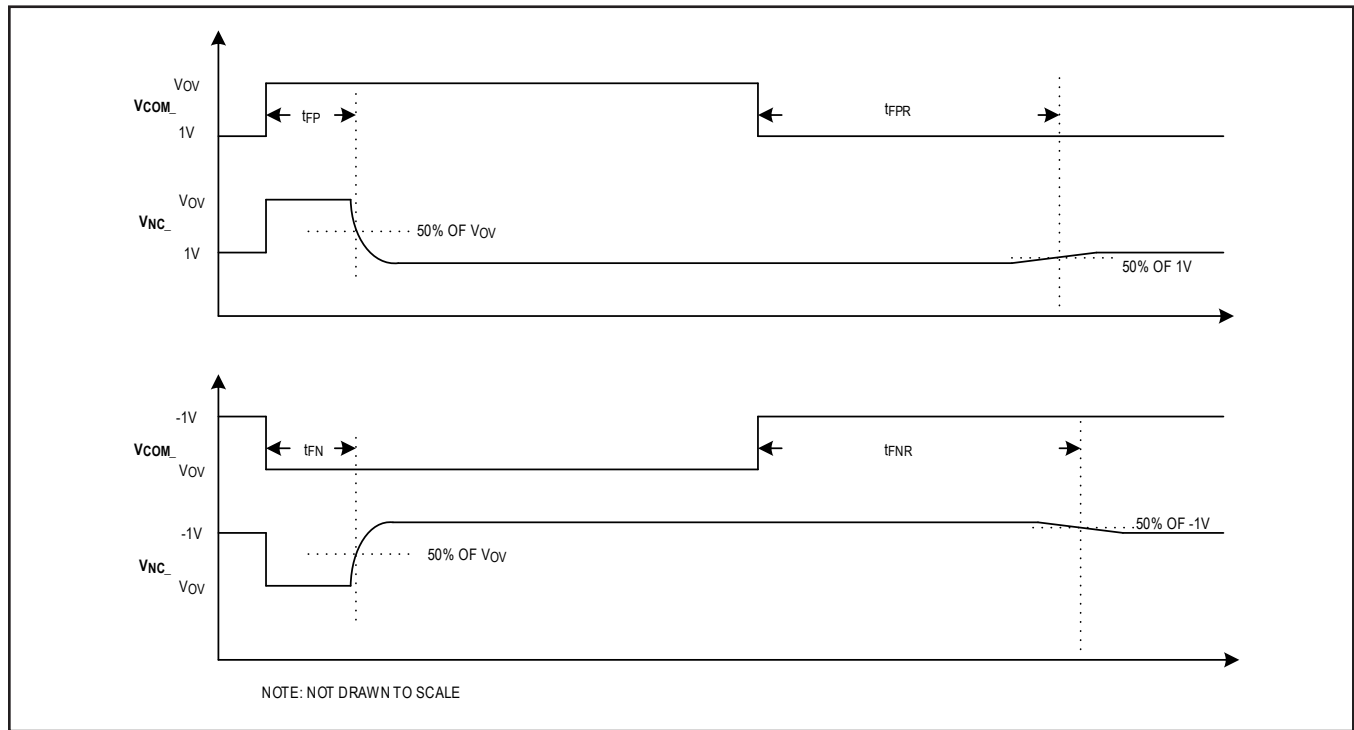
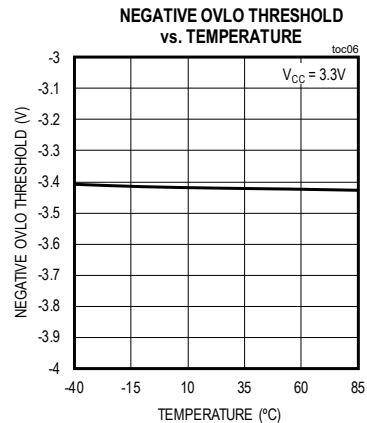
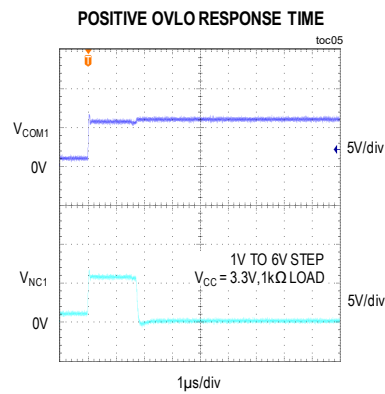
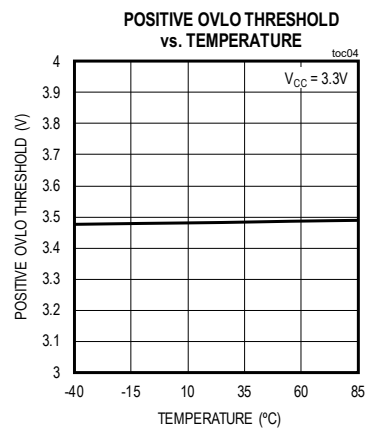
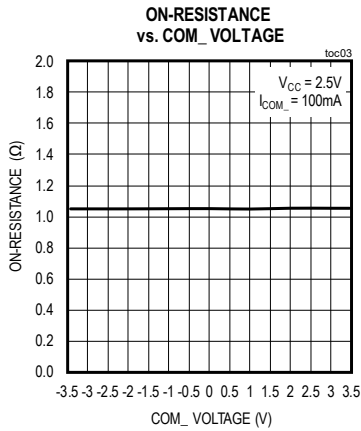
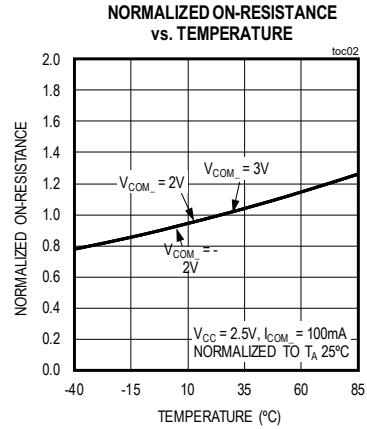
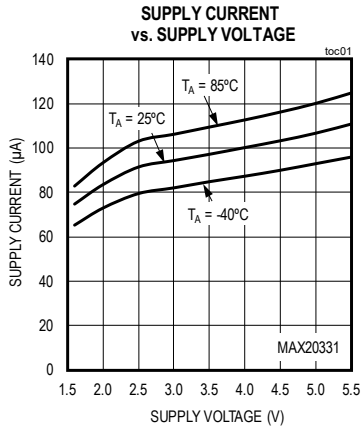

Figure 1. Timing Diagram

Typical Operating Characteristics (continued)

($V_{CC} = +3.7V$, $T_A = +25^\circ C$, unless otherwise noted.)



Typical Operating Characteristics (continued)

($V_{CC} = +3.7V$, $T_A = +25^\circ C$, unless otherwise noted.)

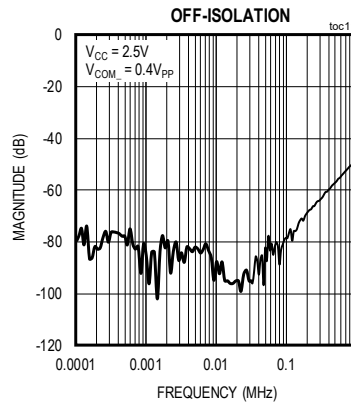
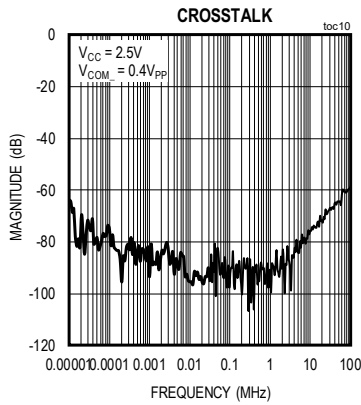
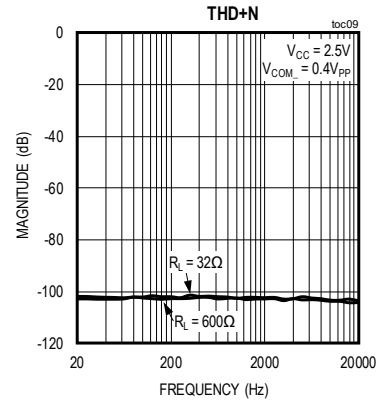
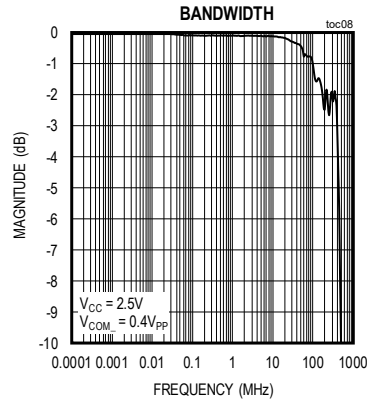
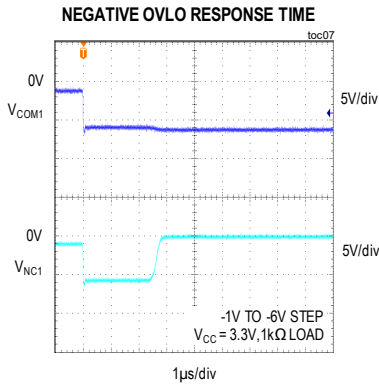

Bump Configurations

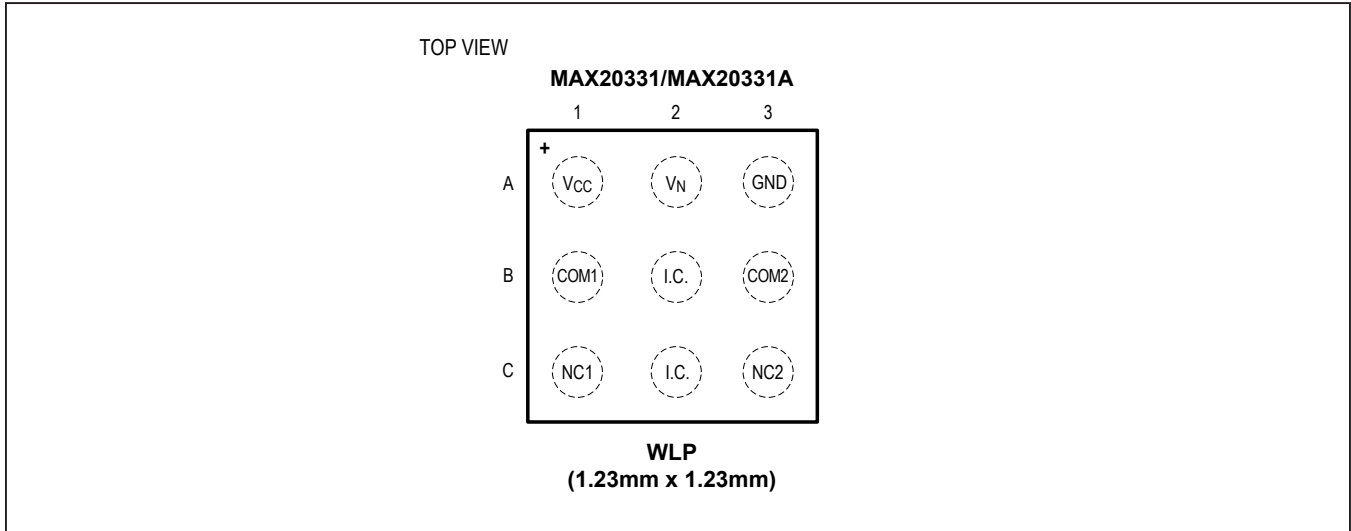

Bump Description

BUMP	NAME	FUNCTION
A1	V _{CC}	Supply Voltage Input. Bypass V _{CC} to ground with a 0.1μF decoupling capacitor as close as possible to the device
A2	V _N	1nF Capacitor Connection. Connect a 1nF capacitor to ground as close as possible to the device.
A3	GND	Ground
B1	COM1	External Audio Line 1. Connect to external audio source.
B2	I.C.	Internally Connected. Connect to GND.
B3	COM2	External Audio Line 2. Connect to external audio source.
C1	NC1	Protected Audio Line 1. Connect to audio codec.
C2	I.C.	Internally Connected. Connect to GND.
C3	NC2	Protected Audio Line 2. Connect to audio codec.

Functional Diagram

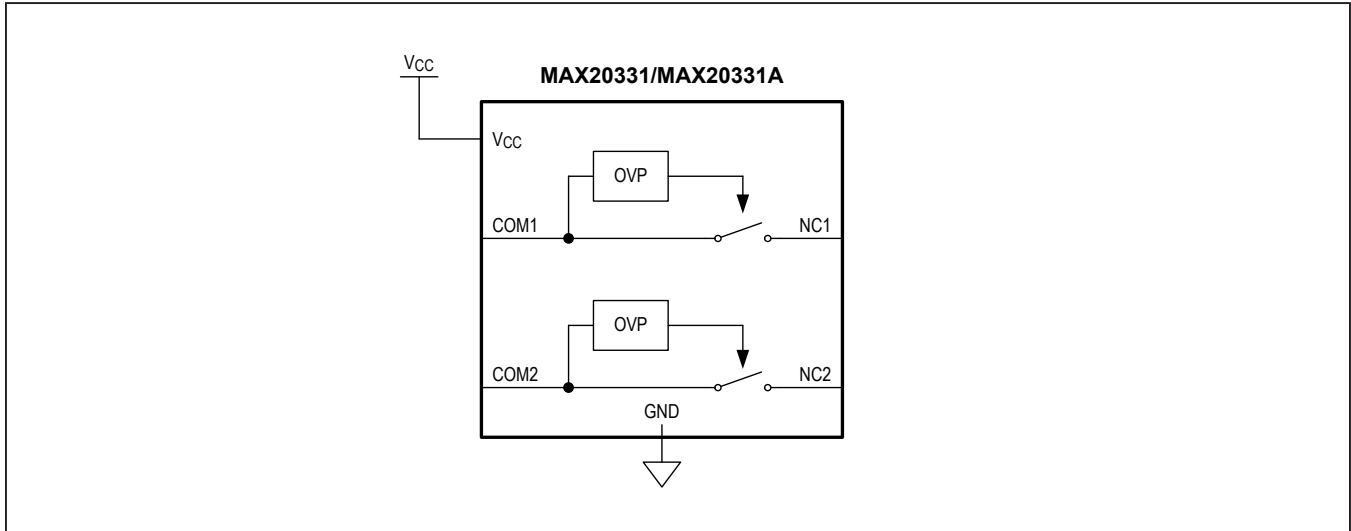

Detailed Description

The MAX20331/MAX20331A OVP devices offer positive and negative over voltage protection for electronics in the audio signal path connected to a 3.5mm audio jack. Both devices offer protection up to $\pm 40V$, well past the over voltage threshold.

When the COM_ voltage reaches the OVP threshold, the COM_ to NC_ path is opened to disconnect sensitive electronics from the over voltage condition. The MAX20331

threshold is $\pm 3.45V$ while the MAX20331A threshold is $\pm 5.5V$. These thresholds are maintained across the full range of supply voltages.

Applications Information

For additional ESD and high-voltage protection, place external ESD protection devices on the COM1 and COM2 lines. These external devices should be bidirectional and no trigger on higher than $\pm 20V$.

Ordering Information

PART	TEMP RANGE	PIN-PACKAGE
MAX20331EWL+	-40°C to +85°C	9 WLP
MAX20331EWL+T	-40°C to +85°C	9 WLP
MAX20331AEWL+	-40°C to +85°C	9 WLP
MAX20331AEWL+T	-40°C to +85°C	9 WLP

+Denotes a lead(Pb)-free/RoHS-compliant package.

T Denotes tape-and-reel

Chip Information

PROCESS: BiCMOS

Revision History



REVISION NUMBER	REVISION DATE	DESCRIPTION	PAGES CHANGED
0	6/18	Initial release	—

For pricing, delivery, and ordering information, please visit Maxim Integrated's online storefront at <https://www.maximintegrated.com/en/storefront/storefront.html>.

Maxim Integrated cannot assume responsibility for use of any circuitry other than circuitry entirely embodied in a Maxim Integrated product. No circuit patent licenses are implied. Maxim Integrated reserves the right to change the circuitry and specifications without notice at any time. The parametric values (min and max limits) shown in the Electrical Characteristics table are guaranteed. Other parametric values quoted in this data sheet are provided for guidance.

Looking for pricing, stock, or lifecycle information?

Click below to explore more details on WIN SOURCE:

-  [View MAX20331EWL+ on WIN SOURCE](#)
-  [Maxim Integrated Information](#)

Optimize Your Supply Chain with WIN SOURCE Solutions

-  Global Sourcing Solution
-  Obsolete Management
-  Cost Control Management
-  Shortage Management
-  Alternative Solution
-  Excess Inventory Management