



**THE DATASHEET OF
M81705FP**



HVIC

High Voltage Integrated Circuit
600 Volts/+150mA/-125mA

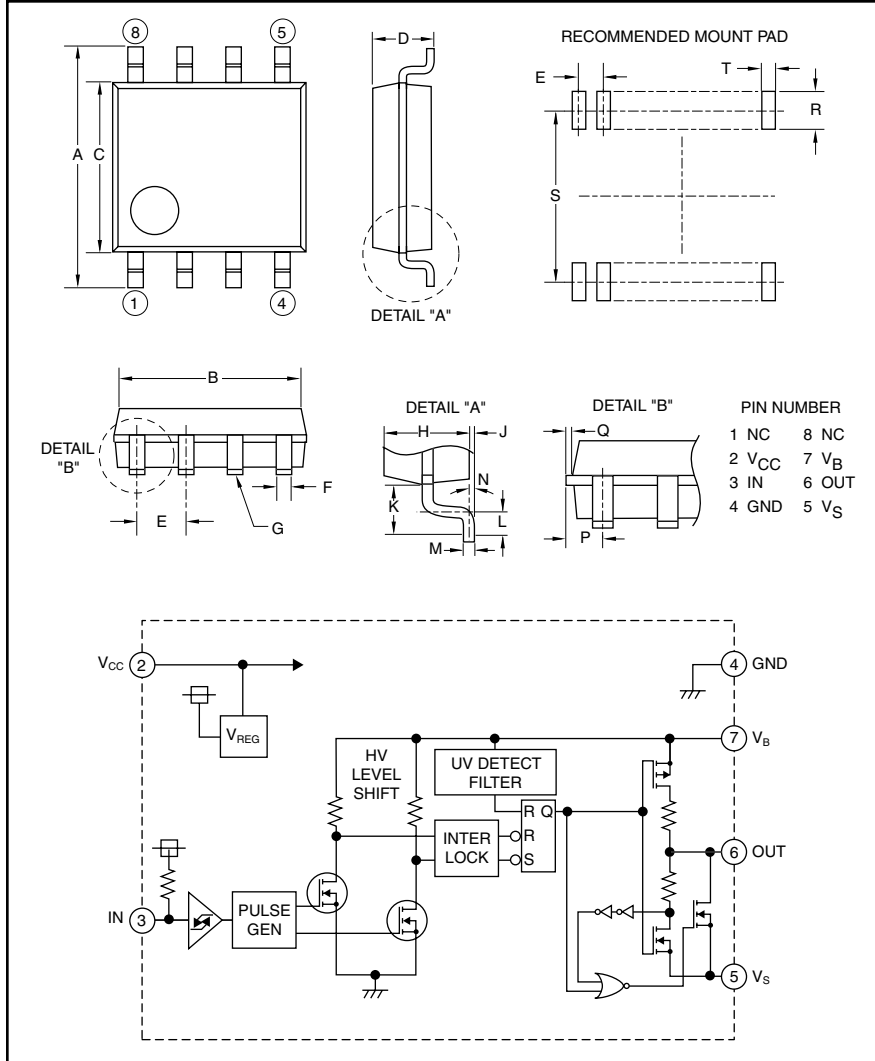

Outline Drawing and Circuit Diagram

Dimensions	Inches	Millimeters
A	0.25	6.5
B	0.21	5.2
C	0.18	4.6
D	0.08	1.9
E	0.05	1.27
F	0.02	0.5
G	0.004	0.1
H	0.06	1.5
J	0.002	0.05

Dimensions	Inches	Millimeters
K	0.04	0.9
L	0.03	0.6
M	0.008	0.2
N	10°	10°
P	0.023	0.595
Q	0.03	0.745
R	0.05	1.27
S	0.23	5.72
T	0.76	0.76

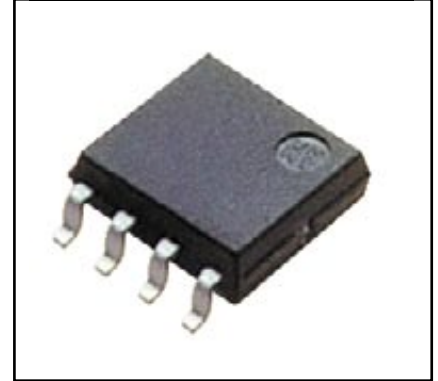

Description:

M81705FP is a high voltage Power MOSFET and IGBT module driver for half-bridge applications.

Features:

- Floating Supply Voltage
- Output Current
- Half-Bridge Driver
- SOP-8

Applications:

- HID
- PDP
- MOSFET Driver
- IGBT Driver
- Inverter Module Control

Ordering Information:

M81705FP is a $\pm 150/-125$ mA, 600 Volt HVIC, High Voltage Integrated Circuit



Powerex, Inc., 200 E. Hillis Street, Youngwood, Pennsylvania 15697-1800 (724) 925-7272

M81705FP

HVIC, High Voltage Integrated Circuit

600 Volts/+150mA/-125mA

Absolute Maximum Ratings, $T_a = 25^\circ\text{C}$ unless otherwise specified

Characteristics	Symbol	M81705FP	Units
High Side Floating Supply Absolute Voltage	V_B	-0.5 ~ 624	Volts
High Side Floating Supply Offset Voltage	V_S	$V_B - 24 \sim V_B + 0.5$	Volts
High Side Floating Supply Voltage ($V_{BS} = V_B - V_S$)	V_{BS}	-0.5 ~ 24	Volts
High Side Output Voltage	V_{OUT}	$V_S - 0.5 \sim V_B + 0.5$	Volts
Low Side Fixed Supply Voltage	V_{CC}	-0.5 ~ 24	Volts
Logic Input Voltage	V_{IN}	-0.5 ~ 5.5	Volts
Allowable Offset Supply Voltage Transient	dV_S/dt	± 50	V/ns
Package Power Dissipation ($T_a = 25^\circ\text{C}$, On Board)	P_d	0.60	Watts
Linear Derating Factor ($T_a > 25^\circ\text{C}$, On Board)	K_θ	-6.0	mW/°C
Junction to Case Thermal Resistance	$R_{th(j-c)}$	50	°C/W
Junction Temperature	T_j	-20 ~ 125	°C
Operation Temperature	T_{opr}	-20 ~ 100	°C
Storage Temperature	T_{stg}	-40 ~ 125	°C

Recommended Operating Conditions

Characteristics	Symbol	Test Conditions	Min.	Typ.	Max.	Units
High Side Floating Supply Absolute Voltage	V_B		$V_S + 13.5$	—	$V_S + 20$	Volts
High Side Floating Supply Offset Voltage	V_S	$V_B > 13.5\text{V}$	-5	—	500	Volts
High Side Floating Supply Voltage	V_{BS}	$V_B = V_B - V_S$	13.5	—	20	Volts
Low Side Fixed Supply Voltage	V_{CC}		13.5	—	20	Volts
Logic Input Voltage	V_{IN}		0	—	5	Volts

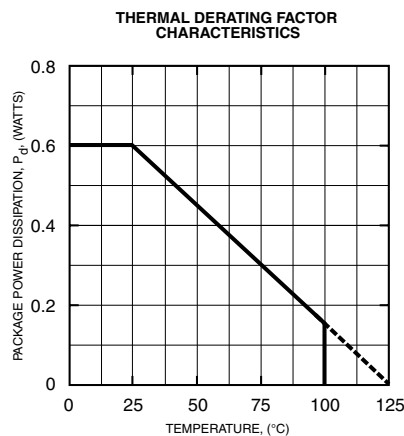



Powerex, Inc., 200 E. Hillis Street, Youngwood, Pennsylvania 15697-1800 (724) 925-7272

M81705FP

HVIC, High Voltage Integrated Circuit

600 Volts/+150mA/-125mA

Electrical Characteristics

T_a = 25°C, V_{CC} = V_{BS} (= V_B - V_S) = 15V unless otherwise specified

Characteristics	Symbol	Test Conditions	Min.	Typ. *	Max.	Units
Floating Supply Leakage Current	I _{FS}	V _B = V _S = 600V	—	—	1.0	μA
V _{BS} Standby Current	I _{BS}		0.25	0.50	0.75	mA
V _{CC} Standby Current	I _{CC}		0.50	0.75	1.00	mA
High Level Output Voltage	V _{OH}	I _O = 0A	14.9	—	—	Volts
Low Level Output Voltage	V _{OL}	I _O = 0A	—	—	0.1	Volts
High Level Input Threshold Voltage	V _{IH}		2.5	3.0	4.0	Volts
Low Level Input Threshold Voltage	V _{IL}		0.8	1.5	2.0	Volts
High Level Input Bias Current	I _{IH}	V _{IN} = 5V	-50	-20	—	μA
Low Level Input Bias Current	I _{IL}	V _{IN} = 0V	-200	-100	—	μA
V _{BS} Supply UV Reset Voltage	V _{BSuvr}		10.5	11.5	12.5	Volts
V _{BS} Supply UV Hysteresis Voltage	V _{BSuvh}		0.2	0.5	0.8	Volts
V _{BS} Supply UV Filter Time	t _{VBSuv}		—	5	—	μs
Output High Level Short Circuit Pulsed Current	I _{OH}	V _O = 0V, V _{IN} = 0V, P _W < 10μs	—	-125	—	mA
Output Low Level Short Circuit Pulsed Current	I _{OL1}	V _O = 1V, V _{IN} = 5V, P _W < 10μs	—	40	—	mA
Output Low Level Short Circuit Pulsed Current	I _{OL2}	V _O = 15V, V _{IN} = 5V, P _W < 10μs	—	150	—	mA
Output High Level ON Resistance	R _{OH}	I _O = -100mA, R _{OH} = (V _{OH} - V _O)/I _O	—	120	160	Ω
Output Low Level ON Resistance1	R _{OL1}	V _O = 1V, R _{OL1} = V _O /I _O	—	50	60	Ω
Output Low Level ON Resistance2	R _{OL2}	V _O = 5V, R _{OL2} = V _O /I _O	—	100	130	Ω
High Side Turn-On Propagation Delay	t _{dLH}	C _L = 1000pF between OUT - V _S	100	—	500	ns
High Side Turn-Off Propagation Delay	t _{dHL}	C _L = 1000pF between OUT - V _S	100	—	500	ns
High Side Turn-On Rise Time	t _r	C _L = 1000pF between OUT - V _S	—	220	—	ns
High Side Turn-Off Fall Time	t _f	C _L = 1000pF between OUT - V _S	—	110	—	ns
R _{OL1} /R _{OL2} Switching Output Voltage	V _{Oth}		1.5	2.5	4.0	Volts

*Typical is not specified.



Powerex, Inc., 200 E. Hillis Street, Youngwood, Pennsylvania 15697-1800 (724) 925-7272

M81705FP
HVIC, High Voltage Integrated Circuit
 600 Volts/+150mA/-125mA

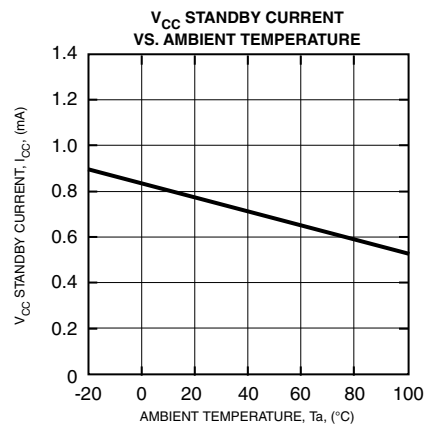
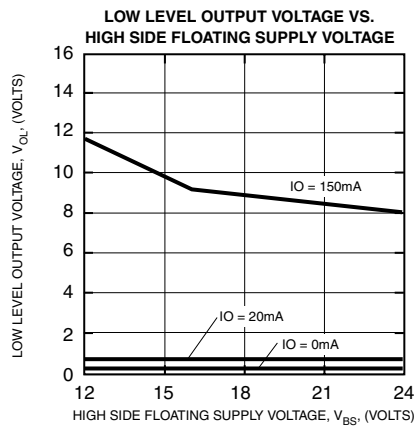
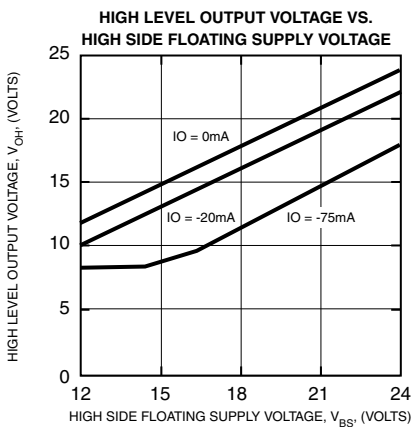
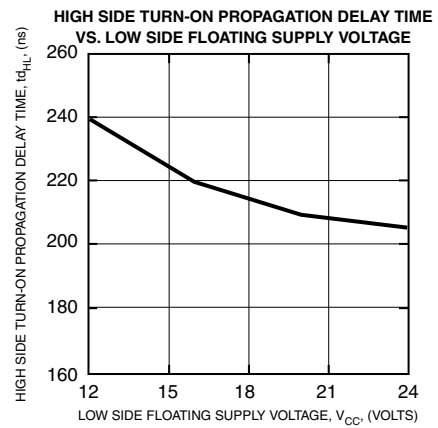
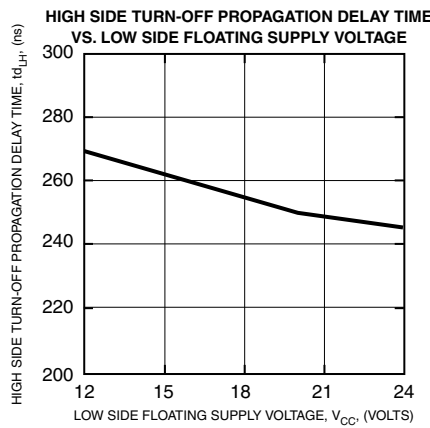
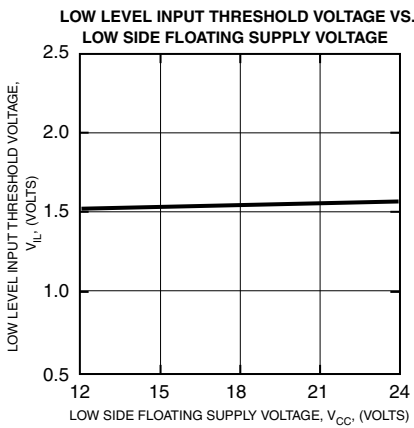
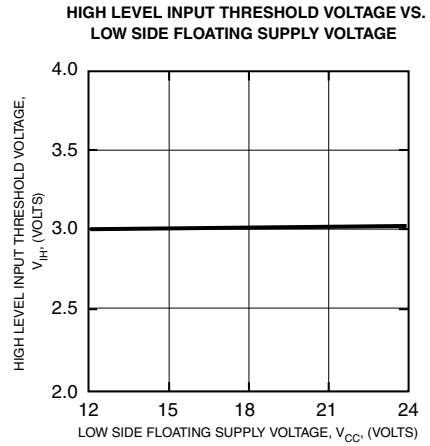
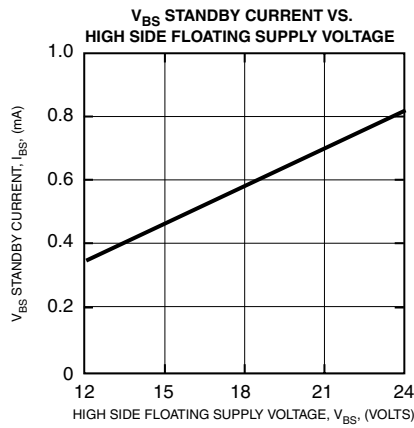
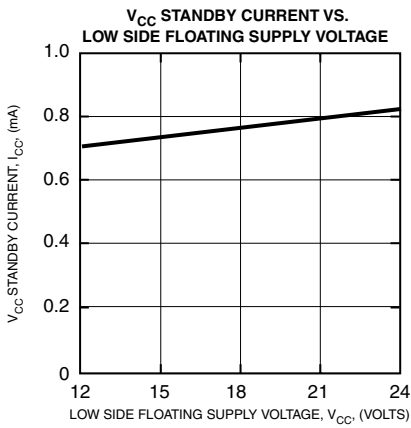



Powerex, Inc., 200 E. Hillis Street, Youngwood, Pennsylvania 15697-1800 (724) 925-7272

M81705FP

HVIC, High Voltage Integrated Circuit
600 Volts/+150mA/-125mA

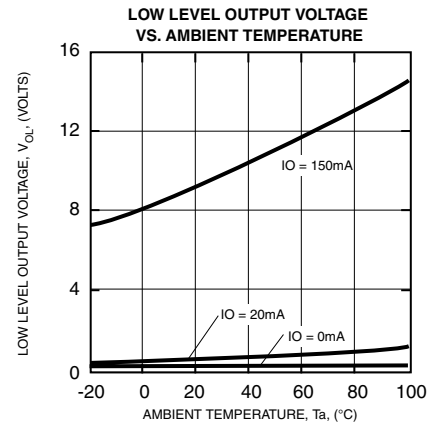
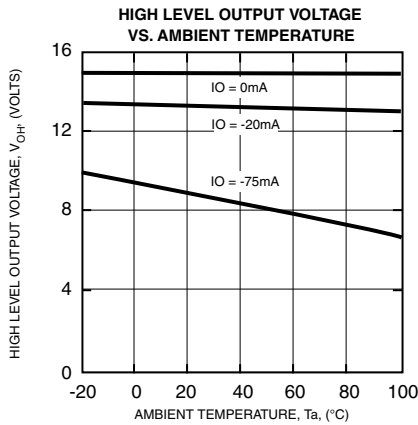
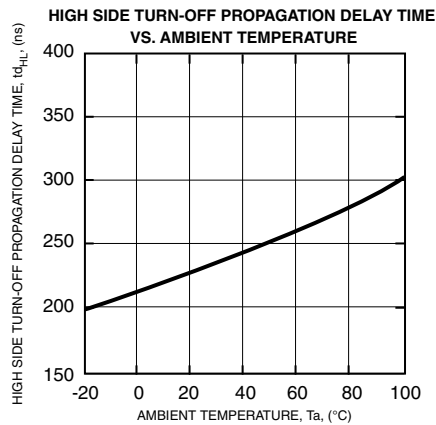
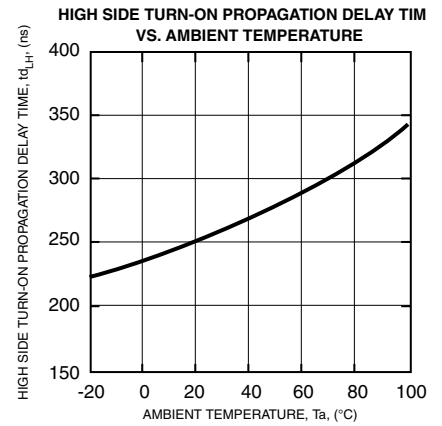
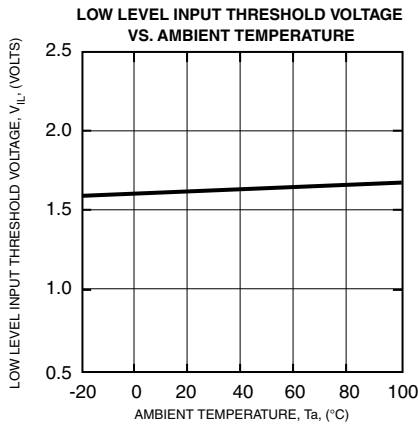
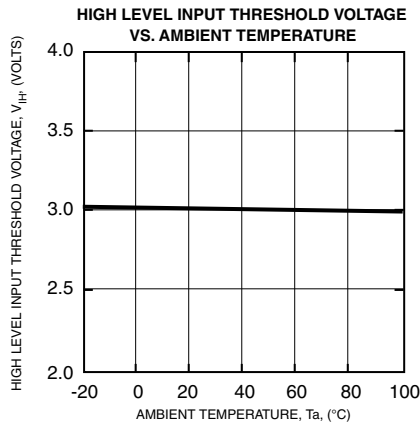
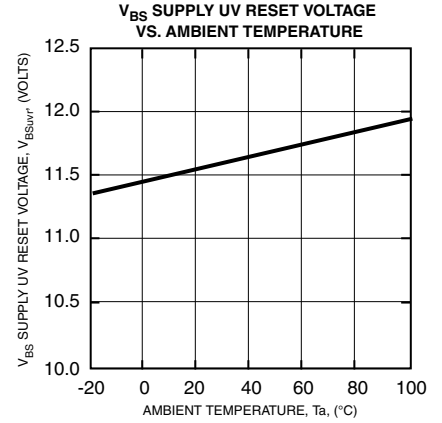
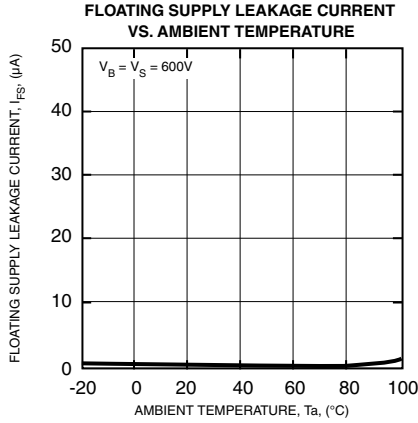
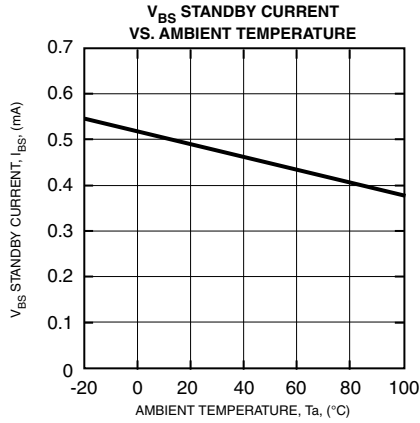

M81705FP

HVIC, High Voltage Integrated Circuit

600 Volts/+150mA/-125mA

LOW LEVEL OUTPUT SHORT CIRCUIT PULSED CURRENT VS. LOW LEVEL OUTPUT VOLTAGE (R_{OL1}/R_{OL2} SWITCHING OUTPUT VOLTAGE)

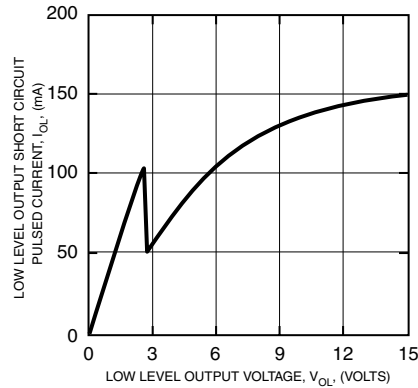

TIMING DIAGRAM

1. Input/Output Timing Diagram

When input signal "L", then output signal is "H".

2. V_{BS} Supply Under Voltage Lockout Timing Diagram

When V_{BS} supply voltage keeps lower UV trip voltage (V_{BSuvt} = V_{BSuvr} - V_{BSuvh}) for V_{BS} supply UV filter time, output signal becomes "L". And then, V_{BS} supply voltage is higher UV reset voltage, output signal keeps "L" until next input signal is "L".

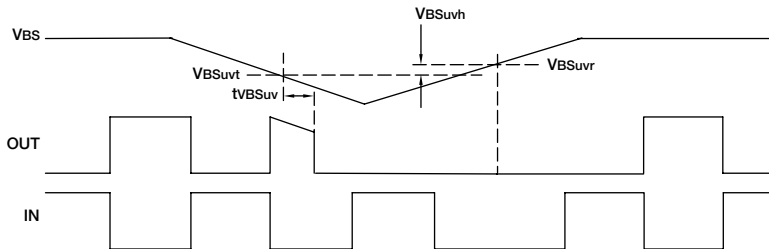

3. Allowable Supply Voltage Transient

Firstly, supply V_{CC} with voltage. Secondly, supply V_{BS} with voltage. In the case of shutting off supply voltage, shut off V_{BS} Supply Voltage firstly. Secondly, shut off V_{CC} Supply Voltage. In case V_{BS} or V_{CC} is started too fast, output signal may be "H".

4. ROL1 / ROL2 Switching Output Voltage V_{Oth}

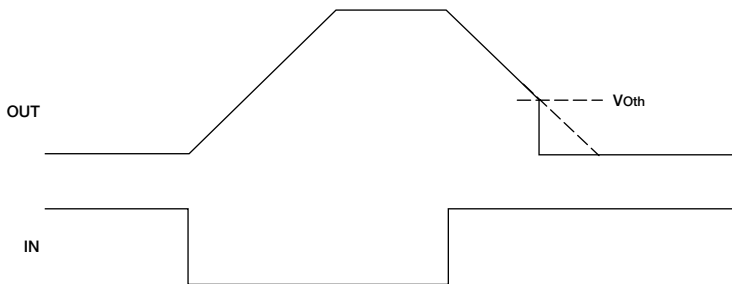

As shown by the solid line of the timing chart, the output on-resistance drops at "V_{Oth}" level when the output is in the "L" state (output level falls). Below the "V_{Oth}" level, the output level falls more steeply.

Looking for pricing, stock, or lifecycle information?

Click below to explore more details on WIN SOURCE:

 [View M81705FP on WIN SOURCE](#)

 [Powerex Inc. Information](#)

Optimize Your Supply Chain with WIN SOURCE Solutions

-  Global Sourcing Solution
-  Obsolete Management
-  Cost Control Management
-  Shortage Management
-  Alternative Solution
-  Excess Inventory Management