



THE DATASHEET OF LM4852ITLX/NOPB



LM4852 Boomer® Audio Power Amplifier Series Integrated Audio Amplifier System

Check for Samples: [LM4852](#)

FEATURES

- 1.1W (typ) Output Power with 8Ω Mono BTL Load
- 60mW (typ) Output Power with Stereo 32Ω SE Loads
- I²C Programmable 32 Step Digital Volume Control (-40.5dB to +6dB)
- Eight Distinct Output Modes
- DSBGA and WQFN Surface Mount Packaging
- "Click and Pop" Suppression Circuitry
- Thermal Shutdown Protection
- Low Shutdown Current (0.1uA, Typ)

APPLICATIONS

- Mobile Phones
- PDAs

KEY SPECIFICATIONS

- THD+N at 1kHz, 1.1W into 8Ω BTL, 1.0% (Typ)
- THD+N at 1kHz, 60mW into 32Ω SE, 0.5% (Typ)
- Single Supply Operation, 2.6 to 5.0V

DESCRIPTION

The LM4852 is an audio power amplifier system capable of delivering 1.1W (typ) of continuous average power into a mono 8Ω bridged-tied load (BTL) with 1% THD+N and 60mW (typ) per channel of continuous average power into stereo 32Ω single-ended (SE) loads with 0.5% THD+N, using a 5V power supply.

The LM4852 features a 32 step digital volume control and eight distinct output modes. The digital volume control and output modes are programmed through a two-wire I²C compatible control interface, that allows flexibility in routing and mixing audio channels. The LM4852 has 3 channels: one pair for a two-channel stereo signal and the third for a single-channel mono input.

The LM4852 is designed for cellular phone, PDA, and other portable handheld applications. It delivers high quality output power from a surface-mount package and requires only seven external components.

The industry leading DSBGA package only utilizes 2mm x 2.3mm of PCB space, making the LM4852 the most space efficient audio sub system available today.

Typical Application

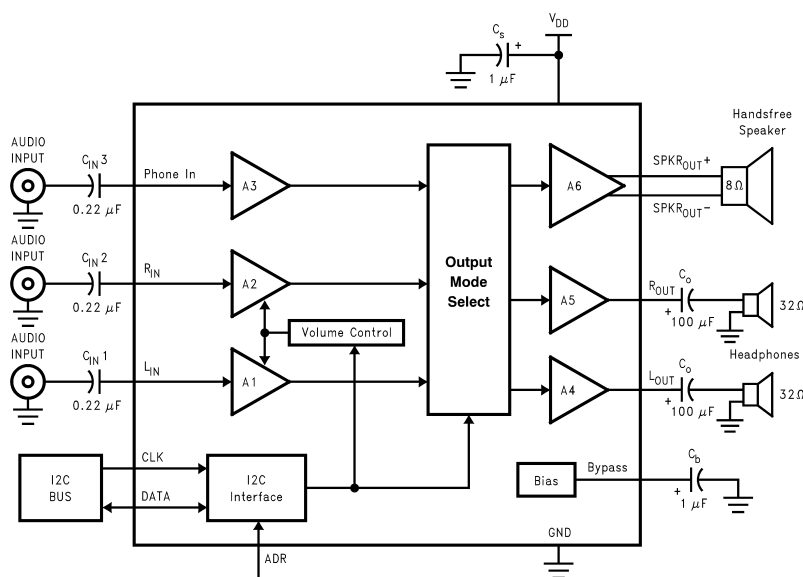

Figure 1. Typical Audio Amplifier Application Circuit



Please be aware that an important notice concerning availability, standard warranty, and use in critical applications of Texas Instruments semiconductor products and disclaimers thereto appears at the end of this data sheet.

All trademarks are the property of their respective owners.

Connection Diagram

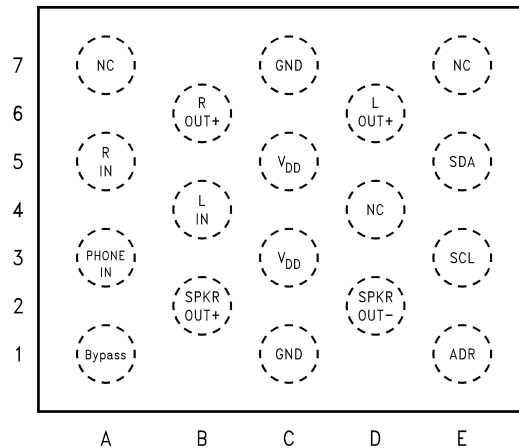

**Figure 2. Top View
(Bump-side down)
See Package Number YZR0018**

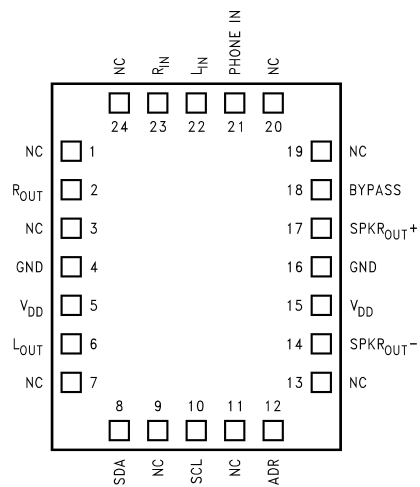

**Figure 3. WQFN Package
Top View
See Package Number NHW0024B for WQFN**



These devices have limited built-in ESD protection. The leads should be shorted together or the device placed in conductive foam during storage or handling to prevent electrostatic damage to the MOS gates.

Absolute Maximum Ratings⁽¹⁾⁽²⁾

Supply Voltage		6.0V
Storage Temperature		-65°C to +150°C
ESD Susceptibility ⁽³⁾		2.0kV
ESD Machine model ⁽⁴⁾		200V
Junction Temperature (T _J)		150°C
Vapor Phase (60 sec.)		215°C
Infrared (15 sec.)		220°C
Thermal Resistance	θ _{JA} (typ) - NHW0024B	42°C/W
	θ _{JC} (typ) - NHW0024B	3.0°C/W
	θ _{JA} (typ) - YZR0018	48°C/W ⁽⁵⁾
	θ _{JC} (typ) - YZR0018	23°C/W ⁽⁵⁾

- (1) Absolute Maximum Rating indicate limits beyond which damage to the device may occur.
- (2) If Military/Aerospace specified devices are required, please contact the Texas Instruments Sales Office/Distributors for availability and specifications.
- (3) Human body model, 100pF discharged through a 1.5kΩ resistor.
- (4) Machine Model ESD test is covered by specification EIAJ IC-121-1981. A 200pF cap is charged to the specified voltage, then discharged directly into the IC with no external series resistor (resistance of discharge path must be under 50Ω).
- (5) The given θ_{JA} and θ_{JC} are for an LM4852 mounted on a demonstration board with a 4in² area of 1oz printed circuit board copper ground plane.

Operating Ratings⁽¹⁾

Temperature Range	-40°C to 85°C
Supply Voltage V _{DD}	2.6V ≤ V _{DD} ≤ 5.5V

- (1) Operating Ratings indicate conditions for which the device is functional, but do not ensure specific performance limits. For ensured specifications and test conditions, see the Electrical Characteristics. The ensured specifications apply only for the test conditions listed. Some performance characteristics may degrade when the device is not operated under the listed test conditions.

Electrical Characteristics 5.0 V⁽¹⁾⁽²⁾

The following specifications apply for $V_{DD} = 5.0V$, $T_A = 25^\circ C$ unless otherwise specified.

Symbol	Parameter	Conditions	LM4852		Units (Limits)	
			Typical ⁽³⁾	Limits ⁽⁴⁾ (⁽⁵⁾)		
I_{DD}	Supply Current	Output modes 2, 4, 6 $V_{IN} = 0V$; No loads	5	9	mA (max)	
		Output modes 2, 4, 6 $V_{IN} = 0V$; Loaded (Figure 1)	6	10	mA (max)	
		Output modes 1, 3, 5, 7 $V_{IN} = 0V$; No loads	7.5	11	mA (max)	
		Output modes 1, 3, 5, 7 $V_{IN} = 0V$; Loaded (Figure 1)	8.5	12	mA (max)	
I_{SD}	Shutdown Current	Output mode 0	0.1	2.0	μA (max)	
V_{OS}	Output Offset Voltage	$V_{IN} = 0V$	5.0	40	mV (max)	
P_O	Output Power	SPKR _{OUT} ; $R_L = 4\Omega$ THD+N = 1%; $f = 1kHz$, LM4852LQ	1.5		W	
		SPKR _{OUT} ; $R_L = 8\Omega$ THD+N = 1%; $f = 1kHz$	1.1	0.8	W (min)	
		R_{OUT} and L_{OUT} ; $R_L = 32\Omega$ THD+N = 0.5%; $f = 1kHz$	60	45	mW (min)	
THD+N	Total Harmonic Distortion Plus Noise	SPKR _{OUT} $f = 20Hz$ to $20kHz$ $P_{OUT} = 400mW$; $R_L = 8\Omega$	0.5		%	
		R_{OUT} and L_{OUT} $f = 20Hz$ to $20kHz$ $P_{OUT} = 15mW$; $R_L = 32\Omega$	0.5		%	
N_{OUT}	Output Noise	A-weighted ⁽⁶⁾	26		μV	
PSRR	Power Supply Rejection Ratio SPKR _{OUT}	$V_{RIPPLE} = 200mV_{PP}$; $f = 217Hz$, $C_B = 1.0\mu F$ All audio inputs terminated into 50Ω ; Output referred Gain (BTL) = 6dB				
		Output Mode 1,7	64	57	dB (min)	
		Output Mode 3	58		dB	
		Output Mode 5	55		dB	
	Power Supply Rejection Ratio R_{OUT} and L_{OUT}	$V_{RIPPLE} = 200mV_{PP}$; $f = 217Hz$ $C_B = 1.0\mu F$ All audio inputs terminated into 50Ω ; Output referred Maximum gain setting				
		Output Mode 2	68	59	dB (min)	
		Output Mode 4	60	54	dB (min)	
Output Mode 6, 7	56	51	dB (min)			
V_{IH}	Logic High Input Voltage			$0.7 \times V_{DD}$ V_{DD}	V (min) V (max)	
V_{IL}	Logic Low Input Voltage			0.4 GND	V (max) V (min)	

- (1) Operating Ratings indicate conditions for which the device is functional, but do not ensure specific performance limits. For ensured specifications and test conditions, see the Electrical Characteristics. The ensured specifications apply only for the test conditions listed. Some performance characteristics may degrade when the device is not operated under the listed test conditions.
- (2) All voltages are measured with respect to the ground pin, unless otherwise specified.
- (3) Typical specifications are specified at $+25^\circ C$ and represent the most likely parametric norm.
- (4) Tested limits are ensured to Texas Instruments AOQL (Average Outgoing Quality Level).
- (5) Datasheet min/max specifications are ensured by design, test, or statistical analysis.
- (6) Please refer to the Output Noise vs Output Mode table in the [Typical Performance Characteristics](#) section for more details.

Electrical Characteristics 5.0 V⁽¹⁾⁽²⁾ (continued)

The following specifications apply for $V_{DD} = 5.0V$, $T_A = 25^\circ C$ unless otherwise specified.

Symbol	Parameter	Conditions	LM4852		Units (Limits)
			Typical ⁽³⁾	Limits ⁽⁴⁾ (5)	
	Digital Volume Range (R_{IN} and L_{IN})	Input referred minimum gain	-40.5	-41.1 -39.9	dB (min) dB (max)
		Input referred maximum gain	6.0	5.4 6.6	dB (min) dB (max)
	Digital Volume Stepsize		1.5		dB
	Digital Volume Stepsize Error		±0.1	±0.6	dB (max)
	Phone In Volume	BTL gain from Phone In to $SPKR_{OUT}$	6	5.4 6.6	dB (min) dB (max)
	Mute Attenuation	Output Mode 1, 3, 5	100		dB
	Phone In Input Impedance		20	15 25	kΩ (min) kΩ (max)
	R_{IN} and L_{IN} Input Impedance	Maximum gain setting	30	22.5 37.5	kΩ (min) kΩ (max)
		Minimum gain setting	100	75 125	kΩ (min) kΩ (max)
T_{SD}	Thermal Shutdown Temperature		170	150	°C (min)
t_1	SCL (Clock) Period			2.5	μs (min)
t_2	SDA to SCL Set-up Time			100	ns (min)
t_3	Data Out Stable Time			0	ns (min)
t_4	Start Condition Time			100	ns (min)
t_5	Stop Condition Time			100	ns (min)

Electrical Characteristics 3.0V⁽¹⁾⁽²⁾

The following specifications apply for $V_{DD} = 3.0V$, $T_A = 25^\circ C$ unless otherwise specified.

Symbol	Parameter	Conditions	LM4852		Units (Limits)	
			Typical ⁽³⁾	Limits ⁽⁴⁾⁽⁵⁾		
I_{DD}	Supply Current	Output modes 2, 4, 6 $V_{IN} = 0V$; No loads	4	7	mA (max)	
		Output modes 2, 4, 6 $V_{IN} = 0V$; Loaded (Figure 1)	5	8	mA (max)	
		Output modes 1, 3, 5, 7 $V_{IN} = 0V$; No loads	6.5	10	mA (max)	
		Output modes 1, 3, 5, 7 $V_{IN} = 0V$; Loaded (Figure 1)	7	11	mA (max)	
I_{SD}	Shutdown Current	Output mode 0	0.1	2.0	μA (max)	
V_{OS}	Output Offset Voltage	$V_{IN} = 0V$	5.0	40	mV (max)	
P_O	Output Power	SPKR _{OUT} ; $R_L = 4\Omega$ THD+N = 1%; $f = 1kHz$, LM4852LQ	430		mW	
		SPKR _{OUT} ; $R_L = 8\Omega$ THD+N = 1%; $f = 1kHz$	340	300	mW (min)	
		R_{OUT} and L_{OUT} ; $R_L = 32\Omega$ THD+N = 0.5%; $f = 1kHz$	22	18	mW (min)	
THD+N	Total Harmonic Distortion Plus Noise	SPKR _{OUT} $f = 20Hz$ to $20kHz$ $P_{OUT} = 150mW$; $R_L = 8\Omega$	0.5		%	
		R_{OUT} and L_{OUT} $f = 20Hz$ to $20kHz$ $P_{OUT} = 10mW$; $R_L = 32\Omega$	0.5		%	
N_{OUT}	Output Noise	A-weighted ⁽⁶⁾	26		μV	
PSRR	Power Supply Rejection Ratio SPKR _{OUT}	$V_{RIPPLE} = 200mV_{PP}$; $f = 217Hz$, $C_B = 1.0\mu F$ All audio inputs terminated into 50Ω ; Output referred Gain (BTL) = 6dB				
		Output Mode 1, 7	64	57	dB (min)	
		Output Mode 3	58		dB	
		Output Mode 5	55		dB	
	Power Supply Rejection Ratio R_{OUT} and L_{OUT}	$V_{RIPPLE} = 200mV_{PP}$; $f = 217Hz$, $C_B = 1.0\mu F$ All audio inputs terminated into 50Ω ; Output referred Maximum gain setting				
		Output Mode 2	68	60	dB (min)	
		Output Mode 4	60	55	dB (min)	
	Output Mode 6, 7	56	52	dB (min)		
V_{IH}	Logic High Input Voltage			$0.7 \times V_{DD}$ V_{DD}	V (min) V (max)	
V_{IL}	Logic Low Input Voltage			0.4 GND	V (max) V (min)	

(1) Absolute Maximum Rating indicate limits beyond which damage to the device may occur.

(2) All voltages are measured with respect to the ground pin, unless otherwise specified.

(3) Typical specifications are specified at $+25^\circ C$ and represent the most likely parametric norm.

(4) Tested limits are ensured to Texas Instruments AOQL (Average Outgoing Quality Level).

(5) Datasheet min/max specifications are ensured by design, test, or statistical analysis.

(6) Please refer to the Output Noise vs Output Mode table in the [Typical Performance Characteristics](#) section for more details.

Electrical Characteristics 3.0V⁽¹⁾⁽²⁾ (continued)

The following specifications apply for $V_{DD} = 3.0V$, $T_A = 25^\circ C$ unless otherwise specified.

Symbol	Parameter	Conditions	LM4852		Units (Limits)
			Typical ⁽³⁾	Limits ⁽⁴⁾⁽⁵⁾	
	Digital Volume Range (R_{IN} and L_{IN})	Input referred minimum gain	-40.5	-41.1 -39.9	dB (min) dB (max)
		Input referred maximum gain	6.0	5.4 6.6	dB (min) dB (max)
	Digital Volume Stepsize		1.5		dB
	Digital Volume Stepsize Error		±0.1	±0.6	dB (max)
	Phone In Volume	BTL gain from Phone In to $SPKR_{OUT}$	6	5.4 6.6	dB (min) dB (max)
	Mute Attenuation	Output Mode 1, 3, 5	100		dB
	Phone In Input Impedance		20	15 25	kΩ (min) kΩ (max)
	R_{IN} and L_{IN} Input Impedance	Maximum gain setting	30	22.5 37.5	kΩ (min) kΩ (max)
Minimum gain setting		100	75 125	kΩ (min) kΩ (max)	
T_{SD}	Thermal Shutdown Temperature		170	150	°C (min)
t_1	SCL (Clock) Period			2.5	μs (min)
t_2	SDA to SCL Set-up Time			100	ns (min)
t_3	Data Out Stable Time			0	ns (min)
t_4	Start Condition Time			100	ns (min)
t_5	Stop Condition Time			100	ns (min)

External Components Description

Components		Functional Description
1.	C_{IN}	This is the input coupling capacitor. It blocks the DC voltage and couples the input signal to the amplifier's input terminals. C_{IN} also creates a highpass filter with the internal resistor R_i (Input Impedance) at $f_c = 1/(2\pi R_i C_{IN})$.
2.	C_S	This is the supply bypass capacitor. It filters the supply voltage applied to the V_{DD} pin and helps maintain the LM4852's PSRR.
3.	C_B	This is the BYPASS pin capacitor. It filters the $V_{DD} / 2$ voltage and helps maintain the LM4852's PSRR.

Typical Performance Characteristics

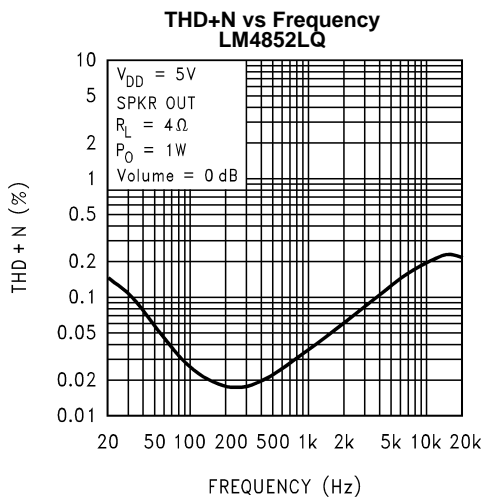

Figure 4.

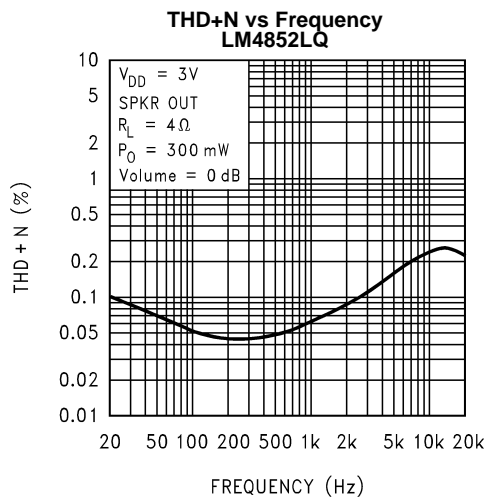

Figure 5.

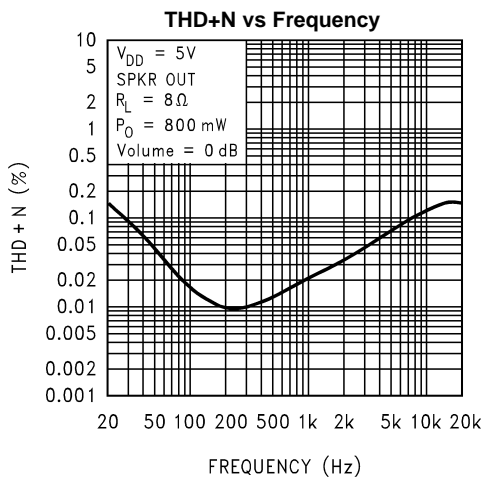

Figure 6.

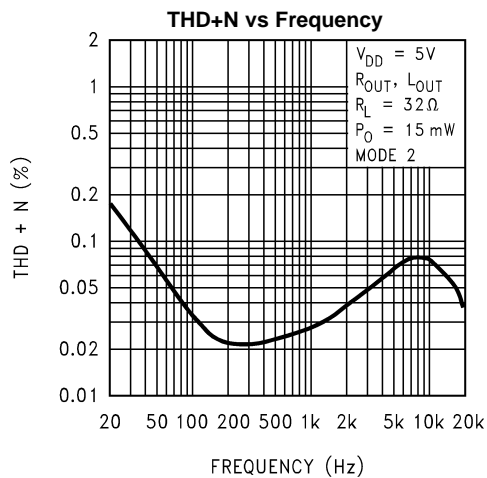

Figure 7.

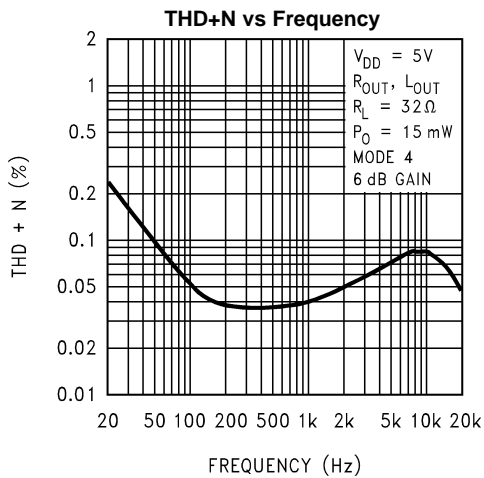

Figure 8.

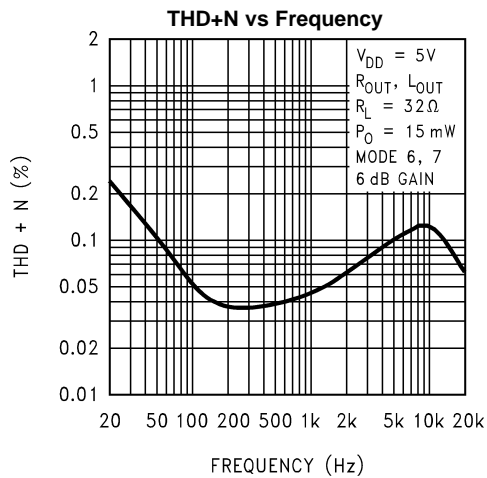

Figure 9.

Typical Performance Characteristics (continued)

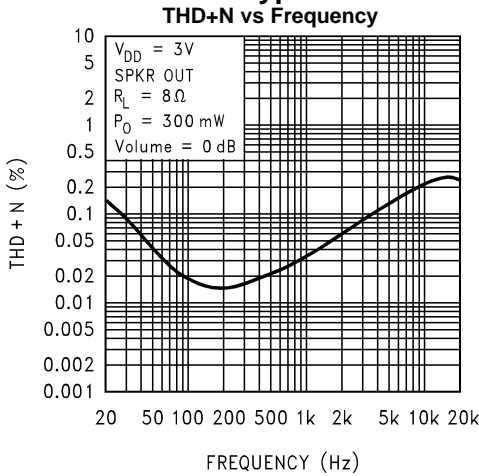

Figure 10.

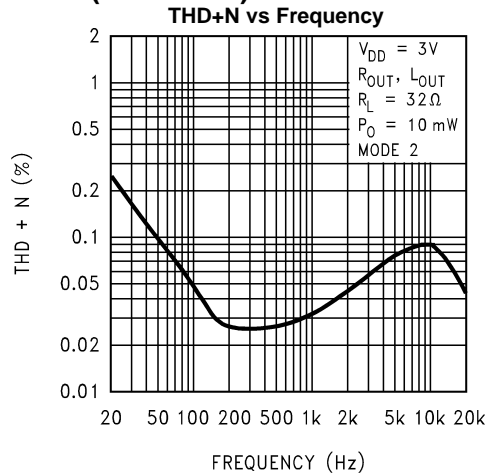

Figure 11.

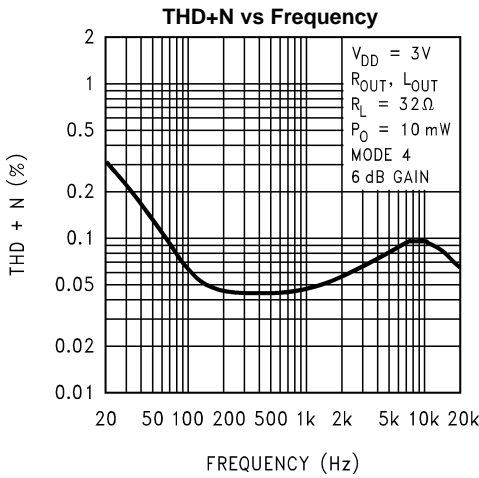

Figure 12.

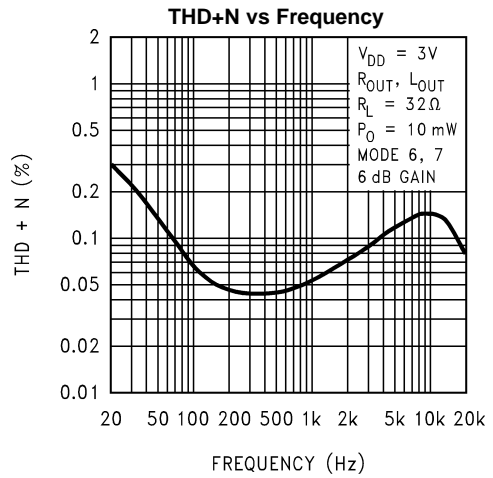

Figure 13.

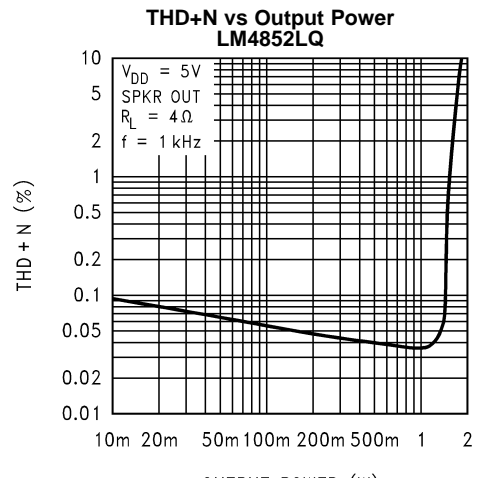

Figure 14.

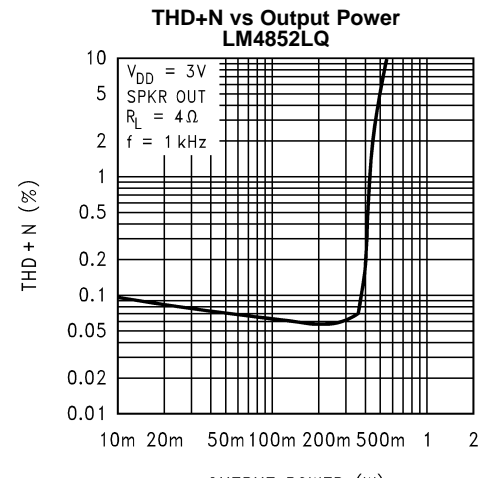

Figure 15.

Typical Performance Characteristics (continued)

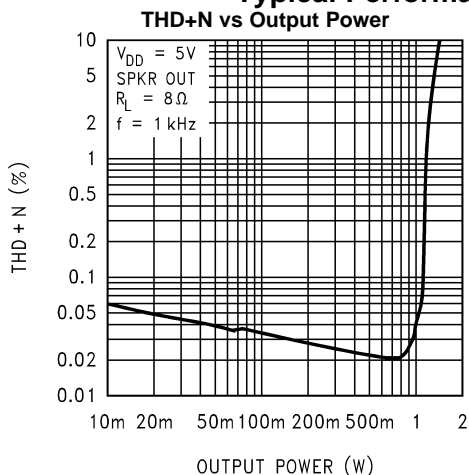

Figure 16.

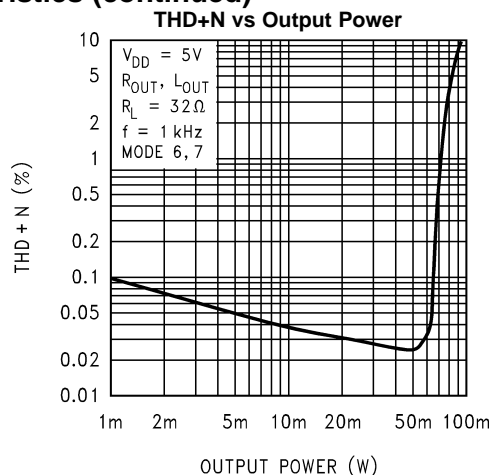

Figure 17.

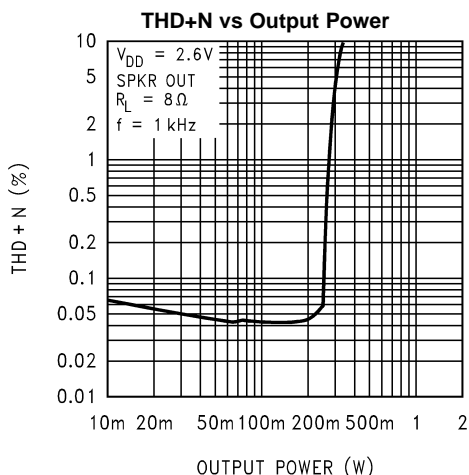

Figure 18.

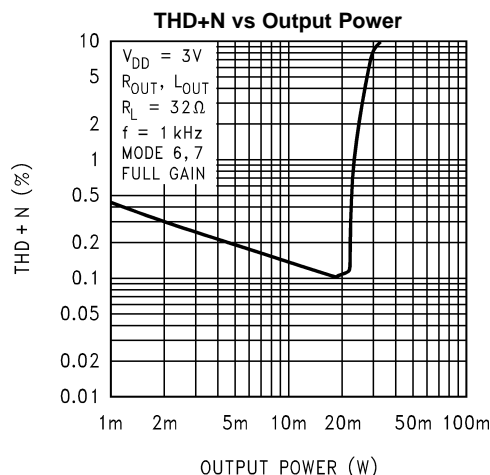

Figure 19.

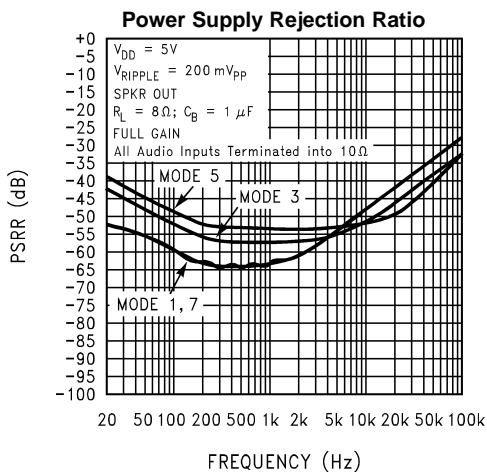

Figure 20.

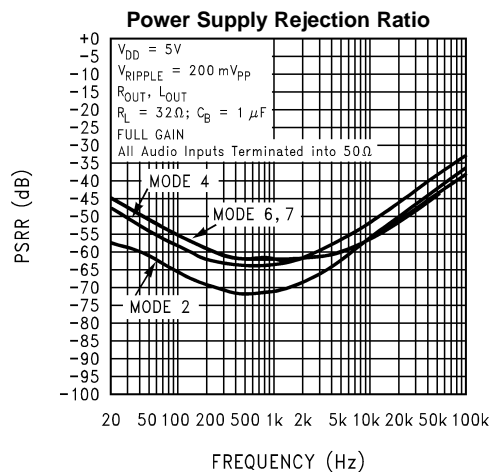

Figure 21.

Typical Performance Characteristics (continued)

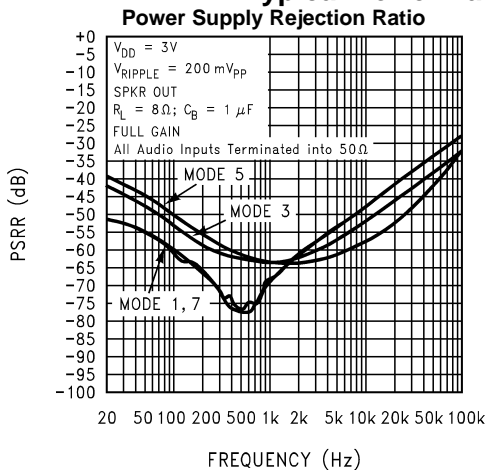

Figure 22.

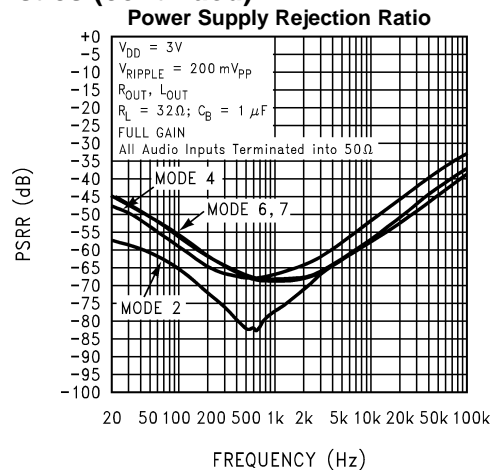

Figure 23.

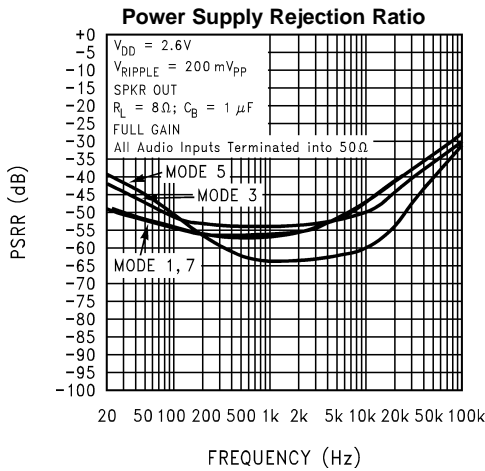

Figure 24.

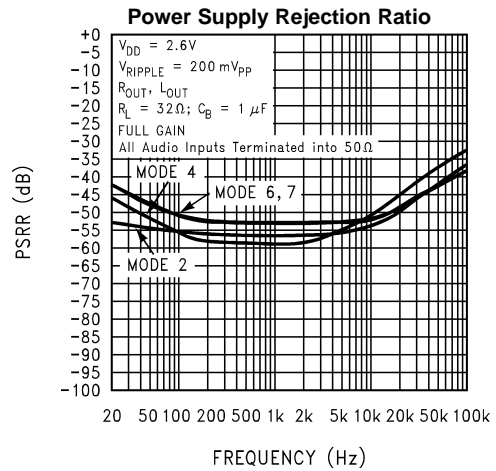

Figure 25.

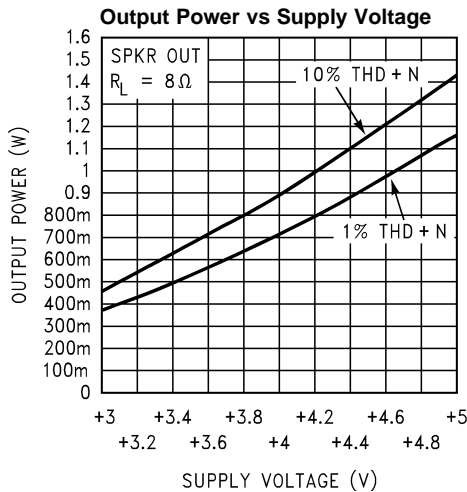

Figure 26.

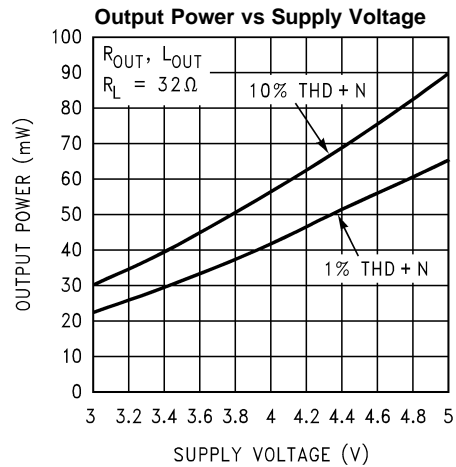

Figure 27.

Typical Performance Characteristics (continued)

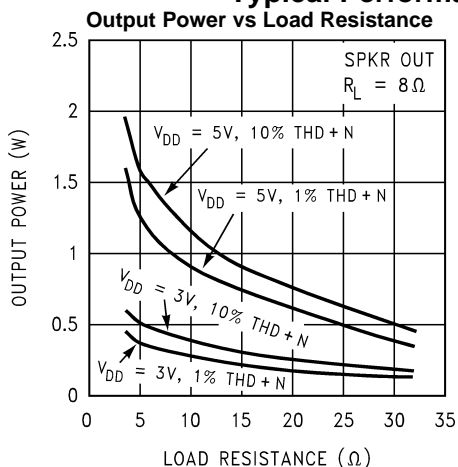

Figure 28.

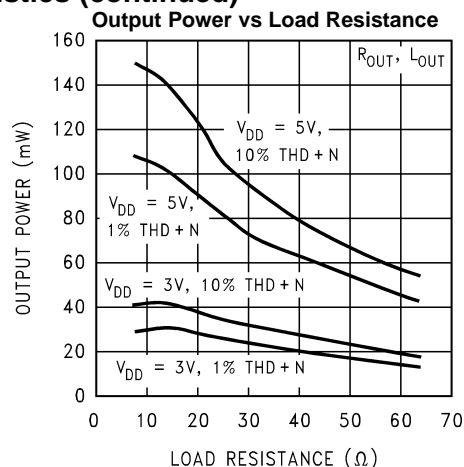

Figure 29.

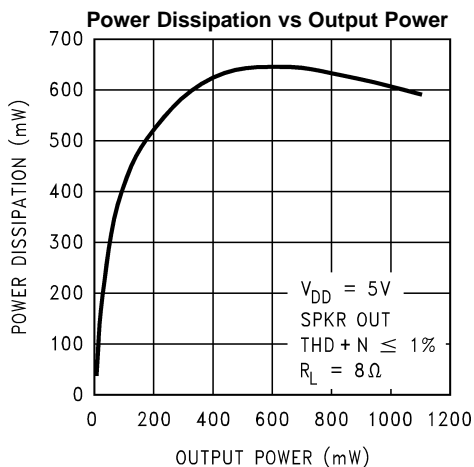

Figure 30.

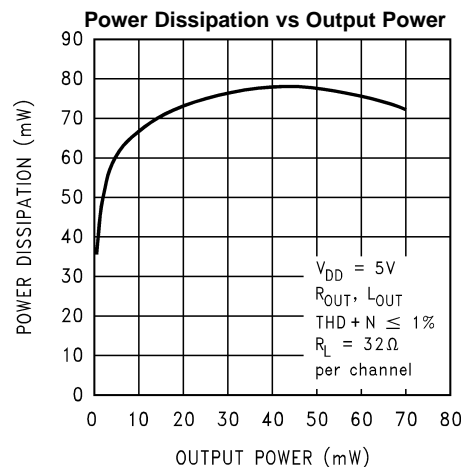

Figure 31.

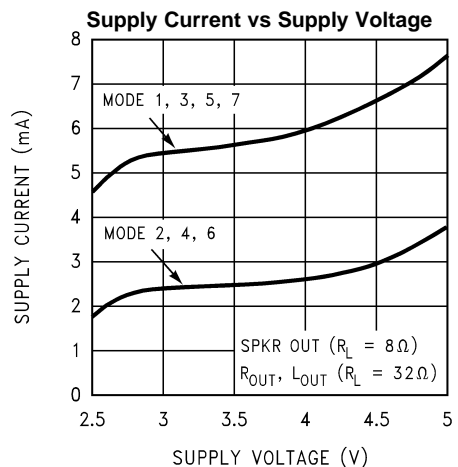

Figure 32.

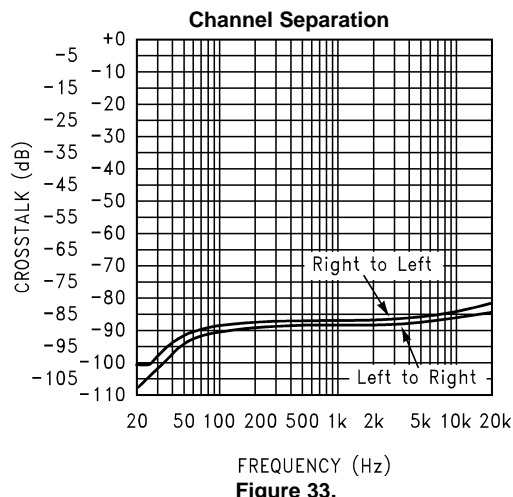

Figure 33.

Typical Performance Characteristics (continued)

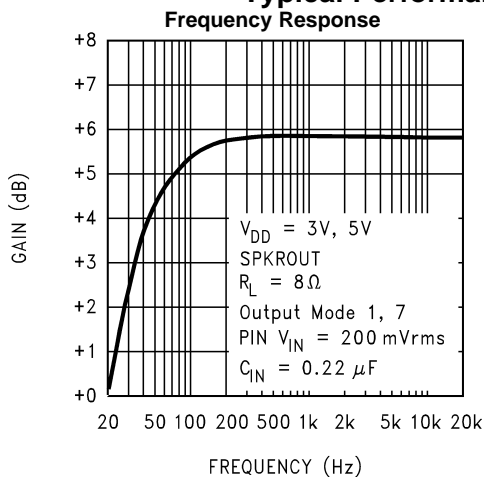

Figure 34.

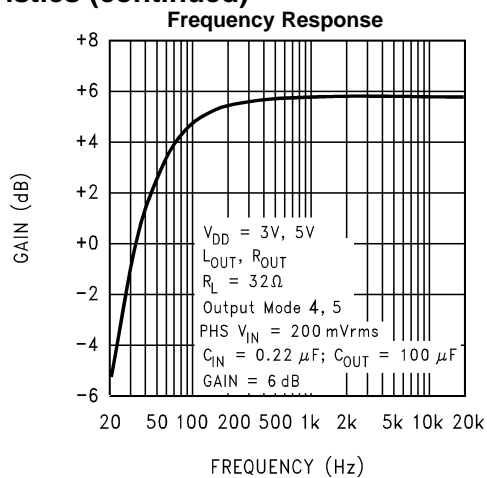

Figure 35.

Table 1. Output Noise vs Output Mode (V_{DD} = 3V, 5V)⁽¹⁾

Output Mode	SPKRROUT Output Noise (μV)	LOUT/ROUT Output Noise (μV)
1	26	X
2	X	15 (G = 6dB)
3	30	15 (G = 6dB)
4	X	20 (G = 6dB)
5	40	20 (G = 6dB)
6	X	25 (G = 6dB)
7	26	25 (G = 6dB)

(1) G = LIN / RIN gain setting
A - weighted filter used

APPLICATION INFORMATION

I²C PIN DESCRIPTION

SDA: This is the serial data input pin.

SCL: This is the clock input pin.

ADR: This is the address select input pin.

I²C INTERFACE

The LM4852 uses a serial bus, which conforms to the I²C protocol, to control the chip's functions with two wires: clock and data. The clock line is uni-directional. The data line is bi-directional (open-collector) with a pullup resistor (typically 10k Ω). The maximum clock frequency specified by the I²C standard is 400kHz. In this discussion, the master is the controlling microcontroller and the slave is the LM4852.

The I²C address for the LM4852 is determined using the ADR pin. The LM4852's two possible I²C chip addresses are of the form 110110X₁0 (binary), where the X₁ = 0, if ADR is logic low; and X₁ = 1, if ADR is logic high. If the I²C interface is used to address a number of chips in a system and the LM4852's chip address can be changed to avoid address conflicts.

The timing diagram for the I²C is shown in Figure 36. The data is latched in on the stable high level of the clock and the data line should be held high when not in use. The timing diagram is broken up into six major sections:

The “start” signal is generated by lowering the data signal while the clock signal is high. The start signal will alert all devices attached to the I²C bus to check the incoming address against their own chip address.

The 8-bit chip address is sent next, most significant bit first. Each address bit must be stable while the clock level is high.

After the last bit of the address is sent, the master checks for the LM4852's acknowledge. The master releases the data line high (through a pullup resistor). Then the master sends a clock pulse. If the LM4852 has received the address correctly, then it holds the data line low during the clock pulse. If the data line is not low, then the master should send a “stop” signal (discussed later) and abort the transfer.

The 8 bits of data are sent next, most significant bit first. Each data bit should be valid while the clock level is stable high.

After the data byte is sent, the master must generate another acknowledge to see if the LM4852 received the data.

If the master has more data bytes to send to the LM4852, then the master can repeat the previous two steps until all data bytes have been sent.

The “stop” signal ends the transfer. To signal “stop”, the data signal goes high while the clock signal is high.

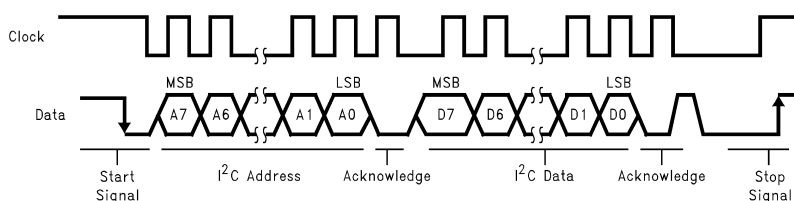

Figure 36. I²C Bus Format

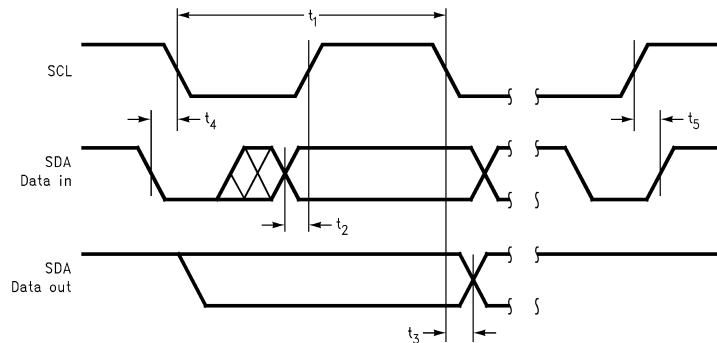

Figure 37. I²C Timing Diagram

Table 2. Data Register

BIT	DATA							
	D7	D6	D5	D4	D3	D2	D1	D0
Function	Volume Control					Output Mode Control		
Name	V4	V3	V2	V1	V0	M2	M1	M0
Default	0	0	0	0	0	0	0	0

Table 3. Output Mode Selection⁽¹⁾

M2	M1	M0	Handsfree Speaker Output	Right Headphone Output	Left Headphone Output	Output Mode Number
0	0	0	SD	SD	SD	0
0	0	1	6dB x P	MUTE	MUTE	1
0	1	0	SD	P	P	2
0	1	1	G (R+L)	MUTE	MUTE	3
1	0	0	SD	G x R	G x L	4
1	0	1	G (R+L) + 6dB x P	MUTE	MUTE	5
1	1	0	SD	(GxR) + P	(G x L) + P	6
1	1	1	6dB x P	(GxR) + P	(G x L) + P	7

- (1) P = Phone In
R = R_{IN}
L = L_{IN}
SD = Shutdown
MUTE = Mute Mode
G = L_{IN} and R_{IN} gain setting

Table 4. Volume Control

V4	V3	V2	V1	V0	Gain (dB)
					G
0	0	0	0	0	-40.5
0	0	0	0	1	-39.0
0	0	0	1	0	-37.5
0	0	0	1	1	-36.0
0	0	1	0	0	-34.5
0	0	1	0	1	-33.0
0	0	1	1	0	-31.5
0	0	1	1	1	-30.0
0	1	0	0	0	-28.5
0	1	0	0	1	-27.0
0	1	0	1	0	-25.5
0	1	0	1	1	-24.0
0	1	1	0	0	-22.5
0	1	1	0	1	-21.0
0	1	1	1	0	-19.5
0	1	1	1	1	-18.0
1	0	0	0	0	-16.5
1	0	0	0	1	-15.0
1	0	0	1	0	-13.5
1	0	0	1	1	-12.0
1	0	1	0	0	-10.5
1	0	1	0	1	-9.0
1	0	1	1	0	-7.5
1	0	1	1	1	-6.0
1	1	0	0	0	-4.5
1	1	0	0	1	-3.0
1	1	0	1	0	-1.5
1	1	0	1	1	0.0
1	1	1	0	0	1.5
1	1	1	0	1	3.0
1	1	1	1	0	4.5
1	1	1	1	1	6.0

EXPOSED-DAP MOUNTING CONSIDERATIONS

The LM4852's exposed-DAP (die attach paddle) package (LD) provides a low thermal resistance between the die and the PCB to which the part is mounted and soldered. This allows rapid heat transfer from the die to the surrounding PCB copper area heatsink, copper traces, ground plane, and finally, surrounding air. The result is a low voltage audio power amplifier that produces 1.1W dissipation in a 8Ω load at ≤ 1% THD+N. This high power is achieved through careful consideration of necessary thermal design. Failing to optimize thermal design may compromise the LM4852's high power performance and activate unwanted, though necessary, thermal shutdown protection.

The LD package must have its DAP soldered to a copper pad on the PCB. The DAP's PCB copper pad is then, ideally, connected to a large plane of continuous unbroken copper. This plane forms a thermal mass, heat sink, and radiation area. Place the heat sink area on either outside plane in the case of a two-sided or multi-layer PCB. (The heat sink area can also be placed on an inner layer of a multi-layer board. The thermal resistance, however, will be higher.) Connect the DAP copper pad to the inner layer or backside copper heat sink area with 6 (3 X 2) (LD) vias. The via diameter should be 0.012in - 0.013in with a 1.27mm pitch. Ensure efficient thermal conductivity by plugging and tenting the vias with plating and solder mask, respectively.

Best thermal performance is achieved with the largest practical copper heat sink area. If the heatsink and amplifier share the same PCB layer, a nominal 2.5in^2 (min) area is necessary for 5V operation with a 4Ω load. Heatsink areas not placed on the same PCB layer as the LM4852 should be 5in^2 (min) for the same supply voltage and load resistance. The last two area recommendations apply for 25°C ambient temperature. Increase the area to compensate for ambient temperatures above 25°C . In all circumstances and under all conditions, the junction temperature must be held below 150°C to prevent activating the LM4852's thermal shutdown protection. Further detailed and specific information concerning PCB layout and fabrication and mounting an LD (WQFN) is found in Texas Instruments AN1187 ([SNOA401](#)).

PCB LAYOUT AND SUPPLY REGULATION CONSIDERATIONS FOR DRIVING 3Ω AND 4Ω LOADS

Power dissipated by a load is a function of the voltage swing across the load and the load's impedance. As load impedance decreases, load dissipation becomes increasingly dependent on the interconnect (PCB trace and wire) resistance between the amplifier output pins and the load's connections. Residual trace resistance causes a voltage drop, which results in power dissipated in the trace and not in the load as desired. For example, 0.1Ω trace resistance reduces the output power dissipated by a 4Ω load from 1.7W to 1.6W . The problem of decreased load dissipation is exacerbated as load impedance decreases. Therefore, to maintain the highest load dissipation and widest output voltage swing, PCB traces that connect the output pins to a load must be as wide as possible.

Poor power supply regulation adversely affects maximum output power. A poorly regulated supply's output voltage decreases with increasing load current. Reduced supply voltage causes decreased headroom, output signal clipping, and reduced output power. Even with tightly regulated supplies, trace resistance creates the same effects as poor supply regulation. Therefore, making the power supply traces as wide as possible helps maintain full output voltage swing.

BRIDGE CONFIGURATION EXPLANATION

As shown in [Figure 1](#), the LM4852 consists of three pairs of output amplifier blocks (A4-A6). Amplifier block A6 consists of a bridged-tied amplifier pair that drives SPKROUT. The LM4852 drives a load, such as a speaker, connected between outputs, SPKROUT+ and SPKROUT-. In the amplifier block A6, the output of the amplifier that drives SPKROUT- serves as the input to the unity gain inverting amplifier that drives SPKROUT+.

This results in both amplifiers producing signals identical in magnitude, but 180° out of phase. Taking advantage of this phase difference, a load is placed between SPKROUT- and SPKROUT+ and driven differentially (commonly referred to as 'bridge mode'). This results in a differential or BTL gain of:

$$A_{VD} = 2(R_f / R_i) = 2 \quad (1)$$

Bridge mode amplifiers are different from single-ended amplifiers that drive loads connected between a single amplifier's output and ground. For a given supply voltage, bridge mode has a distinct advantage over the single-ended configuration: its differential output doubles the voltage swing across the load. Theoretically, this produces four times the output power when compared to a single-ended amplifier under the same conditions. This increase in attainable output power assumes that the amplifier is not current limited and that the output signal is not clipped.

Another advantage of the differential bridge output is no net DC voltage across the load. This is accomplished by biasing SPKROUT- and SPKROUT+ outputs at half-supply. This eliminates the coupling capacitor that single supply, single-ended amplifiers require. Eliminating an output coupling capacitor in a typical single-ended configuration forces a single-supply amplifier's half-supply bias voltage across the load. This increases internal IC power dissipation and may permanently damage loads such as speakers.

POWER DISSIPATION

Power dissipation is a major concern when designing a successful single-ended or bridged amplifier.

A direct consequence of the increased power delivered to the load by a bridge amplifier is higher internal power dissipation. The LM4852 has a pair of bridged-tied amplifiers driving a handsfree speaker, SPKROUT. The maximum internal power dissipation operating in the bridge mode is twice that of a single-ended amplifier. From [Equation 2](#), assuming a 5V power supply and an 8Ω load, the maximum SPKROUT power dissipation is 634mW.

$$P_{\text{DMAX-SPKROUT}} = 4(V_{\text{DD}})^2 / (2\pi^2 R_L): \text{Bridge Mode} \quad (2)$$

The LM4852 also has a pair of single-ended amplifiers driving stereo headphones, ROUT and LOUT. The maximum internal power dissipation for ROUT and LOUT is given by [Equation 3](#) and [Equation 4](#). From [Equation 3](#) and [Equation 4](#), assuming a 5V power supply and a 32Ω load, the maximum power dissipation for LOUT and ROUT is 40mW, or 80mW total.

$$P_{\text{DMAX-LOUT}} = (V_{\text{DD}})^2 / (2\pi^2 R_L): \text{Single-ended Mode} \quad (3)$$

$$P_{\text{DMAX-ROUT}} = (V_{\text{DD}})^2 / (2\pi^2 R_L): \text{Single-ended Mode} \quad (4)$$

The maximum internal power dissipation of the LM4852 occurs when all 3 amplifiers pairs are simultaneously on; and is given by [Equation 5](#).

$$P_{\text{DMAX-TOTAL}} = P_{\text{DMAX-SPKROUT}} + P_{\text{DMAX-LOUT}} + P_{\text{DMAX-ROUT}} \quad (5)$$

The maximum power dissipation point given by [Equation 5](#) must not exceed the power dissipation given by [Equation 6](#):

$$P_{\text{DMAX}'} = (T_{\text{JMAX}} - T_A) / \theta_{\text{JA}} \quad (6)$$

The LM4852's $T_{\text{JMAX}} = 150^\circ\text{C}$. In the ITL package, the LM4852's θ_{JA} is 48°C/W . In the LD package soldered to a DAP pad that expands to a copper area of 2.5in^2 on a PCB, the LM4852's θ_{JA} is 42°C/W . At any given ambient temperature T_A , use [Equation 6](#) to find the maximum internal power dissipation supported by the IC packaging. Rearranging [Equation 6](#) and substituting $P_{\text{DMAX-TOTAL}}$ for $P_{\text{DMAX}'}$ results in [Equation 7](#). This equation gives the maximum ambient temperature that still allows maximum stereo power dissipation without violating the LM4852's maximum junction temperature.

$$T_A = T_{\text{JMAX}} - P_{\text{DMAX-TOTAL}} \theta_{\text{JA}} \quad (7)$$

For a typical application with a 5V power supply and an 8Ω load, the maximum ambient temperature that allows maximum stereo power dissipation without exceeding the maximum junction temperature is approximately 104°C for the IBL package.

$$T_{\text{JMAX}} = P_{\text{DMAX-TOTAL}} \theta_{\text{JA}} + T_A \quad (8)$$

[Equation 8](#) gives the maximum junction temperature T_{JMAX} . If the result violates the LM4852's 150°C , reduce the maximum junction temperature by reducing the power supply voltage or increasing the load resistance. Further allowance should be made for increased ambient temperatures.

The above examples assume that a device is a surface mount part operating around the maximum power dissipation point. Since internal power dissipation is a function of output power, higher ambient temperatures are allowed as output power or duty cycle decreases. If the result of [Equation 5](#) is greater than that of [Equation 6](#), then decrease the supply voltage, increase the load impedance, or reduce the ambient temperature. If these measures are insufficient, a heat sink can be added to reduce θ_{JA} . The heat sink can be created using additional copper area around the package, with connections to the ground pin(s), supply pin and amplifier output pins. External, solder attached SMT heatsinks such as the Thermalloy 7106D can also improve power dissipation. When adding a heat sink, the θ_{JA} is the sum of θ_{JC} , θ_{CS} , and θ_{SA} . (θ_{JC} is the junction-to-case thermal impedance, θ_{CS} is the case-to-sink thermal impedance, and θ_{SA} is the sink-to-ambient thermal impedance.) Refer to the [Typical Performance Characteristics](#) curves for power dissipation information at lower output power levels.

POWER SUPPLY BYPASSING

As with any power amplifier, proper supply bypassing is critical for low noise performance and high power supply rejection. Applications that employ a 5V regulator typically use a 10 μ F in parallel with a 0.1 μ F filter capacitors to stabilize the regulator's output, reduce noise on the supply line, and improve the supply's transient response. However, their presence does not eliminate the need for a local 1.0 μ F tantalum bypass capacitance connected between the LM4852's supply pins and ground. Keep the length of leads and traces that connect capacitors between the LM4852's power supply pin and ground as short as possible. Connecting a 1 μ F capacitor, C_B , between the BYPASS pin and ground improves the internal bias voltage's stability and improves the amplifier's PSRR. The PSRR improvements increase as the bypass pin capacitor value increases. Too large, however, increases turn-on time and can compromise the amplifier's click and pop performance. The selection of bypass capacitor values, especially C_B , depends on desired PSRR requirements, click and pop performance (as explained in the section, Proper Selection of External Components), system cost, and size constraints.

SELECTING EXTERNAL COMPONENTS

Input Capacitor Value Selection

Amplifying the lowest audio frequencies requires high value input coupling capacitor (C_i in [Figure 37](#)). A high value capacitor can be expensive and may compromise space efficiency in portable designs. In many cases, however, the speakers used in portable systems, whether internal or external, have little ability to reproduce signals below 150Hz. Applications using speakers with this limited frequency response reap little improvement by using large input capacitor.

The internal input resistor (R_i) and the input capacitor (C_i) produce a high pass filter cutoff frequency that is found using [Equation 9](#).

$$f_c = 1 / (2\pi R_i C_i) \quad (9)$$

As an example when using a speaker with a low frequency limit of 150Hz, C_i , using [Equation 9](#) is 0.063 μ F. The 0.22 μ F C_i shown in [Figure 1](#) allows the LM4852 to drive high efficiency, full range speaker whose response extends below 40Hz.

Bypass Capacitor Value Selection

Besides minimizing the input capacitor size, careful consideration should be paid to value of C_B , the capacitor connected to the BYPASS pin. Since C_B determines how fast the LM4852 settles to quiescent operation, its value is critical when minimizing turn-on pops. The slower the LM4852's outputs ramp to their quiescent DC voltage (nominally $V_{DD}/2$), the smaller the turn-on pop. Choosing C_B equal to 1.0 μ F along with a small value of C_i (in the range of 0.1 μ F to 0.39 μ F), produces a click-less and pop-less shutdown function. As discussed above, choosing C_i no larger than necessary for the desired bandwidth helps minimize clicks and pops. C_B 's value should be in the range of 5 times to 7 times the value of C_i . This ensures that output transients are eliminated when power is first applied or the LM4852 resumes operation after shutdown.

Demonstration ITL Board Layout

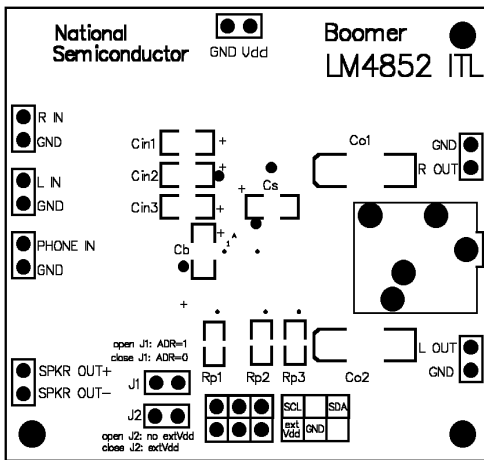

Figure 38. Recommended ITL PC Board Layout: Top Overlay Layer

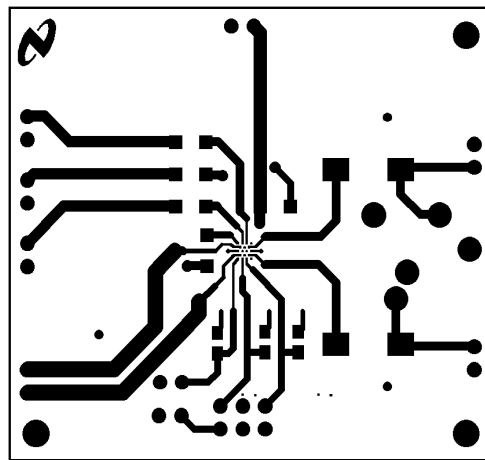

Figure 39. Recommended ITL PC Board Layout: Top Layer

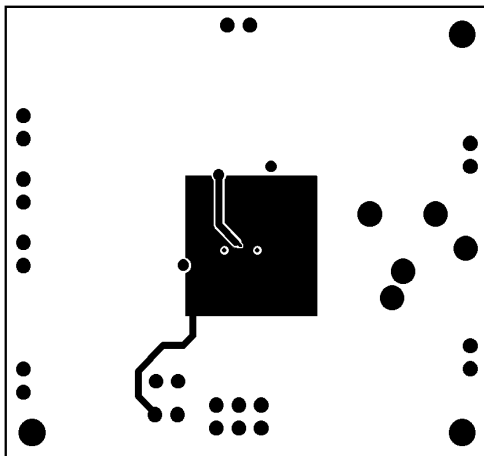

Figure 40. Recommended ITL PC Board Layout: Middle 1 Layer

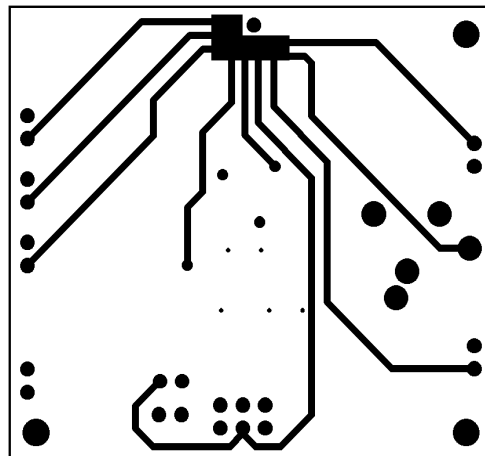

Figure 41. Recommended ITL PC Board Layout: Middle 2 Layer

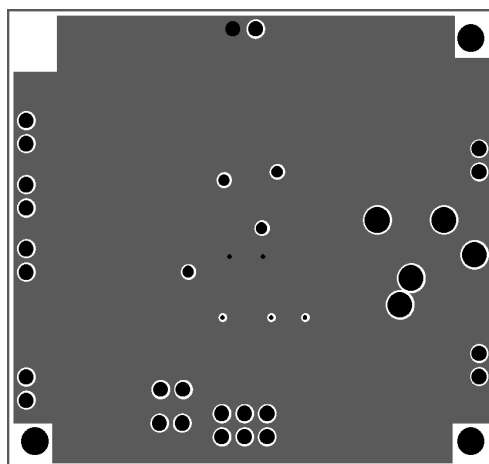

Figure 42. Recommended ITL PC Board Layout: Bottom Layer

Demonstration LQ Board Layout

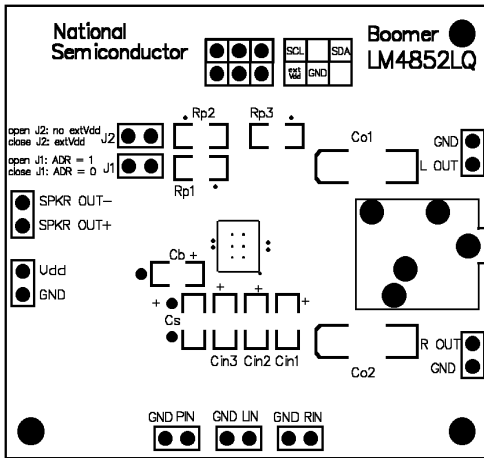

Figure 43. Recommended LQ PC Board Layout: Top Overlay Layer

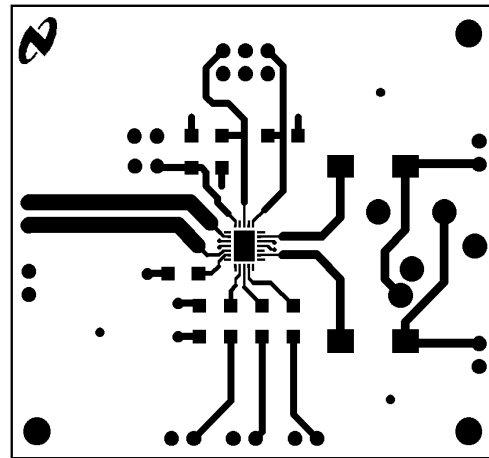

Figure 44. Recommended LQ PC Board Layout: Top Layer

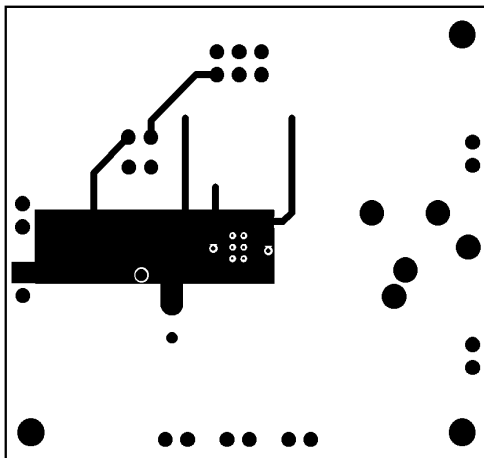

Figure 45. Recommended LQ PC Board Layout: Middle 1 Layer

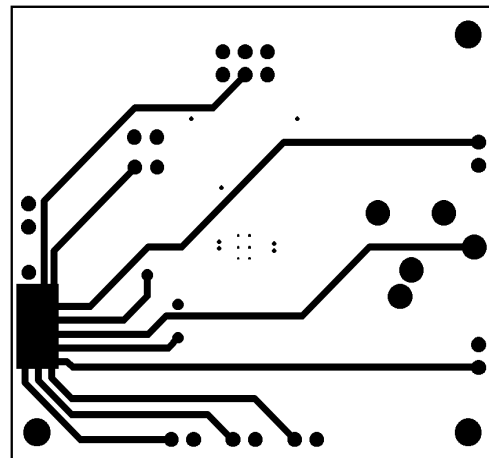

Figure 46. Recommended LQ PC Board Layout: Middle 2 Layer

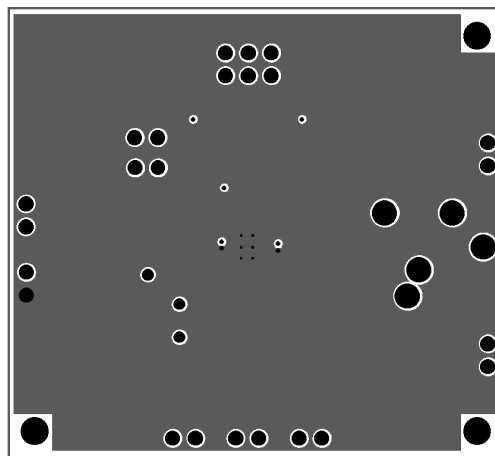

Figure 47. Recommended LQ PC Board Layout: Bottom Layer

IMPORTANT NOTICE

Texas Instruments Incorporated and its subsidiaries (TI) reserve the right to make corrections, enhancements, improvements and other changes to its semiconductor products and services per JESD46, latest issue, and to discontinue any product or service per JESD48, latest issue. Buyers should obtain the latest relevant information before placing orders and should verify that such information is current and complete. All semiconductor products (also referred to herein as "components") are sold subject to TI's terms and conditions of sale supplied at the time of order acknowledgment.

TI warrants performance of its components to the specifications applicable at the time of sale, in accordance with the warranty in TI's terms and conditions of sale of semiconductor products. Testing and other quality control techniques are used to the extent TI deems necessary to support this warranty. Except where mandated by applicable law, testing of all parameters of each component is not necessarily performed.

TI assumes no liability for applications assistance or the design of Buyers' products. Buyers are responsible for their products and applications using TI components. To minimize the risks associated with Buyers' products and applications, Buyers should provide adequate design and operating safeguards.

TI does not warrant or represent that any license, either express or implied, is granted under any patent right, copyright, mask work right, or other intellectual property right relating to any combination, machine, or process in which TI components or services are used. Information published by TI regarding third-party products or services does not constitute a license to use such products or services or a warranty or endorsement thereof. Use of such information may require a license from a third party under the patents or other intellectual property of the third party, or a license from TI under the patents or other intellectual property of TI.

Reproduction of significant portions of TI information in TI data books or data sheets is permissible only if reproduction is without alteration and is accompanied by all associated warranties, conditions, limitations, and notices. TI is not responsible or liable for such altered documentation. Information of third parties may be subject to additional restrictions.

Resale of TI components or services with statements different from or beyond the parameters stated by TI for that component or service voids all express and any implied warranties for the associated TI component or service and is an unfair and deceptive business practice. TI is not responsible or liable for any such statements.

Buyer acknowledges and agrees that it is solely responsible for compliance with all legal, regulatory and safety-related requirements concerning its products, and any use of TI components in its applications, notwithstanding any applications-related information or support that may be provided by TI. Buyer represents and agrees that it has all the necessary expertise to create and implement safeguards which anticipate dangerous consequences of failures, monitor failures and their consequences, lessen the likelihood of failures that might cause harm and take appropriate remedial actions. Buyer will fully indemnify TI and its representatives against any damages arising out of the use of any TI components in safety-critical applications.

In some cases, TI components may be promoted specifically to facilitate safety-related applications. With such components, TI's goal is to help enable customers to design and create their own end-product solutions that meet applicable functional safety standards and requirements. Nonetheless, such components are subject to these terms.

No TI components are authorized for use in FDA Class III (or similar life-critical medical equipment) unless authorized officers of the parties have executed a special agreement specifically governing such use.

Only those TI components which TI has specifically designated as military grade or "enhanced plastic" are designed and intended for use in military/aerospace applications or environments. Buyer acknowledges and agrees that any military or aerospace use of TI components which have **not** been so designated is solely at the Buyer's risk, and that Buyer is solely responsible for compliance with all legal and regulatory requirements in connection with such use.

TI has specifically designated certain components as meeting ISO/TS16949 requirements, mainly for automotive use. In any case of use of non-designated products, TI will not be responsible for any failure to meet ISO/TS16949.

Products

Audio	www.ti.com/audio
Amplifiers	amplifier.ti.com
Data Converters	dataconverter.ti.com
DLP® Products	www.dlp.com
DSP	dsp.ti.com
Clocks and Timers	www.ti.com/clocks
Interface	interface.ti.com
Logic	logic.ti.com
Power Mgmt	power.ti.com
Microcontrollers	microcontroller.ti.com
RFID	www.ti-rfid.com
OMAP Applications Processors	www.ti.com/omap
Wireless Connectivity	www.ti.com/wirelessconnectivity

Applications



Automotive and Transportation	www.ti.com/automotive
Communications and Telecom	www.ti.com/communications
Computers and Peripherals	www.ti.com/computers
Consumer Electronics	www.ti.com/consumer-apps
Energy and Lighting	www.ti.com/energy
Industrial	www.ti.com/industrial
Medical	www.ti.com/medical
Security	www.ti.com/security
Space, Avionics and Defense	www.ti.com/space-avionics-defense
Video and Imaging	www.ti.com/video

TI E2E Community

e2e.ti.com

Looking for pricing, stock, or lifecycle information?

Click below to explore more details on WIN SOURCE:

-  [View LM4852ITLX/NOPB on WIN SOURCE](#)
-  [Texas Instruments](#) Information

Optimize Your Supply Chain with WIN SOURCE Solutions

-  Global Sourcing Solution
-  Obsolete Management
-  Cost Control Management
-  Shortage Management
-  Alternative Solution
-  Excess Inventory Management