



**THE DATASHEET OF
KSS241GLFS**



KSS Series Subminiature SMT Side Actuated

Features/Benefits

- Low profile of 1.7 mm
- Excellent tactile feel
- High shear force
- Range of actuation forces
- Large flat top
- RoHS compliant and compatible

Typical Applications

- Cellular phone
- Industrial electronics
- Health diagnostic electronics

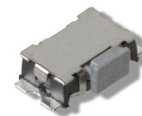

Specification

FUNCTION: momentary action
CONTACT ARRANGEMENT: N.O.
TERMINALS: Gullwing
IP40 sealed

Mechanical

OVERLOAD: 20N
TACTILE FEELING: 2 and 4N: 25% min.
2.5N: 30% min.

Type	Operating force Newtons (grams)	Operating life (operations)	Travel (mm)
KSS221G	2.0 (200) ± 0.5	100,000	0,3 ± 0,15
KSS231G	2.5 (250) ± 0.5	100,000	0,3 ± 0,10
KSS241G	4.0 (400) ± 1.0	100,000	0,3 ± 0,15

NOTE: Specifications listed above are for switches with standard options.
For information on specific and custom switches, consult Customer Service Center.

Electrical

	Silver	Gold
MAXIMUM POWER:	1 VA	0.2 VA
MAXIMUM VOLTAGE:	32 VDC	32 VDC
MAXIMUM CURRENT:	50 mA	10 mA
MINIMUM CURRENT:	1 mA	1 mA
DIELECTRIC STRENGTH:	≥ 250 VDC	
CONTACT RESISTANCE:	< 100 mΩ	
INSULATION RESISTANCE (100 VDC):	≥ 10 ⁹ Ω	
BOUNCE TIME:	< 3 ms	

Environmental

	Silver	Gold
OPERATING TEMPERATURE:	-40°C to 85°C	-40°C to 125°C
STORAGE TEMPERATURE:	-55°C to 85°C	-55°C to 125°C

Process

Soldering: Lead free reflow soldering process in accordance with IEC 61760-1.

Packaging

Tape and reels in reels of 3,000 pieces.
External diameter 330mm ± 2mm.

How To Order

Our easy build-a-switch concept allows you to mix and match options to create the switch you need. To order, select desired option from each category and place it in the appropriate box.

However, please note that all the combinations of these options are not feasible.

For any part number different from those listed above, please consult your local representative.

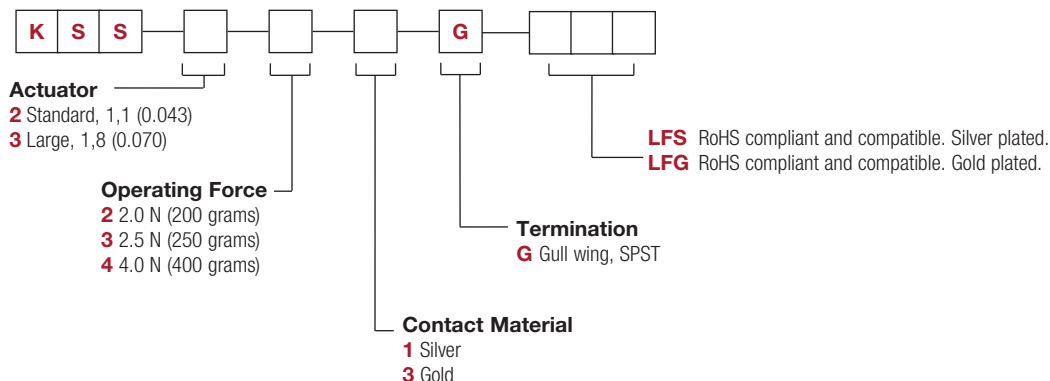

KSS Series Subminiature SMT Side Actuated

KSS

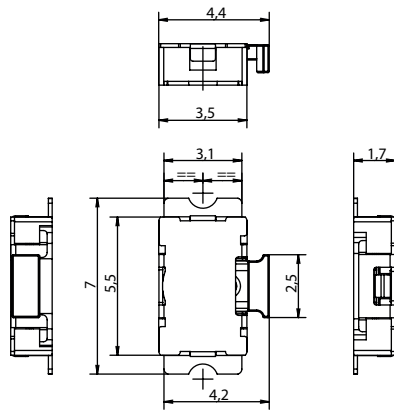

PCB PROPOSED LAYOUT

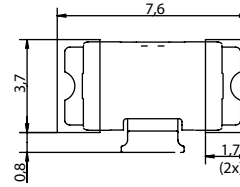

Tactile Switches

B

ACTUATOR

2 STANDARD, 1,1 (0.043)

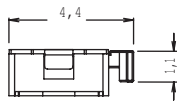

3 LARGE, 1,8 (0.070)

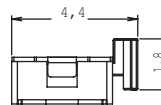

TAPE & REEL

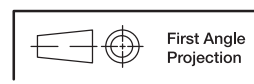
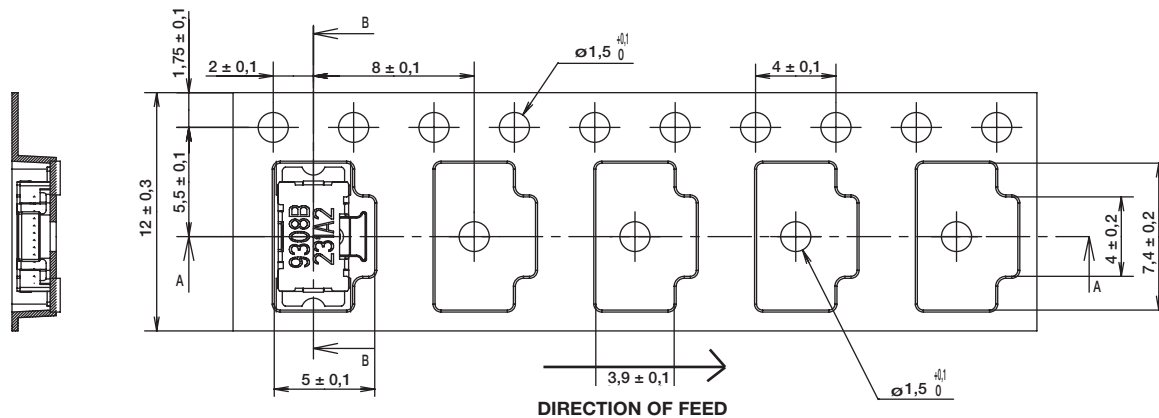

First Angle
Projection

Dimensions are shown: mm
Specifications and dimensions subject to change

Looking for pricing, stock, or lifecycle information?

Click below to explore more details on WIN SOURCE:

- ⊖ [View KSS241GLFS](#) on WIN SOURCE
- ⊖ [C&K Components](#) Information

Optimize Your Supply Chain with WIN SOURCE Solutions

- ✓ Global Sourcing Solution
- ✓ Obsolete Management
- ✓ Cost Control Management
- ✓ Shortage Management
- ✓ Alternative Solution
- ✓ Excess Inventory Management