

AEROFLEX
METELICS

A
COBHAM
Company

**Hi-Rel Components
from Aeroflex / Metelics**

Diodes

Switching

Zener

TC Zener

Current Regulators

Transistors

Small Signal

Medium & High Power

Darlington

Silicon Controlled Rectifiers

JANHC and JANKC Chips

DLA Certified JAN–JANS

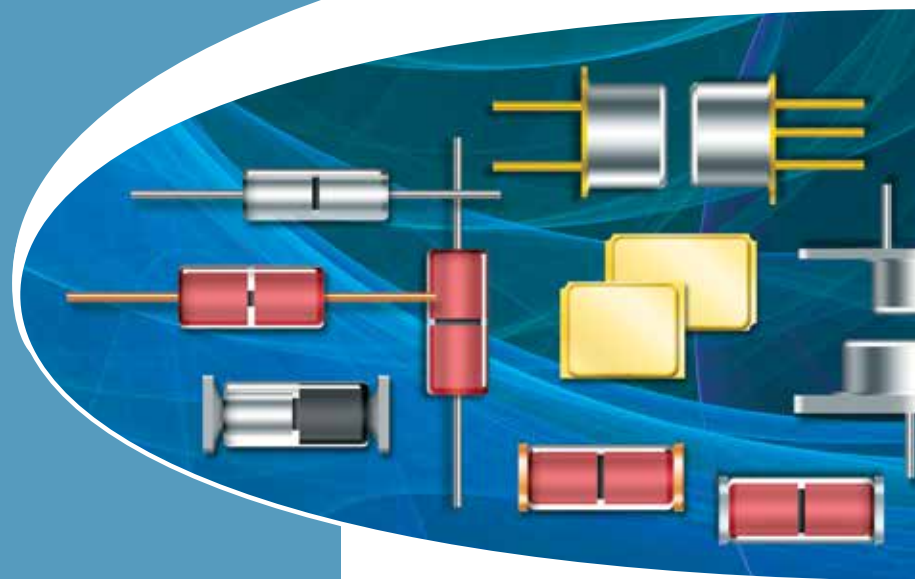

Short Form Catalog
October 2014

Diodes for HiRel Applications

Zener Diodes

Available in JAN, JANTX and JANTXV levels to MIL-PRF-19500 slash sheets /117, /127, and /437 and JAN, JANTX, JANTXV and JANS levels for /435 in both axial leaded and MELF packages.

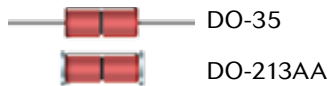

Zener Diodes 1N4099-1 to 1N4135-1, 1N4614-1 to 1N4627-1 <i>aeroflex.com/MetelicsHRC</i>	Nominal Zener Voltage, V_Z (Note 2)	Zener Test Current, I_{ZT}	Maximum Zener Impedance, Z_T (Note 3)	Maximum Reverse Current, I_R @ V_R	Maximum Noise Density, N_b @ I_{ZT}	Maximum Zener DC Current, I_{ZM}
	Volts	μA	Ohms	μA Volts	$\mu V / \sqrt{Hz}$	mA
Types (Note 1)						
1N4614-1, 1N4614UR-1	1.8	250	1200	7.5 1	1	120
1N4615-1, 1N4615UR-1	2.0	250	1250	5.0 1	1	110
1N4616-1, 1N4616UR-1	2.2	250	1300	4.0 1	1	100
1N4617-1, 1N4617UR-1	2.4	250	1400	2.0 1	1	95
1N4618-1, 1N4618UR-1	2.7	250	1500	1.0 1	1	90
1N4619-1, 1N4619UR-1	3.0	250	1600	0.8 1	1	87
1N4620-1, 1N4620UR-1	3.3	250	1650	7.5 1.5	1	85
1N4621-1, 1N4621UR-1	3.6	250	1700	7.5 2	1	83
1N4622-1, 1N4622UR-1	3.9	250	1650	5.0 2	1	80
1N4623-1, 1N4623UR-1	4.3	250	1600	4.0 2	1	77
1N4624-1, 1N4624UR-1	4.7	250	1550	10.0 2	1	75
1N4625-1, 1N4625UR-1	5.1	250	1500	10.0 3	2	70
1N4626-1, 1N4626UR-1	5.6	250	1400	10.0 4	4	65
1N4627-1, 1N4627UR-1	6.2	250	1200	10.0 5	5	61
1N4099-1, 1N4099UR-1	6.8	250	200	10.0 5.17	40	56
1N4100-1, 1N4100UR-1	7.5	250	200	10.0 5.70	40	51
1N4101-1, 1N4101UR-1	8.2	250	200	1.0 6.24	40	46
1N4102-1, 1N4102UR-1	8.7	250	200	1.0 6.61	40	44
1N4103-1, 1N4103UR-1	9.1	250	200	1.0 6.92	40	42
1N4104-1, 1N4104UR-1	10	250	200	1.0 7.60	40	38
1N4105-1, 1N4105UR-1	11	250	200	0.05 8.44	40	35
1N4106-1, 1N4106UR-1	12	250	200	0.05 8.12	40	32
1N4107-1, 1N4107UR-1	13	250	200	0.05 9.857	40	29
1N4108-1, 1N4108UR-1	14	250	200	0.05 10.65	40	27
1N4109-1, 1N4109UR-1	15	250	100	0.05 11.40	40	25
1N4110-1, 1N4110UR-1	16	250	100	0.05 12.15	40	24
1N4111-1, 1N4111UR-1	17	250	100	0.05 12.92	40	22
1N4112-1, 1N4112UR-1	18	250	100	0.05 13.67	40	21
1N4113-1, 1N4113UR-1	19	250	150	0.05 14.44	40	20
1N4114-1, 1N4114UR-1	20	250	150	0.01 15.20	40	19
1N4115-1, 1N4115UR-1	22	250	150	0.01 16.72	40	17
1N4116-1, 1N4116UR-1	24	250	150	0.01 18.25	40	16
1N4117-1, 1N4117UR-1	25	250	150	0.01 19.00	40	15
1N4118-1, 1N4118UR-1	27	250	150	0.01 20.45	40	14
1N4119-1, 1N4119UR-1	29	250	200	0.01 21.28	40	14
1N4120-1, 1N4120UR-1	30	250	200	0.01 22.80	40	13
1N4121-1, 1N4121UR-1	33	250	200	0.01 25.08	40	12
1N4122-1, 1N4122UR-1	36	250	200	0.01 27.38	40	11
1N4123-1, 1N4123UR-1	39	250	200	0.01 29.65	40	9.8
1N4124-1, 1N4124UR-1	43	250	250	0.01 32.65	40	8.9
1N4125-1, 1N4125UR-1	47	250	250	0.01 35.75	40	8.1
1N4126-1, 1N4126UR-1	51	250	300	0.01 38.76	40	7.5
1N4127-1, 1N4127UR-1	56	250	300	0.01 42.60	40	6.7
1N4128-1, 1N4128UR-1	60	250	400	0.01 45.60	40	6.4
1N4129-1, 1N4129UR-1	62	250	500	0.01 47.10	40	6.1
1N4130-1, 1N4130UR-1	68	250	700	0.01 51.68	40	5.6
1N4131-1, 1N4131UR-1	75	250	700	0.01 57.00	40	5.1
1N4132-1, 1N4132UR-1	82	250	800	0.01 62.32	40	4.6
1N4133-1, 1N4133UR-1	87	250	1000	0.01 66.12	40	4.4
1N4134-1, 1N4134UR-1	91	250	1200	0.01 69.16	40	4.2
1N4135-1, 1N4135UR-1	100	250	1500	0.01 76.00	40	3.0

Electrical specifications @ $T_A = +25^\circ C$ (unless otherwise specified).

NOTE 1: The JEDEC type numbers shown have a $\pm 5\%$ tolerance on nominal Zener Voltage. The suffix C is used to identify $\pm 2\%$; and suffix D is used to identify $\pm 1\%$.

NOTE 2: Zener voltage is measured with the device junction in thermal equilibrium at an ambient temperature of $25^\circ C \pm 3^\circ C$.

NOTE 3: Zener impedance is derived by superimposing on I_{ZT} A 60 Hz rms a.c. current equal to 10% of I_{ZT} .

Diodes for HiRel Applications



DO-35



DO-213AA

Low Noise Zener Diodes 1N5518B-1 to 1N5546B-1

aeroflex.com/MetelicsHRC

Types (Note 1)	Nominal Zener Voltage, V_Z @ I_{ZT} (Note 2)	Zener Test Current I_{ZT}	Maximum Zener Impedance B, C, D Suffix Z_{ZT} @ I_{ZT} (Note 3)	Maximum Reverse Current, I_R $V_R = \text{Volts}$	B, C, D Suffix Maximum Zener DC Current, I_{ZM}	B, C, D Suffix Maximum Noise Density, @ $I_{ZT} = 250 \text{ mA ND}$	Regulation Factor, ΔV_Z	Low V_Z Current, I_{ZL}		
	Volts	mA	Ohms	$\mu\text{A dc}$	NON & A- Suffix	B- C- D- Suffix	mA dc	$\mu\text{V} / \sqrt{\text{Hz}}$	Volts	mA dc
1N5518B-1, 1N5518BUR-1	3.3	20	26	5.0	0.90	1.0	115	0.5	0.90	2.0
1N5519B-1, 1N5519BUR-1	3.6	20	24	3.0	0.90	1.0	105	0.5	0.90	2.0
1N5520B-1, 1N5520BUR-1	3.9	20	22	1.0	0.90	1.0	98	0.5	0.85	2.0
1N5521B-1, 1N5521BUR-1	4.3	20	18	3.0	1.0	1.5	88	0.5	0.75	2.0
1N5522B-1, 1N5522BUR-1	4.7	10	22	2.0	1.5	2.0	81	0.5	0.60	1.0
1N5523B-1, 1N5523BUR-1	5.1	5.0	26	2.0	2.0	2.5	75	0.5	0.65	0.25
1N5524B-1, 1N5524BUR-1	5.6	3.0	30	2.0	3.0	3.5	68	1.0	0.30	0.25
1N5525B-1, 1N5525BUR-1	6.2	1.0	30	1.0	4.5	5.0	61	1.0	0.20	0.01
1N5526B-1, 1N5526BUR-1	6.8	1.0	30	1.0	5.5	6.2	56	1.0	0.10	0.01
1N5527B-1, 1N5527BUR-1	7.5	1.0	35	0.5	6.0	6.8	51	2.0	0.05	0.01
1N5528B-1, 1N5528BUR-1	8.2	1.0	40	0.5	6.5	7.5	46	4.0	0.05	0.01
1N5529B-1, 1N5529BUR-1	9.1	1.0	45	0.1	7.0	8.2	42	4.0	0.05	0.01
1N5530B-1, 1N5530BUR-1	10.0	1.0	60	0.05	8.0	9.1	38	4.0	0.10	0.01
1N5531B-1, 1N5531BUR-1	11.0	1.0	80	0.05	9.0	9.9	35	5.0	0.20	0.01
1N5532B-1, 1N5532BUR-1	12.0	1.0	90	0.05	9.5	0.8	32	10	0.20	0.01
1N5533B-1, 1N5533BUR-1	13.0	1.0	90	0.01	10.5	11.7	29	15	0.20	0.01
1N5534B-1, 1N5534BUR-1	14.0	1.0	100	0.01	11.5	12.6	27	20	0.20	0.01
1N5535B-1, 1N5535BUR-1	15.0	1.0	100	0.01	12.5	13.5	25	20	0.20	0.01
1N5536B-1, 1N5536BUR-1	16.0	1.0	100	0.01	13.0	14.4	24	20	0.20	0.01
1N5537B-1, 1N5537BUR-1	17.0	1.0	100	0.01	14.0	15.3	22	20	0.20	0.01
1N5538B-1, 1N5538BUR-1	18.0	1.0	100	0.01	15.0	16.2	21	20	0.20	0.01
1N5539B-1, 1N5539BUR-1	19.0	1.0	100	0.01	16.0	17.1	20	20	0.20	0.01
1N5540B-1, 1N5540BUR-1	20.0	1.0	100	0.01	17.0	18.0	19	20	0.20	0.01
1N5541B-1, 1N5541BUR-1	22.0	1.0	100	0.01	18.0	19.8	17	20	0.25	0.01
1N5542B-1, 1N5542BUR-1	24.0	1.0	100	0.01	20.0	21.6	16	20	0.30	0.01
1N5543B-1, 1N5543BUR-1	25.0	1.0	100	0.01	21.0	22.4	15	20	0.35	0.01
1N5544B-1, 1N5544BUR-1	28.0	1.0	100	0.01	23.0	25.2	14	20	0.40	0.01
1N5545B-1, 1N5545BUR-1	30.0	1.0	100	0.01	24.0	27.0	13	20	0.45	0.01
1N5546B-1, 1N5546BUR-1	33.0	1.0	100	0.01	28.0	29.7	12	20	0.50	0.01

Electrical specifications @ $T_A = +25^\circ\text{C}$ (unless otherwise specified).

NOTE 1: No Suffix type numbers are $\pm 20\%$ with guaranteed limits for only V_Z , I_R , and V_F . Units with "A" suffix are $\pm 10\%$ with guaranteed limits for V_Z , I_R , and V_F . Units with guaranteed limits for all six parameters are indicated by a "B" suffix for $\pm 5.0\%$ units, "C" suffix for $\pm 2.0\%$ and "D" suffix for $\pm 1.0\%$.

NOTE 2: Zener voltage is measured with the device junction in thermal equilibrium at an ambient temperature of $25^\circ\text{C} \pm 3^\circ\text{C}$.

NOTE 3: Zener impedance is derived by superimposing on I_{ZT} A 60 Hz rms a.c. current equal to 10% of I_{ZT} .



DO-35



DO-213AA

Zener Diodes 1N746A-1N759, 1N4370A-1N4372A

aeroflex.com/MetelicsHRC

Types (Note 1)	Nominal Zener Voltage, V_Z @ I_{ZT} (Note 2)	Zener Test Current I_{ZT} (Note 2)	Maximum Zener Impedance Z_{ZT} @ I_{ZT} (Note 3)	Maximum Reverse Current, I_R @ V_R	Maximum Zener Current, I_{ZM}
	Volts	mA	Ohms (Ω)	μA	Volts
1N4370A-1, 1N4370AUR-1	2.4	20	30	100	155
1N4371A-1, 1N4371AUR-1	2.7	20	30	60	140
1N4372A-1, 1N4372AUR-1	3.0	20	29	30	125
1N746A-1, 1N746AUR-1	3.3	20	28	5	120
1N747A-1, 1N747AUR-1	3.6	20	24	3	110
1N748A-1, 1N748AUR-1	3.9	20	23	2	100
1N749A-1, 1N749AUR-1	4.3	20	22	2	90
1N750A-1, 1N750AUR-1	4.7	20	19	5	85
1N751A-1, 1N751AUR-1	5.1	20	17	5	75
1N752A-1, 1N752AUR-1	5.6	20	11	5	70
1N753A-1, 1N753AUR-1	6.2	20	7	5	65
1N754A-1, 1N754AUR-1	6.8	20	5	2	60
1N755A-1, 1N755AUR-1	7.5	20	6	2	55
1N756A-1, 1N756AUR-1	8.2	20	8	1	50
1N757A-1, 1N757AUR-1	9.1	20	10	1	45
1N758A-1, 1N758AUR-1	10.0	20	17	1	40
1N759A-1, 1N759AUR-1	12.0	20	30	1	35

Electrical specifications @ $T_A = +25^\circ\text{C}$ (unless otherwise specified).

NOTE 1: Zener voltage tolerance on "A" suffix is $\pm 5\%$. No Suffix denotes $\pm 10\%$ tolerance, "C" suffix denotes $\pm 2\%$ tolerance and "D" suffix denotes $\pm 1\%$ tolerance.

NOTE 2: Zener voltage is measured with the device junction in thermal equilibrium at an ambient temperature of $25^\circ\text{C} \pm 3^\circ\text{C}$.

NOTE 3: Zener impedance is derived by superimposing on I_{ZT} A 60 Hz rms a.c. current equal to 10% of I_{ZT} .

Diodes for HiRel Applications

Silicon Zener Diodes

1N957B-1 thru 1N986B-1. 1N962B-1 thru 1N986B-1 available in JAN, JANTX and JANTXV per MIL-PRF-19500/117

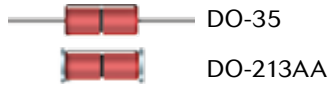

Zener Diodes
1N957B-1 to
1N986B-1
aeroflex.com/MetelicsHRC

Types (Note 1)	Nominal Zener Voltage, V_Z (Note 2)	Zener Test Current I_{ZT}	Maximum Zener Impedance Z_{ZT} @ I_{ZT} (Note 3)	Maximum Zener Knee Impedance Z_{ZK} @ I_{ZK} (Note 3)	Maximum DC Zener Current, I_{ZM}	Maximum Surge Current, I_{ZSM}	Maximum Reverse Leakage, I_R @ V_R	Maximum Temperature Coefficient, α_{VZ}		
	Volts	mA	Ohms	Ohms	mA	mA	μA	%/°C		
1N957B-1	6.8	18.5	4.5	700	1.0	55	300	150	5.2	+0.050
1N958B-1	7.5	16.5	5.5	700	.5	50	275	75	5.7	+0.058
1N959B-1	8.2	15.0	6.5	700	.5	45	250	50	6.2	+0.065
1N960B-1	9.1	14.0	7.5	700	.5	41	225	25	6.9	+0.068
1N961B-1	10	12.5	8.5	700	.25	38	200	10	7.6	+0.075
1N962B-1	11	11.5	9.5	700	.25	35	590	1.0	8.4	+0.073
1N963B-1	12	10.5	11.5	700	.25	32	540	1.0	9.1	+0.076
1N964B-1	13	9.5	13	700	.25	30	500	0.5	9.9	+0.079
1N965B-1	15	8.5	16	700	.25	26	433	0.5	11	+0.082
1N966B-1	16	7.8	17	700	.25	25	406	0.5	12	+0.083
1N967B-1	18	7.0	21	750	.25	21	361	0.5	14	+0.085
1N968B-1	20	6.2	25	750	.25	19	325	0.5	15	+0.086
1N969B-1	22	5.6	29	750	.25	17	295	0.5	17	+0.087
1N970B-1	24	5.2	33	750	.25	16	271	0.5	18	+0.088
1N971B-1	27	4.6	41	750	.25	14	240	0.5	21	+0.090
1N972B-1	30	4.2	49	1000	.25	13	216	0.5	23	+0.091
1N973B-1	33	3.8	58	1000	.25	12	197	0.5	25	+0.092
1N974B-1	36	3.4	70	1000	.25	11	180	0.5	27	+0.093
1N975B-1	39	3.2	80	1000	.25	9.1	166	0.5	30	+0.094
1N976B-1	43	3.0	93	1000	.25	8.8	151	0.5	33	+0.095
1N977B-1	47	2.7	105	1500	.25	7.9	138	0.5	36	+0.095
1N978B-1	51	2.5	125	1500	.25	7.4	127	0.5	39	+0.096
1N979B-1	56	2.2	150	2000	.25	6.9	116	0.5	43	+0.096
1N980B-1	62	2.0	185	2000	.25	6.0	105	0.5	47	+0.097
1N981B-1	68	1.8	230	2000	.25	5.5	95	0.5	52	+0.097
1N982B-1	75	1.7	270	2000	.25	5.1	86	0.5	56	+0.098
1N983B-1	82	1.5	330	3000	.25	4.6	79	0.5	62	+0.098
1N984B-1	91	1.4	400	3000	.25	4.2	71	0.5	69	+0.099
1N985B-1	100	1.3	500	3000	.25	3.7	65	0.5	76	+0.110
1N986B-1	110	1.1	750	4000	.25	3.3	59	0.5	84	+0.110

Electrical specifications @ $T_A = +25^\circ C$ (unless otherwise specified).

NOTE 1: The JEDEC type numbers shown (B Suffix) have a $\pm 5\%$ tolerance on nominal Zener Voltage. The suffix A is used to identify $\pm 10\%$ tolerance; suffix C is used to identify $\pm 2\%$; and suffix D is used to identify $\pm 1\%$; no suffix indicates $\pm 20\%$.

NOTE 2: Zener voltage is measured with the device junction in thermal equilibrium at an ambient temperature of $25^\circ C \pm 3^\circ C$.

NOTE 3: Zener impedance is derived by superimposing on I_{ZT} A 60 Hz rms a.c. current equal to 10% of I_{ZT} .

Diodes for HiRel Applications

Temperature Compensated (TC) Zener Reference Diodes 6.4V Nominal Zener Voltage

Available in JAN, JANTX, JANTXV and JANS levels to MIL-PRF-19500 slash sheets /159 and /452 in both axial leaded and MELF packages. Other features include metallurgically bonded and double plug construction.

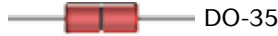

DO-35



DO-213AA

TC Zener Diodes 1N4565UR to 1N4584UR, -1

aeroflex.com/MetelicsHRC

	Zener Test Current I_Z	Effective Temperature Coefficient	Voltage Temperature Stability (ΔV_Z) (Note 1)	Temperature Range	Maximum Dynamic Zener Impedance (Note 2)
Types 6.4V \pm 5% (Note 1)	mA	% / °C	mV	°C	Ohms (Ω)
1N4565-1, 1N4565UR-1 1N4565A-1, 1N4565AUR-1	0.5 0.5	0.01 0.01	48 100	0 to +75°C -55 to +100°C	200 200
1N4566-1, 1N4566UR-1 1N4566A-1, 1N4566AUR-1	0.5 0.5	0.005 0.005	24 50	0 to +75°C -55 to +100°C	200 200
1N4567-1, 1N4567UR-1 1N4567A-1, 1N4567AUR-1	0.5 0.5	0.002 0.002	10 20	0 to +75°C -55 to +100°C	200 200
1N4568-1, 1N4568UR-1 1N4568A-1, 1N4568AUR-1	0.5 0.5	0.001 0.001	5 10	0 to +75°C -55 to +100°C	200 200
1N4569-1, 1N4569UR-1 1N4569A-1, 1N4569AUR-1	0.5 0.5	0.0005 0.0005	2.5 5	0 to +75°C -55 to +100°C	200 200
1N4570-1, 1N4570UR-1 1N4570A-1, 1N4570AUR-1	1.0 1.0	0.01 0.01	48 100	0 to +75°C -55 to +100°C	100 100
1N4571-1, 1N4571UR-1 1N4571A-1, 1N4571AUR-1	1.0 1.0	0.005 0.005	24 50	0 to +75°C -55 to +100°C	100 100
1N4572-1, 1N4572UR-1 1N4572A-1, 1N4572AUR-1	1.0 1.0	0.002 0.002	10 20	0 to +75°C -55 to +100°C	100 100
1N4573-1, 1N4573UR-1 1N4573A-1, 1N4573AUR-1	1.0 1.0	0.001 0.001	5 10	0 to +75°C -55 to +100°C	100 100
1N4574-1, 1N4574UR-1 1N4574A-1, 1N4574AUR-1	1.0 1.0	0.0005 0.0005	2.5 5	0 to +75°C -55 to +100°C	100 100
1N4575-1, 1N4575UR-1 1N4575A-1, 1N4575AUR	2.0 2.0	0.01 0.01	48 100	0 to +75°C -55 to +100°C	50 50
1N4576, 1N4576UR 1N4576A, 1N4576AUR-1	2.0 2.0	0.005 0.005	24 50	0 to +75°C -55 to +100°C	50 50
1N4577-1, 1N4577UR-1 1N4577A-1, 1N4577AUR-1	2.0 2.0	0.002 0.002	10 20	0 to +75°C -55 to +100°C	50 50
1N4578-1, 1N4578UR-1 1N4578A-1, 1N4578AUR-1	2.0 2.0	0.001 0.001	5 10	0 to +75°C -55 to +100°C	50 50
1N4579-1, 1N4579UR-1 1N4579A-1, 1N4579AUR-1	2.0 2.0	0.0005 0.0005	2.5 5	0 to +75°C -55 to +100°C	50 50
1N4580-1, 1N4580UR-1 1N4580A-1, 1N4580AUR-1	4.0 4.0	0.01 0.01	48 100	0 to +75°C -55 to +100°C	25 25
1N4581-1, 1N4581UR-1 1N4581A-1, 1N4581AUR-1	4.0 4.0	0.005 0.005	24 50	0 to +75°C -55 to +100°C	25 25
1N4582-1, 1N4582UR-1 1N4582A-1, 1N4582AUR-1	4.0 4.0	0.002 0.002	10 20	0 to +75°C -55 to +100°C	25 25
1N4583-1, 1N4583UR-1 1N4583A-1, 1N4583AUR-1	4.0 4.0	0.001 0.001	5 10	0 to +75°C -55 to +100°C	25 25
1N4584-1, 1N4584UR-1 1N4584A-1, 1N4584AUR-1	4.0 4.0	0.0005 0.0005	2.5 5	0 to +75°C -55 to +100°C	25 25

Electrical specifications @ +25°C (unless otherwise specified).

NOTE 1: The maximum allowable change observed over the entire temperature range i.e., the diode voltage will not exceed the specified mV at any discrete temperature between the established limits, per JEDEC standard No. 5.

NOTE 2: Zener impedance is derived by superimposing on I_Z A 60 Hz rms a.c. current equal to 10% of I_Z .

Diodes for HiRel Applications

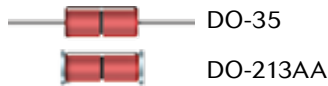

TC Zener Diodes 1N821 to 1N828, -1 1N821UR-1N828UR, -1 aeroflex.com/MetelicsHRC

Types	Zener Voltage V_Z @ I_{ZT}	Zener Test Current I_{ZT}	Maximum Zener Impedance Z_{ZT} (Note 1)	Voltage Temperature Stability, ΔV_Z -55°C to +100°C (Note 2)	Effective Temperature Coefficient
	Volts	mA	Ohms (Ω)	mV	% / °C
1N821-1, 1N821UR-1	5.9-6.5	7.5	15	96	0.01
1N821A-1, 1N821AUR-1	5.9-6.5	7.5	10	96	0.01
1N822-1, 1N822UR-1 †	5.9-6.5	7.5	15	96	0.01
1N823-1, 1N823UR-1	5.9-6.5	7.5	15	48	0.005
1N823A-1, 1N823AUR-1	5.9-6.5	7.5	10	48	0.005
1N824-1, 1N824UR-1 †	5.9-6.5	7.5	15	48	0.005
1N825-1, 1N825UR-1	5.9-6.5	7.5	15	19	0.002
1N825A-1, 1N825AUR-1	5.9-6.5	7.5	10	19	0.002
1N826-1, 1N826UR-1	6.2-6.9	7.5	15	20	0.002
1N827-1, 1N827UR-1	5.9-6.5	7.5	15	9	0.001
1N827A-1, 1N827AUR-1	5.9-6.5	7.5	10	9	0.001
1N828-1, 1N828UR-1	6.2-6.9	7.5	15	10	0.001
1N829-1, 1N829UR-1	5.9-6.5	7.5	15	5	0.0005
1N829A-1, 1N829AUR-1	5.9-6.5	7.5	10	5	0.0005

† Double Anode: Electrical Specifications Apply Under Both Bias Polarities.

Electrical specifications @ +25°C (unless otherwise specified).

NOTE 1: Zener impedance is derived by superimposing on I_{ZT} A 60 Hz rms a.c. current equal to 10% of I_{ZT} .

NOTE 2: The maximum allowable change observed over the entire temperature range i.e., the diode voltage will not exceed the specified mV at any discrete temperature between the established limits, per JEDEC standard No. 5.

Silicon Switching Diodes

Available in JAN, JANTX, JANTXV levels to MIL-PRF-19500 slash sheets /116, /144, /231, and JAN, JANTX, JANTXV, and JANS /578 & /609 in both axial leaded and MELF packages. Other features include Metallurgically Bonded; Hermetically Sealed and Double Plug Construction.

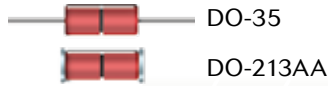

Switching Diodes 1N3600, 1N4150-1 aeroflex.com/MetelicsHRC

Types	V_{BR} $I_R = 10 \mu A$	V_{RMM}	I_{R1} $V_R = 50 V_{dc}$ $T_A = 25^\circ C$	I_{R2} $V_R = 50 V_{dc}$ $T_A = 150^\circ C$	C $I_R = 0$; $f = 1 MHz$ AC signal = 50 mV (p-p)	t_{rr} $I_F = 10 - 100 mA$ $V_L = 100 \Omega$	V_{T1} $I_F = 1 mA$ dc	V_{T2} $I_F = 10 mA$ dc	V_{T3} $I_F = 50 mA$ dc (pulsed)	V_{T4} $I_F = 100 mA$ dc (pulsed)	V_{T5} $I_F = 200 mA$ dc (pulsed)					
	Volts	V(pk)	μA dc	μA dc	pF	nA	V dc min	V dc max	V dc min	V dc max	V dc min	V dc max	V dc min	V dc max	V dc min	V dc max
1N3600	75	50	0.1	100	2.5	4.0	0.54	0.62	0.66	0.74	0.76	0.86	0.82	0.92	0.87	1.00
1N4150-1, 1N4150UR-1	75	50	0.1	100	2.5	4.0	0.54	0.62	0.66	0.74	0.76	0.86	0.82	0.92	0.87	1.00

Electrical specifications @ +25°C (unless otherwise specified).



Switching Diodes 1N914 & 1N4148-1 aeroflex.com/MetelicsHRC

Types	V_{BR} @ 100 μA	V_{RMM}	I_O	V_{T1} $I_F = 10 mA$	V_{T2} $I_F = 50 mA$	t_{rr} $I_F = 10 mA$ $I_A = 10 mA$ $R_L = 100 \Omega$	I_{R1} @ 20 Vdc	I_{R2} @ 75 Vdc	I_{R3} $V_R = 20 V$ $T_A = 150^\circ C$	I_{R4} $V_R = 20 V$ $T_A = 150^\circ C$	Capacitance @ 0 V	Capacitance @ 1.5 V
	Volts	V(pk)	mA	V dc	V dc	nsec	nA	μA	μA	μA	pF	pF
1N914, 1N914UR	100	75	75	0.8	1.2	5	25	0.5	35	75	4.0	2.8
1N4148-1, 1N4148UR-1	100	75	200	0.8	1.2	5	35	0.5	35	75	4.0	2.8

Electrical specifications @ +25°C (unless otherwise specified).

Diodes for HiRel Applications



D-5D

Switching Diodes 1N6638 Series

aeroflex.com/MetelicsHRC

Types	$V_{BR} @ I_R$		V_{RWM}	$V_{FR} / t_T @ I_F = 200 \text{ mA}$		$C_{T1} V_R = 0.0 \text{ V}$		$C_{T2} V_R = 1.5 \text{ V}$		$t_{tr} I_R = 10 \text{ mA}$ $I_F = 10 \text{ mA}$		$V_{R1} V_R = V_{RWM}$		$I_{R2} V_R = 20 \text{ V}$ $T_A = 150^\circ\text{C}$		$I_{R3} V_R = 20 \text{ V}$ $T_A = 150^\circ\text{C}$		$I_{R4} V_R = V_{RWM}$		$V_f @ f$		$V_f @ I_F$ $T_A = -55^\circ\text{C}$		I_F
	V(pk)	μA		V(pk)	$\frac{V_{FR}}{V(pk)}$	t_{tr} ns	pF	pF	ns	nA dc	nA dc	μA dc	μA dc	V dc min	V dc max	V dc max	mA pulsed							
1N6638	150	100	125	5.0	20	2.5	2.0	4.5	35	500	50	100	-	1.1	1.2	200								
1N6639	100	10	75	5.0	10	2.5	-	4.0	-	100	-	90	-	1.2	1.3	500								
1N6640	75	10	50	5.0	10	2.5	-	4.0	-	100	-	90	0.54	0.62	-	1								
													0.76	0.86	-	50								
													0.82	0.92	-	100								
													0.87	1.0	1.1	200								
1N6641	75	10	50	5.0	10	3.0	-	5.0	-	100	-	90	-	1.1	1.2	200								
1N6642	100	100	75	5.0	20	5.0	2.8	5.0	25	500	50	100	-	1.0	-	10								
													1.2	1.2	100									
1N6643	75	100	50	5.0	20	5.0	2.8	6.0	50	500	75	100	-	1.0	-	10								
													1.2	1.4	100									

Electrical specifications @ $T_A = +25^\circ\text{C}$ (unless otherwise specified).



D-5DUS



UB

Switching Diodes 1N6638U Series

aeroflex.com/MetelicsHRC

Types	$V_{BR} @ I_R$		V_{RWM}	$V_{FR} / t_T @ I_F = 200 \text{ mA}$		$C_{T1} V_R = 0.0 \text{ V}$		$C_{T2} V_R = 1.5 \text{ V}$		$t_{tr} I_R = 10 \text{ mA}$ $I_F = 10 \text{ mA}$		$I_{R1} V_R = V_{RWM}$		$I_{R2} V_R = 20 \text{ V}$ $T_A = 150^\circ\text{C}$		$I_{R3} V_R = 20 \text{ V}$ $T_A = 150^\circ\text{C}$		$I_{R4} V_R = V_{RWM}$		$V_f @ f$		$V_f @ I_F$ $T_A = -55^\circ\text{C}$		I_F
	V(pk)	μA		V(pk)	$\frac{V_{FR}}{V(pk)}$	t_{tr} ns	pF	pF	ns	nA dc	nA dc	μA dc	μA dc	V dc min	V dc max	V dc max	mA pulsed							
1N6638U and US	150	100	125	5.0	20	2.5	2.0	4.5	35	500	50	100	-	1.1	1.2	200								
1N6639U and US	100	10	75	5.0	10	2.5	-	4.0	-	100	-	90	-	1.2	1.3	500								
1N6640U and US	75	10	50	5.0	10	2.5	-	4.0	-	100	-	90	0.54	0.62	-	1								
													0.76	0.86	-	50								
													0.82	0.92	-	100								
													0.87	1.0	1.1	200								
1N6641U and US	75	10	50	5.0	10	3.0	-	5.0	-	100	-	90	-	1.1	1.2	200								
1N6642U, US and UB	100	100	75	5.0	20	5.0	2.8	5.0	25	500	50	100	-	1.0	-	10								
													1.2	1.2	100									
1N6643U and US	75	100	50	5.0	20	5.0	2.8	6.0	50	500	75	100	-	1.0	-	10								
													1.2	1.4	100									

Electrical specifications @ $T_A = +25^\circ\text{C}$ (unless otherwise specified).



DO-34

Switching Diodes 1N4531

aeroflex.com/MetelicsHRC

Types	V_f		I_R			V_{BR}		$t_{tr} I_R = 10 \text{ mA}$ $I_{FEC} = 100 \Omega$		$T_{FR} @ I_F = 50 \text{ mA}$		$V_{FR} @ I_F = 50 \text{ mA}$		Capacitance @ 0 V		Capacitance @ 1.5 V	
	Ambient ($^\circ\text{C}$)	I_F mA	V dc max	Ambient ($^\circ\text{C}$)	V dc	A max	Ambient ($^\circ\text{C}$)	I_R μA	V dc max	V dc max	nsec	nsec	V(pk)	pF	pF		
1N4531-1	25	10	0.8	25	20	0.025	25	100	100	25	5	20	5	4	2.8		
	25	100	1.2	25	75	0.500											
	150	10	0.8	150	20	35.0											
	-55	100	1.3	150	75	75.0											



DO-35



DO-213AA

Switching Diodes 1N4454-1

aeroflex.com/MetelicsHRC

Types	$V_{BR} @ 5 \mu\text{A}$		V_{RWM}	I_b	$V_{T1} I_F = 10 \text{ mA}$		$V_{T2} I_F = 10 \text{ mA}$		t_{tr}	$I_{R1} @ 50 \text{ Vdc}$		$I_{R2} @ 75 \text{ Vdc}$ $T_A = 150^\circ\text{C}$		Capacitance @ 0 V
	Volts	V(pk)			mA	V dc	V dc	nsec		μA	μA	pF		
1N4454-1, 1N4454UR-1	75	50	200	0.8	0.7	4	0.1	100	2.0					

Diodes for HiRel Applications

Current Regulators

Available in JAN, JANTX, JANTXV, and JANS levels to MIL-PRF-19500 slash sheet /463 in both axial leaded and MELF packages.



DO-35



DO-213AA

Current Regulator Diode Series
1N5283-1 to 1N5314-1,
1N7041-1 to 1N7055-1
aeroflex.com/MetelicsHRC

Regulator Current
 I_p (mA) @ $V_S = 25V$

Maximum Dynamic
 Impedance
 @ $V_S = 25V$
 Z_S (M) (Note 1)

Minimum Knee
 Impedance
 @ $V_K = 6.0V$
 Z_K (M) (Note 2)

Maximum Limiting
 Voltage
 @ $I_L = 0.8 I_p$ (min)
 V_L (volts)

Peak Operating
 Voltage

Types	Nominal	Minimum	Maximum				Volts
1N5283-1, 1N5283UR-1	0.22	0.198	0.242	25.0	2.75	1.00	100
1N5284-1, 1N5284UR-1	0.24	0.216	0.264	19.0	2.35	1.00	100
1N5285-1, 1N5285UR-1	0.27	0.243	0.297	14.0	1.95	1.00	100
1N5286-1, 1N5286UR-1	0.30	0.270	0.330	9.0	1.60	1.00	100
1N5287-1, 1N5287UR-1	0.33	0.297	0.363	8.0	1.35	1.00	100
1N5288-1, 1N5288UR-1	0.39	0.351	0.429	4.10	1.000	1.05	100
1N5289-1, 1N5289UR-1	.043	0.387	0.473	3.30	0.870	1.05	100
1N5290-1, 1N5290UR-1	0.47	0.423	0.517	2.70	0.750	1.05	100
1N5291-1, 1N5291UR-1	0.56	0.504	0.616	1.90	0.560	1.10	100
1N5292-1, 1N5292UR-1	0.62	0.558	0.682	1.55	0.470	1.13	100
1N5293-1, 1N5293UR-1	0.68	0.612	0.748	1.35	0.400	1.15	100
1N5294-1, 1N5294UR-1	0.75	0.675	0.825	1.15	0.335	1.20	100
1N5295-1, 1N5295UR-1	0.82	0.738	0.902	1.00	0.290	1.25	100
1N5296-1, 1N5296UR-1	0.91	0.819	1.001	0.88	0.240	1.29	100
1N5297-1, 1N5297UR-1	1.00	0.900	1.100	0.80	0.205	1.35	100
1N5298-1, 1N5298UR-1	1.10	0.99	1.21	0.70	0.180	1.40	100
1N5299-1, 1N5299UR-1	1.20	1.08	1.32	0.64	0.155	1.45	100
1N5300-1, 1N5300UR-1	1.30	1.17	1.43	0.58	0.135	1.50	100
1N5301-1, 1N5301UR-1	1.40	1.26	1.54	0.54	0.115	1.55	100
1N5302-1, 1N5302UR-1	1.50	1.35	1.65	0.51	0.105	1.60	100
1N5303-1, 1N5303UR-1	1.60	1.44	1.76	0.475	0.092	1.65	100
1N5304-1, 1N5304UR-1	1.80	1.62	1.98	0.420	0.074	1.75	100
1N5305-1, 1N5305UR-1	2.00	1.80	2.20	0.395	0.061	1.85	100
1N5306-1, 1N5306UR-1	2.20	1.98	2.42	0.370	0.052	1.95	100
1N5307-1, 1N5307UR-1	2.40	2.16	2.54	0.345	0.044	2.00	100
1N5308-1, 1N5308UR-1	2.70	2.43	2.97	0.320	0.035	2.15	100
1N5309-1, 1N5309UR-1	3.00	2.70	3.30	0.300	0.029	2.25	100
1N5310-1, 1N5310UR-1	3.30	2.97	3.63	0.280	0.024	2.35	100
1N5311-1, 1N5311UR-1	3.60	3.24	3.96	0.265	0.020	2.50	100
1N5312-1, 1N5312UR-1	3.90	3.51	4.29	0.255	0.017	2.60	100
1N5313-1, 1N5313UR-1	4.30	3.87	4.73	0.245	0.014	2.75	100
1N5314-1, 1N5314UR-1	4.70	4.23	5.17	0.235	0.012	2.90	100
1N7048-1, 1N7048UR-1	5.10	4.59	5.61	100	4.0	3.67	80
1N7049-1, 1N7049UR-1	5.60	5.04	6.16	90	4.0	4.03	80
1N7050-1, 1N7050UR-1	6.20	5.58	6.82	80	3.0	4.46	70
1N7051-1, 1N7051UR-1	6.80	6.12	7.48	70	2.0	4.90	70
1N7052-1, 1N7052UR-1	7.50	6.75	8.25	50	1.5	5.40	60
1N7053-1, 1N7053UR-1	8.20	7.38	9.02	30	1.5	5.90	60
1N7054-1, 1N7054UR-1	9.10	8.19	10.01	20	1.0	6.55	50
1N7055-1, 1N7055UR-1	10.00	9.00	11.10	10	1.0	7.20	50

Electrical specifications @ +25°C (unless otherwise specified).

NOTE 1: Z_S is derived by superimposing A 90 Hz RMS signal equal to 10% of V_S on V_S

NOTE 2: Z_K is derived by superimposing A 90 Hz RMS signal equal to 10% of V_K on V_K

Available in chip form.

Diodes for HiRel Applications

Zener Diode Chip Series CD5518B – CD5546B aeroflex.com/MetelicsHRC

Types	Nominal Zener Voltage, $V_Z @ I_{ZT}$ (Note 1)	Zener Test Current, I_{ZT}	Maximum Zener Impedance, $Z_{ZT} @ I_{ZT}$ (Note 2)	Maximum Reverse Leakage Current, I_R	Maximum Reverse Leakage Current, V_R	Regulation Factor, V_Z (Note 3)	Low V_Z Current, I_{ZL}
	Volts	mAdc	Ohms	mAdc	Volts	Volts	mAdc
CD5518B	3.3	20	26	5.0	1.0	0.90	2.0
CD5519B	3.6	20	24	3.0	1.0	0.90	2.0
CD5520B	3.9	20	22	1.0	1.0	0.90	2.0
CD5521B	4.3	20	18	3.0	1.5	0.75	2.0
CD5522B	4.7	10	22	2.0	2.0	0.60	1.0
CD5523B	5.1	5.0	26	2.0	2.5	0.65	0.25
CD5524B	5.6	3.0	30	2.0	3.5	0.30	0.25
CD5525B	6.2	1.0	30	1.0	5.0	0.20	0.01
CD5526B	6.8	1.0	30	1.0	6.2	0.10	0.01
CD5527B	7.5	1.0	35	0.5	6.8	0.05	0.01
CD5528B	8.2	1.0	40	0.5	7.5	0.05	0.01
CD5529B	9.1	1.0	45	0.1	8.2	0.05	0.01
CD5530B	10.0	1.0	60	0.05	9.1	0.10	0.01
CD5531B	11.0	1.0	80	0.05	9.9	0.20	0.01
CD5532B	12.0	1.0	90	0.05	10.8	0.20	0.01
CD5533B	13.0	.0	90	0.01	11.7	0.20	0.01
CD5534B	14.0	1.0	100	0.01	12.6	0.20	0.01
CD5535B	15.0	1.0	100	0.01	13.5	0.20	0.01
CD5536B	16.0	1.0	100	0.01	14.4	0.20	0.01
CD5537B	17.0	1.0	100	0.01	15.3	0.20	0.01
CD5538B	18.0	1.0	100	0.01	16.2	0.20	0.01
CD5539B	19.0	1.0	100	0.01	17.1	0.20	0.01
CD5540B	20.0	1.0	100	0.01	18.0	0.20	0.01
CD5541B	22.0	1.0	100	0.01	19.8	0.25	0.01
CD5542B	24.0	1.0	100	0.01	21.6	0.30	0.01
CD5543B	25.0	1.0	100	0.01	22.4	0.35	0.01
CD5544B	28.0	1.0	100	0.01	25.2	0.40	0.01
CD5545B	30.0	1.0	100	0.01	27.0	0.45	0.01
CD5546B	33.0	1.0	100	0.01	29.7	0.50	0.01

Electrical specifications @ +25°C (unless otherwise specified). **AVAILABLE IN JANHC AND JANKC PER MIL-PRF-19500/437.**

NOTE 1: Suffix "B" voltage range equals nominal Zener voltage. $\pm 5\%$. Suffix "A" equals $\pm 10\%$. "C" suffix = $\pm 2\%$ and "D" suffix = $\pm 1\%$. No Suffix equals $\pm 20\%$. Zener voltage is read using a pulse measurement, 10 milliseconds maximum.

NOTE 2: Zener impedance is derived by superimposing on I_{ZT} a 60 Hz rms ac current equal to 10 % of I_{ZT} .

NOTE 3: ΔV_Z is the maximum difference between $V_Z @ I_{ZT}$ and V_Z at I_{ZL} measured with the device junction in thermal equilibrium at an ambient temperature of $+25^\circ \pm 3^\circ\text{C}$.

Zener Diode Chip Series CD4614 – CD4627 aeroflex.com/MetelicsHRC

Types	Nominal Zener Voltage, $V_Z @ I_{ZT}$ (Note 1)	Zener Test Current, I_{ZT}	Maximum Zener Impedance, $Z_{ZT} @ I_{ZT}$ (Note 2)	Maximum Reverse Leakage Current, $I_R @ V_R$
	Volts	μA	Ohms	μA
CD4614	1.8	250	1200	7.5
CD4615	2.0	250	1250	5.0
CD4616	2.2	250	1300	4.0
CD4617	2.4	250	1400	2.0
CD4618	2.7	250	1500	1.0
CD4619	3.0	250	1600	0.8
CD4620	3.3	250	1650	7.5
CD4621	3.6	250	1700	7.5
CD4622	3.9	250	1650	5.0
CD4623	4.3	250	1600	4.0
CD4624	4.7	250	1550	10.0
CD4625	5.1	250	1500	10.0
CD4626	5.6	250	1400	10.0
CD4627	6.2	250	1200	10.0

Electrical specifications @ +25°C (unless otherwise specified). **AVAILABLE IN JANHC AND JANKC PER MIL-PRF-19500/435.**

NOTE 1: Zener voltage range equals nominal Zener voltage $\pm 5\%$ for no suffix types. Zener voltage is read using a pulse measurement, 10 milliseconds maximum. "C" suffix = $\pm 2\%$ and "D" suffix = $\pm 1\%$.

NOTE 2: Zener impedance is derived by superimposing on I_{ZT} a 60 Hz rms AC current equal to 10 % of I_{ZT} .

Diodes for HiRel Applications

**TC Zener Diode
Chip Series
CD4565 – CD4584A**
aeroflex.com/MetelicsHRC

	Zener Test Current I_{ZT}	Effective Temperature Coefficient	Voltage Temperature Stability, $\Delta V_{ZT, Max}$ -55° to +100° (Note 1)	Temperature Range	Maximum Zener Impedance Z_{ZT} (Note 2)
Types 6.4 V $\pm 5\%$	mA	% / °C	Ohms	°C	Ohms
CD4565	0.5	0.01	48	0 to +75 °C	200
CD4565A	0.5	0.01	100	-55 to +100 °C	200
CD4566	0.5	0.005	24	0 to +75 °C	200
CD4566A	0.5	0.005	50	-55 to +100 °C	200
CD4567	0.5	0.002	10	0 to +75 °C	200
CD4567A	0.5	0.002	20	-55 to +100 °C	200
CD4568	0.5	0.001	5	0 to +75 °C	200
CD4568A	0.5	0.001	10	-55 to +100 °C	200
CD4569	0.5	0.0005	2.5	0 to +75 °C	200
CD4569A	0.5	0.0005	5	-55 to +100 °C	200
CD4570	1.0	0.01	48	0 to +75° C	100
CD4570A	1.0	0.01	100	-55 to +100 °C	100
CD4571	1.0	0.005	24	0 to +75°C	100
CD4571A	1.0	0.005	50	-55 to +100°C	100
CD4572	1.0	0.002	10	0 to +75°C	100
CD4572A	1.0	0.002	20	-55 to +100°C	100
CD4573	1.0	0.001	5	0 to +75 °C	100
CD4573A	1.0	0.001	10	-55 to +100 °C	100
CD4574	1.0	0.0005	2.5	0 to +75 °C	100
CD4574A	1.0	0.0005	5	-55 to +100 °C	100
CD4575	2.0	0.01	48	0 to +75°C	50
CD4575A	2.0	0.01	100	-55 to +100 °C	50
CD4576	2.0	0.005	24	0 to +75 °C	50
CD4576A	2.0	0.005	50	-55 to +100 °C	50
CD4577	2.0	0.002	10	0 to +75 °C	50
CD4577A	2.0	0.002	20	-55 to +100 °C	50
CD4578	2.0	0.001	5	0 to +75 °C	50
CD4578A	2.0	0.001	10	-55 to +100 °C	50
CD4579	2.0	0.0005	2.5	0 to +75 °C	50
CD4579A	2.0	0.0005	5	-55 to +100 °C	50
CD4580	4.0	0.01	48	0 to +75 °C	25
CD4580A	4.0	0.01	100	-55 to +100 °C	25
CD4581	4.0	0.005	24	0 to +75 °C	25
CD4581A	4.0	0.005	50	-55 to +100 °C	25
CD4582	4.0	0.002	10	0 to +75 °C	25
CD4582A	4.0	0.002	20	-55 to +100 °C	25
CD4583	4.0	0.001	5	0 to +75 °C	25
CD4583A	4.0	0.001	10	-55 to +100 °C	25
CD4584	4.0	0.0005	2.5	0 to +75° C	25
CD4584A	4.0	0.0005	5	-55 to +100 °C	25

Electrical specifications @ +25 °C (unless otherwise specified). **AVAILABLE IN JANHC AND JANKC PER MIL-PRF-19500/452.**

NOTE 1: The maximum allowable change observed over the entire temperature range, i.e., the diode voltage will not exceed the specialized mV at any discrete temperature between the established limits, per JEDEC standard No.5.

NOTE 2: Zener impedance is derived by superimposing on I_{ZT} a 60 Hz rms ac current equal to 10% of I_{ZT} .

Diodes for HiRel Applications

**Zener Diode
Chip Series
CD4099 – CD4135**
aeroflex.com/MetelicsHRC

	Nominal Zener Voltage, V_Z @ I_{ZT} (Note 1)	Zener Test Current, I_{ZT}	Maximum Zener Impedance, Z_T @ I_{ZT} (Note 2)	Maximum Reverse Leakage Current, I_R @ V_R
Types	Volts	μA	Ohms	μA
CD4099	6.8	250	200	10.0
CD4100	7.5	250	200	10.0
CD4101	8.2	250	200	1.0
CD4102	8.7	250	200	1.0
CD4103	9.1	250	200	1.0
CD4104	10	250	200	1.0
CD4105	11	250	200	0.05
CD4106	12	250	200	0.05
CD4107	13	250	200	0.05
CD4108	14	250	200	0.05
CD4109	15	250	100	0.05
CD4110	16	250	100	0.05
CD4111	17	250	100	0.05
CD4112	18	250	100	0.05
CD4113	19	250	150	0.05
CD4114	20	250	150	0.01
CD4115	22	250	150	0.01
CD4116	24	250	150	0.01
CD4117	25	250	150	0.01
CD4118	27	250	150	0.01
CD4119	28	250	200	0.01
CD4120	30	250	200	0.01
CD4121	33	250	200	0.01
CD4122	36	250	200	0.01
CD4123	39	250	200	0.01
CD4124	43	250	250	0.01
CD4125	47	250	250	0.01
CD4126	51	250	300	0.01
CD4127	56	250	300	0.01
CD4128	60	250	400	0.01
CD4129	62	250	500	0.01
CD4130	68	250	700	0.01
CD4131	75	250	700	0.01
CD4132	82	250	800	0.01
CD4133	87	250	1000	0.01
CD4134	91	250	1200	0.01
CD4135	100	250	1500	0.01

Electrical specifications @ +25°C (unless otherwise specified). **AVAILABLE IN JANHC AND JANKC PER MIL-PRF-19500/435.**

NOTE 1: Zener voltage range equals nominal Zener voltage \pm 5% for no suffix types. Zener voltage is read using a pulse measurement, 10 milliseconds maximum. "C" suffix = \pm 2% and "D" suffix = \pm 1%.

NOTE 2: Zener impedance is derived by superimposing on I_{ZT} a 60 Hz rms AC current equal to 10 % of I_{ZT} .

Diodes for HiRel Applications

Zener Diode Chip Series CD957B – CD986B aeroflex.com/MetelicsHRC

Types	Nominal Zener Voltage, V_Z (Note 1)	Zener Test Current, I_{ZT}	Maximum Zener Impedance, $Z_Z @ I_{ZT}$ (Note 2)	Maximum Zener Impedance, $Z_Z @ I_{ZK}$ (Note 2)	Maximum DC Zener Current, I_{ZM}	Maximum Reverse Leakage Current, $I_R @ V_R$		
	Volts	mA	Ohms	Ohms	mA	mA	μA	Volts
CD957B	6.8	18.5	4.5	700	1.0	55	5.0	5.2
CD958B	7.5	16.5	5.5	700	0.5	50	5.0	5.7
CD959B	8.2	15.0	6.5	700	0.5	45	5.0	6.2
CD960B	9.1	14.0	7.5	700	0.5	41	5.0	6.9
CD961B	10	12.5	8.5	700	0.25	38	2.0	7.6
CD962B	11	11.5	9.5	700	0.25	32	1.0	8.4
CD963B	12	10.5	11.5	700	0.25	31	1.0	9.1
CD964B	13	9.5	13	700	0.25	28	0.5	9.9
CD965B	15	8.5	16	700	0.25	25	0.5	11
CD966B	16	7.8	17	700	0.25	24	0.5	12
CD967B	18	7.0	21	750	0.25	20	0.5	14
CD968B	20	6.2	25	750	0.25	18	0.5	15
CD969B	22	5.6	29	750	0.25	16	0.5	17
CD970B	24	5.2	33	750	0.25	15	0.5	18
CD971B	27	4.6	41	750	0.25	13	0.5	21
CD972B	30	4.2	49	1000	0.25	12	0.5	23
CD973B	33	3.8	58	1000	0.25	11	0.5	25
CD974B	36	3.4	70	1000	0.25	10	0.5	27
CD975B	39	3.2	90	1000	0.25	9.5	0.5	30
CD976B	43	3.0	93	1500	0.25	8.8	0.5	33
CD977B	47	2.7	105	1500	0.25	7.9	0.5	36
CD978B	51	2.5	125	1500	0.25	7.4	0.5	39
CD979B	56	2.2	150	2000	0.25	6.8	0.5	43
CD980B	62	2.0	185	2000	0.25	6.0	0.5	47
CD981B	68	1.8	230	2000	0.25	5.5	0.5	52
CD982B	75	1.7	270	2000	0.25	5.0	0.5	56
CD983B	82	1.5	330	3000	0.25	4.6	0.5	62
CD984B	91	1.4	400	3000	0.25	4.1	0.5	69
CD985B	100	1.3	500	3000	0.25	3.7	0.5	76
CD986B	110	1.1	750	4000	0.25	3.3	0.5	84

Electrical specifications @ +25°C (unless otherwise specified). **AVAILABLE IN JANHC AND JANKC PER MIL-PRF-19500/117.**

NOTE 1: Zener voltage range equals nominal voltage $\pm 5\%$ for "B" Suffix. "A" Suffix denotes $\pm 10\%$. No Suffix denotes $\pm 20\%$. "C" suffix = $\pm 2\%$ and "D" suffix = $\pm 1\%$. Zener voltage is read using a pulse measurement, 10 milliseconds maximum.

NOTE 2: Zener impedance is derived by superimposing on I_{ZT} a 60 Hz rms a.c. current equal to 10 % of I_{ZT} .

Ultrafast Rectifier Diodes CD5802, CD5804 & CD5806 aeroflex.com/MetelicsHRC

Types	V_{RWM}	V_{BR}	I_O $T_J = 75^\circ C$	T_T $I_F = 0.5 A, I_{RSM} = 0.5 A$ $I_{REC} = 0.5 A$	$C_{j(max)}$ $V_R = 10.0 V$	V_{FM1} $I_{FM} = 1.0 A$ $T_P = 8.3 nS (max)$	V_{FM2} $I_{FM} = 2.5 A$ $T_P = 8.3 nS (max)$	V_{FM3} $I_{FM} = 1.0 A$ $T_A = +125^\circ C$	V_{FM4} $I_{FM} = 1.0 A$ $T_A = -65^\circ C$	$I_R @ V_{RWM}$ $T_C = 25^\circ C$	$I_{R2} @ V_{RWM}$ $T_A = 125^\circ C$ (Rated)	V_{FRM} $t_r = 8 nS$ $I_{FM} = 250 mA$
	V(min)	V(pk)	A	ns	pF	V dc	V dc	V dc	V dc	μA dc	μA dc	V dc
CD5802	50	60	2.5	25	25	0.875	0.975	0.800	1.075	1	175	2.2
CD5804	100	110	2.5	25	25	0.875	0.975	0.800	1.075	1	175	2.2
CD5806	150	160	2.5	25	25	0.875	0.975	0.800	1.075	1	175	2.2

Electrical specifications @ +25°C (unless otherwise specified). **AVAILABLE IN JANHC AND JANKC PER MIL-PRF-19500/477.**

Ultrafast Rectifier Diodes CD5807, CD5809 & CD5811 aeroflex.com/MetelicsHRC

Types	V_{RWM}	V_{BR}	I_O $T_J = 75^\circ C$	T_T $I_F = 1 A, I_{RSM} = 1 A$ $I_{REC} = 0.1 A$	$C_{j(max)}$ $V_R = 10.0 V$	V_{FM1} $I_{FM} = 3.0 A$ $T_P = 8.3 nS (max)$	V_{FM2} $I_{FM} = 4.0 A$ $T_P = 8.3 nS (max)$	V_{FM3} $I_{FM} = 6.0 A$ $T_A = +125^\circ C$	V_{FM4} $I_{FM} = 4.0 A$ $T_A = +125^\circ C$	$I_R @ V_{RWM}$ $T_C = 25^\circ C$	$I_{R2} @ V_{RWM}$ $T_A = 125^\circ C$ (Rated)	V_{FRM} $t_r = 8 nS$ $I_{FM} = 500 mA$
	V(min)	V(pk)	A	ns	pF	V dc	V dc	V dc	V dc	μA dc	μA dc	V dc
CD5807	50	60	2.5	30	60	0.865	0.875	0.925	0.800	5	525	2.2
CD5809	100	110	2.5	30	60	0.865	0.875	0.925	0.800	5	525	2.2
CD5811	150	160	2.5	30	60	0.865	0.875	0.925	0.800	5	525	2.2

Electrical specifications @ +25°C (unless otherwise specified). **AVAILABLE IN JANHC AND JANKC PER MIL-PRF-19500/477.**

Diodes for HiRel Applications

Zener Diode Chip Series CD746A – CD759A, CD4370A – CD4372A aeroflex.com/MetelicsHRC

	Nominal Zener Voltage, $V_Z @ I_{ZT}$ (Note 1)	Zener Test Current, I_{ZT}	Maximum Zener Impedance, $Z_{ZT} @ I_{ZT}$ (Note 2)	Maximum Reverse Leakage Current $I_R @ V_R$	Maximum Zener Current, I_{ZM}	
Types	Volts	mA	Ohms	μA	Volts	mA
CD4370A	2.4	20	30	100	1.0	155
CD4371A	2.7	20	30	75	1.0	140
CD4372A	3.0	20	29	50	1.0	125
CD746A	3.3	20	28	10	1.0	120
CD747A	3.6	20	24	5	1.0	110
CD748A	3.9	20	23	5	1.0	100
CD749A	4.3	20	22	2	1.0	90
CD750A	4.7	20	19	5	1.5	85
CD751A	5.1	20	17	5	2.0	75
CD752A	5.6	20	11	5	2.5	70
CD753A	6.2	20	7	5	3.5	85
CD754A	6.8	20	5	2	4.0	60
CD755A	7.5	20	6	2	5.0	55
CD756A	8.2	20	8	1	6.0	50
CD757A	9.1	20	10	1	7.0	45
CD758A	10.0	20	17	1	8.0	40
CD759A	12.0	20	30	1	9.0	35

Electrical specifications @ +25°C (unless otherwise specified). **AVAILABLE IN JANHC AND JANKC PER MIL-PRF-19500/127.**

NOTE 1: Zener voltage range equals nominal voltage $\pm 5\%$ for "A" Suffix. No Suffix denotes $\pm 10\%$. "C" suffix = $\pm 2\%$ and "D" suffix = $\pm 1\%$. Zener voltage is read using a pulse measurement, 10 milliseconds maximum.

NOTE 2: Zener impedance is derived by superimposing on I_{ZT} a 60 Hz rms a.c. current equal to 10 % of I_{ZT} .

Silicon Switching Diode Chips CD914, CD4148, CD4531, CD6642 & CD4454 aeroflex.com/MetelicsHRC

	$V_{BR} @ 100 \text{ mA}$	V_{RWM}	I_b	V_{F1} $I_F = 10 \text{ mA}$	V_{F2} $I_F = 50 \text{ mA}$	V_{F3} $I_F = 100 \text{ mA}$	t_{rr}	$I_{R1} @ 20 \text{ Vdc}$	I_{R2}	$I_{R3} @ 20 \text{ Vdc}$ $T_A = 150^\circ\text{C}$	I_{R4} $T_A = 150^\circ\text{C}$	Capacitance @ 0 V	Capacitance @ 1.5 V
Types	Volts (min)	Volts (pk)	mA	Vdc	Vdc	Vdc	nsec	nA	$\mu A @ V$	μA	$\mu A @ V$	pF	pF
CD914	100	75	75	0.8	1.2	N/A	5	25	0.5 @ 75	35	75 @ 75	4.0	2.8
CD4148 CD4531 CD6642	100	75	200	0.8	N/A	1.2	5	35	0.5 @ 75	35	75 @ 75	4.0	2.8
CD4454	75	50	200	1.0	N/A	N/A	4	N/A	0.1 @ 50	N/A	100 @ 50	2.0	N/A

Electrical specifications @ +25°C (unless otherwise specified).

CD914, CD4148, CD4531, AVAILABLE IN JANHC AND JANKC PER MIL-PRF-19500/116. CD6642 AVAILABLE IN JANHC AND JANKC PER MIL-PRF-19500/578.

Silicon Switching Diode Chips CD3600, CD4150, CD6640 & CD4153 aeroflex.com/MetelicsHRC

	V_{BR} $I_R = 10 \mu A^*$	V_{RWM}	I_{R1} $V_R = 50 \text{ Vdc}$ $T_A = 150^\circ\text{C}$	I_{R2} $V_R = 50 \text{ Vdc}$ $T_A = 150^\circ\text{C}$	Capacitance $V_R = 0, f = 1 \text{ MHz}$ ac signals = 50 mV (p-p)	t_{rr}
Types	Volts (min)	Volts (pk)	$\mu A \text{ Vdc}$	$\mu A \text{ Vdc}$	pF	nsec
CD3600	75	50	0.10	100	2.5	4
CD4150 CD6640	75	50	0.10	100	2.5	4
CD4153	75*	50	0.05	150	2.0	4

* @ 5 mA for CD4153

Electrical specifications @ +25°C (unless otherwise specified). **CD6640 AVAILABLE IN JANHC AND JANKC PER MIL-PRF-19500/609.**

Diode Packaging

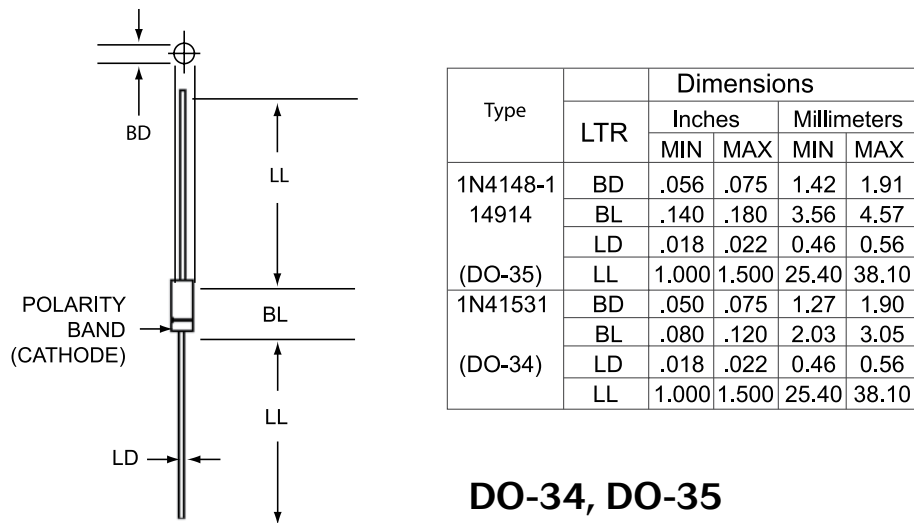
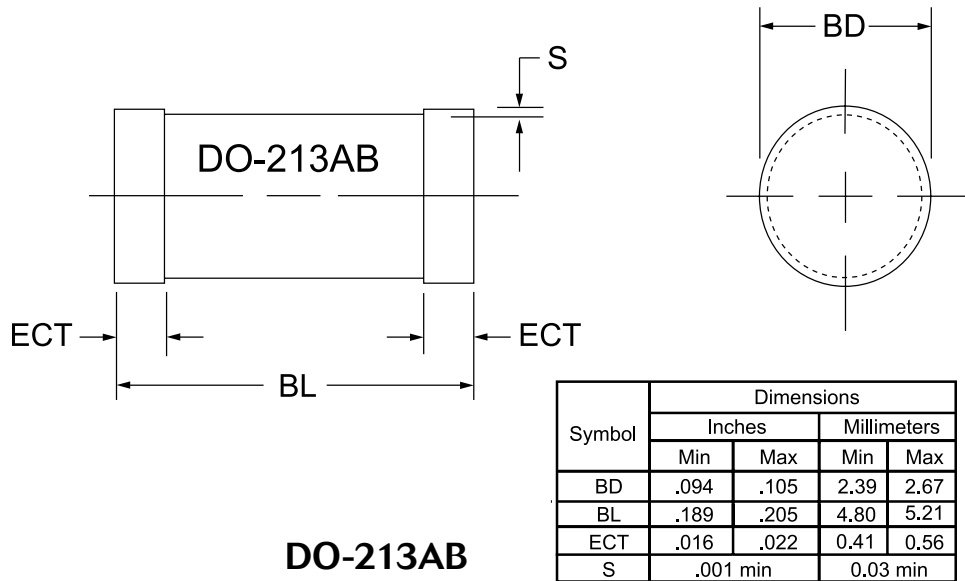
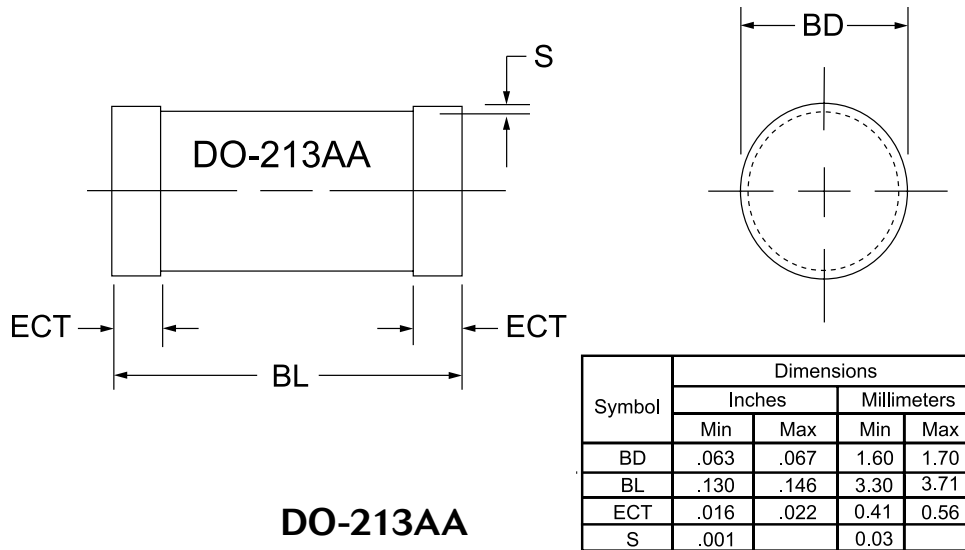

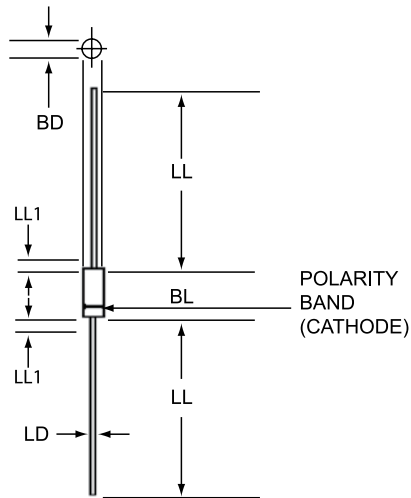

Symbol	Dimensions			
	Inches		Millimeters	
	MIN	MAX	MIN	MAX
BD	.060	.107	1.52	2.72
BL	.120	.300	3.05	7.62
LD	.018	.022	0.46	0.58
LL	1.000	1.500	25.40	38.10
LL1		0.050		1.27

DO-7

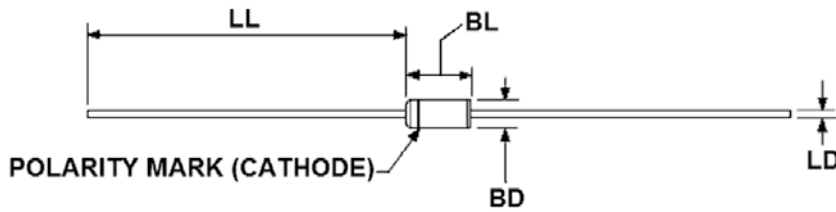

Symbol	Dimensions			
	Inches		Millimeters	
	MIN	MAX	MIN	MAX
BD	.059	.080	1.42	2.03
BL	.130	.180	3.30	4.57
LD	.018	.022	0.46	0.56
LL	1.00	1.50	25.40	38.10

D-5D

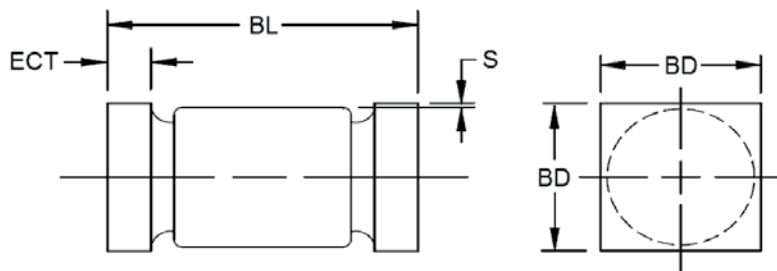

Symbol	Dimensions			
	Inches		Millimeters	
	MIN	MAX	MIN	MAX
BD	.070	.085	1.78	2.16
BL	.165	.195	4.19	4.95
ECT	.019	.028	0.48	0.71
S	0.003		0.08	

D-5DUS

Transistors for HiRel Applications



NPN Transistors

aeroflex.com/transistors

	Slash Sheet	$V_{CE(sus)}$	V_{CBO}	$I_{C(max)}$	$h_{FE} @ I_C / V_{CE}$	C_{obp}	f	Package
NPN Transistors		Volts	Volts	Amps	min/max@AV	pF	MHz	
2N3055	407	70	100	15	20/60 @ 4/4	700	0.8	TO-3
2N3418*	393	60	85	3	20/60 @ 1/2	150	26	TO-5 / TO-39
2N3419*	393	80	125	3	20/60 @ 1/2	150	26	TO-5 / TO-39
2N3420*	393	60	85	3	40/20 @ 1/2	150	26	TO-5 / TO-39
2N3421*	393	80	125	3	40/20 @ 1/2	150	26	TO-5 / TO-39
2N3715	408	60	80	10	30/120 @ 3/2	500	4	TO-3
2N3716	408	80	100	10	30/120 @ 3/2	500	4	TO-3
2N3766	518	60	80	4	40/160 @ .5/5	50	10	TO-66
2N3767	518	80	100	4	40/160 @ .5/5	50	10	TO-66
2N3879	526	75	120	7	20/80 @ 4/5	175	40	TO-66
2N3902	371	400	700	3.5	30/90 @ 1/5	250	2.5	TO-3
2N4150*	394	70	100	10	40/120 @ 5/5	350	15	TO-5 / TO-39 / U3
2N4237	581	40	50	1	30/150 @ .25/1	100	30	TO-39
2N4238	581	60	80	1	30/150 @ .25/1	100	30	TO-39
2N4239	581	80	100	1	30/150 @ .25/1	100	30	TO-39
2N5152*	544	80	100	2	30/90 @ 2.5/5	250	60	TO-5 / TO-39
2N5154*	544	80	100	2	70/200 @ 2.5/5	250	70	TO-5 / TO-39 / U3
2N5157	371	500	700	3.5	30/90 @ 1/5	250	2.5	TO-3
2N5339*	560	100	100	5	60/240 @ 2/2	250	30	TO-5 / TO-39 / U3
2N5681	583	100	100	1.0	40/150 @ .25/2	50	30	TO-39
2N5682	583	120	120	1.0	40/150 @ .25/2	50	30	TO-39
2N6058	502	80	80	12	1K/18K @ 6/3	300	10	TO-3
2N6059	502	100	100	12	1K/18K @ 6/3	300	10	TO-3
2N6249	510	200	300	10	10/50 @ 10/3	500	2.5	TO-3
2N6250	510	275	375	10	8/50 @ 10/3	500	2.5	TO-3
2N6251	510	350	450	10	6/50 @ 10/3	500	2.5	TO-3
2N6283	504	80	80	20	1.25K/18K @ 10/3	350	8	TO-3
2N6284	504	100	100	20	1.25K/18K @ 10/3	350	8	TO-3
2N6300	539	60	60	8	750/18K @ 4/3	200	25	TO-66
2N6301	539	80	80	8	750/18K @ 4/3	200	25	TO-66
2N6383	523	40	40	10	1K/20K @ 5/3	200	20	TO-3
2N6384	523	60	60	10	1K/20K @ 5/3	200	20	TO-3
2N6385	523	80	80	10	1K/20K @ 5/3	200	20	TO-3
2N6674	537	300	450	15	8/20 @ 10/2	500	15	TO-3
2N6675	537	400	650	15	8/20 @ 10/2	500	15	TO-3
2N6676	538	300	450	15	8/20 @ 15/3	500	15	TO-3
2N6678	538	400	650	15	8/20 @ 15/3	500	15	TO-3

AVAILABLE IN JAN, JANTX AND JANTXV PER APPLICABLE SLASH SHEET.

* ALSO AVAILABLE IN JANS.



NPN RadHard Small Signal Transistors

aeroflex.com/transistors

	Slash Sheet	$V_{CE(sus)}$	V_{CBO}	$I_{C(max)}$	$h_{FE} @ I_C / V_{CE}$	C_{obp}	f	Package
RadHard Small Signal Transistors		Volts	Volts	Amps	min/max@AV	pF	MHz	
JANS2N2219	251	50	75	0.8	100/300 @ .15/10	8	250	TO-5 / TO-39
JANS2N2222A	255	50	75	0.8	100/300 @ .15/10	8	250	TO-18, UA, UB
JANS2N2484	376	60	60	0.05	250/800 @ .001/5	5	60	TO-18, UA, UB
JANS2N3019	391	80	140	1	100/300 @ .15/10	12	100	TO-5 / TO-39
JANS2N3700	391	80	140	1	100/300 @ .15/10	12	100	TO-18, UA, UB

JANS2N2222A, UA AND UB QUALIFIED TO MIL-PRF-19500/255.

Transistors for HiRel Applications

PNP Transistors

aeroflex.com/transistors



	Slash Sheet	$V_{CE0(sus)}$	V_{CB0}	$I_C(max)$	$h_{FE} @ I_C / V_{CE}$	C_{ob0}	f_T	Package
PNP Transistors		Volts	Volts	Amps	min/max@A/V	pF	MHz	
2N3740*	441	60	60	4	30/120 @ .25/1	100	5	TO-66
2N3741*	441	80	80	4	30/120 @ .25/1	100	5	TO-66
2N3791	379	60	60	10	30/120 @ 3/2	500	4	TO-3
2N3792	379	80	80	10	30/120 @ 3/2	500	4	TO-3
2N3867*	350	40	40	3	40/200 @ 1.5/2	120	60	TO-5 / TO-39
2N3868*	350	60	60	3	30/150 @ 1.5/2	120	60	TO-5 / TO-39
2N4234	580	40	40	1	30/150 @ .25/1	100	30	TO-39
2N4235	580	60	60	1	30/150 @ .25/1	100	30	TO-39
2N4236	580	80	80	1	30/150 @ .25/1	100	30	TO-39
2N5151*	545	80	100	2	30/90 @ 2.5/5	250	60	TO-5 / TO-39
2N5153*	545	80	100	2	70/200 @ 2.5/5	250	70	TO-5 / TO-39 / U3
2N5679	582	100	100	1	40/150 @ .25/2	50	30	TO-39
2N5680	582	120	120	1	40/150 @ .25/2	50	30	TO-39
2N6051	501	80	80	12	1K/18K @ 6/3	300	10	TO-3
2N6052	501	100	100	12	1K/18K @ 6/3	300	10	TO-3
2N6193*	561	100	100	5	60/240 @ 2/2	300	30	TO-5 / TO-39 / U3
2N6286	505	80	80	20	1.25K/18K @ 10/3	400	8	TO-3
2N6287	505	100	100	20	1.25K/18K @ 10/3	400	8	TO-3
2N6298	540	60	60	8	750/18K @ 4/3	200	25	TO-66
2N6299	540	80	80	8	750/18K @ 4/3	200	25	TO-66

AVAILABLE IN JAN, JANTX, AND JANTXV.

* ALSO AVAILABLE IN JANS.



PNP RadHard Small Signal Transistors

aeroflex.com/transistors

	Slash Sheet	$V_{CE0(sus)}$	V_{CB0}	$I_C(max)$	$h_{FE} @ I_C / V_{CE}$	C_{ob0}	f_T	Package
RadHard Small Signal Transistors		Volts	Volts	Amps	min/max@A/V	pF	MHz	
JANS2N2905A*	290	60	60	0.6	100/300 @ .15/10	8	200	TO-5 / TO-39
JANS2N2907A*	291	60	60	0.6	100/300 @ .15/10	8	250	TO-18, UA, UB

* JANS AND JANSR COMING SOON.



Silicon Controlled Rectifiers

aeroflex.com/transistors

	Slash Sheet	V_{DRM}	I_0	I_{Tmax}	V_{GT}	I_{GT}	I_{HOX}	Package
Silicon Controlled Rectifiers		Volts	mA	μA	Volts min/max	μA	mA	
2N2323	276	50	220	10	0.35/0.80	200	2	TO-5
2N2323S	276	50	220	10	0.35/0.80	200	2	TO-39
2N2323A	276	50	220	10	0.35/0.60	20	2	TO-5
2N2323AS	276	50	220	10	0.35/0.60	20	2	TO-39
2N2324	276	100	220	10	0.35/0.80	200	2	TO-5
2N2324S	276	100	220	10	0.35/0.80	200	2	TO-39
2N2324A	276	100	220	10	0.35/0.60	20	2	TO-5
2N2324AS	276	100	220	10	0.35/0.60	20	2	TO-39
2N2326	276	200	220	10	0.35/0.80	200	2	TO-5
2N2326S	276	200	220	10	0.35/0.80	200	2	TO-39
2N2326A	276	200	220	10	0.35/0.60	20	2	TO-5
2N2326AS	276	200	220	10	0.35/0.60	20	2	TO-39
2N2328	276	300	220	10	0.35/0.80	200	2	TO-5
2N2328S	276	300	220	10	0.35/0.80	200	2	TO-39
2N2328A	276	300	220	10	0.35/0.60	20	2	TO-5
2N2328AS	276	300	220	10	0.35/0.60	20	2	TO-39
2N2329	276	400	220	10	0.35/0.80	200	2	TO-5
2N2329S	276	400	220	10	0.35/0.80	200	2	TO-39
2N2329A	276	400	220	10	0.35/0.60	20	2	TO-5
2N2329AS	276	400	220	10	0.35/0.60	20	2	TO-39

AVAILABLE IN JAN, JANTX AND JANTXV.

Transistor Packaging

TO-3

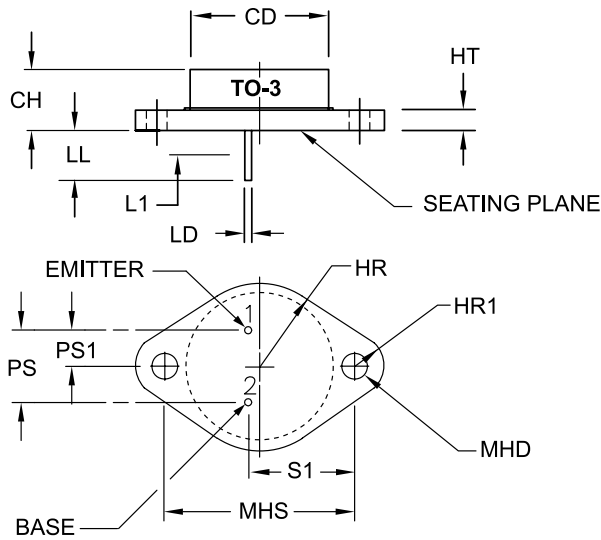

LTR	Dimensions			
	Inches		Millimeters	
	MIN	MAX	MIN	MAX
CD		.875		22.23
CH	.250	.450	6.35	11.43
HR	.495	.525	12.57	13.34
HR1	.131	.188	3.33	4.78
HT	.050	.135	1.27	3.43
LD	.038	.053	0.97	1.35
LL	.312	.500	7.92	12.70
L1		.050		1.27
MHO	.151	.161	3.84	4.09
MHS	1.177	1.197	29.90	30.40
PS	.420	.440	10.67	11.18
PS1	.205	.25	5.21	6.35
S1	.665	.675	16.89	17.15

TO-18

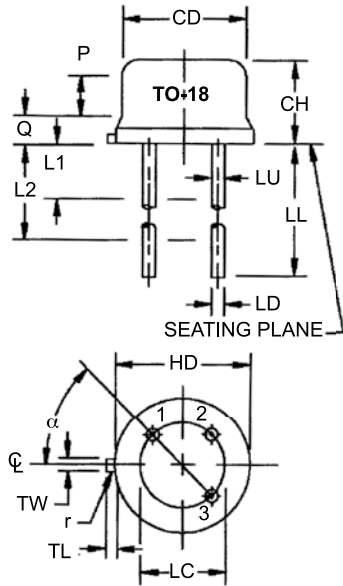

LTR	Dimensions			
	Inches		Millimeters	
	MIN	MAX	MIN	MAX
CD	.178	.195	4.52	4.95
CH	.170	.210	4.32	5.33
HD	.209	.230	5.31	5.84
LC	.100 TP		2.54 TP	
LD	.016	.019	.041	.048
LL	.500	.750	12.70	19.05
LU	.016	.019	.041	.048
L1		.050		1.27
L2	.250		6.35	
P	.100		2.54	
Q		.030		0.76
TL	.028	.048	0.71	1.22
TW	.036	.046	0.91	1.17
r		.010		0.25
α	45° TP		45° TP	
	1, 2, 9, 11, 13			

TO-5, TO-39

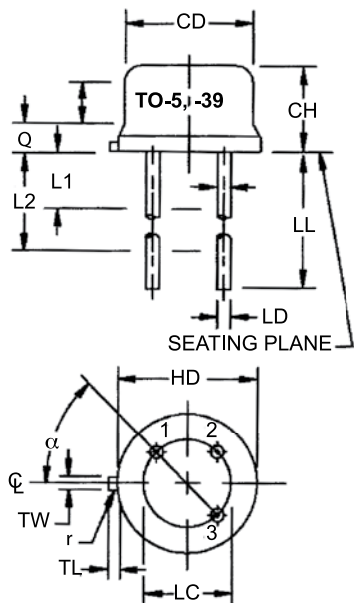

LTR	Dimensions			
	Inches		Millimeters	
	MIN	MAX	MIN	MAX
CD	.305	.335	7.75	8.51
CH	.240	.260	6.10	6.60
HD	.335	.370	8.51	9.40
LC	.200 TP		5.08 TP	
LD	.016	.019	.041	.048
LL	.500	.750	12.7	19.05
LU	.016	.019	.041	.048
L1		.050		1.27
L2	.250		6.35	
P	.100		2.54	
Q		.030		0.76
TL	.029	.045	0.74	1.14
TW	.028	.034	0.71	0.86
r		.010		0.25
α	45° TP		45° TP	
	1, 2, 10, 12, 13, 14			

TO-5 LL dimension shall be 1.5 inches max (38.1 mm) minimum and 1.75 inches (44.4 mm) maximum

TO-66

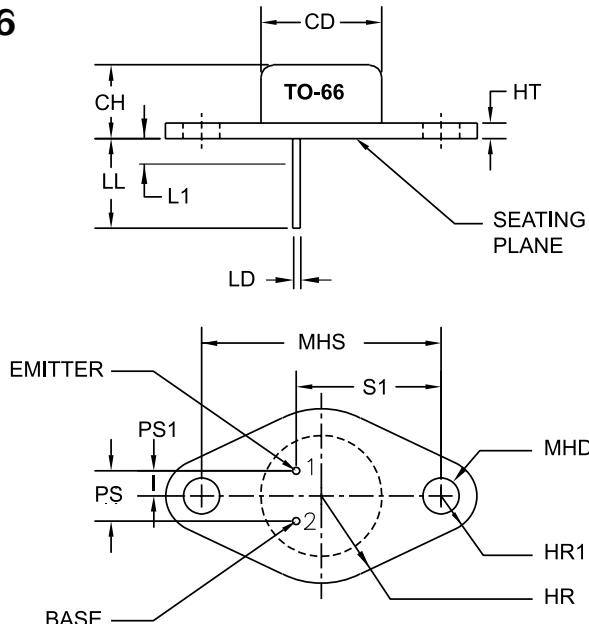

LTR	Dimensions			
	Inches		Millimeters	
	MIN	MAX	MIN	MAX
CD		.875		15.75
CH	.250	.340	6.35	8.64
HT	.050	.075	1.27	1.91
HR		.350		8.89
HR1	.115	.145	2.92	3.68
LD	.028	.034	0.71	0.86
LL	.360	.500	9.14	12.70
L1		.050		1.27
MHD	.142	.152	3.61	3.86
MHS	.958	.962	24.33	24.43
PS	.190	.210	4.83	5.33
PS1	.095	.105	2.41	2.66
S1	.570	.590	14.48	14.99

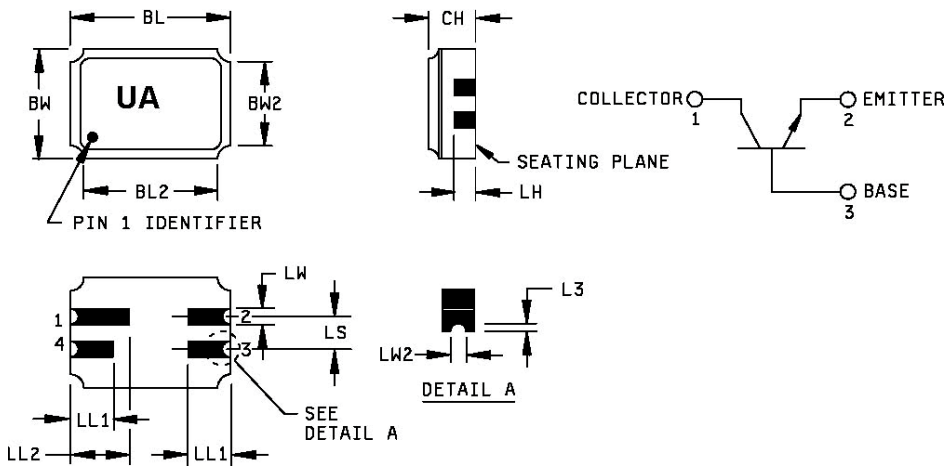

UA

Symbol	Dimensions			
	Inches		Millimeters	
	Min	Max	Min	Max
BL	.215	.225	5.46	5.71
BL2		.225		5.71
BW	.145	.155	3.68	3.93
BW2		.155		3.93
CH	.061	.075	1.55	1.90
L3	.003	.007	0.08	0.18
LH	.029	.042	0.74	1.07
LL1	.032	.048	0.81	1.22
LL2	.072	.088	1.83	2.23
LS	.045	.055	1.14	1.39
LW	.022	.028	0.56	0.71
LW2	.006	.022	0.15	0.56

Pin no.	1	2	3	4
Transistor	Collector	Emitter	Base	N/C

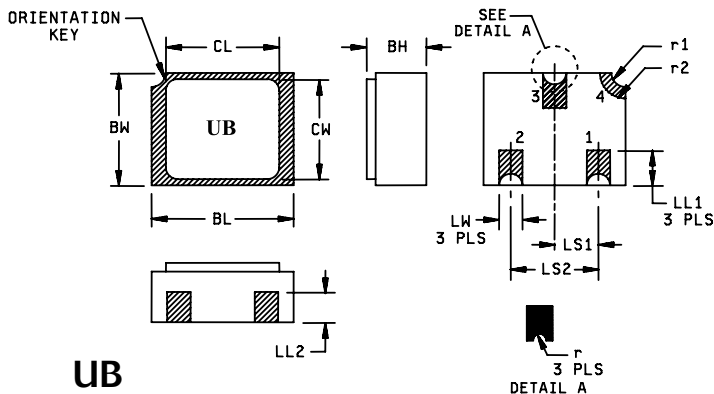

UB

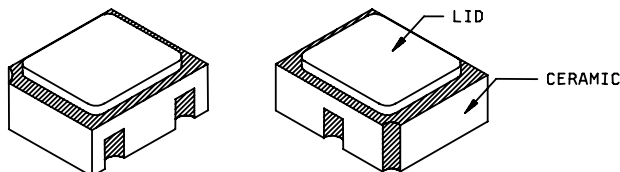

Symbol	Dimensions			
	Inches		Millimeters	
	Min	Max	Min	Max
BH	.046	.056	1.17	1.42
BL	.115	.128	2.92	3.25
BW	.085	.108	2.16	2.74
CL		.128		3.25
CW		.108		2.74
LL1	.022	.038	0.56	0.96
LL2	.017	.035	0.43	0.89
LS ₁	.036	.040	0.91	1.02
LS ₂	.071	.079	1.81	2.01
LW	.016	.024	0.41	0.61
r		.008		.203
r ₁		.012		.305
r ₂		.022		.559

Product Portfolio:

- Current offerings include Switching, TC Zeners, Zener Diodes, Current Regulators, Transistors and JANHC, JANKC Chips
- Qualifications coming for Schottkys, RadHard Transistors, Ultra Fast Rectifiers and 1.5W and 5W Zeners
- Class H and K Element Evaluation
- Test Lab Services

Certifications:

- JANS Certified Diode and Transistor manufacturing lines per MIL-PRF-19500
- MIL-STD-750 Lab Suitability Status
- ISO9001-2008 Certified

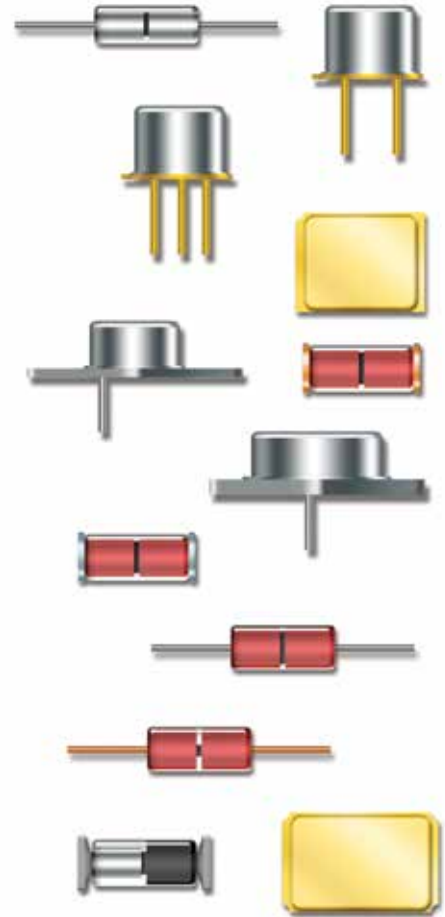



Our passion for performance is defined by three attributes represented by these three icons: solution-minded, performance-driven and customer-focused.

WEB SITE www.aeroflex.com/MetelicsHRC
 TELEPHONE 1-888-641-7364
 E-MAIL metelics-sales@aeroflex.com

Part No. SFM 10-2014
 Specifications are subject to change without notice.

Looking for pricing, stock, or lifecycle information?

Click below to explore more details on WIN SOURCE:

-  [View JANTX1N755AUR-1 on WIN SOURCE](#)
-  [M/A-Com Technology Solutions](#) Information

Optimize Your Supply Chain with WIN SOURCE Solutions

-  Global Sourcing Solution
-  Obsolete Management
-  Cost Control Management
-  Shortage Management
-  Alternative Solution
-  Excess Inventory Management