



**THE DATASHEET OF
JANTX1N5556**



**1500 WATT UNIDIRECTIONAL
 TRANSIENT VOLTAGE SUPPRESSOR**
Qualified per MIL-PRF-19500/500

DEVICES

1N5555	1N5556
1N5557	1N5558

LEVELS
JAN
JANTX
JANTXV

DESCRIPTION

This Transient Voltage Suppressor (TVS) series for 1N5555 thru 1N5558 are JEDEC registered selections for unidirectional devices. All have the same high Peak Pulse Power rating of 1500 W with extremely fast response times. They are also available in military qualified selections as described in the Features section herein. They are most often used for protecting against transients from inductive switching environments, induced RF effects, or induced secondary lightning effects as found in lower surge levels of IEC61000-4-5. They are also very successful in protecting airborne avionics and electrical systems. Since their response time is virtually instantaneous, they can also protect from ESD and EFT per IEC61000-4-2 and IEC61000-4-4.

IMPORTANT: For the most current data, consult *MICROSEMI's* website:

<http://www.microsemi.com>



FEATURES

- Unidirectional TVS series for thru-hole mounting
- Working voltage (V_{WM}) range 30.5 V to 175 V
- Hermetic sealed DO-13 metal package
- JAN/TX/TXV military qualifications also available per MIL-PRF-19500/500 by adding the JAN, JANTX, or JANTXV prefix, e.g. JANTXV1N5555, etc.
- For bidirectional TVS in the same DO-13 package, see separate data sheet for the 1N6036 – 1N6072A series (also military qualified)
- Surface mount equivalent packages also available from the SMCJ5.0 - SMCJ170CA or SMCG5.0 – SMCG170C series in separate data sheet (consult factory for other surface mount options)
- Plastic axial-leaded equivalents available from the 1N6267 – 1N6303A series in separate data sheet

DO-13 (DO-202AA)

APPLICATIONS / BENEFITS

- Suppresses transients up to 1500 watts @ 10/1000 μ s (see Figure 1)
- Clamps transient in less than 100 pico seconds
- Protection from switching transients and induced RF
- Protection from ESD and EFT per IEC 61000-4-2 and IEC 61000-4-4
- Secondary lightning protection per IEC61000-4-5 with 42 Ohms source impedance:
 - Class 1: 1N5555 to 1N5558
 - Class 2 & 3: 1N5555 to 1N5557
 - Class 4: 1N5555 to 1N5556
- Secondary lightning protection per IEC61000-4-5 with 12 Ohms source impedance:
 - Class 1: 1N5555 to 1N5557
 - Class 2: 1N5555 to 1N5557
- Inherently radiation hard as described in Microsemi MicroNote 050

MAXIMUM RATINGS

- 1500 Watts for 10/1000 μ s with repetition rate of 0.01% or less* at lead temperature (T_L) 25°C (see Figs 1, 2, & 4)
- Operating & Storage Temperatures: -65° to +175°C
- THERMAL RESISTANCE: 50°C/W junction to lead at 0.375 inches (10 mm) from body or 110°C/W junction to ambient when mounted on FR4 PC board with 4 mm² copper pads (1oz) and track width 1 mm, length 25 mm
- DC Power Dissipation*: 1 Watt at $T_L = +25^\circ\text{C}$ 3/8" (10 mm) from body (see derating in Fig 3)
- Forward surge current: 200 Amps for 8.3ms half-sine wave at $T_A = +25^\circ\text{C}$
- Solder Temperatures: 260 ° C for 10 s (maximum)

MECHANICAL AND PACKAGING

- CASE: DO-13 (DO-202AA), welded, hermetically sealed metal and glass
- FINISH: All external metal surfaces are Tin-Lead plated and solderable per MIL-STD-750 method 2026
- POLARITY: Cathode connected to case and polarity indicated by diode symbol
- MARKING: Part number and polarity diode symbol
- WEIGHT: 1.4 grams. (Approx)
- TAPE & REEL option: Standard per EIA-296 (add "TR" suffix to part number)
- See package dimension on last page

* TVS devices are not typically used for dc power dissipation and are instead operated at or less than their rated standoff voltage (V_{WM}) except for transients that briefly drive the device into avalanche breakdown (V_{BR} to V_C region).

ELECTRICAL CHARACTERISTICS

JEDEC Type Number (Notes 1&2)	Minimum Breakdown Voltage $V_{(BR)}$ @ $I_{(BR)}$	Test Current $I_{(BR)}$	Rated Standoff Voltage V_{WM}	Maximum (RMS) Reverse Voltage $V_{WM(RMS)}$	Maximum Standby Current I_D @ V_{WM}	Maximum Peak Reverse Voltage V_C @ I_{PP}	Maximum Peak Pulse Current I_{PP}	Maximum Temperature Coefficient of $V_{(BR)}$ $\alpha_{V(BR)}$ @ 1.0 mA
	V	mA	V	V	μ A	V	A	%/°C
1N5555	33.0	1.0	30.5	21.5	5	47.5	32	+0.93
1N5556	43.7	1.0	40.3	28.5	5	63.5	24	+0.94
1N5557	54.0	1.0	49.0	34.5	5	78.5	19	+0.96
1N5558	191.0	1.0	175.0	124.0	5	265.0	5.7	+1.00

NOTE 1: A TVS is normally selected according to the rated “Standoff Voltage” V_{WM} that should be equal to or greater than the dc or continuous peak operating voltage level.

NOTE 2: Also available in military qualified types with a JAN, JANTX, or JANTXV prefix.

SYMBOLS & DEFINITIONS

Symbol	Definition
V_{WM}	Standoff Voltage: Applied Reverse Voltage to assure a nonconductive condition. (See Note 1 above.)
$V_{(BR)}$	Breakdown Voltage: This is the Breakdown Voltage the device will exhibit at 25°C
V_C	Maximum Clamping Voltage: The maximum peak voltage appearing across the TVS when subjected to the peak pulse current in a one millisecond time interval. The peak pulse voltage is the combination of voltage rise due to both the series resistance and thermal rise and positive temperature coefficient ($\alpha_{V(BR)}$)
I_{PP}	Peak Pulse Current: The peak current during the impulse (See Figure 2)
P_{PP}	Peak Pulse Power: The pulse power as determined by the product of V_C and I_{PP}
I_D	Standby Current: The current at the standoff voltage (V_{WM})
$I_{(BR)}$	Breakdown Current: The current used for measuring Breakdown Voltage ($V_{(BR)}$)

GRAPHS

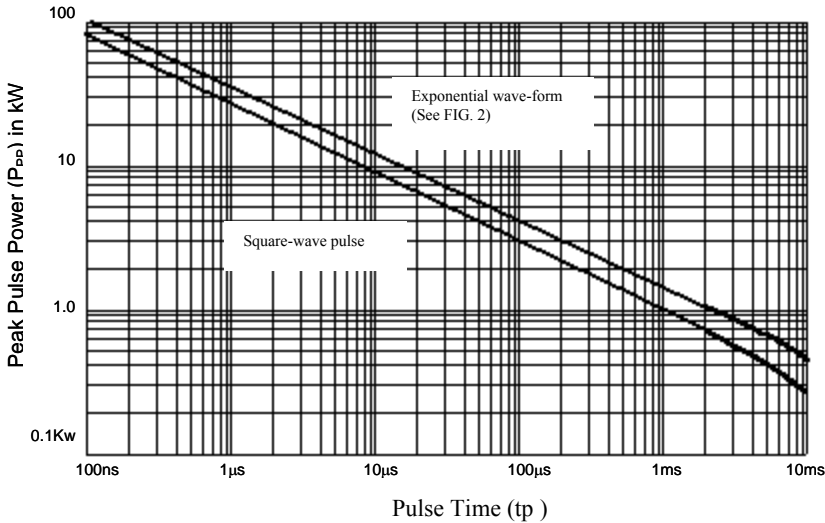

FIG. 1 – Non-repetitive peak pulse power rating curve
 NOTE: Peak power defined as peak voltage times peak current

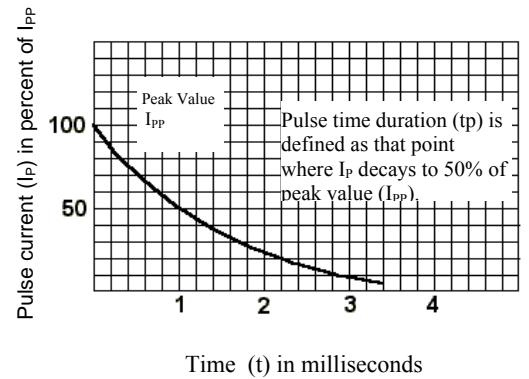

FIG. 2 Pulse wave form for exponential surge

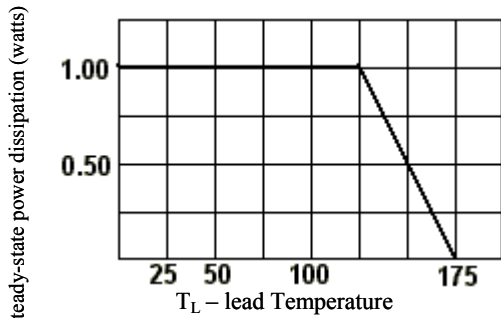

FIG. 3 Steady-state power derating curve

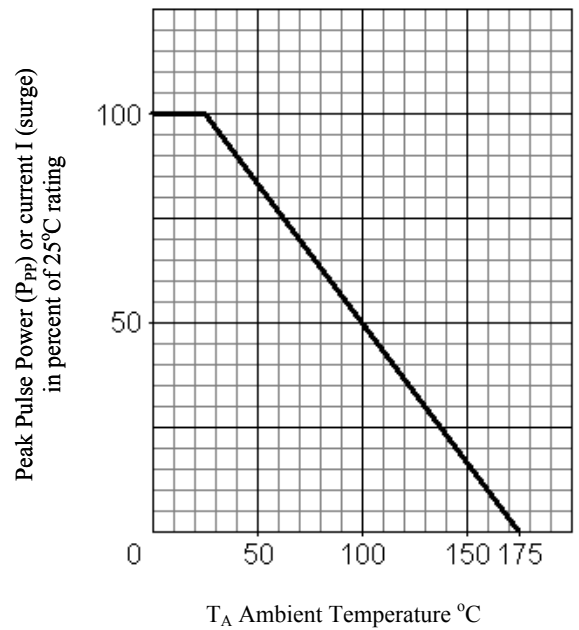
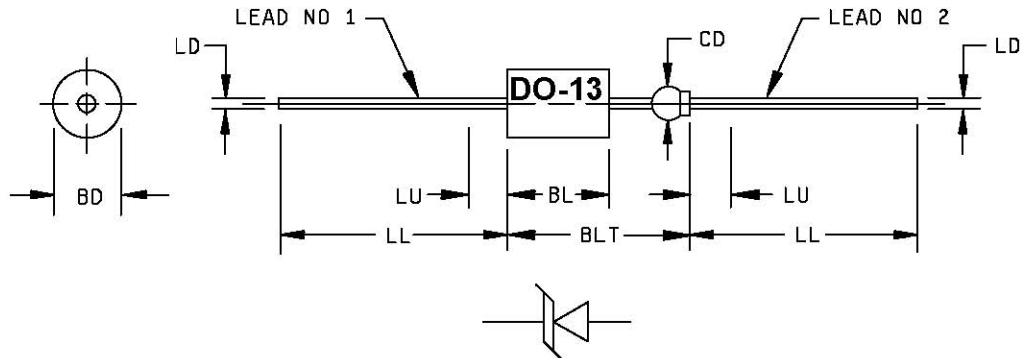

FIG. 4 Derating Curve

PACKAGE DIMENSIONS



NOTES:



1. Dimensions are in inches.
2. Millimeters are given for general information only.
3. The major diameter is essentially constant along its length.
4. Within this zone, diameter may vary to allow for lead finishes and irregularities.
5. Dimension to allow for pinch or seal deformation anywhere along tubulation.
6. Lead 1 (cathode) shall be electrically connected to the case.
7. In accordance with ASME Y14.5M, diameters are equivalent to ϕ x symbology.

Symbol	Dimensions				Notes
	Inches		Millimeters		
	Min	Max	Min	Max	
BD	.215	.235	5.46	5.97	
BL	.293	.357	7.44	9.07	3
BLT		.570		14.48	
CD	.045	.100	1.14	2.54	5
LD	.025	.035	0.64	0.89	
LL	1.000	1.625	25.40	41.28	4
LU		.188		4.78	4

FIGURE 1. Physical dimensions (DO-13).

Looking for pricing, stock, or lifecycle information?

Click below to explore more details on WIN SOURCE:

-  [View JANTX1N5556 on WIN SOURCE](#)
-  [Microchip Technology](#) Information

Optimize Your Supply Chain with WIN SOURCE Solutions

-  Global Sourcing Solution
-  Obsolete Management
-  Cost Control Management
-  Shortage Management
-  Alternative Solution
-  Excess Inventory Management