



# ISL8205M

## 5A Single Channel High Efficiency DC/DC Step-Down Power Module

The [ISL8205M](#) power module is a single channel synchronous step-down complete power supply, capable of delivering up to 5A of continuous current. Operating from a single 2.6V to 5.5V input power rail and integrating controller, power inductor and MOSFETs, the ISL8205M only requires a few external components to operate and is optimized for space constrained and portable battery operated applications.

Based on current mode PWM control scheme, the ISL8205M provides a fast transient response and excellent loop stability as well as a very low duty cycle with an adjustable output voltage as low as 0.6V and better than 1.6% accuracy over line and load conditions. Operation frequency is selectable through an external resistor, with a 1.8MHz default setting, or may be synchronized with an external clock signal up to 3.5MHz. The ISL8205M also implements a selectable PFM mode to improve light-load efficiency and a 100% duty cycle LDO mode to extend battery life. A programmable soft-start reduces the inrush current required from the input supply while an automatic output discharge ensures a soft stop. Dedicated enable pin and power-good flag allow for easy system power rails sequencing.

An array of protection features, including input Undervoltage Lockout (UVLO), over-temperature, overcurrent/short-circuit with hiccup mode, overvoltage and negative overcurrent, guarantees safe operations under abnormal operating conditions.

The ISL8205M is available in a compact RoHS compliant with exemption 7C-I 22 Ld 4.5x7.5x1.85mm QFN package.

## Features

- 5A single channel complete power supply
  - Integrates controller, MOSFETs and inductor
  - Pin/function compatible with the 3A [ISL8202M](#)
- 2.6V to 5.5V input voltage range
- Adjustable output voltage range
  - As low as 0.6V with  $\pm 1.6\%$  accuracy over line/load/temperature
  - Up to 95% efficiency
- Default 1.8MHz current mode control operations
  - 680kHz to 3.5MHz resistor adjustable
  - External synchronization up to 3.5MHz
  - Selectable light-load efficiency mode
  - 100% duty cycle LDO mode
- Programmable soft-start
- Soft-stop output discharge
- Dedicated enable pin and power-good flag
- UVLO, over-temperature, overcurrent, overvoltage and negative overcurrent protections
  - Overcurrent/short-circuit hiccup mode
- 4.5mmx7.5mmx1.85mm 22 Ld QFN package

## Applications

- DC to DC POL power module
- $\mu\text{C}/\mu\text{P}$ , FPGA and DSP power
- Portable equipment
- Battery operated equipment

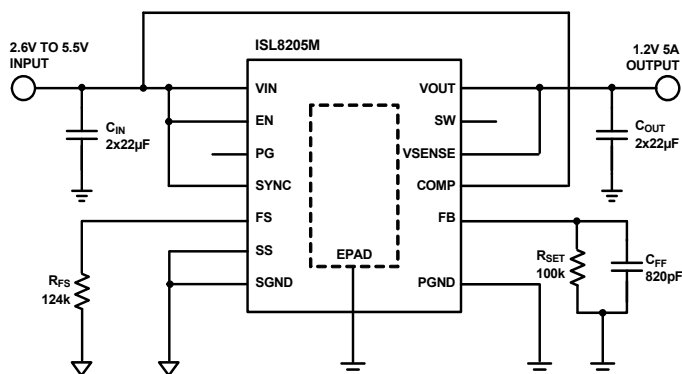

FIGURE 1. TYPICAL APPLICATION DIAGRAM AT  $5V_{IN}$ ,  $1.2V_{OUT}$ ,  $1.6\text{MHz } f_{SW}$ , 5A

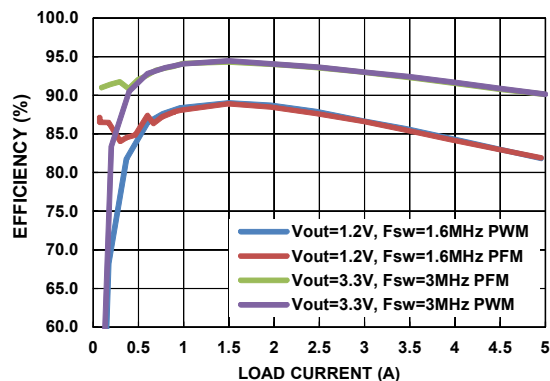

FIGURE 2. EFFICIENCY vs LOAD  $5V_{IN}$

# Table of Contents

<b>Functional Block Diagram</b> .....	<b>3</b>
<b>Pin Configuration</b> .....	<b>4</b>
<b>Pin Descriptions</b> .....	<b>4</b>
<b>Ordering Information</b> .....	<b>5</b>
<b>Absolute Maximum Ratings</b> .....	<b>6</b>
<b>Thermal Information</b> .....	<b>6</b>
<b>Recommended Operating Conditions</b> .....	<b>6</b>
<b>Electrical Specifications</b> .....	<b>6</b>
<b>Typical Performance Characteristics</b> .....	<b>9</b>
Efficiency .....	9
Output Voltage Ripple .....	9
Load Transient Response .....	10
Start-Up .....	11
Short-Circuit Protection .....	12
Overvoltage Protection .....	13
Power Loss .....	13
Derating .....	13
<b>Functional Description</b> .....	<b>15</b>
PWM Control Scheme .....	15
PFM (Skip) Mode .....	15
Frequency Adjust .....	15
Overcurrent Protection .....	15
Negative Current Protection .....	16
Power-Good .....	16
UVLO .....	16
Soft Start-Up .....	16
External Synchronization Control .....	16
Enable .....	16
Discharge Mode (Soft-Stop) .....	16
100% Duty Cycle .....	16
Thermal Shutdown .....	16
<b>Applications Information</b> .....	<b>16</b>
Programming the Output Voltage .....	16
Recommended Switching Frequency .....	17
Input Capacitor Selection .....	17
Output Capacitor Selection .....	17
Feed-Forward Capacitor Selection .....	17
Typical Application Circuit .....	18
Thermal Consideration and Current Derating .....	18
<b>PCB Layout Recommendations</b> .....	<b>19</b>
Package Description .....	20
PCB Layout Pattern Design .....	20
Thermal Vias .....	20
Stencil Pattern Design .....	20
Reflow Parameters .....	20
<b>Revision History</b> .....	<b>21</b>

# Functional Block Diagram

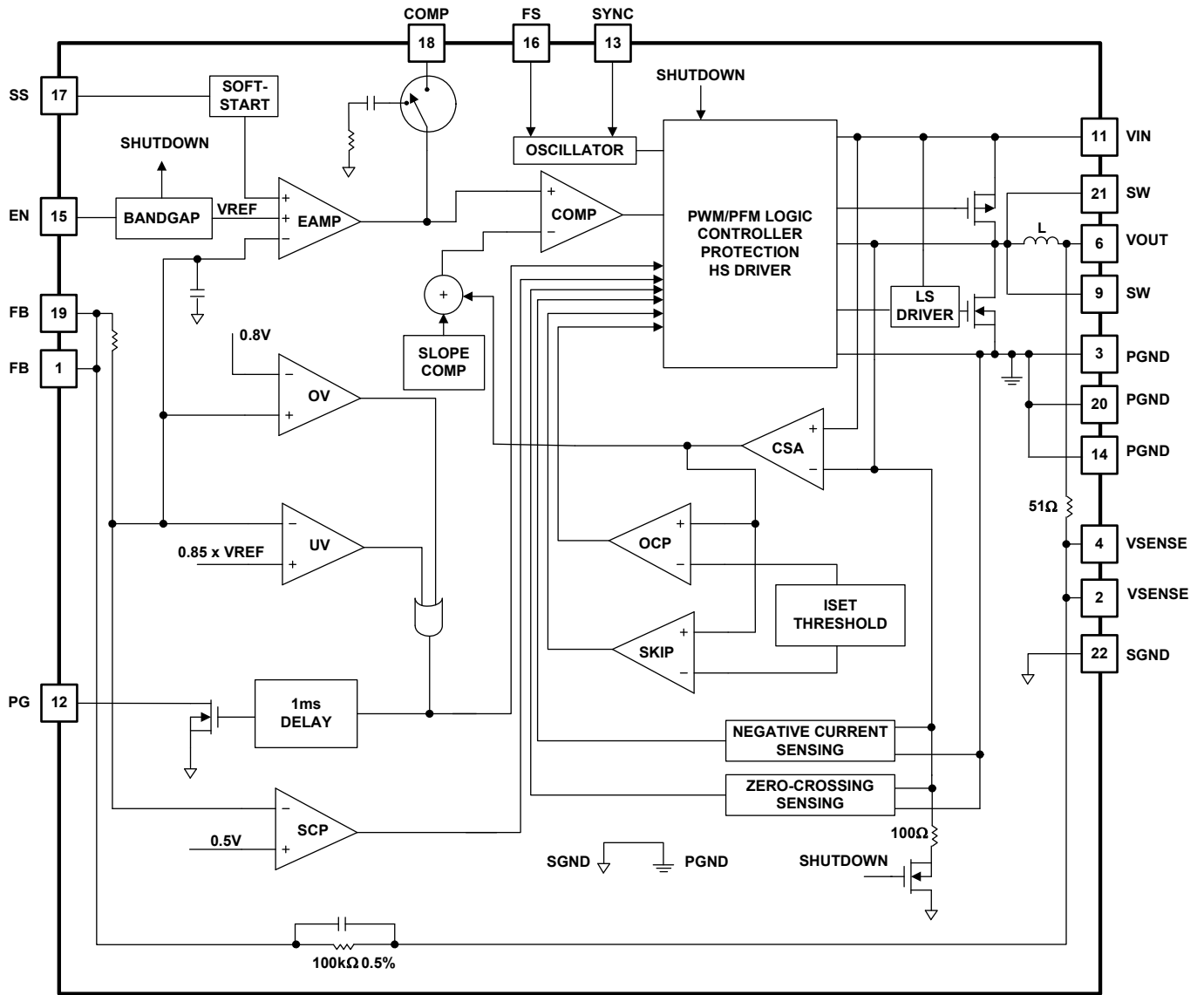
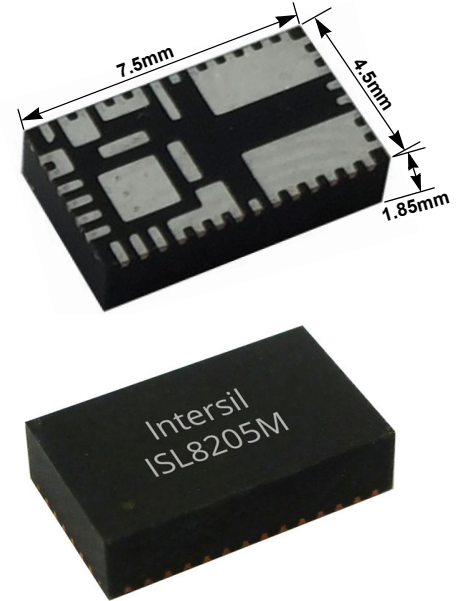
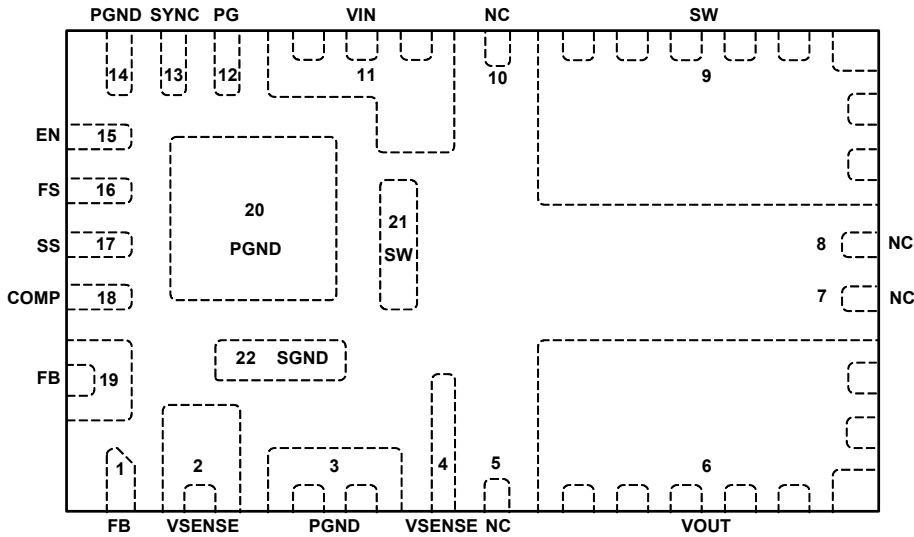

FIGURE 3. FUNCTIONAL BLOCK DIAGRAM

## Pin Configuration

(22 LD QFN)  
TOP VIEW



## Pin Descriptions

PIN NUMBER	PIN NAME	DESCRIPTION
1, 19	FB	<b>Voltage setting pin.</b> Module output voltage is set by connecting a resistor, $R_{SET}$ , from this pin to SGND. A ceramic capacitor is also recommended to be placed in parallel with $R_{SET}$ from FB to SGND to ensure system stability in extreme operation conditions. Refer to <a href="#">Table 2 on page 14</a> for the resistor and capacitor values for various typical output voltage.
2, 4	VSENSE	<b>Voltage sense pin.</b> Pins 2 and 4 are shorted together internally. An internal $51\Omega$ resistor is connected from VOUT (Pad 6) to VSENSE for local output voltage feedback in case remote sensing is not present. To achieve best regulation performance at point of load, remote sensing trace needs to be directly routed to VSENSE.
3, 14	PGND	<b>Power ground.</b> Power ground pins. Place output capacitor across VOUT and PGND close to Pin 3 since it is the return path for output current.
5, 7, 8, 10	NC	<b>No connection pins.</b> These pins have no connections inside. Leave these pins floating.
6	VOUT	<b>Power output.</b> Power output of the module. Output capacitors should be placed across this pad and Pin 3 PGND and close to the module. Apply load between this pin and PGND Pin 3. Output voltage range: 0.6V to 5V.
9, 21	SW	<b>Switching node.</b> These pins can be used to monitor switch node waveform to examine switching frequency. These pins can also be used for snubber connection. To improve system efficiency, it is recommended to connect Pins 9 and 21 with wide copper shape. However, avoid connecting SW to large copper shape to minimize radiated EMI noise.
11	VIN	<b>Power input.</b> Input voltage range: 2.6V to 5.5V. Tie directly to the input rail. It is required to have a minimum total input capacitance of $44\mu\text{F}$ at module input. Add additional capacitance if possible. Use X5R or X7R ceramic capacitors. It is critical to place input ceramic capacitors as close as possible to module input. Refer to <a href="#">"PCB Layout Recommendations" on page 19</a> for more information.
12	PG	<b>Power-good pin.</b> Power-good is an open-drain output. Use a $10\text{k}\Omega$ to $100\text{k}\Omega$ pull-up resistor connected between VIN and PG. During power-up or EN pin start-up, PG rising edge is delayed by $1\text{ms}$ upon output reached within regulation.
13	SYNC	<b>Synchronization pin.</b> Mode selection pin. Connect to logic high or input voltage VIN for PWM mode. Connect to logic low or ground for PFM mode. Connect to an external clock for synchronization with the positive edge trigger. There is an internal $1\text{M}\Omega$ pull-down resistor to prevent an undefined logic state in case SYNC pin is floating. Therefore, PFM mode is enabled when SYNC is left floating.
15	EN	<b>Power enable pin.</b> Enables the output, when driven high. Shuts down the output and discharges the output capacitor when driven low. Typically tie to VIN pin directly. Do not leave this pin floating.

## Pin Descriptions (Continued)

PIN NUMBER	PIN NAME	DESCRIPTION
16	FS	<b>Frequency selection pin.</b> This pin sets the module switching frequency. The default frequency is 1.8MHz if FS is connected to VIN. In spite of default setting, a resistor, $R_{FS}$ , can be connected from the FS pin to SGND to adjust switching frequency ranging from 680kHz to 3.5MHz.
17	SS	<b>Soft-start pin.</b> SS is used to adjust the soft-start time. Connect to SGND for internal 1ms rise time. Connect a capacitor from SS to SGND to adjust the soft-start time. The capacitor value should be less than 33nF to ensure proper operation.
18	COMP	<b>Compensation pin.</b> COMP is the output of the voltage feedback error amplifier. For most applications, the internal compensation network can be used to stabilize the system and achieve optimal transient response. This can be done by directly connecting COMP to VIN. For other applications where external compensation is desired, COMP needs to be disconnected from VIN and tied to the external compensation network.
Exposed Pad 20	PGND	The exposed pad is connected internally to PGND. Solid connection should be made between Pad 20 and PGND plane on PCB. Place as many vias as possible under the pad connecting to PGND plane(s) for optimal electrical and thermal performance. Refer to " <a href="#">PCB Layout Recommendations</a> " on <a href="#">page 19</a> for more information.
22	SGND	<b>Signal ground pin.</b> Connect PCB SGND plane to this pin. Internally, this pin is single-point connected to module PGND.

## Ordering Information

PART NUMBER (Notes 2, 3)	PART MARKING	PACKAGE DESCRIPTION (RoHS COMPLIANT)	PKG. DWG. #	CARRIER TYPE (Note 1)	TEMP. RANGE
ISL8205MIRZ	ISL8205M	22 Ld QFN	L22.4.5x7.5	Tray	-40 to +85 °C
ISL8205MIRZ-T				Reel, 3k	
ISL8205MIRZ-T7A				Reel, 250	
ISL8205MEVAL1Z	Evaluation Board				

### NOTES:

- See [TB347](#) for details about reel specifications.
- This product is in compliance with EU Directive 2015/863/EU amending Annex II to EU Directive 2011/65/EU (RoHS) and contains Pb according to RoHS exemption 7c-i, Pb in a glass or ceramic other than dielectric ceramic in capacitors. These plastic packaged products use 100% matte tin plate plus anneal (e3) termination finish, which is compatible with both SnPb and Pb-free soldering operations. RoHS compliant products are MSL classified at Pb-free peak reflow temperatures that meet or exceed the Pb-free requirements of IPC/JEDEC J-STD-020.
- For Moisture Sensitivity Level (MSL), please see product information page for [ISL8205M](#). For more information on MSL, see [TB363](#).

TABLE 1. KEY DIFFERENCES BETWEEN FAMILY OF PARTS

PART NUMBER	MAX OUTPUT CURRENT $I_{OUT}$ (DC)
ISL8205M	5A
ISL8203M	3A dual, 6A single
ISL8202M	3A

**Absolute Maximum Ratings** (Reference to GND)

V <sub>IN</sub> .....	-0.3V to 5.8V (DC) or 7V (20ms)
EN, FS, PG, SYNC, VFB .....	-0.3V (DC) to V <sub>IN</sub> +0.3V
SW .....	-1.5V (100ns)/-0.3V (DC) to 6.5V (DC) or 7V (20ms)
COMP, SS (Note 6) .....	-0.3V to 2.7V
<b>ESD Ratings</b>	
Human Body Model (Tested per JS-001-2010) .....	2kV
Charged Device Model (Tested per JS-002-2014) .....	750V
Machine Model (Tested per JESD22-A115C) .....	200V
Latch-Up (Tested per JESD-78D; Class 2, Level A) .....	100mA at +85°C

**Thermal Information**

Thermal Resistance (Typical)	$\theta_{JA}$ (°C/W)	$\theta_{JC}$ (°C/W)
22 Ld QFN (Notes 4, 5) .....	27.4	4.8
Junction Temperature Range .....	-55°C to +125°C	
Storage Temperature Range .....	-65°C to +150°C	
Pb-Free Reflow Profile .....	see <a href="#">TB493</a>	

**Recommended Operating Conditions**

V <sub>IN</sub> Supply Voltage Range .....	2.6V to 5.5V
V <sub>OUT</sub> Voltage Range .....	0.6V to 5V
Load Current Range .....	0A to 5A
Ambient Temperature Range .....	-40°C to +85°C

**CAUTION:** Do not operate at or near the maximum ratings listed for extended periods of time. Exposure to such conditions may adversely impact product reliability and result in failures not covered by warranty.

**NOTES:**

- $\theta_{JA}$  is measured in free air with the component mounted on the ISL8205MEVAL1Z evaluation board with "direct attach" features. Refer to [ISL8205MEVAL1Z User Guide](#) for evaluation board details. Also see [TB379](#) for general thermal metric information.
- For  $\theta_{JC}$ , "case temperature" location is at the center of the exposed metal pad on the package underside.
- COMP is an input and output pin. When the ISL8205M is used with an internal compensation, the COMP pin has a rating similar to V<sub>IN</sub>. When using the ISL8205M with an external compensation, the ratings are -0.3V to 2.7V.

**Electrical Specifications** Unless otherwise noted, typical specifications are measured at V<sub>IN</sub> = 3.6V, V<sub>OUT</sub> = 1.2V, T<sub>A</sub> = +25°C.

**Boldface limits apply across the operating temperature range, -40°C to +85°C.**

PARAMETER	SYMBOL	TEST CONDITIONS	MIN (Note 7)	TYP	MAX (Note 7)	UNIT
<b>INPUT SUPPLY</b>						
V <sub>IN</sub> Undervoltage Lockout Threshold (Note 8)	V <sub>UVLO</sub>	Rising, no load		2.3	<b>2.5</b>	V
		Falling, no load	<b>2.10</b>	2.25		V
Quiescent Supply Current	I <sub>VIN</sub>	SYNC = GND, EN = high, I <sub>OUT</sub> = 0A		50		μA
		SYNC = V <sub>IN</sub> , f <sub>SW</sub> = 1.6MHz, EN = high, I <sub>OUT</sub> = 0A		18	<b>24</b>	mA
Shutdown Supply Current	I <sub>SD</sub>	SYNC = GND, V <sub>IN</sub> = 5.5V, EN = low		5	<b>20</b>	μA
<b>OUTPUT REGULATION</b>						
Output Continuous Current Range	I <sub>OUT(DC)</sub>				<b>5</b>	A
Line Regulation	$\Delta V_{OUT}/V_{OUT}$	V <sub>IN</sub> = 2.6V to 5.5V, V <sub>OUT</sub> = 1.2V, f <sub>SW</sub> = 1.6MHz, I <sub>OUT</sub> = 0A, PWM mode		0.65		%
		V <sub>IN</sub> = 2.6V to 5.5V, V <sub>OUT</sub> = 1.2V, f <sub>SW</sub> = 1.6MHz, I <sub>OUT</sub> = 5A, PWM mode		0.46		%
Load Regulation		V <sub>IN</sub> = 5V, V <sub>OUT</sub> = 1.2V, f <sub>SW</sub> = 1.6MHz, I <sub>OUT</sub> = 0A to 5A, PWM mode		0.6		%
		V <sub>IN</sub> = 5V, V <sub>OUT</sub> = 3.3V, f <sub>SW</sub> = 3MHz, I <sub>OUT</sub> = 0A to 5A, PWM mode		0.62		%
Output Voltage Accuracy (Note 9)		Over line/load/temperature range, PWM mode, V <sub>OUT</sub> = 1.2V to 3.3V	<b>-1.6</b>		<b>1.6</b>	%
Output Ripple Voltage	$\Delta V_{OUT}$	V <sub>IN</sub> = 5V, 2x22μF ceramic output capacitor, PWM mode				
		I <sub>OUT</sub> = 0A, V <sub>OUT</sub> = 1.2V, f <sub>SW</sub> = 1.6MHz		11		mV <sub>P-P</sub>
		I <sub>OUT</sub> = 5A, V <sub>OUT</sub> = 1.2V, f <sub>SW</sub> = 1.6MHz		12		mV <sub>P-P</sub>
		I <sub>OUT</sub> = 0A, V <sub>OUT</sub> = 3.3V, f <sub>SW</sub> = 3MHz		8		mV <sub>P-P</sub>
		I <sub>OUT</sub> = 5A, V <sub>OUT</sub> = 3.3V, f <sub>SW</sub> = 3MHz		10		mV <sub>P-P</sub>

**Electrical Specifications** Unless otherwise noted, typical specifications are measured at  $V_{IN} = 3.6V$ ,  $V_{OUT} = 1.2V$ ,  $T_A = +25^\circ C$ .  
**Boldface limits apply across the operating temperature range,  $-40^\circ C$  to  $+85^\circ C$ . (Continued)**

PARAMETER	SYMBOL	TEST CONDITIONS	MIN (Note 7)	TYP	MAX (Note 7)	UNIT
Reference Voltage (Note 8)	$V_{REF}$		<b>0.594</b>	0.600	<b>0.606</b>	V
VFB Bias Current (Note 8)	$I_{FB}$	$V_{FB} = 0.75V$		0.1		$\mu A$
Soft-Start Ramp Time Cycle (Note 8)		SS = GND		1		ms
Soft-Start Charging Current (Note 8)	$I_{SS}$	$V_{SS} = 0.1V$	<b>1.45</b>	1.85	<b>2.25</b>	$\mu A$
<b>DYNAMIC CHARACTERISTICS</b>						
Voltage Change for Positive Load Step	$\Delta V_{OUT-DP}$	Current slew rate = $1A/\mu s$ , $V_{IN} = 5V$ , $2 \times 22\mu F$ ceramic output capacitor				
		$V_{OUT} = 1.2V$ , $I_{OUT} = 0A$ to $5A$ , $f_{SW} = 1.6MHz$		120		mV <sub>P-P</sub>
		$V_{OUT} = 3.3V$ , $I_{OUT} = 0A$ to $5A$ , $f_{SW} = 3MHz$		69		mV <sub>P-P</sub>
Voltage Change for Negative Load Step	$\Delta V_{OUT-DP}$	Current slew rate = $1A/\mu s$ , $V_{IN} = 5V$ , $2 \times 22\mu F$ ceramic output capacitor				
		$V_{OUT} = 1.2V$ , $I_{OUT} = 5A$ to $0A$ , $f_{SW} = 1.6MHz$		127		mV <sub>P-P</sub>
		$V_{OUT} = 3.3V$ , $I_{OUT} = 5A$ to $0A$ , $f_{SW} = 3MHz$		79		mV <sub>P-P</sub>
<b>OVERCURRENT PROTECTION (Note 8)</b>						
Current Limit Blanking Time	$t_{OCON}$			17		Clock pulses
Overcurrent and Auto Restart Period	$t_{OCCOFF}$			8		SS cycle
Positive Peak Overcurrent Limit	$I_{PLIMIT}$		<b>7.5</b>	9.0	<b>11.0</b>	A
Positive Skip Limit	$I_{SKIP}$		<b>1.0</b>	1.3	<b>1.8</b>	A
Zero Cross Threshold			<b>-300</b>		<b>300</b>	mA
Negative Current Limit	$I_{NLIMIT}$		<b>-4.5</b>	-3.0	<b>-1.5</b>	A
<b>COMPENSATION (Note 8)</b>						
Current Sensing Gain	$R_t$		<b>0.119</b>	0.140	<b>0.166</b>	$\Omega$
Error Amplifier Transconductance		Internal compensation		60		$\mu A/V$
		External compensation		120		$\mu A/V$
<b>SWITCH NODE (Note 8)</b>						
P-Channel MOSFET ON-Resistance		$V_{IN} = 5V$ , $I_O = 200mA$		36	<b>63</b>	m $\Omega$
		$V_{IN} = 2.7V$ , $I_O = 200mA$		52	<b>89</b>	m $\Omega$
N-Channel MOSFET ON-Resistance		$V_{IN} = 5V$ , $I_O = 200mA$		13	<b>30</b>	m $\Omega$
		$V_{IN} = 2.7V$ , $I_O = 200mA$		17	<b>36</b>	m $\Omega$
SW Maximum Duty Cycle				100		%
SW Minimum On-Time		SYNC = High			<b>115</b>	ns
<b>OSCILLATOR</b>						
Nominal Switching Frequency	$f_{SW}$	SYNC = $V_{IN}$	<b>1600</b>	1835	<b>2070</b>	kHz
		$f_{SW}$ with $R_{FS} = 261k\Omega$		800		kHz
		$f_{SW}$ with $R_{FS} = 124k\Omega$		1600		kHz
SYNC Logic LOW to HIGH Transition Range			<b>0.70</b>	0.75	<b>0.80</b>	V
SYNC Hysteresis				0.15		V
SYNC Logic Input Leakage Current		$V_{IN} = 3.6V$		3.6	<b>5.0</b>	$\mu A$

**Electrical Specifications** Unless otherwise noted, typical specifications are measured at  $V_{IN} = 3.6V$ ,  $V_{OUT} = 1.2V$ ,  $T_A = +25^\circ C$ .  
**Boldface limits apply across the operating temperature range,  $-40^\circ C$  to  $+85^\circ C$ . (Continued)**

PARAMETER	SYMBOL	TEST CONDITIONS	MIN (Note 7)	TYP	MAX (Note 7)	UNIT
<b>PG (Note 8)</b>						
Output Low Voltage					<b>0.3</b>	V
PG Pin Leakage Current		$PG = V_{IN}$		0.01	<b>0.10</b>	$\mu A$
OVP PG Rising Threshold				0.80		V
UVP PG Rising Threshold			<b>80</b>	85	<b>90</b>	%
UVP PG Hysteresis				30		mV
PGOOD Delay Time (Rising Edge)		Time from V <sub>OUT</sub> reaching regulation	<b>0.5</b>	1.0	<b>2.0</b>	ms
PGOOD Delay Time (Falling Edge)				7.5		$\mu s$
<b>EN (Note 8)</b>						
Logic Input Low					<b>0.4</b>	V
Logic Input High			<b>0.9</b>			V
Enable Logic Input Leakage Current		Pulled up to 3.6V		0.1	<b>1.0</b>	$\mu A$
Thermal Shutdown		Temperature Rising		150		$^\circ C$
Thermal Shutdown Hysteresis		Temperature Falling		25		$^\circ C$

## NOTES:

7. Compliance to datasheet limits is assured by one or more methods: production test, characterization and/or design.
8. Parameters with MIN and/or MAX limits are 100% tested for internal IC prior to module assembly, unless otherwise specified. Temperature limits established by characterization and are not production tested.
9. A 0.1% tolerance resistor is used for  $R_{SET}$ .

# Typical Performance Characteristics

## Efficiency $T_A = +25^\circ\text{C}$ .

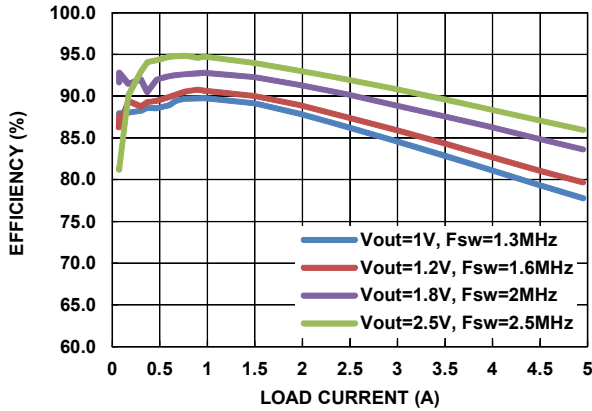

FIGURE 4. EFFICIENCY  $T_A = +25^\circ\text{C}$ ,  $V_{IN} = 3.3\text{V}$  PFM MODE

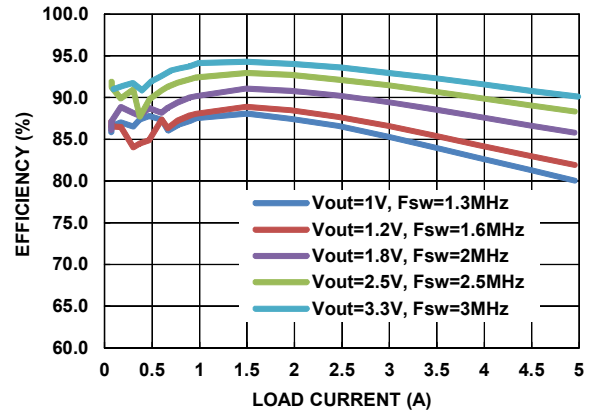

FIGURE 5. EFFICIENCY  $T_A = +25^\circ\text{C}$ ,  $V_{IN} = 5\text{V}$  PFM MODE

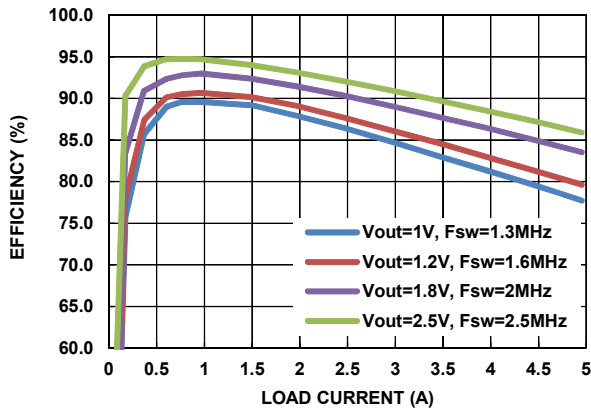

FIGURE 6. EFFICIENCY  $T_A = +25^\circ\text{C}$ ,  $V_{IN} = 3.3\text{V}$  PWM MODE

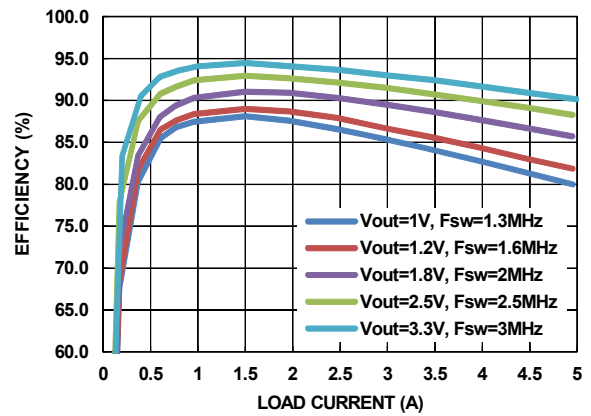

FIGURE 7. EFFICIENCY  $T_A = +25^\circ\text{C}$ ,  $V_{IN} = 5\text{V}$  PWM MODE

## Output Voltage Ripple $T_A = +25^\circ\text{C}$ .

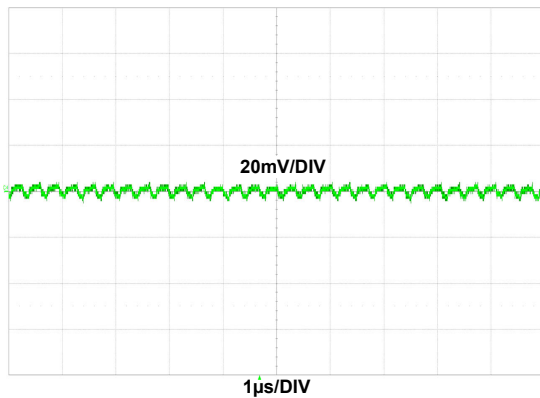

FIGURE 8.  $V_{IN} = 5\text{V}$ ,  $V_{OUT} = 3.3\text{V}$ ,  $I_{OUT} = 0\text{A}$ ,  $f_{SW} = 3\text{MHz}$ ,  $C_{OUT} = 2 \times 22\mu\text{F}$  CERAMIC CAPACITORS

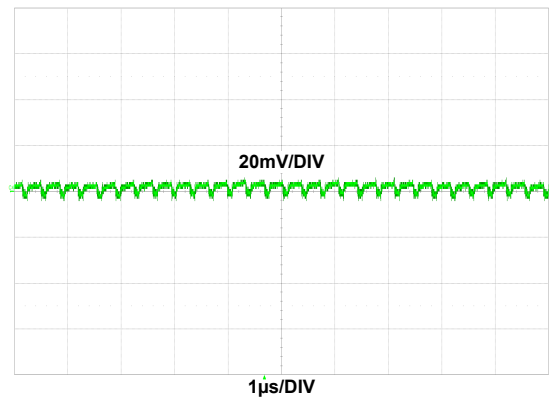

FIGURE 9.  $V_{IN} = 5\text{V}$ ,  $V_{OUT} = 3.3\text{V}$ ,  $I_{OUT} = 5\text{A}$ ,  $f_{SW} = 3\text{MHz}$ ,  $C_{OUT} = 2 \times 22\mu\text{F}$  CERAMIC CAPACITORS

## Typical Performance Characteristics (Continued)

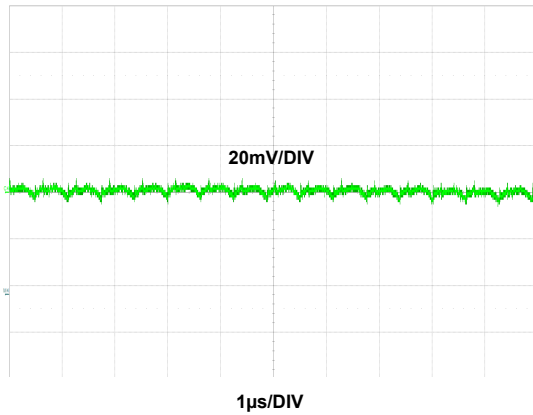

FIGURE 10.  $V_{IN} = 5V$ ,  $V_{OUT} = 1.2V$ ,  $I_{OUT} = 0A$ ,  $f_{SW} = 1.6MHz$ ,  $C_{OUT} = 2 \times 22\mu F$  CERAMIC CAPACITORS

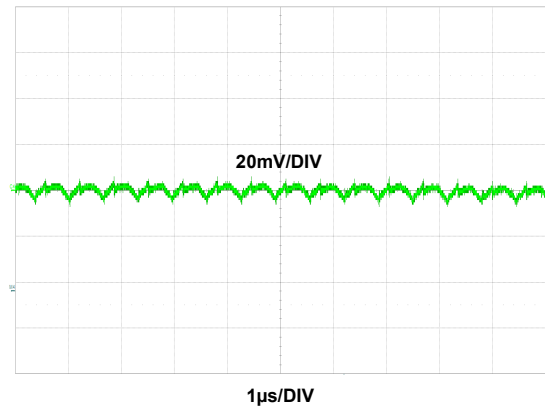

FIGURE 11.  $V_{IN} = 5V$ ,  $V_{OUT} = 1.2V$ ,  $I_{OUT} = 5A$ ,  $f_{SW} = 1.6MHz$ ,  $C_{OUT} = 2 \times 22\mu F$  CERAMIC CAPACITORS

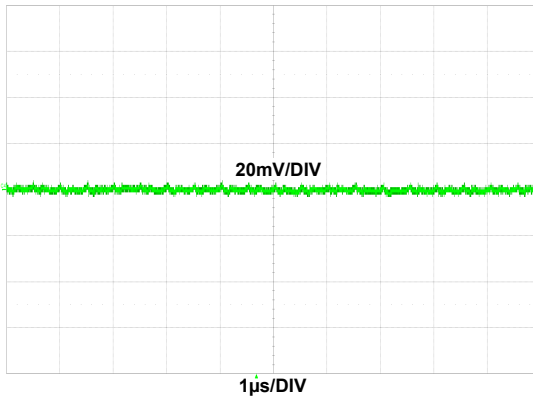

FIGURE 12.  $V_{IN} = 3.3V$ ,  $V_{OUT} = 2.5V$ ,  $I_{OUT} = 0A$ ,  $f_{SW} = 2.5MHz$ ,  $C_{OUT} = 2 \times 22\mu F$  CERAMIC CAPACITORS

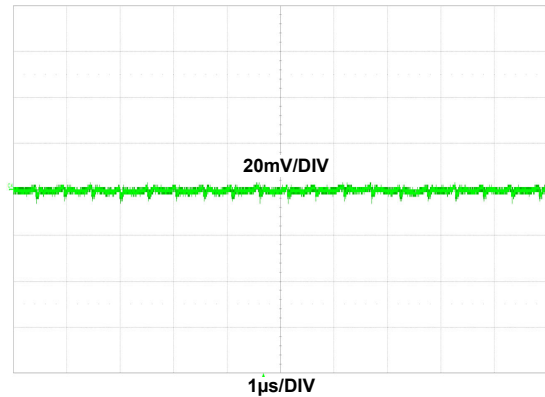

FIGURE 13.  $V_{IN} = 3.3V$ ,  $V_{OUT} = 2.5V$ ,  $I_{OUT} = 5A$ ,  $f_{SW} = 2.5MHz$ ,  $C_{OUT} = 2 \times 22\mu F$  CERAMIC CAPACITORS

### Load Transient Response $T_A = +25^\circ C$ , load current step slew rate: $1A/\mu s$ .

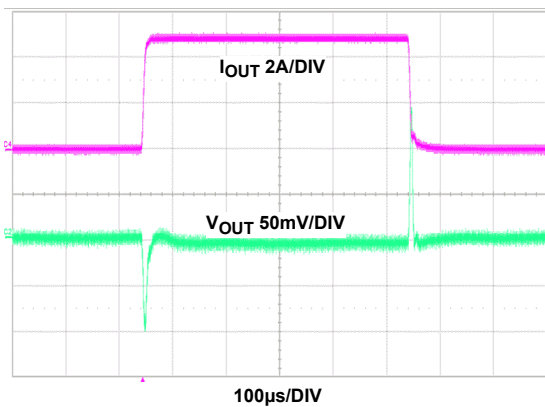

FIGURE 14.  $V_{IN} = 5V$ ,  $V_{OUT} = 1V$ ,  $I_{OUT} = 0$  TO  $5A$ ,  $f_{SW} = 1.3MHz$ ,  $C_{OUT} = 2 \times 22\mu F$  CERAMIC CAPACITORS

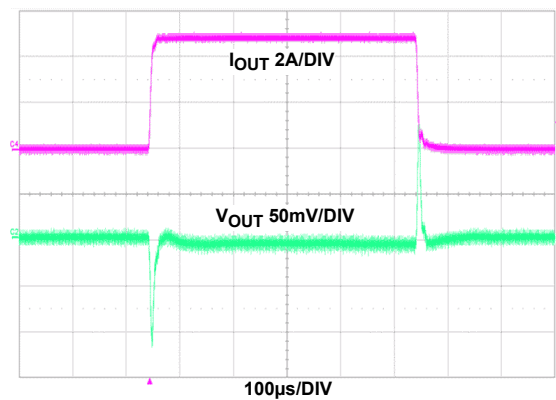

FIGURE 15.  $V_{IN} = 5V$ ,  $V_{OUT} = 1.2V$ ,  $I_{OUT} = 0$  TO  $5A$ ,  $f_{SW} = 1.6MHz$ ,  $C_{OUT} = 2 \times 22\mu F$  CERAMIC CAPACITORS

## Typical Performance Characteristics (Continued)

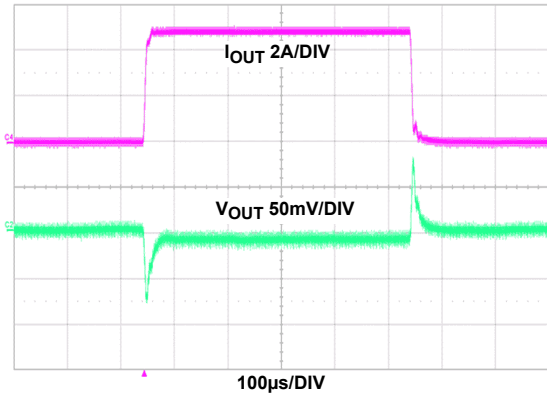

FIGURE 16.  $V_{IN} = 5V$ ,  $V_{OUT} = 2.5V$ ,  $I_{OUT} = 0$  TO  $5A$ ,  $f_{SW} = 2.5MHz$ ,  $C_{OUT} = 2 \times 22\mu F$  CERAMIC CAPACITORS

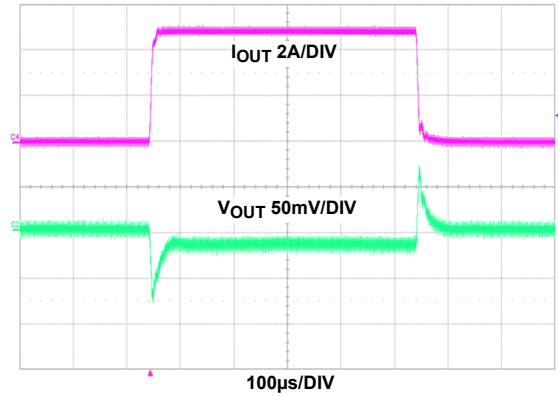

FIGURE 17.  $V_{IN} = 5V$ ,  $V_{OUT} = 3.3V$ ,  $I_{OUT} = 0$  TO  $5A$ ,  $f_{SW} = 3MHz$ ,  $C_{OUT} = 2 \times 22\mu F$  CERAMIC CAPACITORS

### Start-Up $T_A = +25^\circ C$ , Resistor load is used in the test.

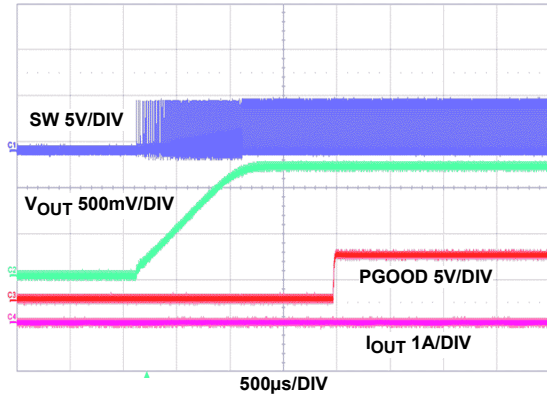

FIGURE 18. SOFT-START WITH 0A LOAD PWM MODE,  $V_{IN} = 5V$ ,  $V_{OUT} = 1.2V$ ,  $I_{OUT} = 0A$ ,  $C_{OUT} = 2 \times 22\mu F$  CERAMIC CAPACITORS,  $C_{IN} = 100\mu F$  POSCAP +  $2 \times 22\mu F$  CERAMIC CAPACITORS

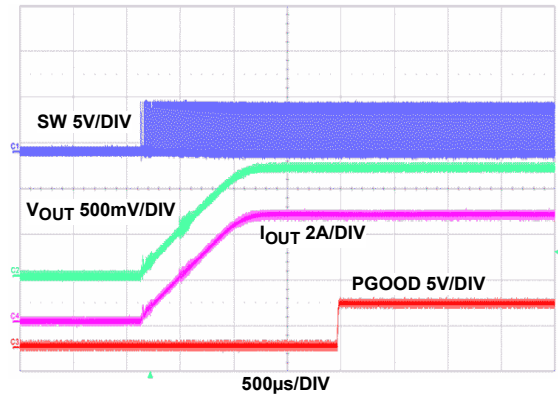

FIGURE 19. SOFT-START WITH 5A LOAD PWM MODE,  $V_{IN} = 5V$ ,  $V_{OUT} = 1.2V$ ,  $I_{OUT} = 5A$ ,  $C_{OUT} = 2 \times 22\mu F$  CERAMIC CAPACITORS,  $C_{IN} = 100\mu F$  POSCAP +  $2 \times 22\mu F$  CERAMIC CAPACITORS

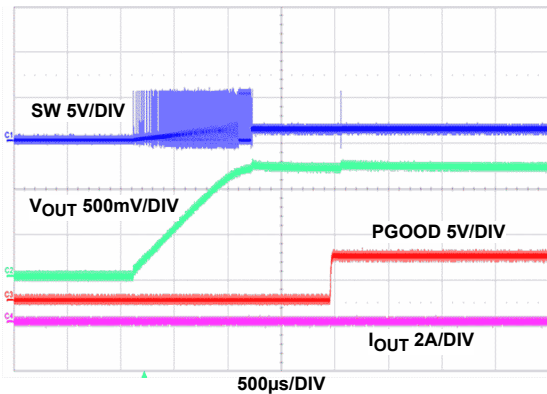

FIGURE 20. SOFT-START WITH 0A LOAD PFM MODE,  $V_{IN} = 5V$ ,  $V_{OUT} = 1.2V$ ,  $I_{OUT} = 0A$ ,  $C_{OUT} = 2 \times 22\mu F$  CERAMIC CAPACITORS,  $C_{IN} = 100\mu F$  POSCAP +  $2 \times 22\mu F$  CERAMIC CAPACITORS

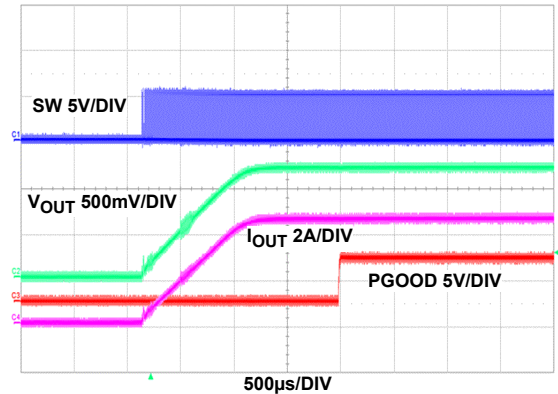

FIGURE 21. SOFT-START WITH 5A LOAD PFM MODE,  $V_{IN} = 5V$ ,  $V_{OUT} = 1.2V$ ,  $I_{OUT} = 5A$ ,  $C_{OUT} = 2 \times 22\mu F$  CERAMIC CAPACITORS,  $C_{IN} = 100\mu F$  POSCAP +  $2 \times 22\mu F$  CERAMIC CAPACITORS

## Typical Performance Characteristics (Continued)

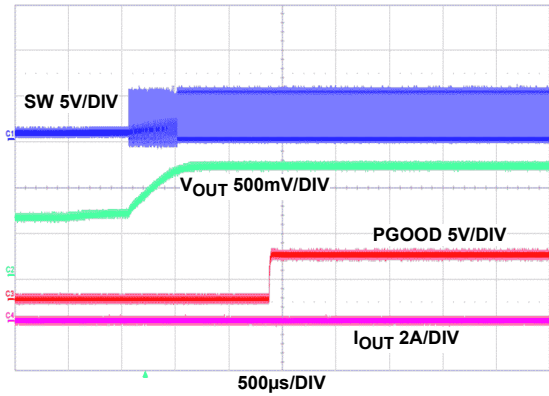

FIGURE 22. PREBIAS SOFT-START WITH 0A LOAD PWM MODE,  $V_{IN} = 5V$ ,  $V_{OUT} = 1.2V$ ,  $I_{OUT} = 0A$ ,  $C_{OUT} = 2 \times 22\mu F$  CERAMIC CAPACITORS,  $C_{IN} = 100\mu F$  POSCAP +  $2 \times 22\mu F$  CERAMIC CAPACITORS

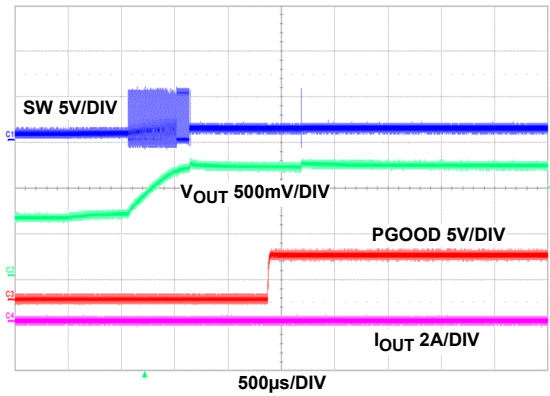

FIGURE 23. PREBIAS SOFT-START WITH 0A LOAD PFM MODE,  $V_{IN} = 5V$ ,  $V_{OUT} = 1.2V$ ,  $I_{OUT} = 0A$ ,  $C_{OUT} = 2 \times 22\mu F$  CERAMIC CAPACITORS,  $C_{IN} = 100\mu F$  POSCAP +  $2 \times 22\mu F$  CERAMIC CAPACITORS

**Short-Circuit Protection**  $T_A = +25^\circ C$ ,  $V_{IN} = 5V$ ,  $V_{OUT} = 1.2V$ ,  $C_{IN} = 100\mu F$  POScap +  $22\mu F$  ceramic capacitors,  $C_{OUT} = 2 \times 22\mu F$  ceramic capacitors, output short-circuit during normal operation.

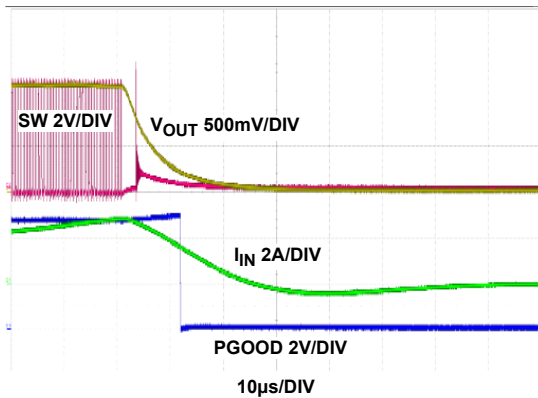

FIGURE 24. OUTPUT SHORT-CIRCUIT PROTECTION

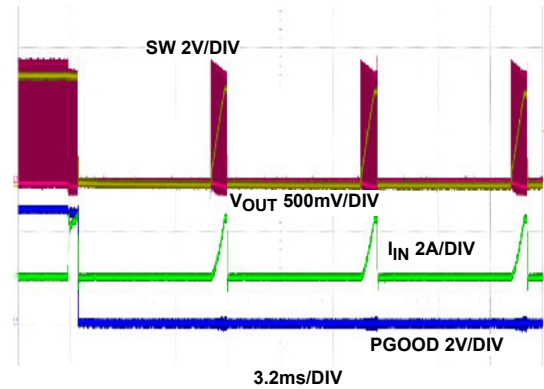

FIGURE 25. OUTPUT SHORT-CIRCUIT PROTECTION, HICCUP MODE

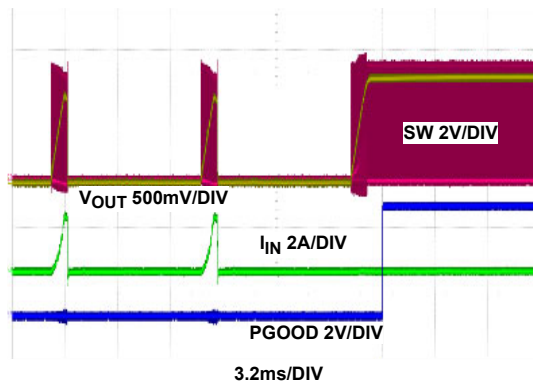

FIGURE 26. OUTPUT SHORT-CIRCUIT RECOVER FROM HICCUP

## Typical Performance Characteristics (Continued)

**Overvoltage Protection**  $T_A = +25^\circ\text{C}$ ,  $V_{IN} = 5\text{V}$ ,  $V_{OUT} = 1.2\text{V}$ ,  $C_{IN} = 100\mu\text{F}$  POScap +  $22\mu\text{F}$  ceramic capacitors,  $C_{OUT} = 2 \times 22\mu\text{F}$  ceramic capacitors.

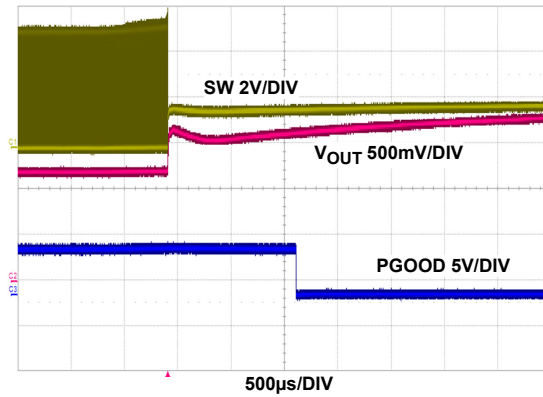

FIGURE 27. OUTPUT OVERVOLTAGE PROTECTION

**Power Loss**  $T_A = +25^\circ\text{C}$ ,  $C_{IN} = 100\mu\text{F}$  POScap +  $22\mu\text{F}$  ceramic capacitors,  $C_{OUT} = 2 \times 22\mu\text{F}$  ceramic capacitors.

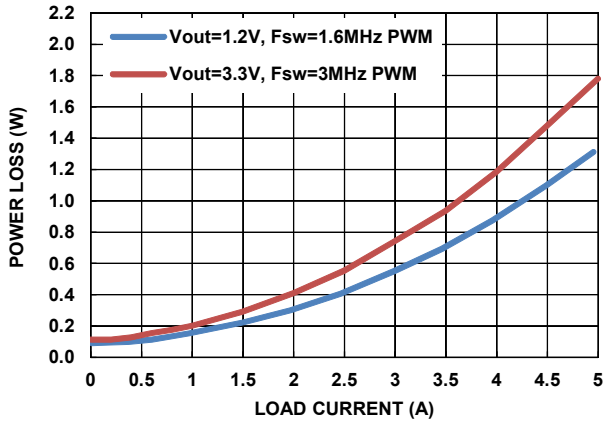

FIGURE 28. POWER LOSS AT  $V_{IN} = 5\text{V}$ ,  $T_A = +25^\circ\text{C}$

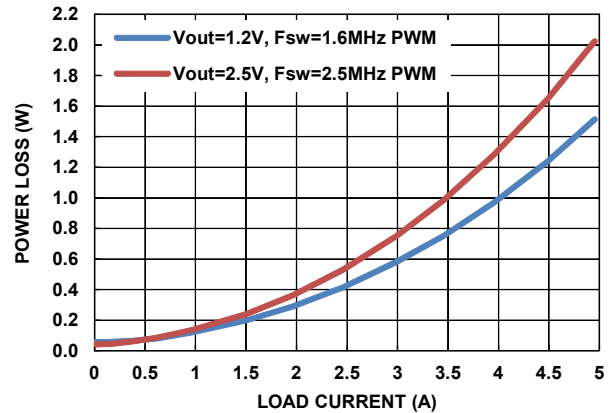

FIGURE 29. POWER LOSS AT  $V_{IN} = 3.3\text{V}$ ,  $T_A = +25^\circ\text{C}$

**Derating** All of the following curves were plotted at  $T_J = +120^\circ\text{C}$ .

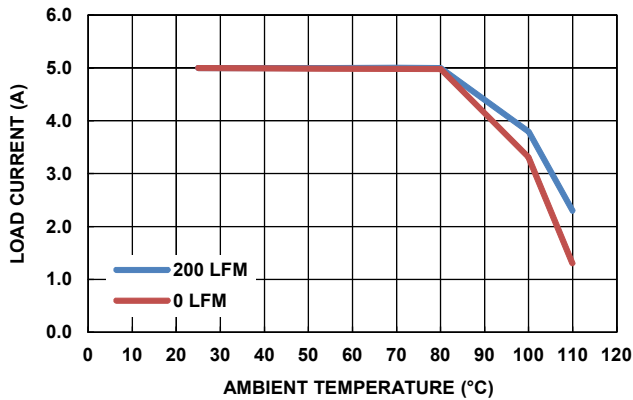

FIGURE 30. DERATING CURVES AT  $V_{IN} = 5\text{V}$ ,  $V_{OUT} = 1.2\text{V}$

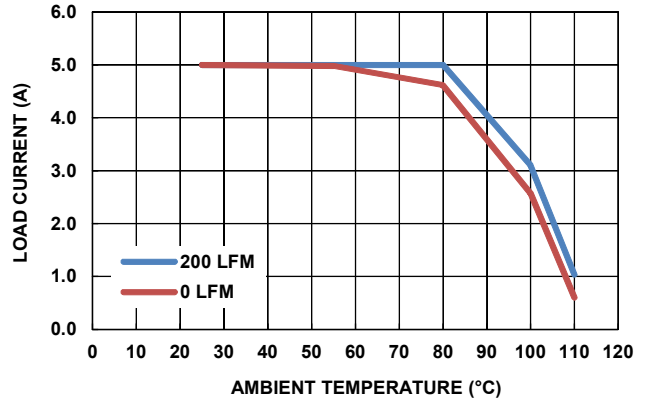

FIGURE 31. DERATING CURVES AT  $V_{IN} = 5\text{V}$ ,  $V_{OUT} = 3.3\text{V}$

## Typical Performance Characteristics (Continued)

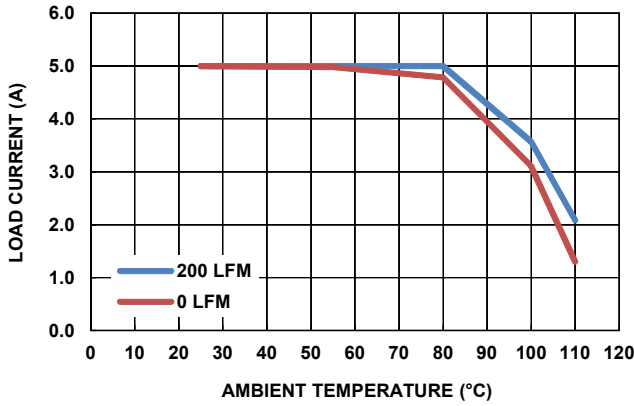

FIGURE 32. DERATING CURVES AT  $V_{IN} = 3.3V$ ,  $V_{OUT} = 1.2V$

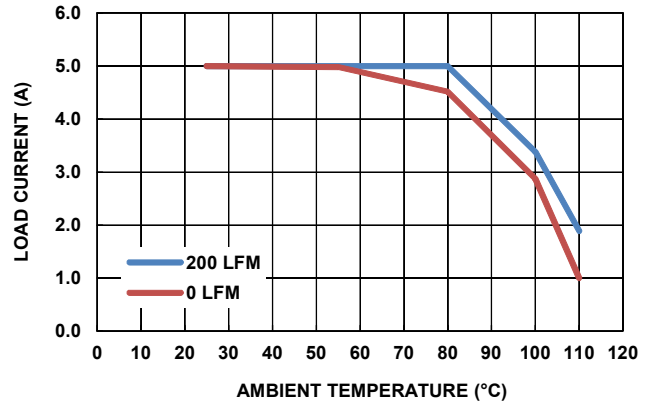

FIGURE 33. DERATING CURVES AT  $V_{IN} = 3.3V$ ,  $V_{OUT} = 2.5V$

TABLE 2. ISL8205M DESIGN GUIDE MATRIX (REFER TO [Figure 1](#))

$V_{IN}$ (V)	$V_{OUT}$ (V)	$f_{SW}$ (MHz)	$C_{IN}$ ( $\mu F$ )	$C_{OUT}$ ( $\mu F$ )	$R_{FS}$ (k $\Omega$ )	$R_{SET}$ (k $\Omega$ )	$C_{FF}$ (pF)
5	0.6	0.8	2x22	1x100	261	OPEN	390
5	0.9	1.2	2x22	3x22	169	200	560
5	1	1.3	2x22	3x22	154	150	560
5	1.2	1.6	2x22	2x22	124	100	820
5	1.5	1.7	2x22	2x22	115	66.5	560
5	1.8	2	2x22	2x22	95.3	49.9	470
5	2.5	2.5	2x22	2x22	75	31.6	330
5	3.3	3	2x22	2x22	59	22.1	330
3.3	0.6	0.8	2x22	1x100	261	OPEN	390
3.3	0.9	1.2	2x22	3x22	169	200	560
3.3	1	1.3	2x22	3x22	154	150	560
3.3	1.2	1.6	2x22	2x22	124	100	820
3.3	1.5	1.7	2x22	2x22	115	66.5	560
3.3	1.8	2	2x22	2x22	95.3	49.9	470
3.3	2.5	2.5	2x22	2x22	75	31.6	330

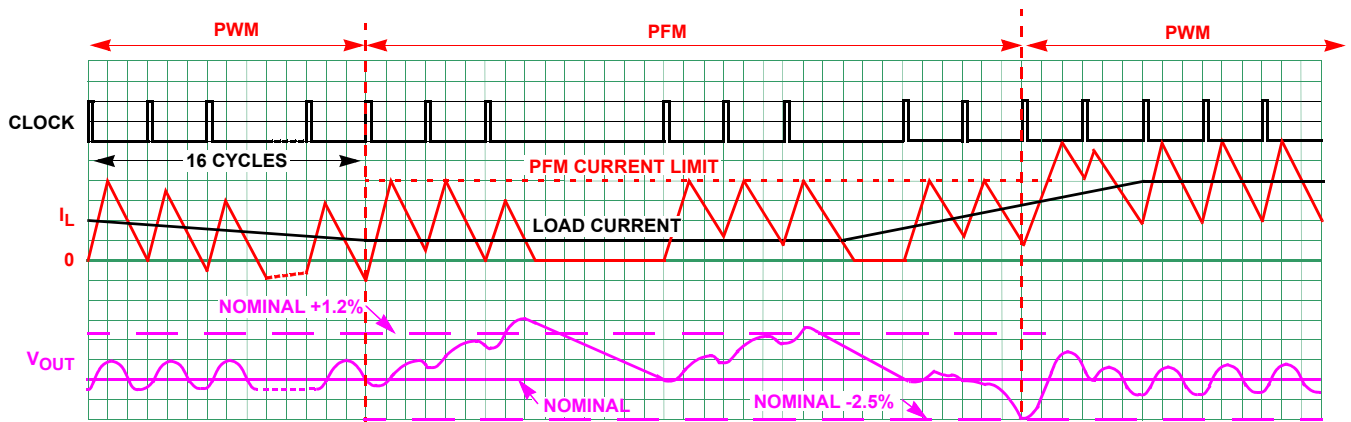

FIGURE 34. PFM MODE OPERATION WAVEFORMS

## Functional Description

The ISL8205M is a single channel 5A step-down high efficiency power module optimized for FPGA, DSP and Li-ion battery power devices. The module switches at 1.8MHz by default when the FS pin is shorted to VIN. The switching frequency is also adjustable from 680kHz to 3.5MHz through a resistor,  $R_{FS}$ , from FS to SGND. To boost light-load efficiency, ISL8205M can also be configured to operate in PFM mode by pulling the SYNC pin to SGND. Peak current mode control scheme is implemented for fast transient response. By shorting the COMP pin to VIN, the module utilizes internal compensation to stabilize system and optimize transient response. Other excellent features include external synchronization, 100% duty cycle operation and very low quiescent current.

### PWM Control Scheme

Pulling the SYNC pin high (>0.8V) forces the module into PWM mode, regardless of output current. The ISL8205M employs the current-mode Pulse-Width Modulation (PWM) control scheme for fast transient response and pulse-by-pulse current limiting. As shown in [Figure 3 on page 3](#), the current loop consists of the oscillator, the PWM comparator, current sensing circuit and the slope compensation for the current loop stability. The slope compensation is 440mV/Ts, which changes with frequency. The gain for the current sensing circuit is typically 140mV/A. The control reference for the current loops comes from the Error Amplifier's (EAMP) output.

The PWM operation is initialized by the clock from the oscillator. The P-channel MOSFET is turned on at the beginning of a PWM cycle and the current in the MOSFET starts to ramp up. When the sum of the current amplifier, CSA and the slope compensation reaches the control reference of the current loop, the PWM comparator COMP sends a signal to the PWM logic to turn off the PFET and turn on the N-channel MOSFET. The NFET stays on until the end of the PWM cycle. [Figure 35](#) shows the typical operating waveforms during the PWM operation. The dotted lines illustrate the sum of the slope compensation ramp and the Current-Sense Amplifier's (CSA) output.

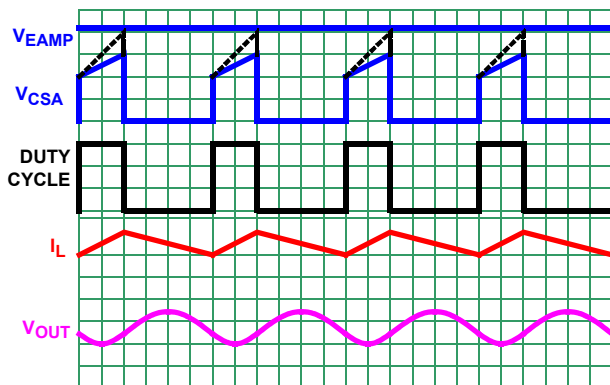

FIGURE 35. PWM OPERATION WAVEFORMS

The output voltage is regulated by controlling the  $V_{EAMP}$  voltage to the current loop. The bandgap circuit outputs a 0.6V reference voltage to the voltage loop. The feedback signal comes from the VFB pin. The soft-start block only affects the operation during

start-up and will be discussed separately, please refer to [“Soft Start-Up” on page 16](#). The error amplifier is a transconductance amplifier that converts the voltage error signal to a current output. When the COMP is tied to VIN, the voltage loop is internally compensated with the 55pF and 100kΩ RC network.

### PFM (Skip) Mode

Pulling the SYNC pin LOW (<0.4V) forces the module into PFM mode. The ISL8205M enters a pulse-skipping mode at light load to minimize the switching losses by reducing the switching frequency. [Figure 34](#) illustrates the Skip mode operation. A zero-cross sensing circuit shown in [Figure 3 on page 3](#) monitors the NFET current for zero crossing. When 16 consecutive cycles are detected, the module enters the Skip mode. During the sixteen detecting cycles, the current in the inductor is allowed to become negative. The counter is reset to zero when the current in any cycle does not cross zero.

Once the Skip mode is entered, the pulse modulation starts being controlled by the skip comparator shown in [Figure 3 on page 3](#). Each pulse cycle is still synchronized by the PWM clock. The PFET is turned on at the clock's rising edge and turned off when the output is higher than 1.2% of the nominal regulation or when its current reaches the peak skip current limit value. Then, the inductor current is discharged to 0A and stays at zero (the internal clock is disabled) and the output voltage reduces gradually due to the load current discharging the output capacitor. When the output voltage drops to the nominal voltage, the PFET will be turned on again at the rising edge of the internal clock as it repeats the previous operations. The module resumes normal PWM mode operation when the output voltage drops 2.5% below the nominal voltage.

### Frequency Adjust

The switching frequency of ISL8205M is adjustable ranging from 680kHz to 3.5MHz via a simple resistor  $R_{FS}$  across FS to SGND. The switching frequency setting is based on [Equation 1](#):

$$R_{FS}[\text{k}\Omega] = \frac{220 \cdot 10^3}{f_{OSC}[\text{kHz}]} - 14 \quad (\text{EQ. 1})$$

When the FS pin is directly tied to VIN, the frequency of operation is fixed at 1.8MHz. For selections of switching frequency of typical operation conditions, refer to [Table 2 on page 14](#). More detailed information on recommended switching frequency is provided in [“Recommended Switching Frequency” on page 17](#).

### Overcurrent Protection

The overcurrent protection is realized by monitoring the CSA output with the OCP comparator, as shown in [Figure 3 on page 3](#). The current sensing circuit has a gain of 140mV/A, from the PFET current to the CSA output. When the CSA output reaches the threshold, the OCP comparator is tripped and turns off the PFET immediately. The overcurrent function protects the module from a shorted output by monitoring the current flowing through the upper MOSFET.

Upon detection of an overcurrent condition, the upper MOSFET will be immediately turned off and will not be turned on again until the next switching cycle. Upon detection of the initial overcurrent condition, the overcurrent fault counter is set to 1. If,

on the subsequent cycle, another overcurrent condition is detected, the OC fault counter will be incremented. If there are 17 sequential OC fault detections, the module will be shut down under an overcurrent fault condition. An overcurrent fault condition will result in the module attempting to restart in a Hiccup mode within the delay of eight soft-start periods. At the end of the 8<sup>th</sup> soft-start wait period, the fault counters are reset and soft-start is attempted again. If the overcurrent condition goes away during the delay of 8 soft-start periods, the output will resume back into regulation after the Hiccup mode expires.

## Negative Current Protection

Similar to overcurrent, the negative current protection is realized by monitoring the current across the low-side NFET, as shown in [Figure 3 on page 3](#). When the valley point of the inductor current reaches -3A for 4 consecutive cycles, both PFET and NFET are turned off. The 100Ω in parallel to the NFET will activate discharging the output into regulation. The control will begin to switch when output is within regulation. The module will be in PFM for 20μs before switching to PWM, if necessary.

## Power-Good

PG is an open-drain output of a window comparator that continuously monitors the module output voltage. PG is actively held low when EN is low and during the module soft-start period. After 1ms delay of the soft-start period, PG becomes high impedance as long as the output voltage is within the nominal regulation voltage set by V<sub>FB</sub>. Under output overvoltage fault condition (output voltage is 33% higher than nominal value) or output undervoltage fault condition (output voltage is 15% lower than nominal value), the PG will be pulled low. Any fault condition forces PG low until the fault condition is cleared by attempts to soft-start. For logic level output voltages, connect an external pull-up resistor between PG and VIN. A 100kΩ resistor works well in most applications.

## UVLO

When the input voltage is below the Undervoltage Lockout (UVLO) threshold, the module is disabled.

## Soft Start-Up

The soft start-up reduces the inrush current during the start-up. The soft-start block outputs a ramp reference to the input of the error amplifier. This voltage ramp limits the inductor current as well as the output voltage speed, so that the output voltage rises in a controlled fashion. When V<sub>FB</sub> is less than 0.1V at the beginning of the soft-start, the switching frequency is reduced to 200kHz, so that the output can start-up smoothly at light load condition. During soft-start, the IC operates in the Skip mode to support prebiased output condition.

Tie SS to SGND for internal soft-start, which is approximately 1ms. Connect a capacitor from SS to SGND to adjust the soft-start time. This capacitor, along with an internal 1.85μA current source sets the soft-start interval of the module, t<sub>SS</sub>, as shown by [Equation 2](#).

$$C_{SS}[\mu\text{F}] = 3.1 \cdot t_{SS}[\text{s}] \quad (\text{EQ. 2})$$

C<sub>SS</sub> must be less than 33nF to insure proper soft-start reset after fault condition.

## External Synchronization Control

The frequency of operation can be synchronized up to 3.5MHz by an external signal applied to the SYNC pin. The rising edge of SYNC signal triggers the rising edge of PWM ON pulse. To ensure proper operation, it is recommended that the external SYNC frequency is within ±25% of the switching frequency set by FS pin.

## Enable

The enable (EN) input allows the user to control the turning on or off of the module for purposes such as power-up sequencing. When the module is enabled, there is typically a 600μs delay for waking up the bandgap reference and then the soft start-up begins.

## Discharge Mode (Soft-Stop)

When a transition to Shutdown mode occurs or the VIN UVLO is set, the output discharges to PGND through an internal 100Ω switch.

## 100% Duty Cycle

The ISL8205M features a 100% duty cycle operation to minimize switching loss. When the input voltage drops to a level that the ISL8205M can no longer maintain the regulation at the output, the module completely turns on the PFET.

## Thermal Shutdown

The ISL8205M has built-in thermal protection. When the internal temperature reaches +150°C, the module is completely shut down. As the temperature drops to +125°C, the ISL8205M, resumes operation by stepping through the soft-start.

## Applications Information

### Programming the Output Voltage

The output voltage of the module is programmed by an external resistor, as R<sub>SET</sub> in [Figure 1 on page 1](#) applied from FB pin to SGND. R<sub>SET</sub> in combination with the internal 100kΩ 0.5% resistor connected from FB to VSENSE forms a resistor divider that sets the output voltage. The output voltage is governed by [Equation 3](#).

$$V_{\text{OUT}} = V_{\text{REF}} \cdot \frac{R_{\text{SET}} + 100\text{k}\Omega}{R_{\text{SET}}} \quad (\text{EQ. 3})$$

TABLE 3. TYPICAL VOLTAGE SETTING RESISTOR VALUES

V <sub>OUT</sub> (V)	R <sub>SET</sub> (kΩ)
0.6	OPEN
0.8	300
1.0	150
1.2	100
1.8	49.9
2.5	31.6
3.3	22.1

Please note that the output voltage accuracy is also dependent on the resistor accuracy of R<sub>FS</sub>. The user needs to select high accuracy resistors in order to achieve the overall output accuracy.

### Recommended Switching Frequency

With varieties of input and output voltage combinations, one must choose wisely on which frequency to operate at. Selection of switching frequency for each V<sub>IN</sub> and V<sub>OUT</sub> combination needs to take into account a few trade-offs. Generally, lower switching frequency will lead to higher efficiency. However, switching frequency should not be decreased too low due to negative current protection limit. Moreover, when output voltage is relatively high, low switching frequency will result in more sub-harmonic oscillation. Therefore, operating frequency needs to be kept relatively high under high V<sub>OUT</sub> conditions. However, again, switching frequency cannot be increased too much. Otherwise, the minimum on-time limit could be violated. Based on these considerations, [Figure 36](#) provides the recommended switching frequency under various typical V<sub>IN</sub> and across V<sub>OUT</sub> range.

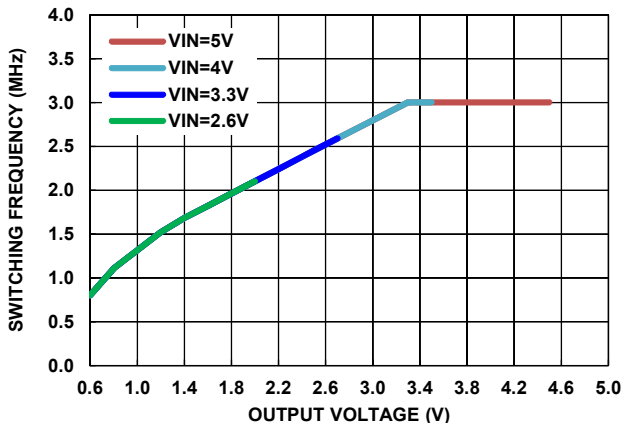

FIGURE 36. SWITCHING FREQUENCY RECOMMENDATION

### Input Capacitor Selection

Selection of the input filter capacitor is based on how much ripple the supply can tolerate on the DC input line. The larger the capacitor, the less ripple expected, however, consideration should be given to the higher surge current during power-up. The ISL8205M provides a soft-start function that controls and limits the current surge. The total capacitance of the input capacitor can be calculated based on [Equation 4](#):

$$C_{IN(MIN)} = \frac{I_O \cdot D(1-D)}{V_{P-P} \cdot f_{SW}} \quad (\text{EQ. 4})$$

Where:

- C<sub>IN(MIN)</sub> is the minimum required input capacitance (μF)
- I<sub>O</sub> is the output current (A)
- D is the duty cycle
- V<sub>P-P</sub> is the allowable peak-to-peak voltage (V)
- f<sub>SW</sub> is the switching frequency (Hz)

Low Equivalent Series Resistance (ESR) ceramic capacitance is recommended to be placed as close as possible to the module input to reduce input voltage ripple and decouple between the VIN and PGND. This capacitance not only reduces voltage ringing created by the switching current across parasitic circuit elements, but also reduces the input noise seen by the module. Moreover, the estimated RMS ripple current should be considered in choosing ceramic capacitors. The RMS ripple current can be calculated by [Equation 5](#)

$$I_{IN(RMS)} = \frac{I_O \cdot \sqrt{D(1-D)}}{\eta} \quad (\text{EQ. 5})$$

Each 22μF X5R or X7R ceramic capacitor is typically good for 2A to 3A of RMS ripple current. Refer to the capacitor vendor to check the RMS current ratings.

Based on the above considerations, minimum total input capacitance of 44μF is required for ISL8205M. Add additional capacitance if possible. Use X5R or X7R ceramic capacitors. The placement of the input ceramic capacitors should be as close as possible to the module input. Refer to [“PCB Layout Pattern Design” on page 20](#) for more information. A bulk input capacitance may also be needed if the input source does not have enough output capacitance. A typical value of bulk input capacitor is 100μF. In such conditions, this bulk input capacitance can supply the current during output load transient conditions.

### Output Capacitor Selection

Ceramic capacitors are typically used as the output capacitors for the ISL8205M. Refer to [Table 2 on page 14](#) for recommended output capacitor values. Bulk output capacitors that have adequately low Equivalent Series Resistance (ESR), such as low ESR polymer capacitors or a low ESR tantalum capacitor, may also be used in combination with the ceramic capacitors, depending on the output voltage ripple and transient requirements.

### Feed-Forward Capacitor Selection

In typical applications where the output capacitors are all ceramic, a feed-forward capacitor, as shown as C<sub>FF</sub> in [Figure 1 on page 1](#), is needed to insure loop stability in extreme operating conditions. With internal compensation mode enabled, the C<sub>FF</sub> values for typical operating conditions are optimized and listed in [Table 2 on page 14](#). Please note that, for system parameters that are different from [Table 2](#) or external instead of internal compensation is used, the optimized value of C<sub>FF</sub> needs to be adjusted.

### Typical Application Circuit

Figure 1 on page 1 only illustrates the application circuit with minimum external components required for operation in PWM mode. A more comprehensive typical application circuit diagram is shown in Figure 37. In this example, a pull-up resistor is added to the PG pin to allow power-good signal monitoring. Soft start-up time adjustment is achieved by adding a capacitor,  $C_{SS}$ , to the SS pin. Typical application circuit of PFM mode operation can also be found in Figure 38.

### Thermal Consideration and Current Derating

The ISL8205M's thermally enhanced package offers typical junction to ambient thermal resistance  $\theta_{JA}$  of approximately 27.4 °C/W at natural convection with a typical 4-layer PCB board. In applications with elevated ambient temperature, the continuous current handling capability of the module may need

to be derated. The derating curves (Figure 30 through 33) are fully tested. They are on the basis of determining the maximum junction temperature to +120 °C, which provides 5 °C margin of safety from the rated junction temperature of +125 °C. The test was done across various typical operating conditions, providing a starting point for system thermal design. Note that all the derating curves are obtained based on tests in free air with the module mounted on the ISL8205MEVAL1Z evaluation board with "direct attach" features. Refer to ISL8205MEVAL1Z User Guide for evaluation board details. Also see Tech Brief TB379 for general thermal metric information.

In real applications where the system parameters and layout are different than the evaluation board, the customer can adjust the margin of safety. Other heat sources and design margins also need to be taken into consideration.

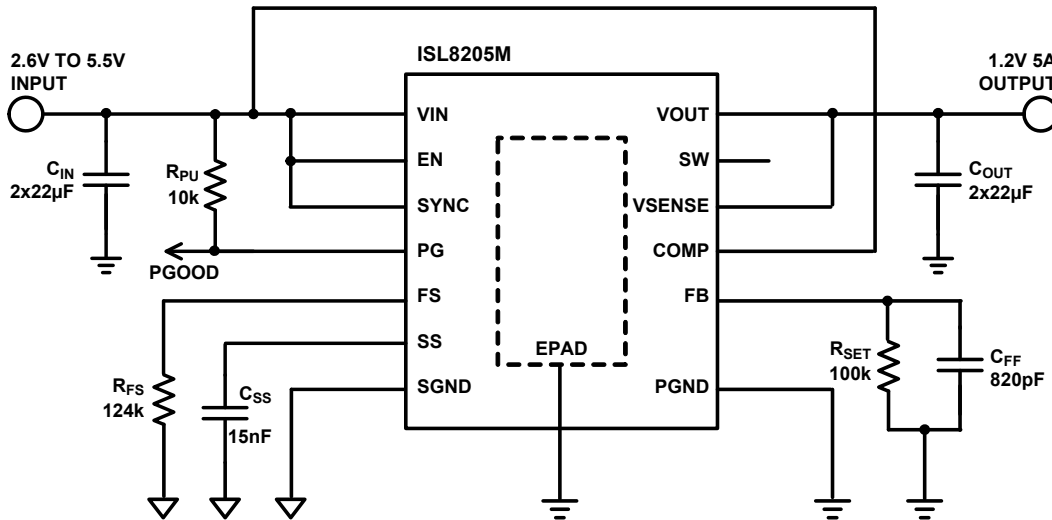

FIGURE 37. COMPLETE APPLICATION CIRCUIT DIAGRAM

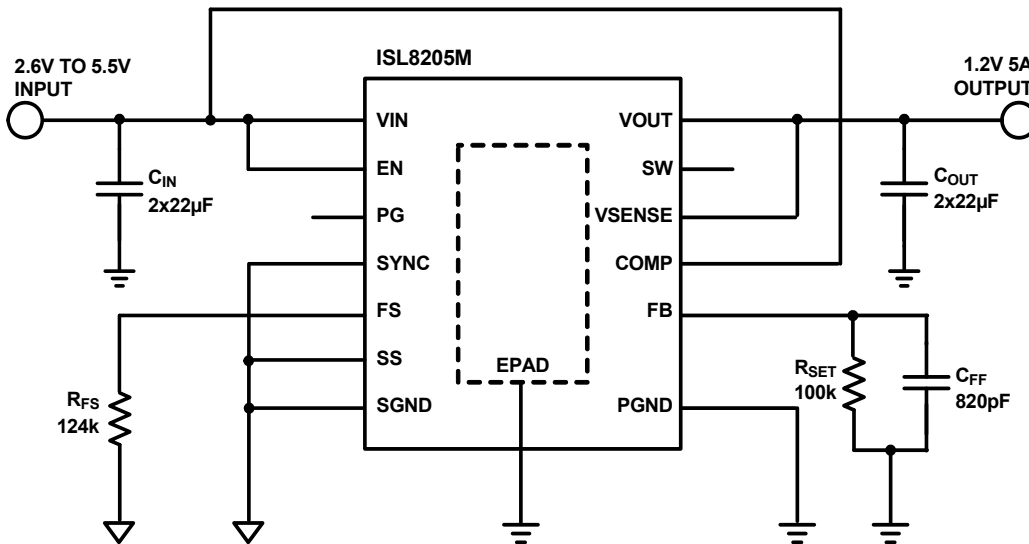

FIGURE 38. TYPICAL APPLICATION CIRCUIT DIAGRAM IN PFM MODE

## PCB Layout Recommendations

A few layout considerations need to be taken into account in order to achieve proper operation of ISL8205M. An optimized layout design also allows the module to have lower power loss and good thermal performance. An illustrative layout example is shown in [Figures 39](#) and [40](#). Key points are listed in the following:

- Place the input ceramic capacitors as close as possible to the module input. These ceramic capacitors are used to minimize the high frequency noise by reducing parasitic inductance of the switching loop. Optimized placement of these capacitors will not only lead to less switch node ringing, but also minimize the noise seen by the module to insure proper operation. It is recommended to use X5R or X7R ceramic capacitors with a minimum total capacitance of 44 $\mu$ F at module input. It is a **MUST** that one of the input capacitors ( $C_{IN1}$ ), with no less than 3.3 $\mu$ F capacitance, should be placed on the same layer (assuming top layer) as the module and within less than 70 mil clearance to module input (refer to [Figure 39](#)). For capacitors on the bottom layer, it is recommended to have one ( $C_{IN2}$ ) placed from VIN to PGND copper close to exposed pad (Pad 20) vias (as shown in the layout example in [Figure 40](#)).
- Use large copper areas for power path (VIN, PGND) to minimize conduction loss and thermal stress. Also, it is recommended to use multiple vias to connect the power planes in different layers. Use at least 5 vias on the exposed Pad 20 connected to PGND plane(s) for the best thermal relief.
- Use a separate SGND ground copper area for components that are connected to signal ground. Connect SGND copper to module Pad 22 through multiple vias (refer to [Figure 40](#)). Because Pad 22 is connected to module internal PGND at single location, the SGND copper area and PGND plane on the PCB can be left separated.
- It is recommended to keep the SW pads only on the top and inner layers of the PCB. Do not expose the SW pads to the outside on the bottom layer of the PCB. In order to minimize switch node resistance, connect Pads 21 and 9 using wide trace or shape.
- If remote sense is needed, route remote sensing trace from point-of-load to module VSENSE pin through quiet inner layer that is shielded by PGND planes.
- Avoid routing noise-sensitive signal traces such as FB, COMP near the noisy SW pins.
- The feedback and compensation network should be placed as close as possible to the FB pins and far away from the SW pins.

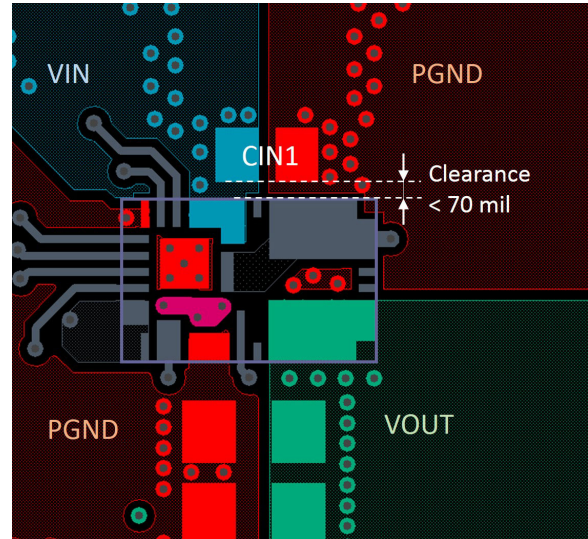

FIGURE 39. LAYOUT EXAMPLE - TOP LAYER

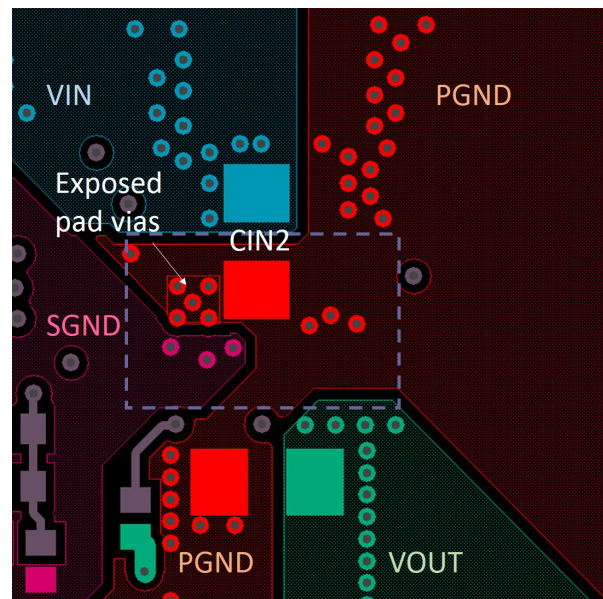

FIGURE 40. LAYOUT EXAMPLE - BOTTOM LAYER

## Package Description

The ISL8205M is integrated into a Quad Flatpack No-Lead (QFN) package. This package has such advantages as good thermal and electrical conductivity, low weight and small size. The QFN package is applicable for surface mounting technology and is becoming more common in the industry. The ISL8205M is a copper leadframe based package with exposed copper thermal pads, which have good electrical and thermal conductivity. The copper leadframe and multicomponent assembly are overmolded with polymer mold compound to protect these devices.

The package outline, typical PCB layout pattern and typical stencil pattern design are shown in the L22.4.5x7.5 [“Package Outline Drawing” on page 22](#). [TB493](#) shows typical reflow profile parameters. These guidelines are general design rules. Users can modify parameters according to specific applications.

## PCB Layout Pattern Design

The bottom of ISL8205M is a leadframe footprint, which is attached to the PCB by surface mounting. The PCB layout pattern is shown in the L22.4.5x7.5 [“Package Outline Drawing” on page 22](#). The PCB layout pattern is essentially 1:1 with the QFN exposed pad and the I/O termination dimensions, except that the PCB lands are slightly longer than the QFN terminations by about 0.2mm (0.4mm maximum). This extension allows for solder filleting around the package periphery and ensures a more complete and inspectable solder joint. The thermal lands on the PCB layout should match 1:1 with the package exposed die pads.

## Thermal Vias

A grid of 1.0mm to 1.2mm pitched thermal vias, which drops down and connects to buried copper planes, should be placed under the thermal land. The vias should be about 0.3mm to 0.33mm in diameter, with the barrel plated to about 2.0 ounce copper. Although adding more vias (by decreasing pitch) improves thermal performance, it also diminishes results as more vias are added. Use only as many vias as needed for the thermal land size and as your board design rules allow.

## Stencil Pattern Design

Reflowed solder joints on the perimeter I/O lands should have about a 50µm to 75µm (2 mil to 3 mil) standoff height. The solder paste stencil design is the first step in developing optimized, reliable solder joints. The stencil aperture size to land size ratio should typically be 1:1. Aperture width may be reduced slightly to help prevent solder bridging between adjacent I/O lands.

To reduce solder paste volume on the larger thermal lands, an array of smaller apertures instead of one large aperture is recommended. The stencil printing area should cover 50% to 80% of the PCB layout pattern. Consider the symmetry of the whole stencil pattern when designing the pads.

A laser-cut, stainless-steel stencil with electropolished trapezoidal walls is recommended. Electropolishing smooths the aperture walls, resulting in reduced surface friction and better paste release, which reduces voids. Using a Trapezoidal Section Aperture (TSA) also promotes paste release and forms a brick-like paste deposit, which assists in firm component placement.

## Reflow Parameters

Due to the low mount height of the QFN, “No Clean” Type 3 solder paste, per ANSI/J-STD-005, is recommended. Nitrogen purge is also recommended during reflow. A system board reflow profile depends on the thermal mass of the entire populated board, thus, it is not practical to define a specific soldering profile just for the QFN. The profile given in [TB493](#) is provided as a guideline to customize for varying manufacturing practices and applications.

## Revision History

The revision history provided is for informational purposes only and is believed to be accurate, however, not warranted. Please go to the web to make sure that you have the latest revision.

DATE	REVISION	CHANGE
Jan 25, 2024	4.02	Updated Note 2 in the ordering information table.
Jun 24, 2022	4.01	Removed Related Literature section. Removed About Intersil section. Updated links throughout the document. Updated Ordering information table to the latest format. Added Note 6 to Abs Max section.
Oct 25, 2016	4.00	Updated Ordering Information table tape and reel units for ISL8205MIRZ-T from 4k to 3k.
Aug 15, 2016	3.00	Updated Note 2 on page 5. Updated Figure 36 on page 17, corrected typo on legend.
May 19, 2016	2.00	Related Literature on page 1: Added UG072 link.
May 10, 2016	1.00	Updated title on page 1 Updated default setting from 1.9MHz to 1.8MHz throughout datasheet. Replaced Figure 1 on page 1. Updated Figure 3 on page 3. Updated typical specification for "Nominal Switching Frequency" on page 7 from 1900 to 1835. Added Note 9 on page 8. Added "Typical Application Circuit" section on page 18. On page 25, replaced Recommended Stencil Perimeter Pads view to match POD.
Mar 21, 2016	0.00	Initial release.

# Package Outline Drawing

For the most recent package outline drawing, see [L22.4.5x7.5](#).

L22.4.5x7.5  
22 Lead Quad Flat No-lead Plastic Package  
Rev 0, 9/15

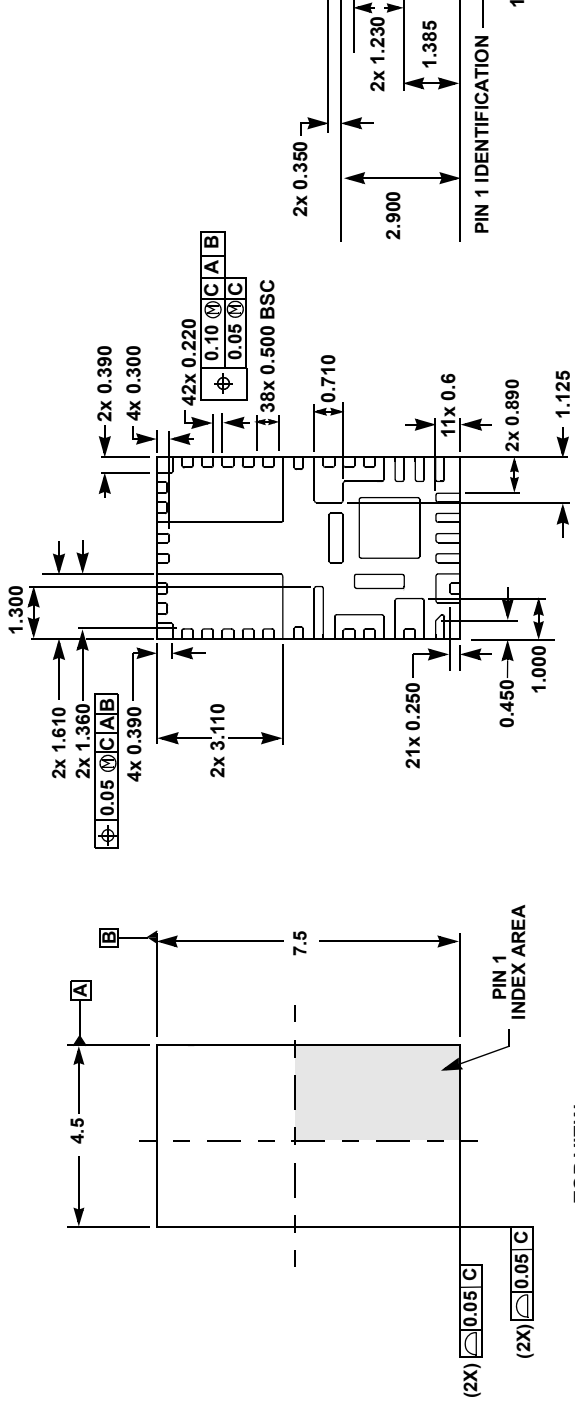

**TOP VIEW**

**BOTTOM VIEW**

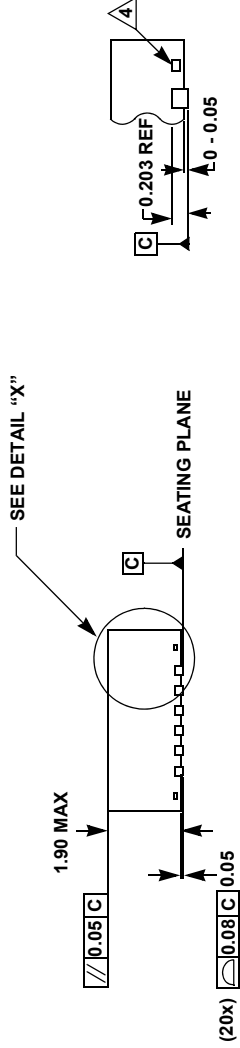

**SIDE VIEW**

**DETAIL "X"**

**NOTES:**

1. Dimensions are in millimeters.
2. Dimensioning and tolerancing
3. Unless otherwise specified, to
4. Tiebar shown (if present) is a n
5. The configuration of the pin #1 located within the zone indicated either a mold or mark feature.

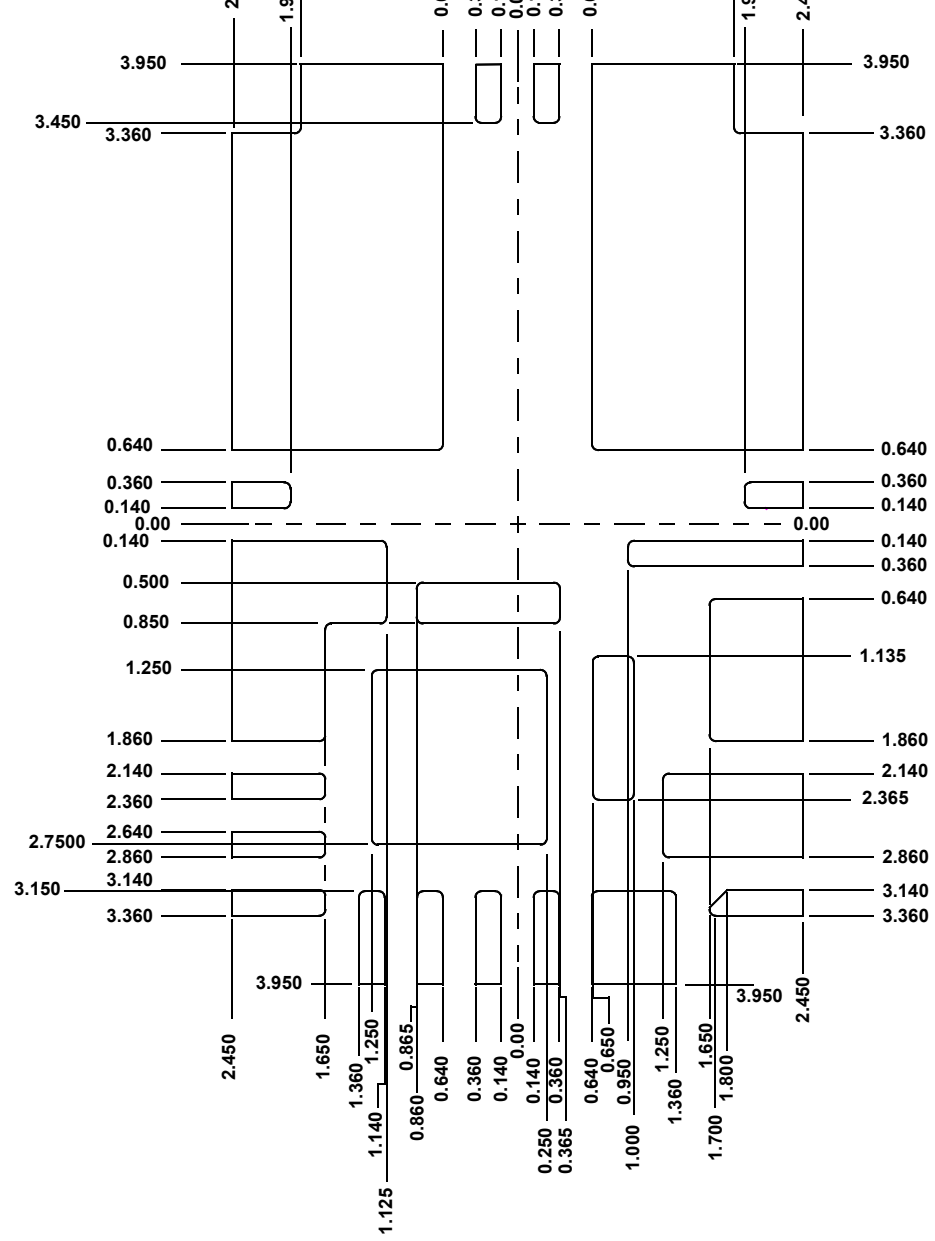

PCB LAND PATTERN

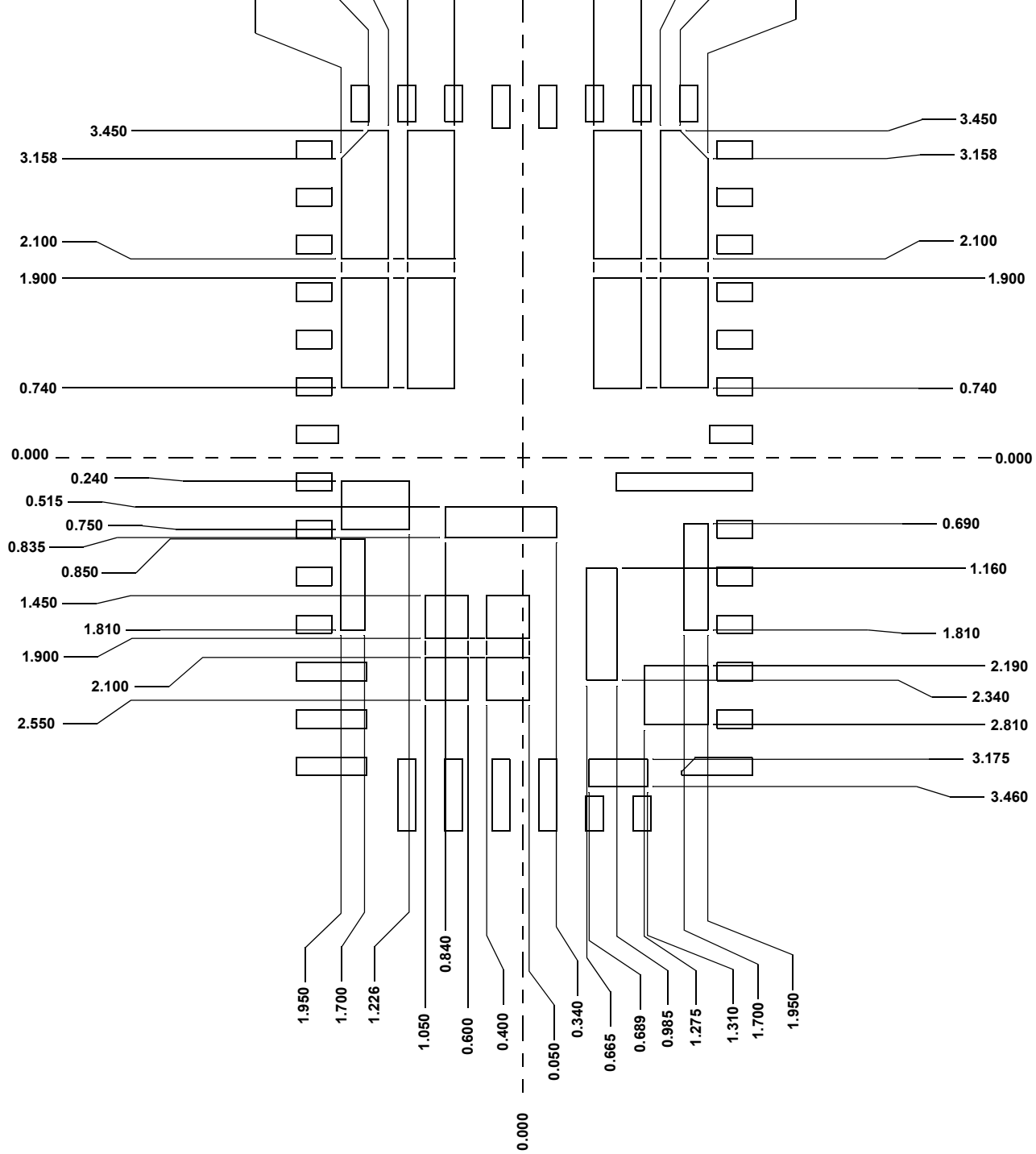

RECOMMENDED STENCIL INTERIOR PADS

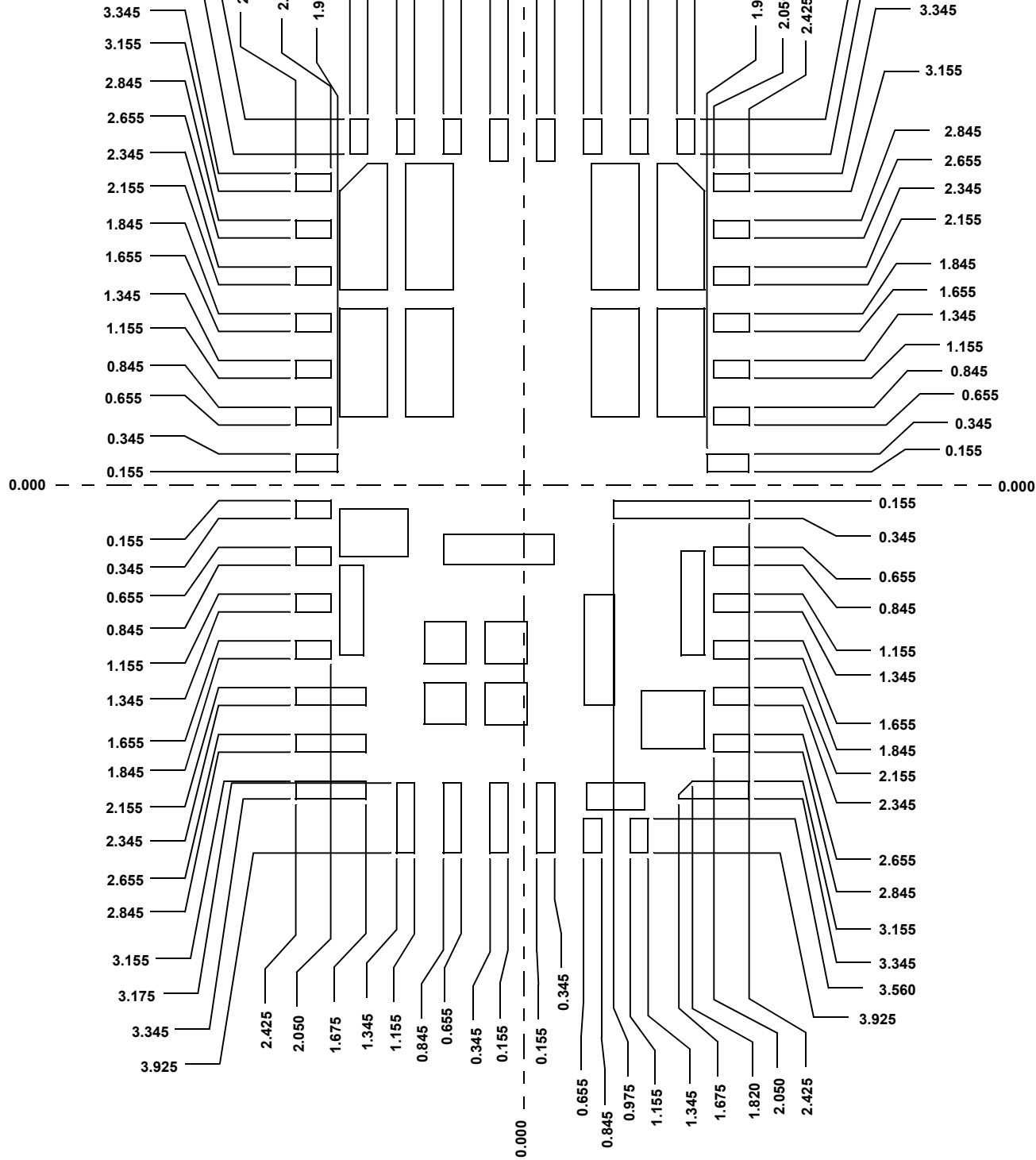

RECOMMENDED STENCIL PERIMETER PADS

## IMPORTANT NOTICE AND DISCLAIMER

RENESAS ELECTRONICS CORPORATION AND ITS SUBSIDIARIES (“RENESAS”) PROVIDES TECHNICAL SPECIFICATIONS AND RELIABILITY DATA (INCLUDING DATASHEETS), DESIGN RESOURCES (INCLUDING REFERENCE DESIGNS), APPLICATION OR OTHER DESIGN ADVICE, WEB TOOLS, SAFETY INFORMATION, AND OTHER RESOURCES “AS IS” AND WITH ALL FAULTS, AND DISCLAIMS ALL WARRANTIES, EXPRESS OR IMPLIED, INCLUDING, WITHOUT LIMITATION, ANY IMPLIED WARRANTIES OF MERCHANTABILITY, FITNESS FOR A PARTICULAR PURPOSE, OR NON-INFRINGEMENT OF THIRD-PARTY INTELLECTUAL PROPERTY RIGHTS.

These resources are intended for developers who are designing with Renesas products. You are solely responsible for (1) selecting the appropriate products for your application, (2) designing, validating, and testing your application, and (3) ensuring your application meets applicable standards, and any other safety, security, or other requirements. These resources are subject to change without notice. Renesas grants you permission to use these resources only to develop an application that uses Renesas products. Other reproduction or use of these resources is strictly prohibited. No license is granted to any other Renesas intellectual property or to any third-party intellectual property. Renesas disclaims responsibility for, and you will fully indemnify Renesas and its representatives against, any claims, damages, costs, losses, or liabilities arising from your use of these resources. Renesas' products are provided only subject to Renesas' Terms and Conditions of Sale or other applicable terms agreed to in writing. No use of any Renesas resources expands or otherwise alters any applicable warranties or warranty disclaimers for these products.

(Disclaimer Rev.1.01 Jan 2024)

### Corporate Headquarters

TOYOSU FORESIA, 3-2-24 Toyosu,  
Koto-ku, Tokyo 135-0061, Japan  
[www.renesas.com](http://www.renesas.com)

### Trademarks

Renesas and the Renesas logo are trademarks of Renesas Electronics Corporation. All trademarks and registered trademarks are the property of their respective owners.

### Contact Information

For further information on a product, technology, the most up-to-date version of a document, or your nearest sales office, please visit [www.renesas.com/contact-us/](http://www.renesas.com/contact-us/).

## Looking for pricing, stock, or lifecycle information?

Click below to explore more details on WIN SOURCE:

-  [View ISL8205MIRZ-T on WIN SOURCE](#)
-  [Renesas Electronics America](#) Information

## Optimize Your Supply Chain with WIN SOURCE Solutions

-  Global Sourcing Solution
-  Obsolete Management
-  Cost Control Management
-  Shortage Management
-  Alternative Solution
-  Excess Inventory Management