



# THE DATASHEET OF IR2125SPBF



**CURRENT LIMITING SINGLE CHANNEL DRIVER**

**Features**

- Floating channel designed for bootstrap operation Fully operational to +500V Tolerant to negative transient voltage dV/dt immune
- Gate drive supply range from 12 to 18V
- Undervoltage lockout
- Current detection and limiting loop to limit driven power transistor current
- Error lead indicates fault conditions and programs shutdown time
- Output in phase with input
- 2.5V, 5V and 15V input logic compatible
- Also available LEAD-Free

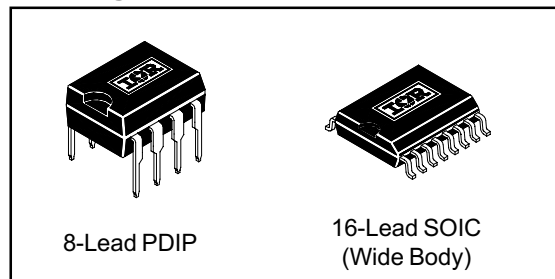
**Description**

The IR2125(S) is a high voltage, high speed power MOSFET and IGBT driver with over-current limiting protection circuitry. Proprietary HVIC and latch immune CMOS technologies enable ruggedized monolithic construction. Logic inputs are compatible with standard CMOS or LSTTL outputs, down to 2.5V logic. The output driver features a high pulse current buffer stage designed for minimum driver cross-conduction. The protection circuitry detects over-current in the driven power transistor and limits the gate drive voltage. Cycle by cycle shutdown is programmed by an external capacitor which directly controls the time interval between detection of the over-current limiting conditions and latched shutdown. The floating channel can be used to drive an N-channel power MOSFET or IGBT in the high or low side configuration which operates up to 500 volts.

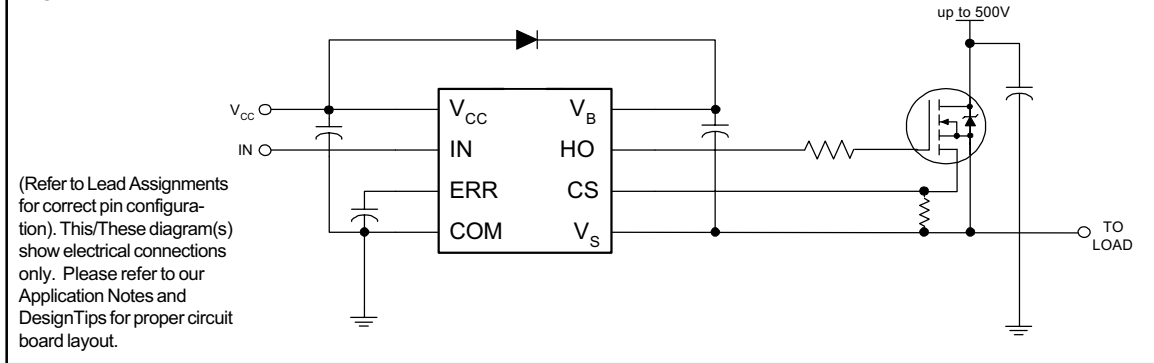
**Product Summary**

<b>V<sub>OFFSET</sub></b>	<b>500V max.</b>
<b>I<sub>O+/-</sub></b>	<b>1A / 2A</b>
<b>V<sub>OUT</sub></b>	<b>12 - 18V</b>
<b>V<sub>Csth</sub></b>	<b>230 mV</b>
<b>ton/off (typ.)</b>	<b>150 &amp; 150 ns</b>

**Packages**



**Typical Connection**



# IR2125(S) & (PbF)

## Absolute Maximum Ratings

Absolute Maximum Ratings indicate sustained limits beyond which damage to the device may occur. All voltage parameters are absolute voltages referenced to COM. The Thermal Resistance and Power Dissipation ratings are measured under board mounted and still air conditions.

Symbol	Definition	Min.	Max.	Units
V <sub>B</sub>	High Side Floating Supply Voltage	-0.3	525	V
V <sub>S</sub>	High Side Floating Offset Voltage	V <sub>B</sub> - 25	V <sub>B</sub> + 0.3	
V <sub>HO</sub>	High Side Floating Output Voltage	V <sub>S</sub> - 0.3	V <sub>B</sub> + 0.3	
V <sub>CC</sub>	Logic Supply Voltage	-0.3	25	
V <sub>IN</sub>	Logic Input Voltage	-0.3	V <sub>CC</sub> + 0.3	
V <sub>ERR</sub>	Error Signal Voltage	-0.3	V <sub>CC</sub> + 0.3	
V <sub>CS</sub>	Current Sense Voltage	V <sub>S</sub> - 0.3	V <sub>B</sub> + 0.3	
dV <sub>S</sub> /dt	Allowable Offset Supply Voltage Transient	—	50	V/ns
P <sub>D</sub>	Package Power Dissipation @ T <sub>A</sub> ≤ +25°C (8 lead PDIP)	—	1.0	W
	(16 lead SOIC)	—	1.25	
R <sub>thJA</sub>	Thermal Resistance, Junction to Ambient (8 lead PDIP)	—	125	°C/W
	(16Lead SOIC)	—	100	
T <sub>J</sub>	Junction Temperature	—	150	°C
T <sub>S</sub>	Storage Temperature	-55	150	
T <sub>L</sub>	Lead Temperature (Soldering, 10 seconds)	—	300	

## Recommended Operating Conditions

The Input/Output logic timing diagram is shown in Figure 1. For proper operation the device should be used within the recommended conditions. The V<sub>S</sub> offset rating is tested with all supplies biased at 15V differential.

Symbol	Definition	Min.	Max.	Units
V <sub>B</sub>	High Side Floating Supply Voltage	V <sub>S</sub> + 12	V <sub>S</sub> + 18	V
V <sub>S</sub>	High Side Floating Offset Voltage	Note 1	500	
V <sub>HO</sub>	High Side Floating Output Voltage	V <sub>S</sub>	V <sub>B</sub>	
V <sub>CC</sub>	Logic Supply Voltage	0	18	
V <sub>IN</sub>	Logic Input Voltage	0	V <sub>CC</sub>	
V <sub>ERR</sub>	Error Signal Voltage	0	V <sub>CC</sub>	
V <sub>CS</sub>	Current Sense Signal Voltage	V <sub>S</sub>	V <sub>B</sub>	
T <sub>A</sub>	Ambient Temperature	-40	125	°C

**Note 1:** Logic operational for V<sub>S</sub> of -5 to +500V. Logic state held for V<sub>S</sub> of -5V to -V<sub>BS</sub>. (Please refer to the Design Tip DT97-3 for more details).

### Dynamic Electrical Characteristics

$V_{BIAS} (V_{CC}, V_{BS}) = 15V$ ,  $C_L = 3300 \text{ pF}$  and  $T_A = 25^\circ\text{C}$  unless otherwise specified. The dynamic electrical characteristics are measured using the test circuit shown in Figures 3 through 6.

Symbol	Definition	Figure	Min.	Typ.	Max.	Units	Test Conditions
$t_{on}$	Turn-On Propagation Delay	7	—	170	240	ns	$V_{IN} = 0 \text{ \& } 5V$ $V_S = 0 \text{ to } 600V$
$t_{off}$	Turn-Off Propagation Delay	8	—	200	270		
$t_{sd}$	ERR Shutdown Propagation Delay	9	—	1.7	2.2	$\mu\text{s}$	
$t_r$	Turn-On Rise Time	10	—	43	60	ns	
$t_f$	Turn-Off Fall Time	11	—	26	35		
$t_{cs}$	CS Shutdown Propagation Delay	12	—	0.7	1.2	$\mu\text{s}$	
$t_{err}$	CS to ERR Pull-Up Propagation Delay	13	—	9.0	12		$C_{ERR} = 270 \text{ pF}$

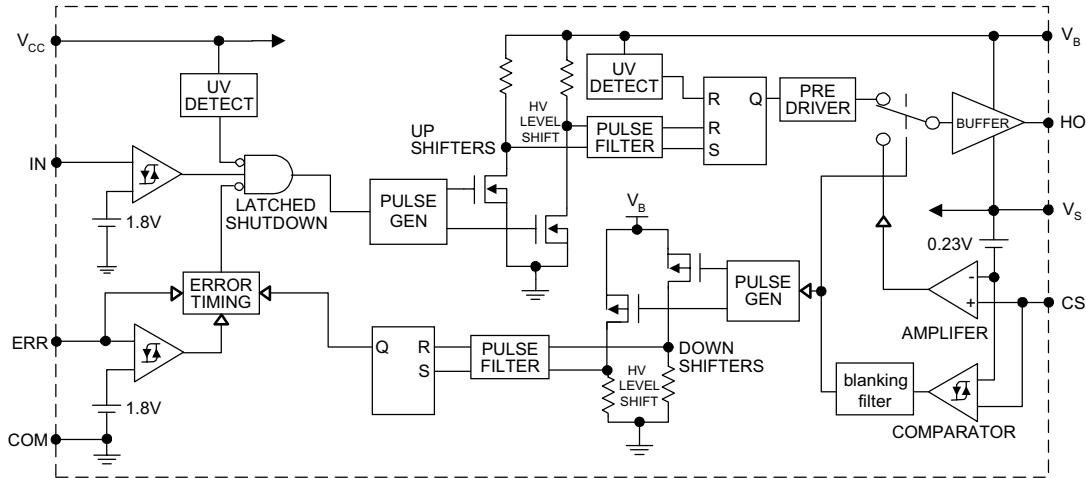
### Static Electrical Characteristics

$V_{BIAS} (V_{CC}, V_{BS}) = 15V$  and  $T_A = 25^\circ\text{C}$  unless otherwise specified. The  $V_{IN}$ ,  $V_{TH}$  and  $I_{IN}$  parameters are referenced to COM. The  $V_O$  and  $I_O$  parameters are referenced to  $V_S$ .

Symbol	Definition	Figure	Min.	Typ.	Max.	Units	Test Conditions	
$V_{IH}$	Logic "1" Input Voltage	14	2.2	—	—	V		
$V_{IL}$	Logic "0" Input Voltage	15	—	—	0.8			
$V_{CSTH+}$	CS Input Positive Going Threshold	16	150	230	320	mV		
$V_{CSTH-}$	CS Input Negative Going Threshold	17	130	210	300			
$V_{OH}$	High Level Output Voltage, $V_{BIAS} - V_O$	18	—	—	100		$I_O = 0A$	
$V_{OL}$	Low Level Output Voltage, $V_O$	19	—	—	100		$I_O = 0A$	
$I_{LK}$	Offset Supply Leakage Current	20	—	—	50	$\mu\text{A}$	$V_B = V_S = 500V$	
$I_{QBS}$	Quiescent $V_{BS}$ Supply Current	21	—	400	1000		$V_{IN} = V_{CS} = 0V \text{ or } 5V$	
$I_{QCC}$	Quiescent $V_{CC}$ Supply Current	22	—	700	1200		$V_{IN} = V_{CS} = 0V \text{ or } 5V$	
$I_{IN+}$	Logic "1" Input Bias Current	23	—	4.5	10		$V_{IN} = 5V$	
$I_{IN-}$	Logic "0" Input Bias Current	24	—	—	1.0		$V_{IN} = 0V$	
$I_{CS+}$	"High" CS Bias Current	25	—	4.5	10		$V_{CS} = 3V$	
$I_{CS-}$	"Low" CS Bias Current	26	—	—	1.0		$V_{CS} = 0V$	
$V_{BSUV+}$	$V_{BS}$ Supply Undervoltage Positive Going Threshold	27	8.5	9.2	10.0		V	
$V_{BSUV-}$	$V_{BS}$ Supply Undervoltage Negative Going Threshold	28	7.7	8.3	9.0			
$V_{CCUV+}$	$V_{CC}$ Supply Undervoltage Positive Going Threshold	29	8.3	8.9	9.6			
$V_{CCUV-}$	$V_{CC}$ Supply Undervoltage Negative Going Threshold	30	7.3	8.0	8.7			
$I_{ERR}$	ERR Timing Charge Current	31	65	100	130	$\mu\text{A}$	$V_{IN} = 5V, V_{CS} = 3V$ $ERR < V_{ERR+}$	
$I_{ERR+}$	ERR Pull-Up Current	32	8.0	15	—	mA	$V_{IN} = 5V, V_{CS} = 3V$ $ERR > V_{ERR+}$	
$I_{ERR-}$	ERR Pull-Down Current	33	16	30	—		$V_{IN} = 0V$	
$I_{O+}$	Output High Short Circuit Pulsed Current	34	1.0	1.6	—	A	$V_O = 0V, V_{IN} = 5V$ $PW \leq 10 \mu\text{s}$	
$I_{O-}$	Output Low Short Circuit Pulsed Current	35	2.0	3.3	—		$V_O = 15V, V_{IN} = 0V$ $PW \leq 10 \mu\text{s}$	

# IR2125(S) & (PbF)

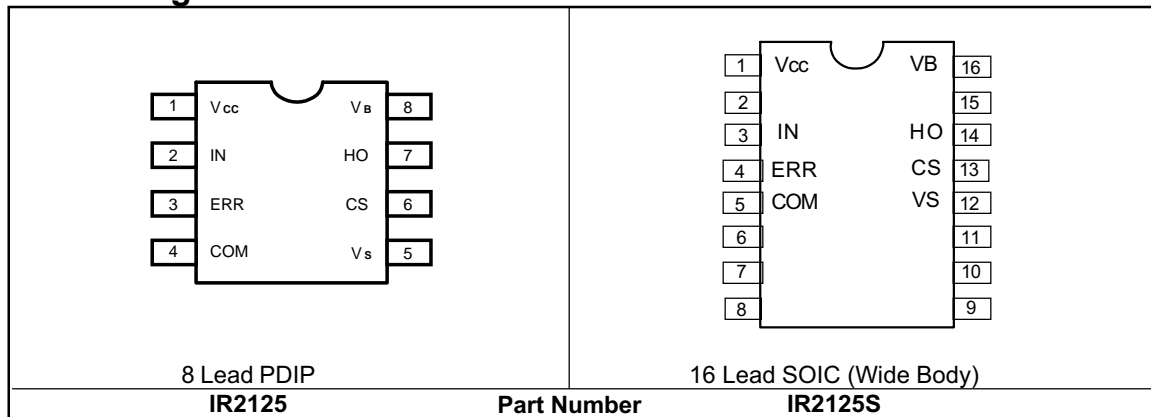
## Functional Block Diagram



## Lead Definitions

Symbol	Description
V <sub>CC</sub>	Logic and gate drive supply
IN	Logic input for gate driver output (HO), in phase with HO
ERR	Serves multiple functions; status reporting, linear mode timing and cycle by cycle logic shutdown
COM	Logic ground
V <sub>B</sub>	High side floating supply
HO	High side gate drive output
V <sub>S</sub>	High side floating supply return
CS	Current sense input to current sense comparator

## Lead Assignments



# IR2125(S) & (PbF)

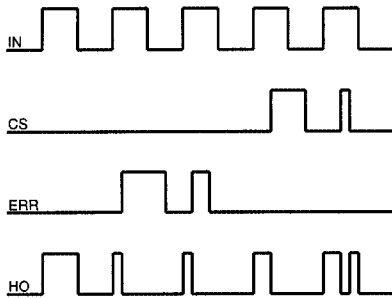


Figure 1. Input/Output Timing Diagram

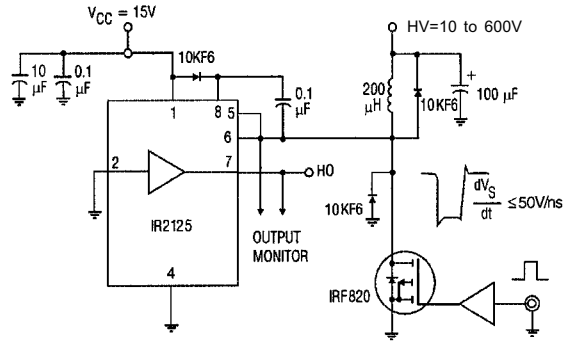


Figure 2. Floating Supply Voltage Transient Test Circuit

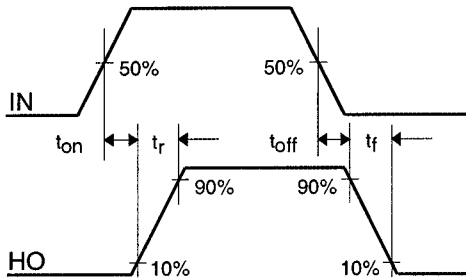


Figure 3. Switching Time Waveform Definitions

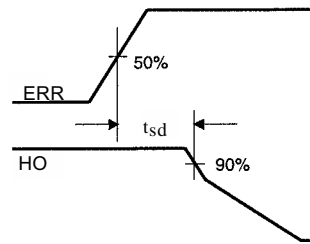


Figure 4. ERR Shutdown Waveform Definitions

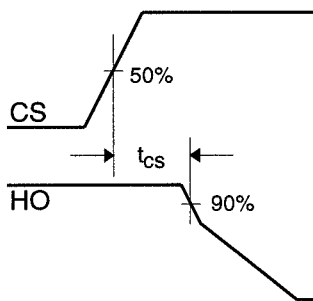


Figure 5. CS Shutdown Waveform Definitions

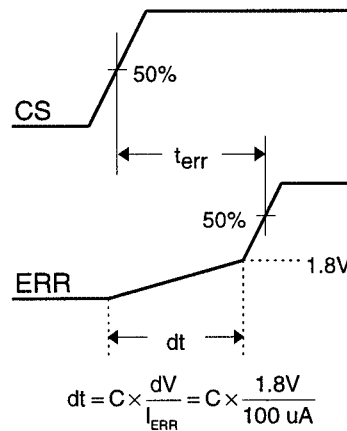


Figure 6. CS to ERR Waveform Definitions

# IR2125(S) & (PbF)

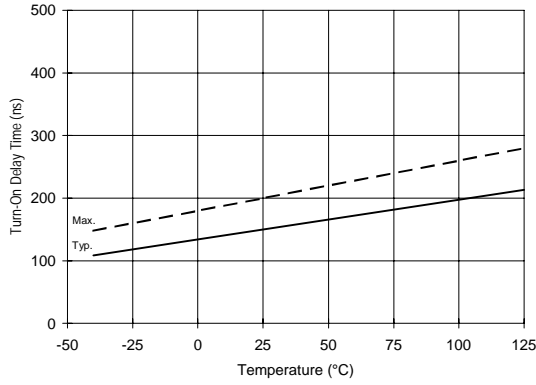


Figure 7A. Turn-On Time vs. Temperature

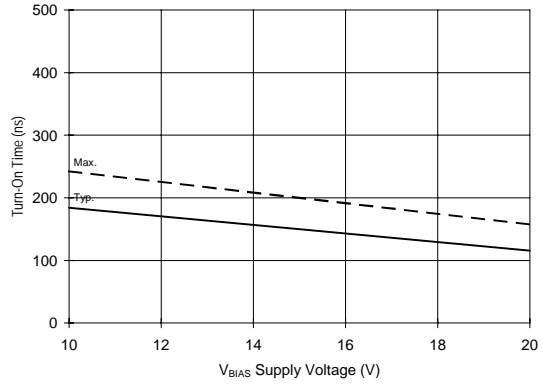


Figure 7B. Turn-On Time vs. Voltage

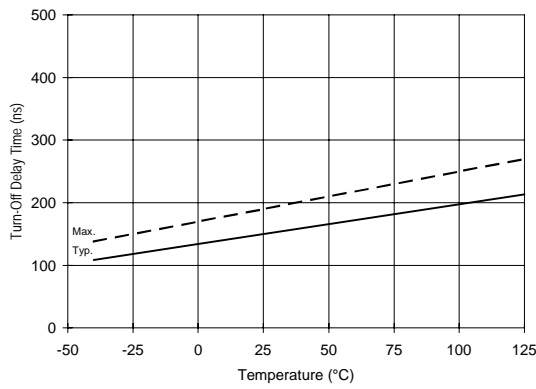


Figure 8A. Turn-Off Time vs. Temperature

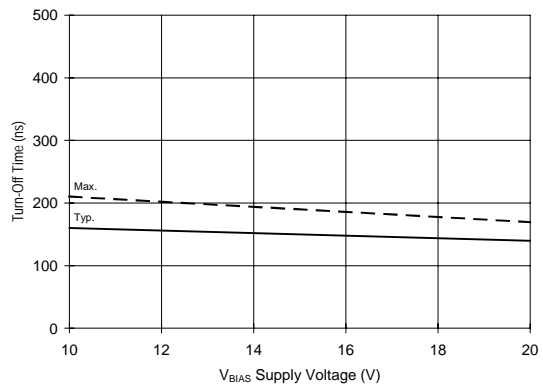


Figure 8B. Turn-Off Time vs. Voltage

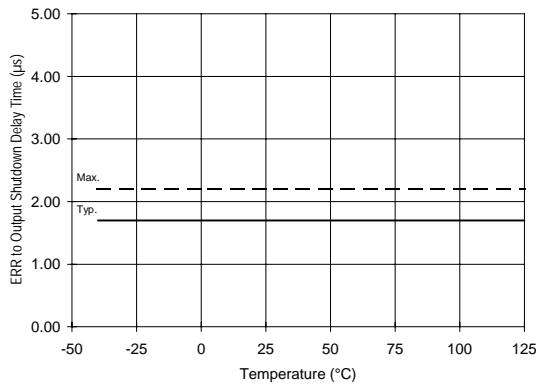


Figure 9A. ERR to Output Shutdown vs. Temperature

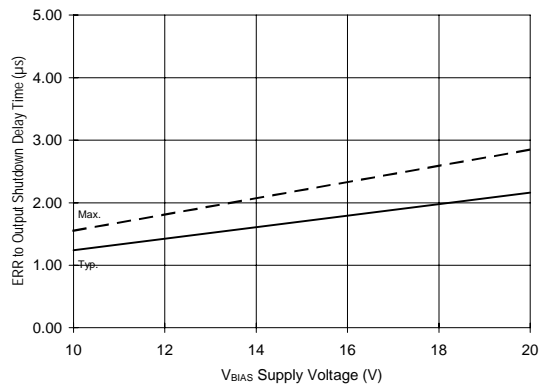


Figure 9B. ERR to Output Shutdown vs. Voltage

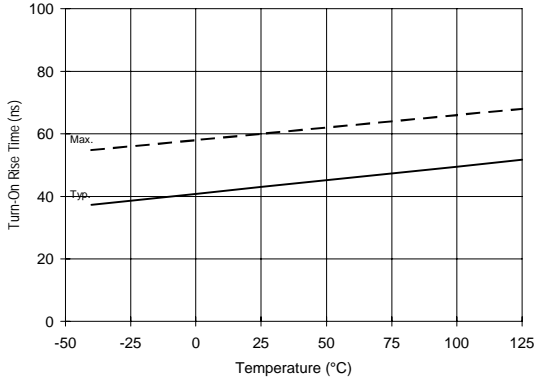


Figure 10A. Turn-On Rise Time vs. Temperature

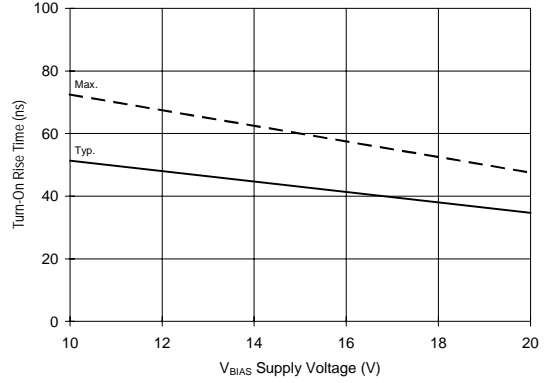


Figure 10B. Turn-On Rise Time vs. Voltage

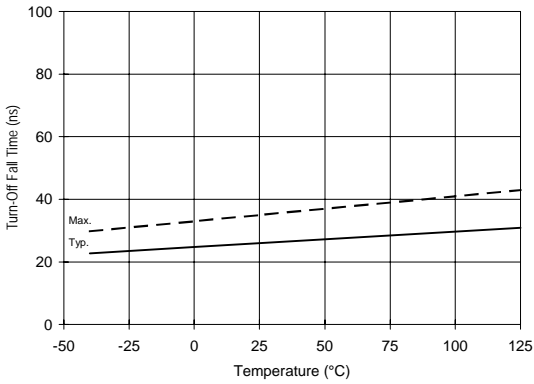


Figure 11A. Turn-Off Fall Time vs. Temperature

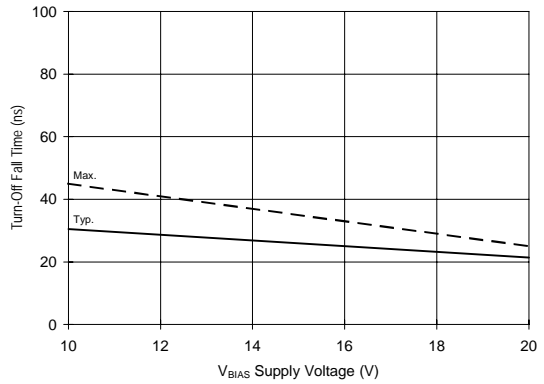


Figure 11B. Turn-Off Fall Time vs. Voltage

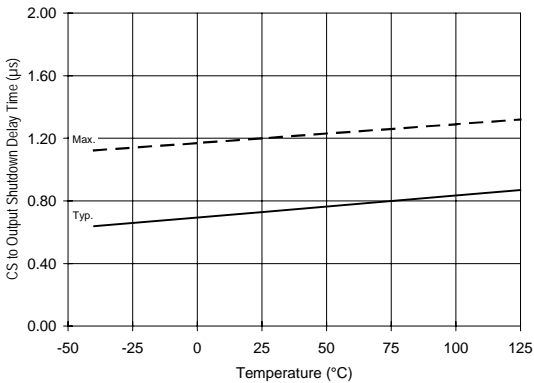


Figure 12A. CS to Output Shutdown vs. Temperature

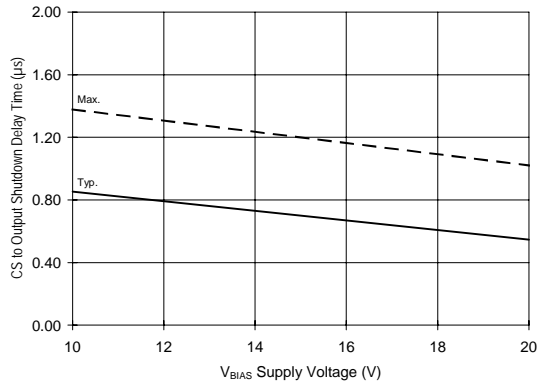
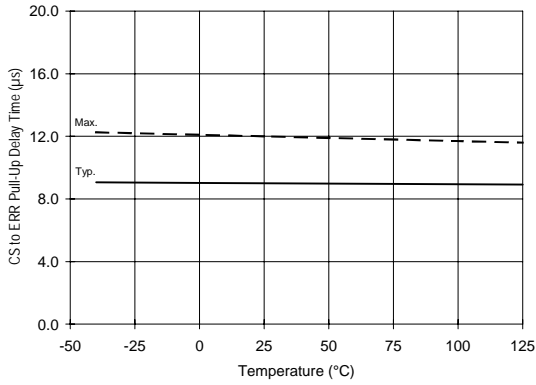
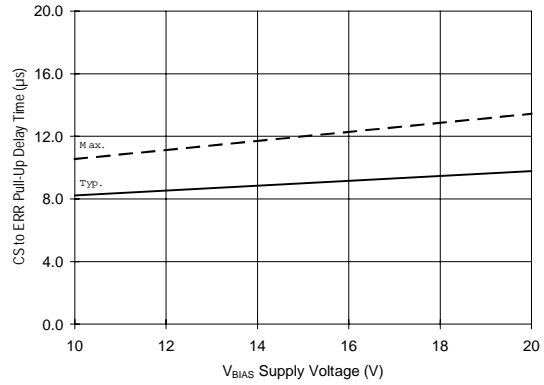


Figure 12B. CS to Output Shutdown vs. Voltage

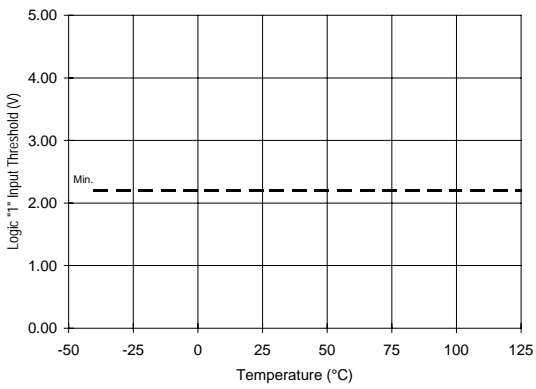
# IR2125(S) & (PbF)



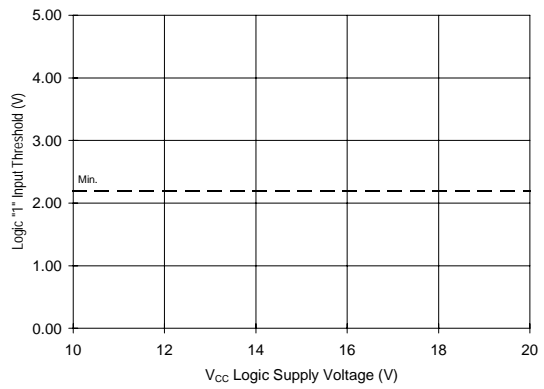
**Figure 13A. CS to ERR Pull-Up vs. Temperature**



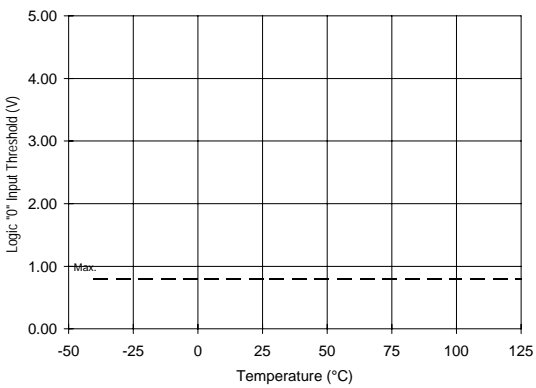
**Figure 13B. CS to ERR Pull-Up vs. Voltage**



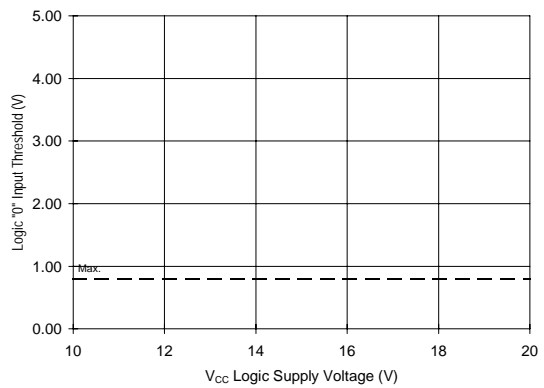
**Figure 14A. Logic "1" Input Threshold vs. Temperature**



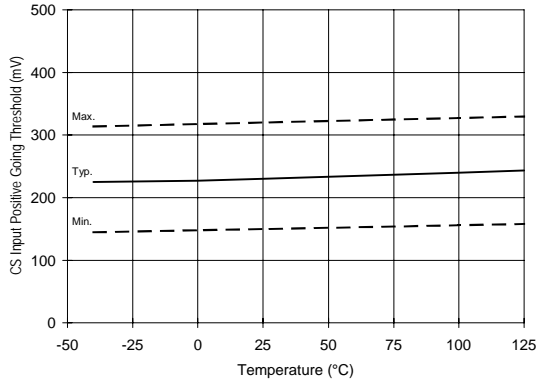
**Figure 14B. Logic "1" Input Threshold vs. Voltage**



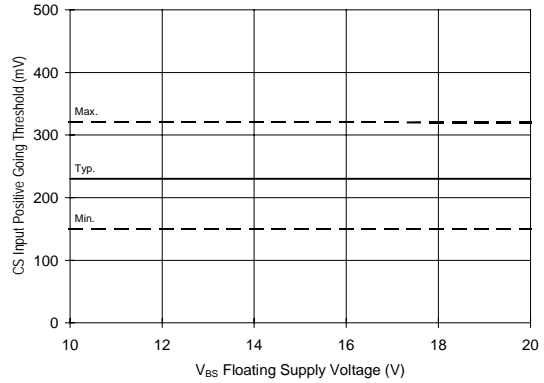
**Figure 15A. Logic "0" Input Threshold vs. Temperature**



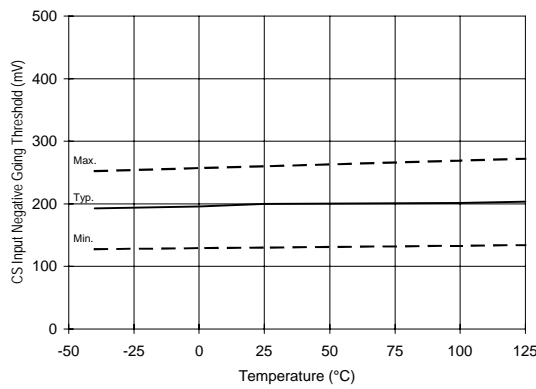
**Figure 15B. Logic "0" Input Threshold vs. Voltage**



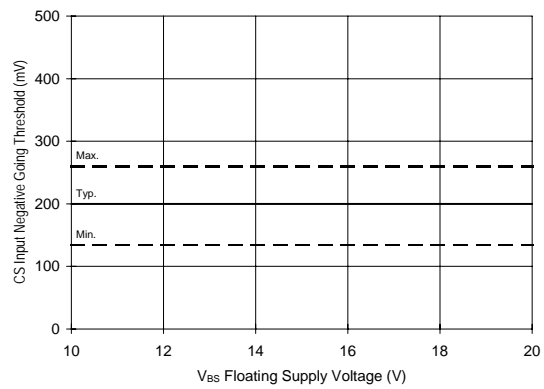
**Figure 16A. CS Input Threshold (+) vs. Temperature**



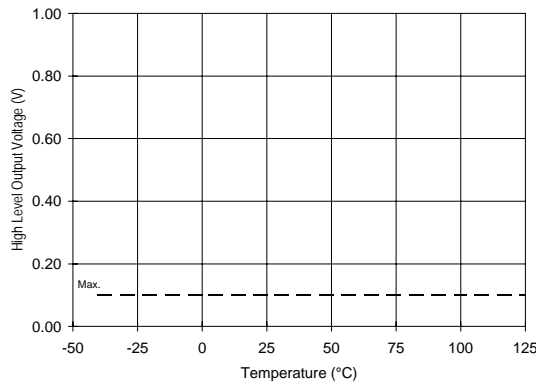
**Figure 16B. CS Input Threshold (+) vs. Voltage**



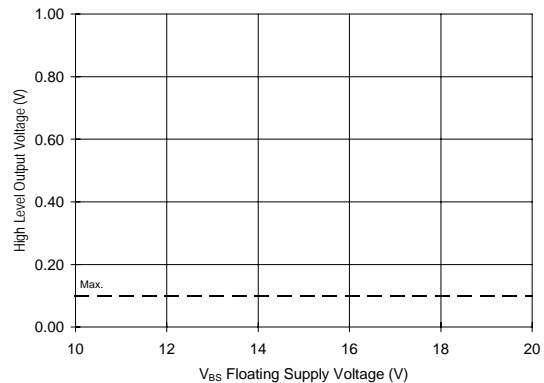
**Figure 17A. CS Input Threshold (-) vs. Temperature**



**Figure 17B. CS Input Threshold (-) vs. Voltage**

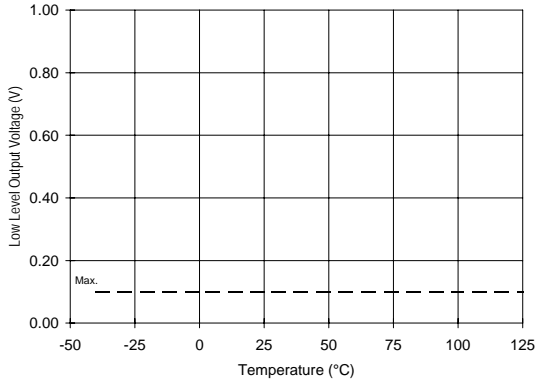


**Figure 18A. High Level Output vs. Temperature**

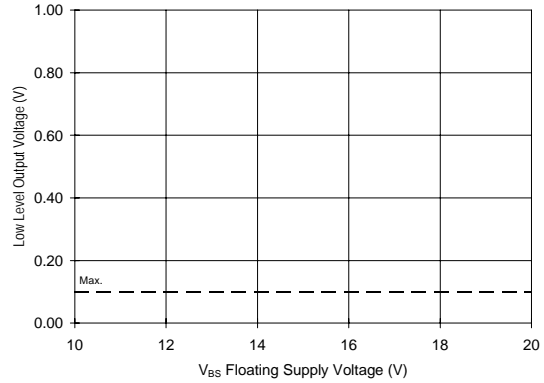


**Figure 18B. High Level Output vs. Voltage**

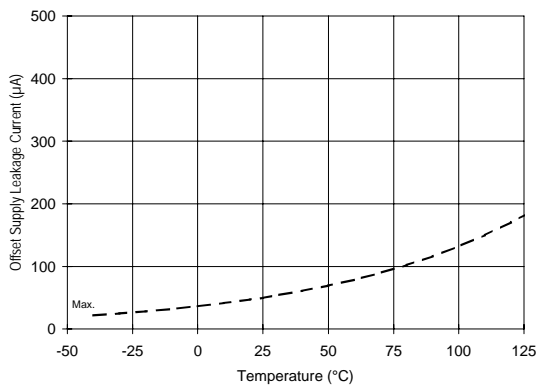
# IR2125(S) & (PbF)



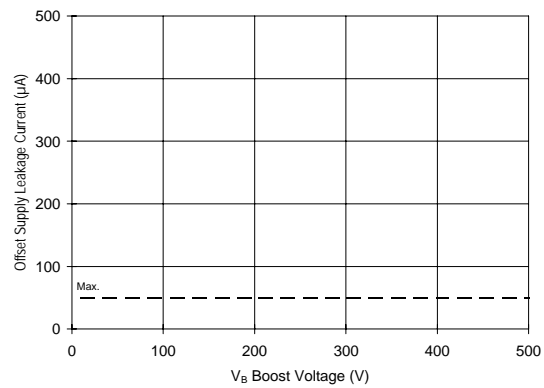
**Figure 19A. Low Level Output vs. Temperature**



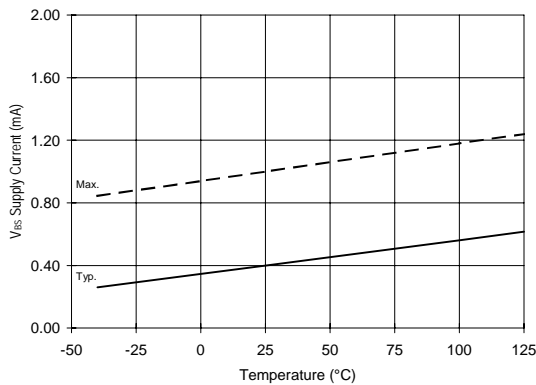
**Figure 19B. Low Level Output vs. Voltage**



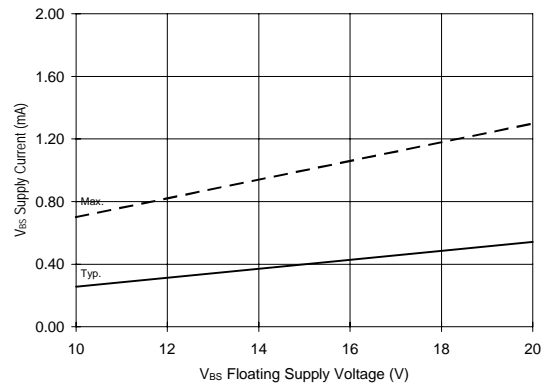
**Figure 20A. Offset Supply Current vs. Temperature**



**Figure 20B. Offset Supply Current vs. Voltage**



**Figure 21A. V<sub>BS</sub> Supply Current vs. Temperature**



**Figure 21B. V<sub>BS</sub> Supply Current vs. Voltage**

# IR2125(S) & (PbF)

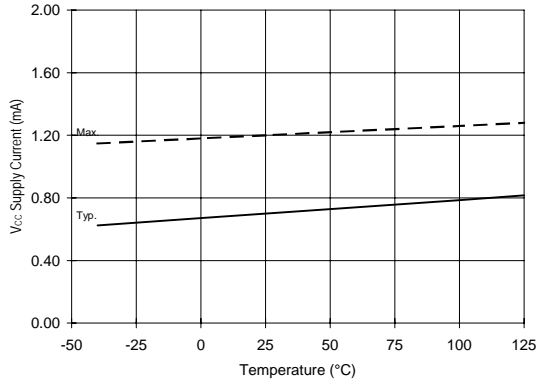


Figure 22A. V<sub>CC</sub> Supply Current vs. Temperature

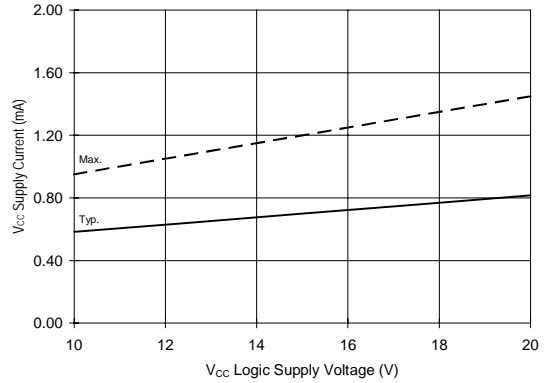


Figure 22B. V<sub>CC</sub> Supply Current vs. Voltage

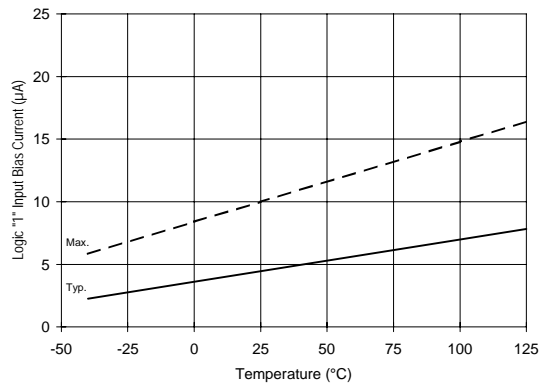


Figure 23A. Logic "1" Input Current vs. Temperature

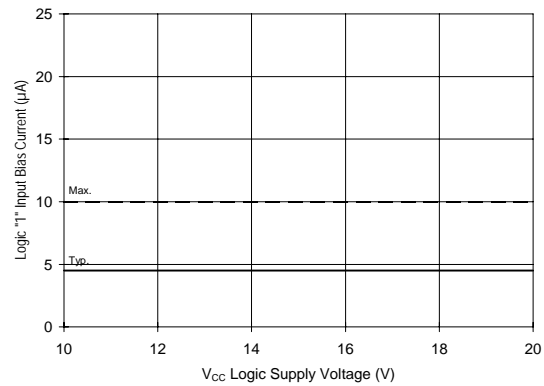


Figure 23B. Logic "1" Input Current vs. Voltage

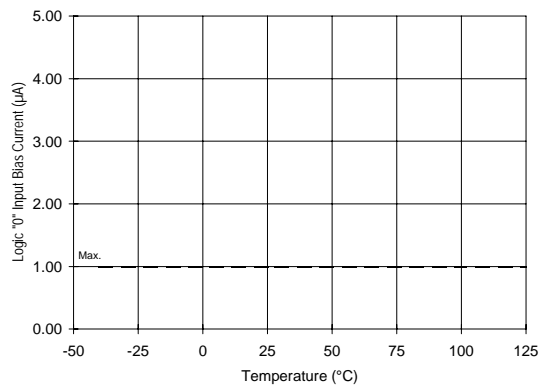


Figure 24A. Logic "0" Input Current vs. Temperature

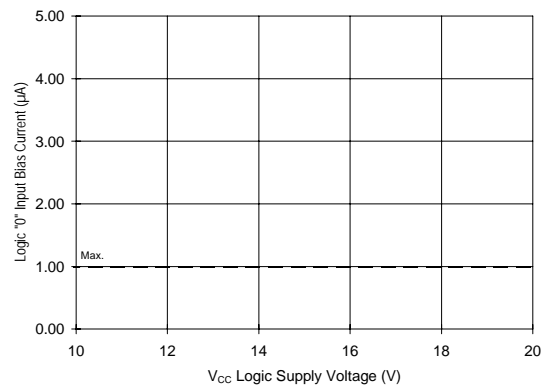
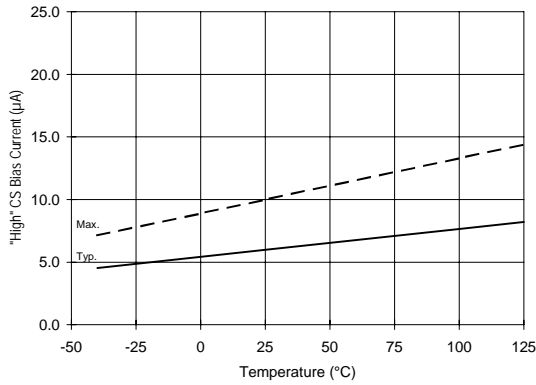
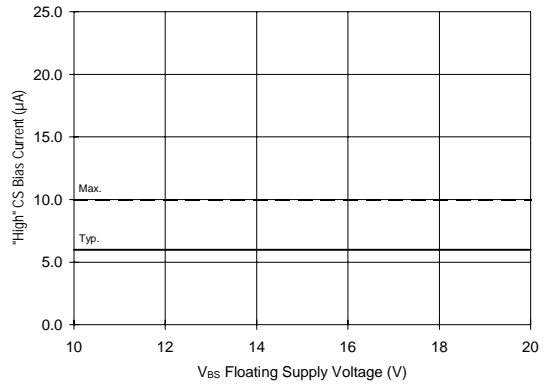


Figure 24B. Logic "0" Input Current vs. Voltage

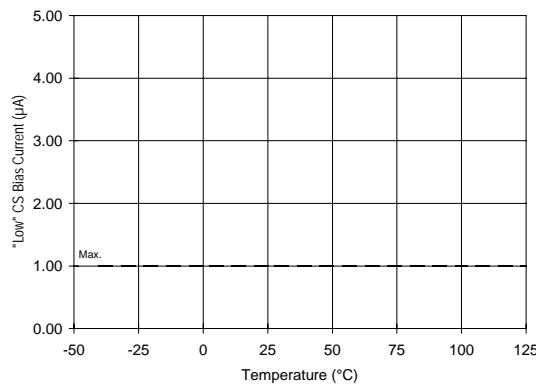
# IR2125(S) & (PbF)



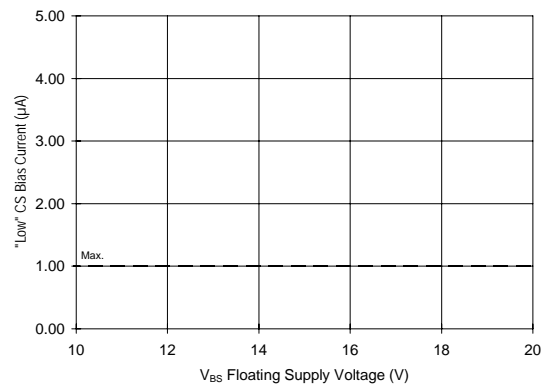
**Figure 25A. “High” CS Bias Current vs. Temperature**



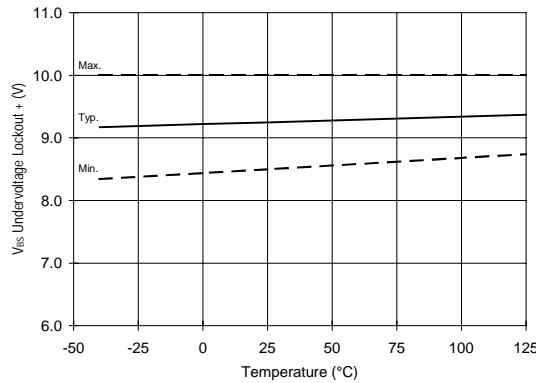
**Figure 25B. “High” CS Bias Current vs. Voltage**



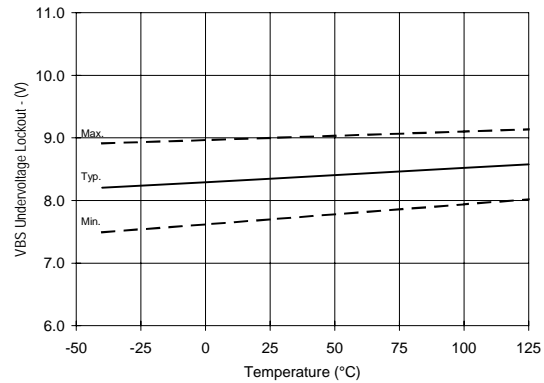
**Figure 26A. “Low” CS Bias Current vs. Temperature**



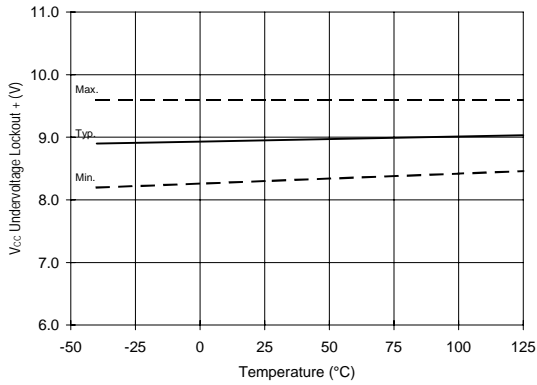
**Figure 26B. “Low” CS Bias Current vs. Voltage**



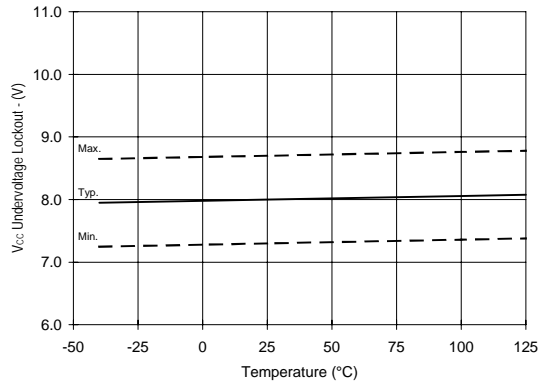
**Figure 27. V<sub>BS</sub> Undervoltage Lockout (+) vs. Temperature**



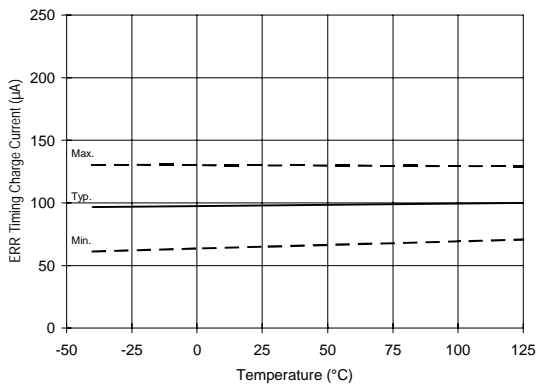
**Figure 28. V<sub>BS</sub> Undervoltage Lockout (-) vs. Temperature**



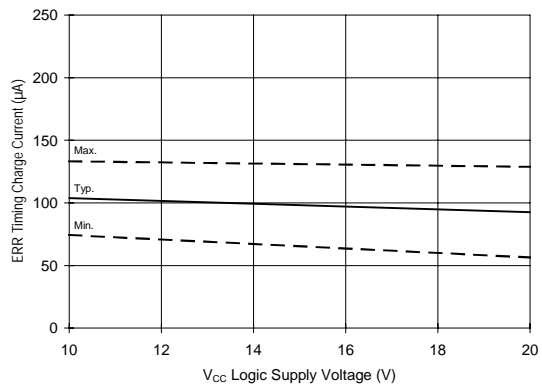
**Figure 29. V<sub>CC</sub> Undervoltage (+) vs. Temperature**



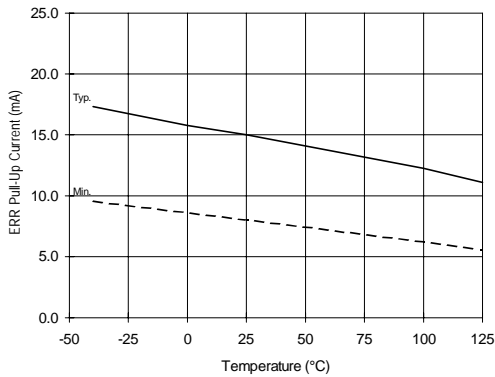
**Figure 30. V<sub>CC</sub> Undervoltage (-) vs. Temperature**



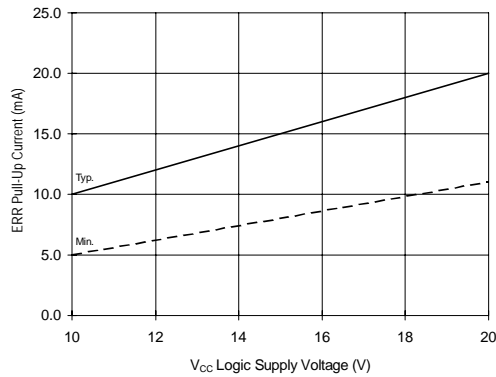
**Figure 31A. ERR Timing Charge Current vs. Temperature**



**Figure 31B. ERR Timing Charge Current vs. Voltage**



**Figure 32A. ERR Pull-Up Current vs. Temperature**



**Figure 32B. ERR Pull-Up Current vs. Voltage**

# IR2125(S) & (PbF)

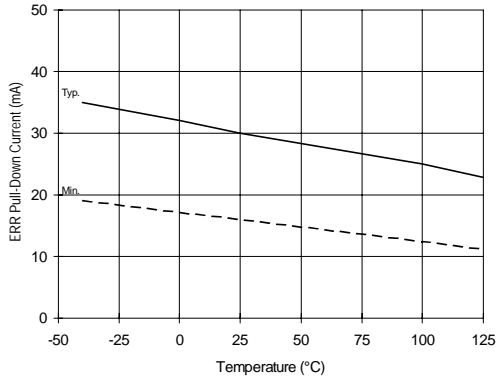


Figure 33A. ERR Pull-Down Current vs. Temperature

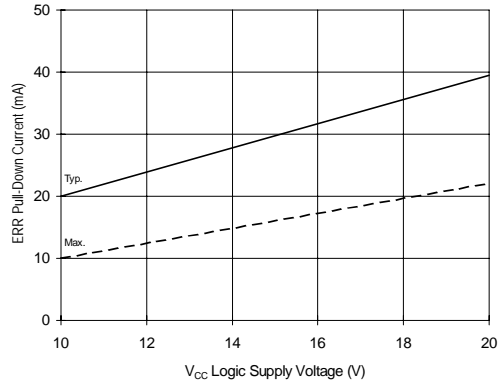


Figure 33B. ERR Pull-Down Current vs. Voltage

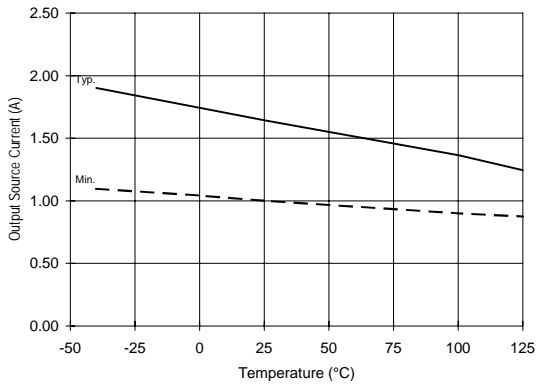


Figure 34A. Output Source Current vs. Temperature

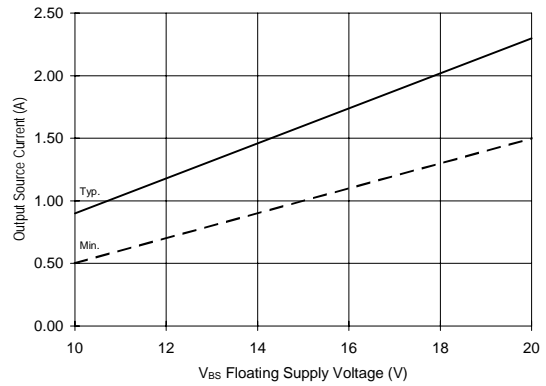


Figure 34B. Output Source Current vs. Voltage

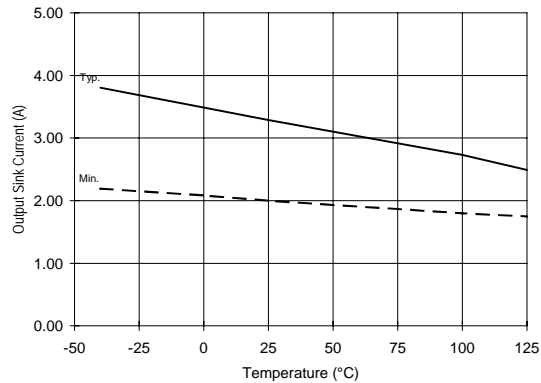


Figure 35A. Output Sink Current vs. Temperature

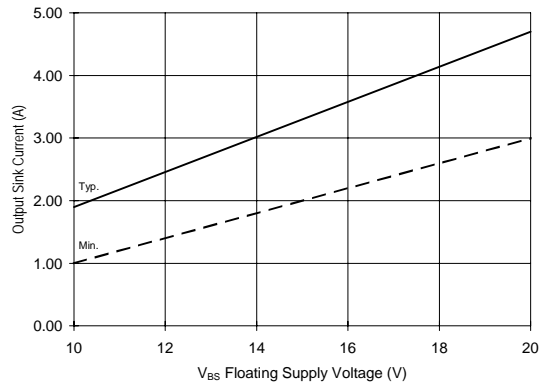
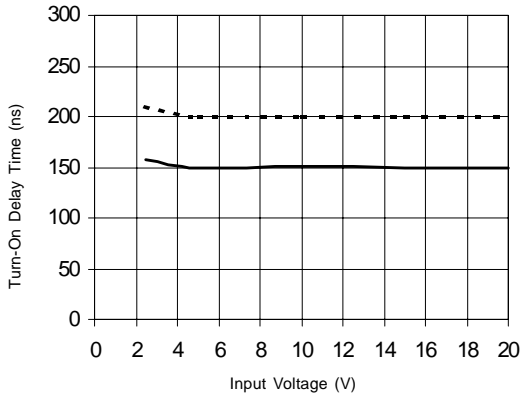
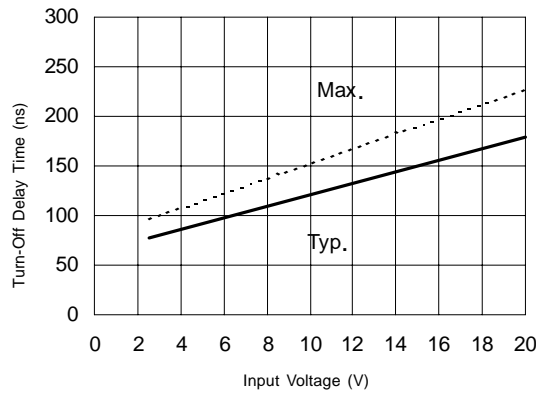


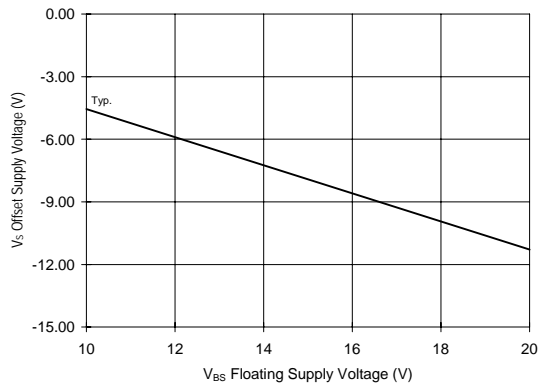
Figure 35B. Output Sink Current vs. Voltage



**Figure 36A. Turn-On Time vs. Input Voltage**



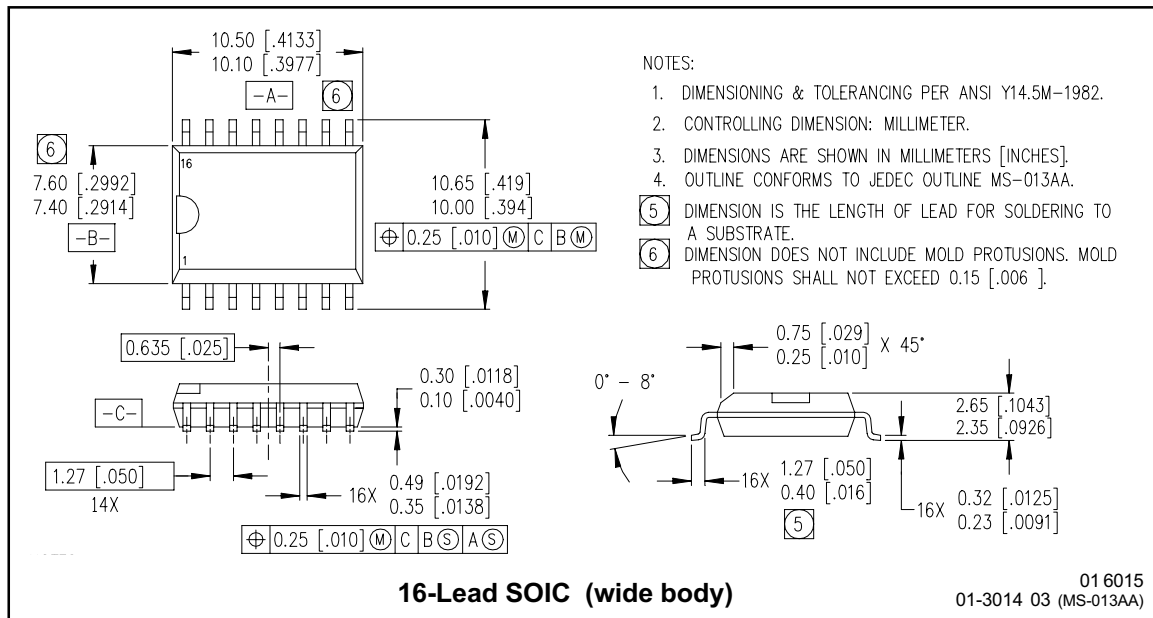
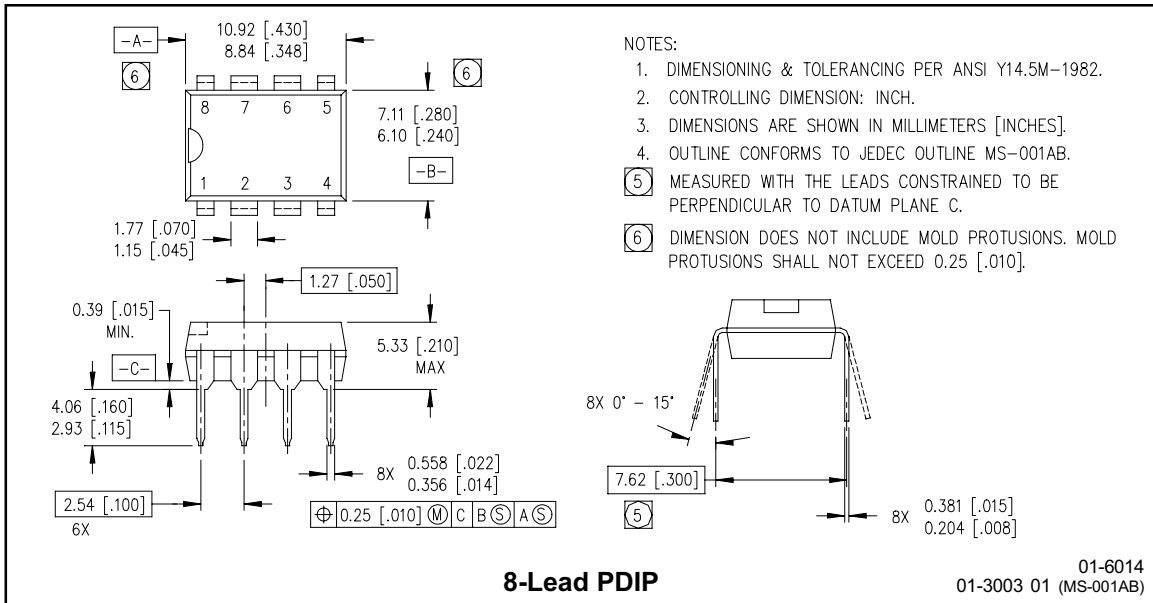
**Figure 36B. Turn-Off Time vs. Input Voltage**



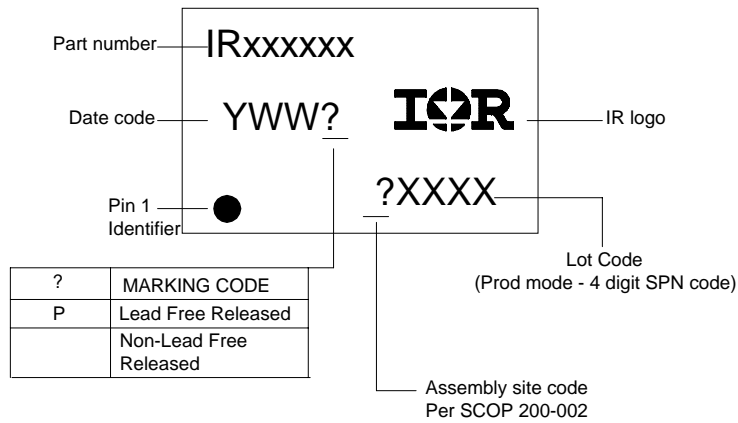
**Figure 37. Maximum V<sub>S</sub> Negative Offset vs. Supply Voltage**

# IR2125(S) & (PbF)

## Case outlines



## LEADFREE PART MARKING INFORMATION



## ORDER INFORMATION

### Basic Part (Non-Lead Free)



8-Lead PDIP IR2125 order IR2125  
 16-Lead SOIC IR2125S order IR2125S

### Leadfree Part

8-Lead PDIP IR2125 order IR2125PbF  
 16-Lead SOIC IR2125S order IR2125SPbF

## Looking for pricing, stock, or lifecycle information?

Click below to explore more details on WIN SOURCE:

-  [View IR2125SPBF on WIN SOURCE](#)
-  [Infineon Technologies](#) Information

## Optimize Your Supply Chain with WIN SOURCE Solutions

-  Global Sourcing Solution
-  Obsolete Management
-  Cost Control Management
-  Shortage Management
-  Alternative Solution
-  Excess Inventory Management