



THE DATASHEET OF IR2105STR



IR2105

HALF BRIDGE DRIVER

Features

- Floating channel designed for bootstrap operation
 Fully operational to +600V
 Tolerant to negative transient voltage
 dV/dt immune
- Gate drive supply range from 10 to 20V
- Undervoltage lockout
- 5V Schmitt-triggered input logic
- Cross-conduction prevention logic
- Internally set deadtime
- High side output in phase with input
- Match propagation delay for both channels

Description

The IR2105 is a high voltage, high speed power MOSFET and IGBT driver with dependent high and low side referenced output channels. Proprietary HVIC and latch immune CMOS technologies enable ruggedized monolithic construction. The logic input is compatible with standard CMOS or LSTTL outputs. The output drivers feature a high pulse current buffer stage designed for minimum driver cross-conduction. The floating channel can be used to drive an N-channel power MOSFET or IGBT in the high side configuration which operates from 10 to 600 volts.

Product Summary

V_{OFFSET}	600V max.
I_{O+/-}	130 mA / 270 mA
V_{OUT}	10 - 20V
t_{on/off} (typ.)	680 & 150 ns
Deadtime (typ.)	520 ns

Packages

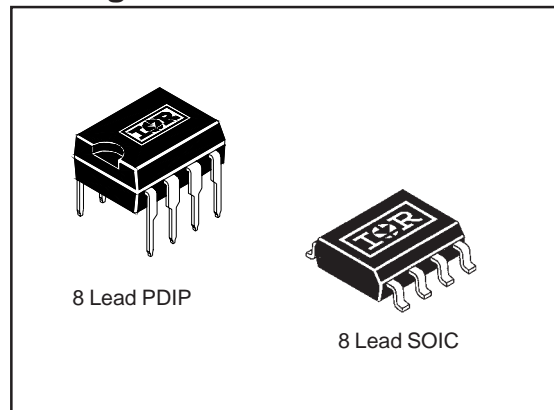

Typical Connection

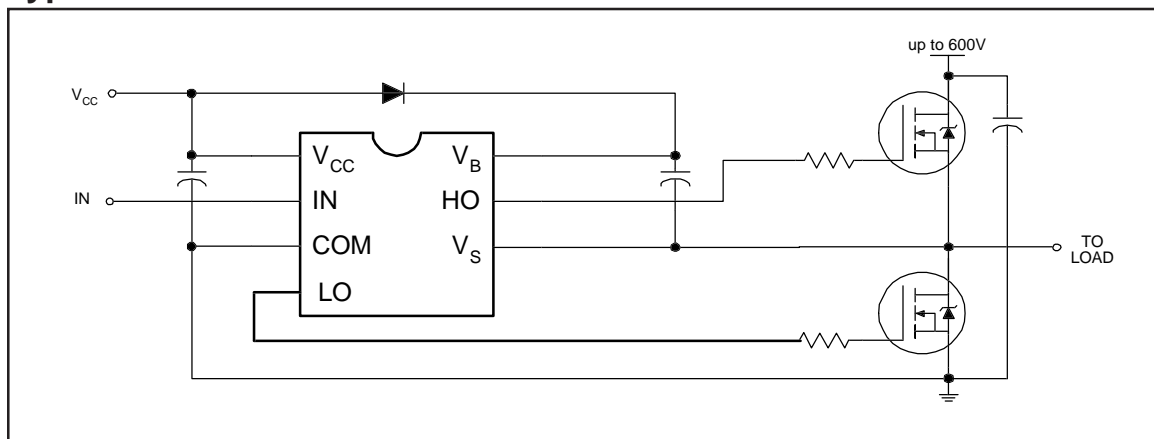

Absolute Maximum Ratings

Absolute maximum ratings indicate sustained limits beyond which damage to the device may occur. All voltage parameters are absolute voltages referenced to COM. The thermal resistance and power dissipation ratings are measured under board mounted and still air conditions.

Symbol	Definition	Min.	Max.	Units	
V _B	High side floating absolute voltage	-0.3	625	V	
V _S	High side floating supply offset voltage	V _B - 25	V _B + 0.3		
V _{HO}	High side floating output voltage	V _S - 0.3	V _B + 0.3		
V _{CC}	Low side and logic fixed supply voltage	-0.3	25		
V _{LO}	Low side output voltage	-0.3	V _{CC} + 0.3		
V _{IN}	Logic input voltage	-0.3	V _{CC} + 0.3		
dV _S /dt	Allowable offset supply voltage transient	—	50	V/ns	
P _D	Package power dissipation @ T _A ≤ +25°C	(8 Lead DIP)	—	1.0	W
		(8 Lead SOIC)	—	0.625	
R _{thJA}	Thermal resistance, junction to ambient	(8 Lead DIP)	—	125	°C/W
		(8 Lead SOIC)	—	200	
T _J	Junction temperature	—	150	°C	
T _S	Storage temperature	-55	150		
T _L	Lead temperature (soldering, 10 seconds)	—	300		

Recommended Operating Conditions

The input/output logic timing diagram is shown in figure 1. For proper operation the device should be used within the recommended conditions. The V_S offset rating is tested with all supplies biased at 15V differential.

Symbol	Definition	Min.	Max.	Units
V _B	High side floating supply absolute voltage	V _S + 10	V _S + 20	V
V _S	High side floating supply offset voltage	Note 1	600	
V _{HO}	High side floating output voltage	V _S	V _B	
V _{CC}	Low side and logic fixed supply voltage	10	20	
V _{LO}	Low side output voltage	0	V _{CC}	
V _{IN}	Logic input voltage	0	V _{CC}	
T _A	Ambient temperature	-40	125	°C

Note 1: Logic operational for V_S of -5 to +600V. Logic state held for V_S of -5V to -V_{BS}.

Dynamic Electrical Characteristics

V_{BIAS} (V_{CC} , V_{BS}) = 15V, C_L = 1000 pF and T_A = 25°C unless otherwise specified.

Symbol	Definition	Min.	Typ.	Max.	Units	Test Conditions
t_{on}	Turn-on propagation delay	—	680	820	ns	$V_S = 0V$
t_{off}	Turn-off propagation delay	—	150	220		$V_S = 600V$
t_r	Turn-on rise time	—	100	170		
t_f	Turn-off fall time	—	50	90		
DT	Deadtime, LS turn-off to HS turn-on & HS turn-on to LS turn-off	400	520	650		
MT	Delay matching, HS & LS turn-on/off	—	—	60		

Static Electrical Characteristics

V_{BIAS} (V_{CC} , V_{BS}) = 15V and T_A = 25°C unless otherwise specified. The V_{IN} , V_{TH} and I_{IN} parameters are referenced to COM. The V_O and I_O parameters are referenced to COM and are applicable to the respective output leads: HO or LO.

Symbol	Definition	Min.	Typ.	Max.	Units	Test Conditions
V_{IH}	Logic "1" (HO) & Logic "0" (LO) Input Voltage	3	—	—	V	$V_{CC} = 10V$ to $20V$
V_{IL}	Logic "0" (HO) & Logic "1" (LO) Input Voltage	—	—	0.8		$V_{CC} = 10V$ to $20V$
V_{OH}	High Level Output Voltage, $V_{BIAS} - V_O$	—	—	100	mV	$I_O = 0A$
V_{OL}	Low Level Output Voltage, V_O	—	—	100		$I_O = 0A$
I_{LK}	Offset Supply Leakage Current	—	—	50	μA	$V_B = V_S = 600V$
I_{QBS}	Quiescent V_{BS} Supply Current	—	30	55		$V_{IN} = 0V$ or $5V$
I_{QCC}	Quiescent V_{CC} Supply Current	—	150	270		$V_{IN} = 0V$ or $5V$
I_{IN+}	Logic "1" Input Bias Current	—	3	10		$V_{IN} = 5V$
I_{IN-}	Logic "0" Input Bias Current	—	—	1		$V_{IN} = 0V$
V_{CCUV+}	V_{CC} Supply Undervoltage Positive Going Threshold	8	8.9	9.8	V	
V_{CCUV-}	V_{CC} Supply Undervoltage Negative Going Threshold	7.4	8.2	9		
I_{O+}	Output High Short Circuit Pulsed Current	130	210	—	mA	$V_O = 0V$ $PW \leq 10 \mu s$
I_{O-}	Output Low Short Circuit Pulsed Current	270	360	—		$V_O = 15V$ $PW \leq 10 \mu s$

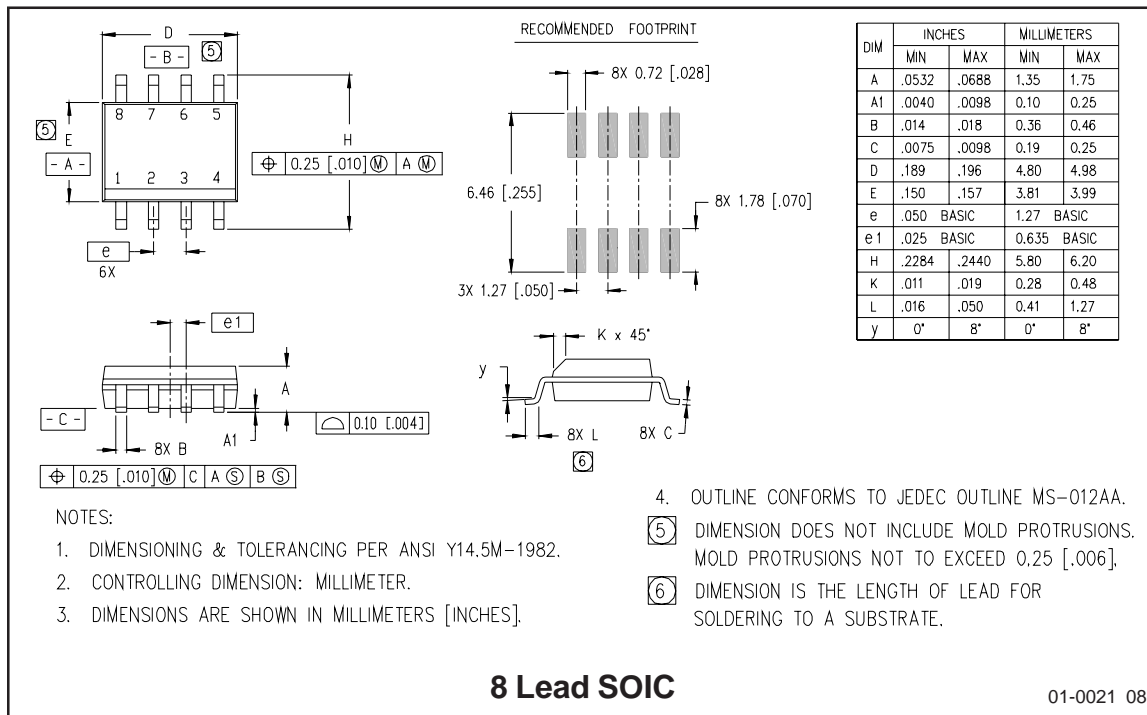
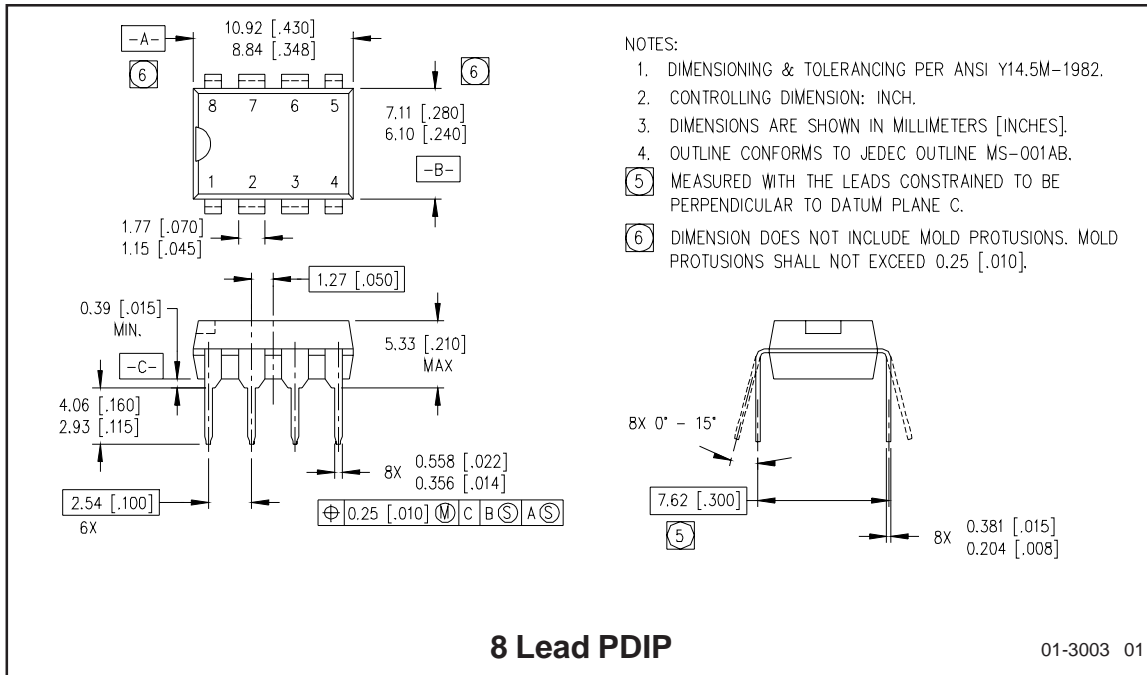

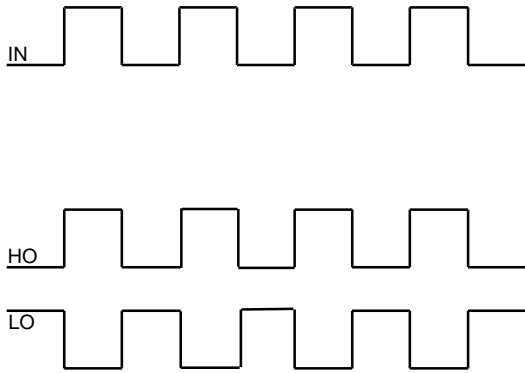

Figure 1. Input/Output Timing Diagram

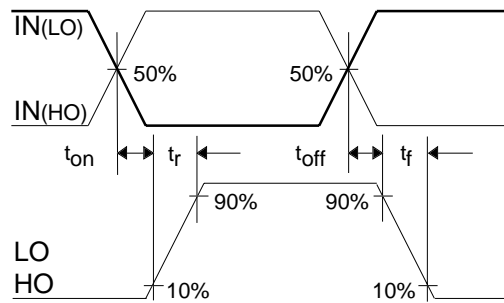

Figure 2. Switching Time Waveform Definitions

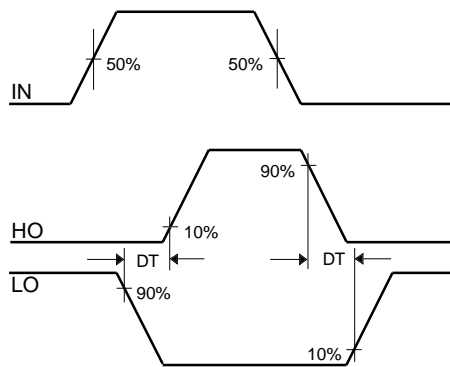

Figure 3. Deadtime Waveform Definitions

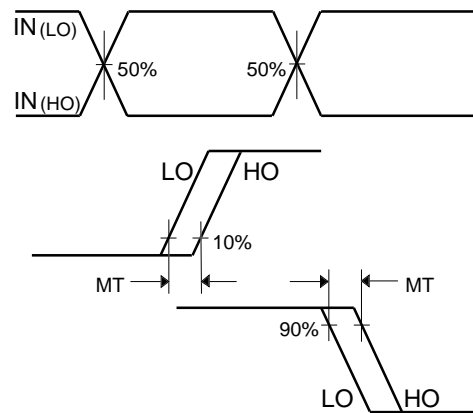

Figure 4. Delay Matching Waveform Definitions

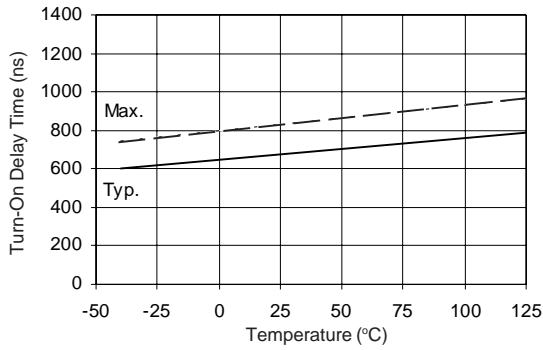

Figure 6A. Turn-On Time vs Temperature

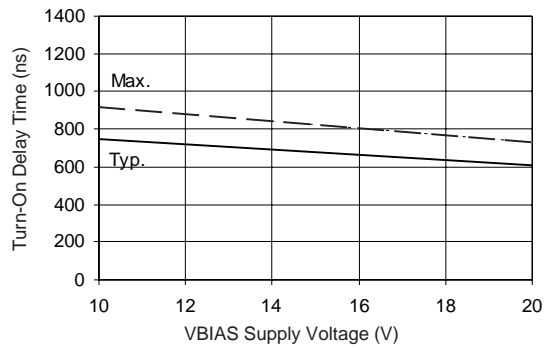

Figure 6B. Turn-On Time vs Voltage

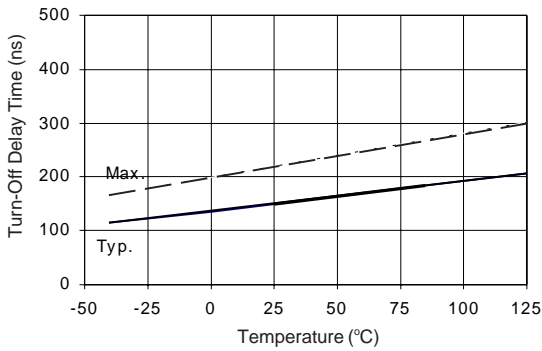

Figure 7A. Turn-Off Time vs Temperature

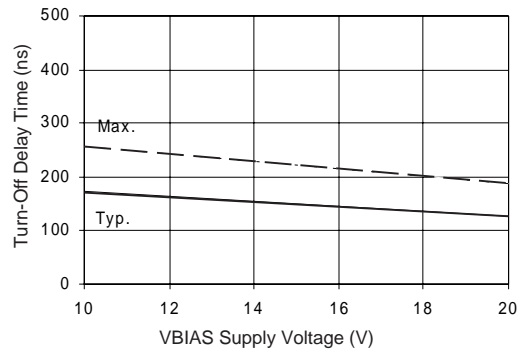

Figure 7B. Turn-Off Time vs Voltage

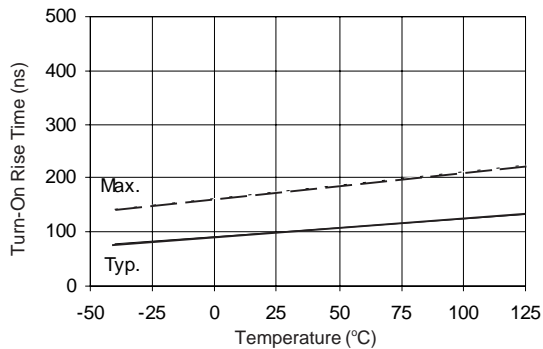

Figure 9A. Turn-On Rise Time vs Temperature

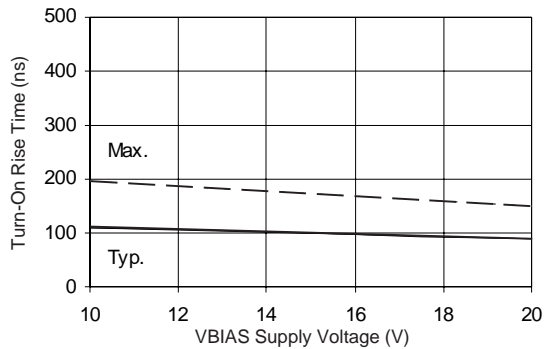

Figure 9B. Turn-On Rise Time vs Voltage

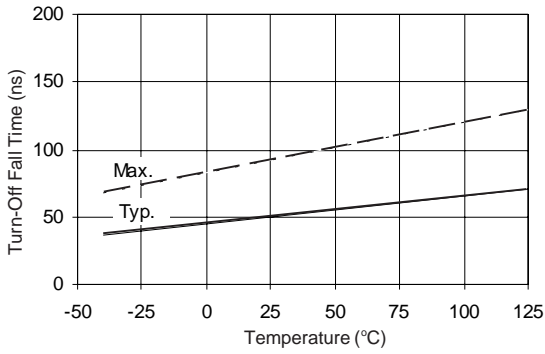

Figure 10A. Turn Off Fall Time vs Temperature

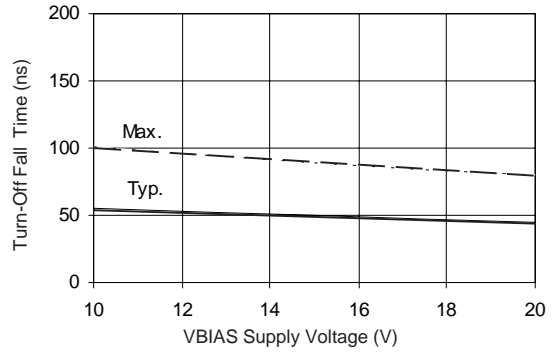

Figure 10B. Turn Off Fall Time vs Voltage

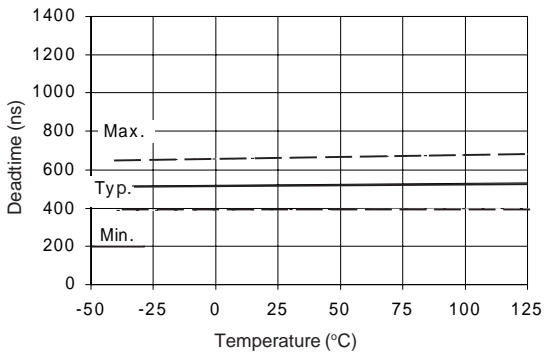

Figure 11A. Deadtime vs Temperature

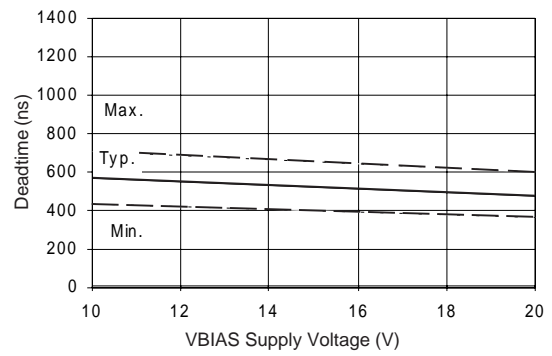

Figure 11B. Deadtime vs Voltage

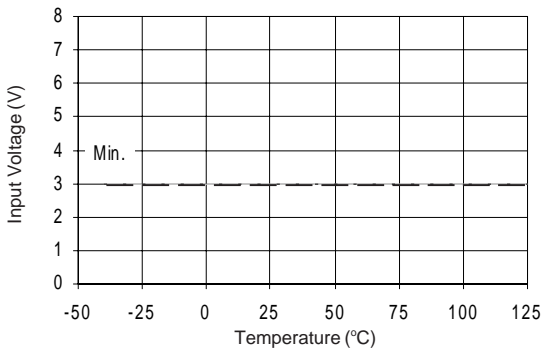

Figure 12A. Logic "1" (HO) & Logic "0" (LO) Input Voltage vs Temperature

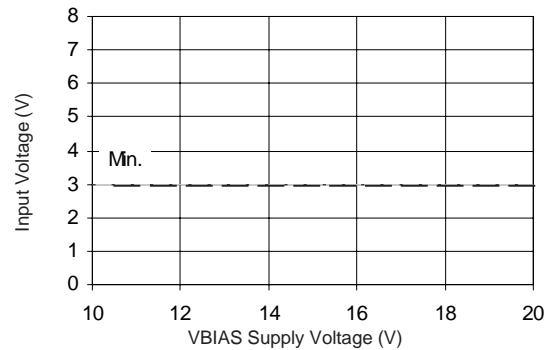

Figure 12B. Logic "1" (HO) & Logic "0" (LO) Input Voltage vs Voltage

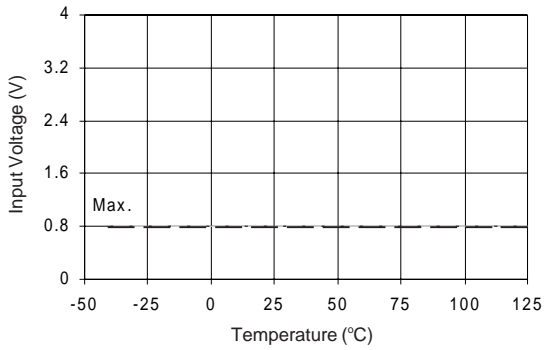

Figure 13A. Logic "0"(HO) & Logic "1"(LO) Input Voltage vs Temperature

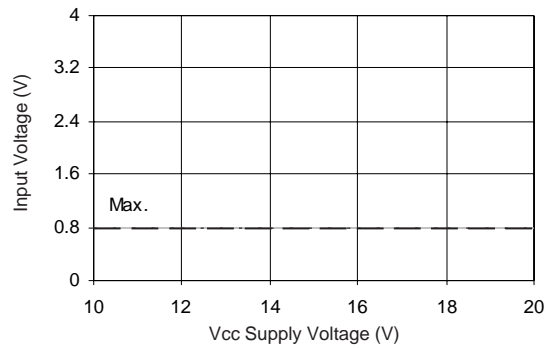

Figure 13B. Logic "0"(HO) & Logic "1"(LO) Input Voltage vs Voltage

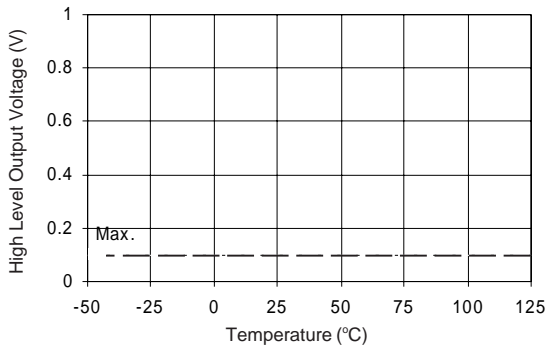

Figure 14A. High Level Output vs Temperature

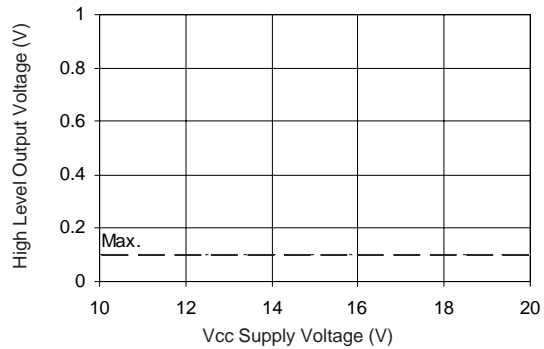

Figure 14B. High Level Output vs Voltage

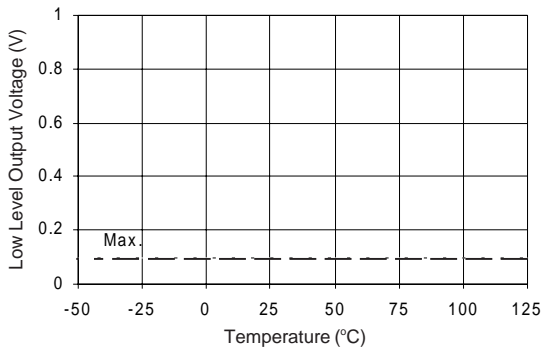

Figure 15A. Low Level Output vs Temperature

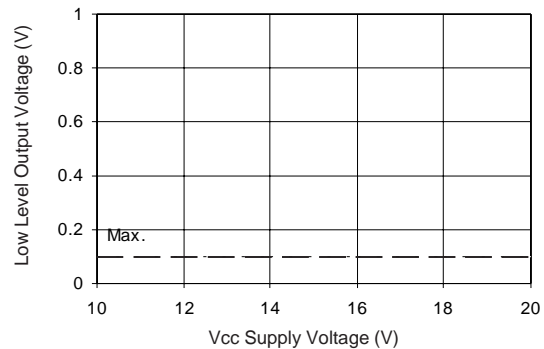

Figure 15B. Low Level Output vs Voltage

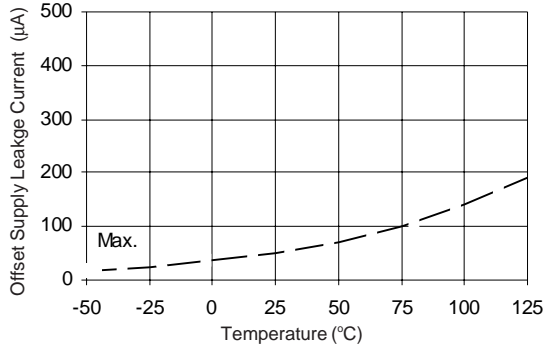

Figure 16A. Offset Supply Current vs Temperature

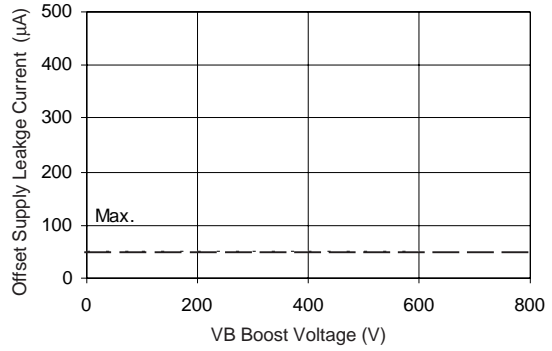

Figure 16B. Offset Supply Current vs Voltage

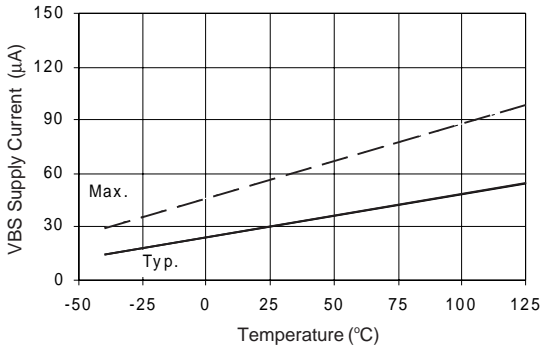

Figure 17A. VBS Supply Current vs Temperature

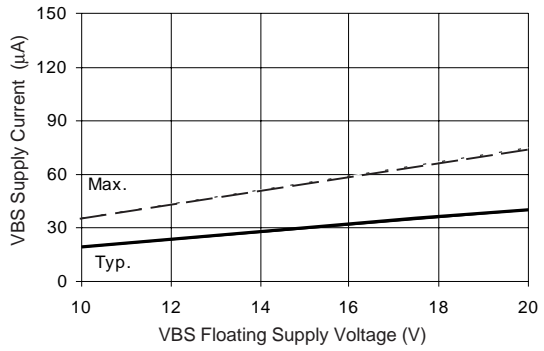

Figure 17B. VBS Supply Current vs Voltage

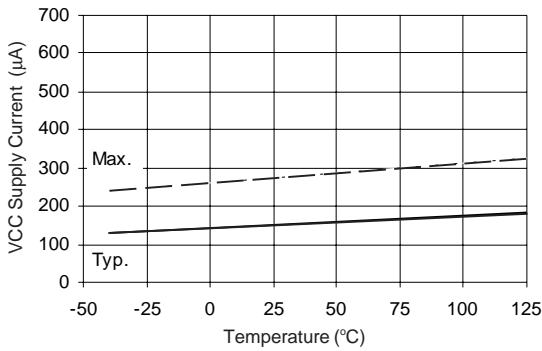

Figure 18A. VCC Supply Current vs Temperature

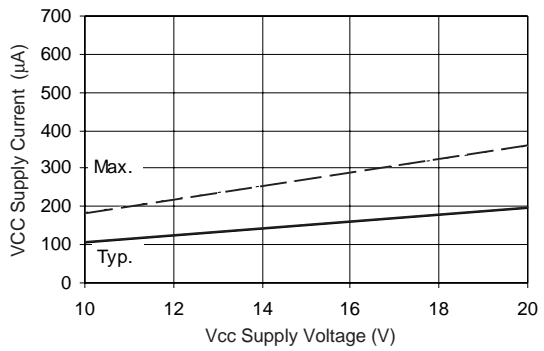

Figure 18B. VCC Supply Current vs Voltage

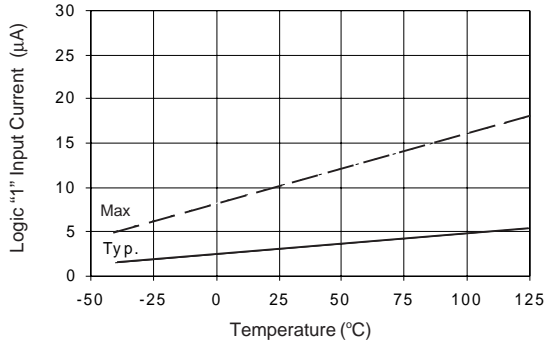

Figure 19A. Logic "1" Input Current vs Temperature

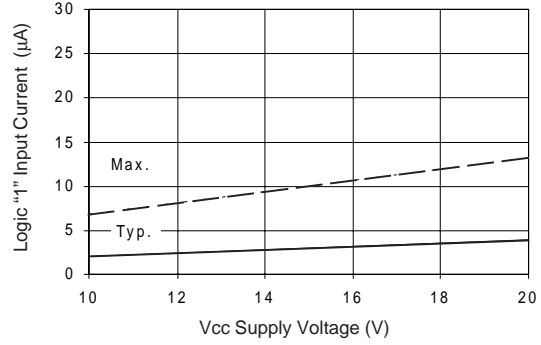

Figure 19B. Logic "1" Input Current vs Voltage

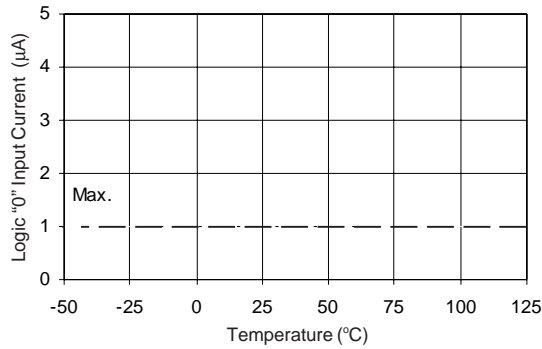

Figure 20A. Logic "0" Input Current vs Temperature

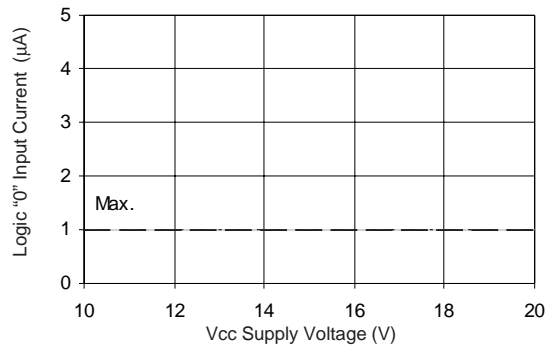

Figure 20B. Logic "0" Input Current vs Voltage

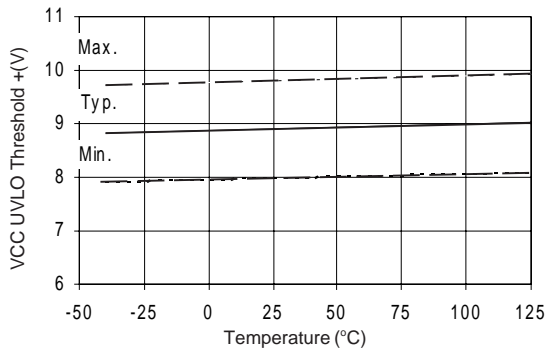

Figure 21A. Vcc Undervoltage Threshold (+) vs Temperature

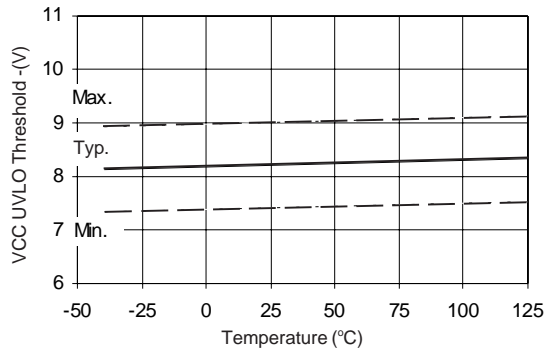

Figure 21B. Vcc Undervoltage Threshold (-) vs Temperature

IR2105

International
IR Rectifier

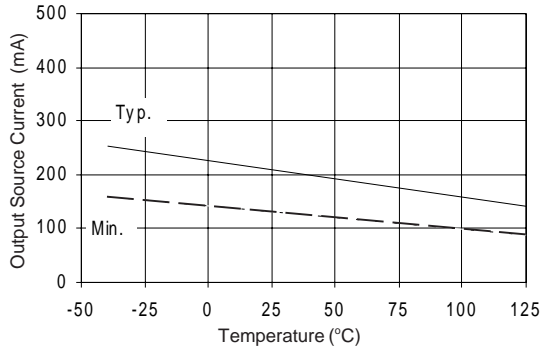

Figure 22A. Output Source Current vs Temperature

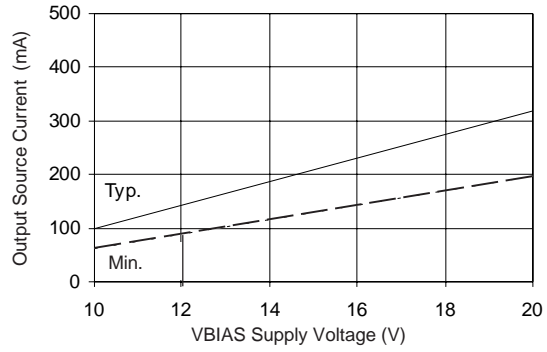

Figure 22B. Output Source Current vs Voltage

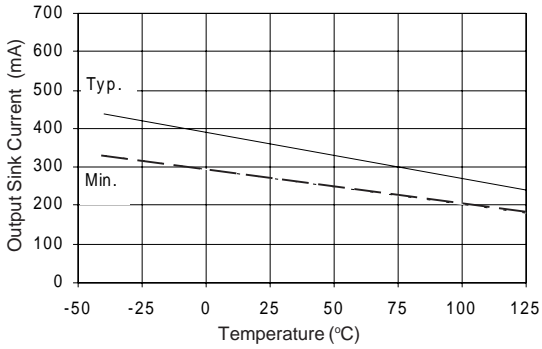

Figure 23A. Output Sink Current vs Temperature

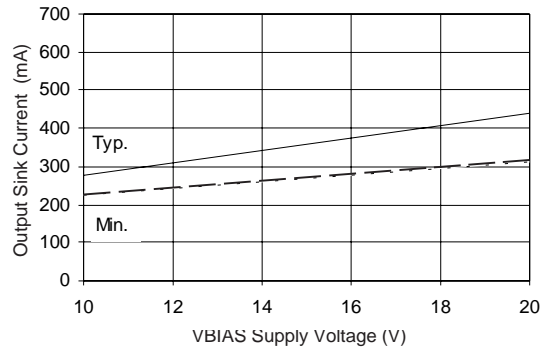

Figure 23B. Output Sink Current vs Voltage

International
IR Rectifier

WORLD HEADQUARTERS: 233 Kansas St., El Segundo, California 90245 Tel: (310) 322 3331

IR GREAT BRITAIN: Hurst Green, Oxted, Surrey RH8 9BB, UK Tel: ++ 44 1883 732020

IR JAPAN: K&H Bldg., 2F, 30-4 Nishi-Ikebukuro 3-Chome, Toshima-Ku, Tokyo, Japan 171-0021 Tel: 8133 983 0086

IR HONG KONG: Unit 308, #F, New East Ocean Centre, No. 9 Science Museum Road, Tsimshatsui East, Kowloon, Hong Kong Tel: (852) 2803-7380

Data and specifications subject to change without notice. 11/29/99

www.irf.com

Looking for pricing, stock, or lifecycle information?

Click below to explore more details on WIN SOURCE:

 [View IR2105STR](#) on WIN SOURCE

 [Infineon Technologies](#) Information

Optimize Your Supply Chain with WIN SOURCE Solutions

-  Global Sourcing Solution
-  Obsolete Management
-  Cost Control Management
-  Shortage Management
-  Alternative Solution
-  Excess Inventory Management