

High Speed Two-Channel Digital Isolators

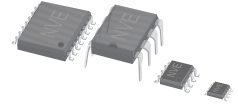

Functional Diagrams

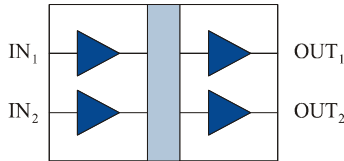

IL711

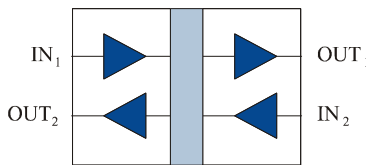

IL712

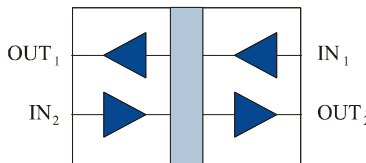

IL721

Features

- High speed: 150 Mbps typical (S-Series)
- High temperature: -40°C to $+125^{\circ}\text{C}$ (T-Series and V-Series)
- 6 kV_{RMS} Reinforced Isolation; 1.2 kV_{RMS} Working Voltage (V-Series)
- 2.7 to 5.5 volt supply range
- 100 kV/ μs Common Mode Transient Immunity
- No carrier or clock for low EMI emissions and susceptibility
- 1.2 mA/channel typical quiescent current
- 300 ps typical pulse width distortion (S-Series)
- 100 ps pulse jitter
- 2 ns channel-to-channel skew
- 10 ns typical propagation delay
- 44000 year barrier life
- Excellent magnetic immunity
- IEC 60747-17 (VDE 0884-17):2021-10 certified; UL 1577 recognized
- 6 kV_{RMS} Reinforced Isolation; 1.2 kV_{RMS} Working Voltage (V-Series)
- ATEX / IECEx certified for IS-to-IS intrinsically safe applications
- MSOP, SOIC, PDIP, and True 8 mm creepage packages

Applications

- Board-to-board communication
- CANbus
- Peripheral interfaces
- Logic level shifting
- Equipment covered under IEC 61010-1 Edition 3
- 5 kV_{RMS} rated IEC 60601-1 medical applications

Description

NVE's IL700 family of high-speed digital isolators are CMOS devices manufactured with NVE's patented* spintronic Giant Magnetoresistive (GMR) technology. A unique ceramic/polymer composite barrier provides excellent isolation and virtually unlimited barrier life.

The IL711S and IL712S are the world's fastest two-channel isolators, with a 150 Mbps typical data rate for both channels. Standard and S-Grade parts are specified over a temperature range of -40°C to $+100^{\circ}\text{C}$; "T" and "V" Grade parts have a maximum operating temperature of 125°C . V-Grade versions offer extremely high isolation voltages of 6 kV_{RMS} for wide-body packages and 2.5 kV_{RMS} for MSOPs.

The symmetric magnetic coupling barrier provides a typical propagation delay of only 10 ns and a pulse width distortion as low as 300 ps (0.3 ns), achieving the best specifications of any isolator. Minimum transient immunity of 100 kV/ μs is unsurpassed.

The IL711 has two transmit channels; the IL712 and IL721 have one transmit and one receive channel. The IL721 has channels reversed to better suit certain board layouts.

The IL711 and IL712 are available in 8-pin MSOP, SOIC, and PDIP packages. The IL711 and IL721 are also available in NVE's unique JEDEC-compliant 16 pin package with True 8 mm creepage under IEC 60601.

Absolute Maximum Ratings

Parameters	Symbol	Min.	Typ.	Max.	Units	Test Conditions
Storage Temperature	T_S	-55		150	°C	
Junction Temperature	T_J	-55		150	°C	
Ambient Operating Temperature ⁽¹⁾	T_A	-55		130	°C	
Supply Voltage	V_{DD1}, V_{DD2}	-0.5		7	V	
Input Voltage	V_I	-0.5		$V_{DD} + 0.5$	V	
Output Voltage	V_O	-0.5		$V_{DD} + 0.5$	V	
Output Current Drive	I_O			10	mA	
Lead Solder Temperature				260	°C	10 sec.
ESD			2		kV	HBM

Recommended Operating Conditions

Parameters	Symbol	Min.	Typ.	Max.	Units	Test Conditions
Ambient Operating Temperature IL711/IL712/IL721/IL711S/IL712S IL711T/IL711VE/IL712T/IL721T/IL721VE	T_A	-40		100 125	°C °C	
Junction Temperature IL711/IL712/IL721/IL711S/IL712S IL711T/IL711VE/IL712T/IL721T/IL721VE	T_J	-40		110 125	°C °C	
Supply Voltage	V_{DD1}, V_{DD2}	2.7		5.5	V	
Logic High Input Voltage	V_{IH}	2.4		V_{DD}	V	
Logic Low Input Voltage	V_{IL}	0		0.8	V	
Input Signal Rise and Fall Times	t_{R}, t_{F}			1	μs	

Safety and Approvals

IEC 60747-17 (VDE 0884-17):2021-10:

“VE” versions (Reinforced Isolation; VDE File Number 5016933-4880-0002)

- Working Voltage (V_{IORM}): 1200 V_{RMS} (1700 V_{PK}) with 20% Safety Factor; pollution degree 2
- Isolation voltage (V_{ISO}): 6000 V_{RMS}
- Surge immunity (V_{IOSM}): 12.8 kV_{PK}
- Surge rating: 8000 V
- Transient overvoltage (V_{IOTM}): 6000 V_{PK}
- Each part tested at 2387 V_{PK} for 1 second, 5 pC partial discharge limit
- Samples tested at 6000 V_{PK} for 60 sec.; then 2122 V_{PK} for 10 sec. with 5 pC partial discharge limit

Standard versions (Basic Isolation; VDE File Number 5016933-4880-0001)

- Isolation voltage (V_{ISO}): 2500 V_{RMS}
- Transient overvoltage (V_{IOTM}): 4000 V_{PK}
- Surge rating: 4000 V
- Each part tested at 1590 V_{PK} for 1 second, 5 pC partial discharge limit.
- Samples tested at 4000 V_{PK} for 60 sec.; then 1358 V_{PK} for 10 sec. with 5 pC partial discharge limit.
- Working Voltage (V_{IORM} ; pollution degree 2):

Package	Part No. Suffix	Working Voltage
MSOP8	-1	800 V_{RMS}
Narrow-body SOIC16	-3	700 V_{RMS}
Wide-body SOIC16/True 8™	None	600 V_{RMS}
PDIP8	-2	900 V_{RMS}

Safety-Limiting Values	Symbol	Value	Units
Safety rating ambient temperature	T_S	180	°C
Safety rating power (180 °C)	P_S	270	mW
Supply current safety rating (total of supplies)	I_S	54	mA

UL 1577 (Component Recognition Program File Number E207481)

- 1 kV-rated standard MSOPs tested at 1200 V_{RMS} (1768 V_{PK}) for 1 second; each lot sample tested at 1200 V_{RMS} (1768 V_{PK}) for 1 minute
- 2.5 kV-rated parts tested at 3000 V_{RMS} (4240 V_{PK}) for 1 second; each lot sample tested at 2500 V_{RMS} (3530 V_{PK}) for 1 minute
- 6 kV-rated VE-version parts tested at 7.2 kV_{RMS} (10.2 kV_{PK}) for 1 second; each lot sample tested at 6 kV_{RMS} (8485 V_{PK}) for 1 minute

Intrinsically Safe Certification

- “VE” versions are ATEX / IEC 60079-0 / 60079-11 certified Intrinsically Safe (IS) for use in IS to IS applications.
- 500 V_{RMS} rating.

Soldering Profile

Per JEDEC J-STD-020C, MSL 1

IL711-1, -2, and -3 Pin Connections

1	V _{DD1}	Supply voltage
2	IN ₁	Data in, channel 1
3	IN ₂	Data in, channel 2
4	GND ₁	Ground return for V _{DD1}
5	GND ₂	Ground return for V _{DD2}
6	OUT ₂	Data out, channel 2
7	OUT ₁	Data out, channel 1
8	V _{DD2}	Supply voltage

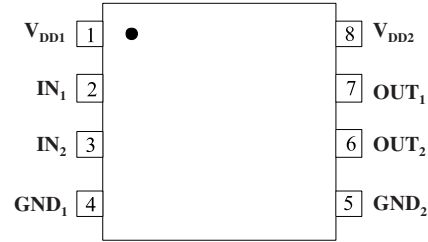

IL711-1, -2, and -3

IL711 Pin Connections

1	GND ₁	Ground return for V _{DD1}
2	GND ₁	(pins 1, 2, 7, and 8 internally connected)
3	V _{DD1}	Supply voltage
4	IN ₁	Data in, channel 1
5	IN ₂	Data in, channel 2
6	NC	No connection
7	GND ₁	Ground return for V _{DD1}
8	GND ₁	(pins 1, 2, 7, and 8 internally connected)
9	GND ₂	Ground return for V _{DD2}
10	GND ₂	(pins 9, 10, 15, and 16 internally connected)
11	NC	No connection
12	OUT ₂	Data out, channel 2
13	OUT ₁	Data out, channel 1
14	V _{DD2}	Supply voltage
15	GND ₂	Ground return for V _{DD2}
16	GND ₂	(pins 9, 10, 15, and 16 internally connected)

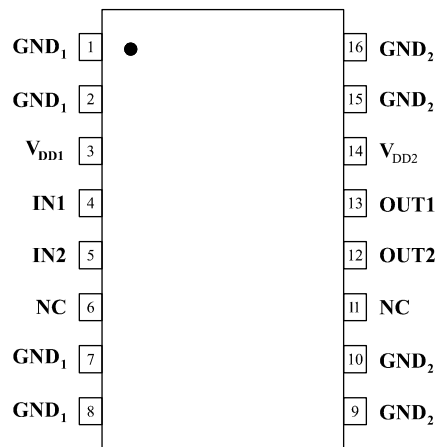

IL711

IL712-1, -2, and -3 Pin Connections

1	V _{DD1}	Supply voltage
2	IN ₁	Data in, channel 1
3	OUT ₂	Data out, channel 2
4	GND ₁	Ground return for V _{DD1}
5	GND ₂	Ground return for V _{DD2}
6	IN ₂	Data in, channel 2
7	OUT ₁	Data out, channel 1
8	V _{DD2}	Supply voltage

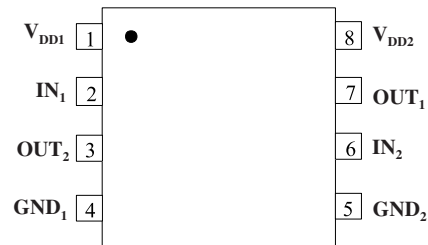

IL712-1, -2, and -3

IL721-3 Pin Connections

1	V _{DD1}	Supply voltage
2	OUT ₁	Data out, channel 1
3	IN ₂	Data in, channel 2
4	GND ₁	Ground return for V _{DD1}
5	GND ₂	Ground return for V _{DD2}
6	OUT ₂	Data out, channel 2
7	IN ₁	Data in, channel 1
8	V _{DD2}	Supply voltage

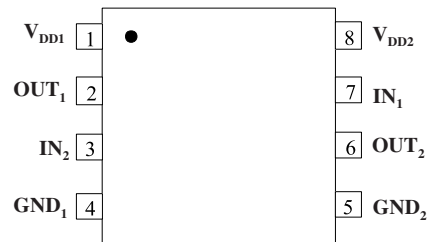

IL721-3

IL721 Pin Connections

1		
2	GND ₁	Ground return for V _{DD1} (pins 1, 2, 7, and 8 internally connected)
3	V _{DD1}	Supply voltage
4	OUT ₁	Data out, channel 1
5	IN ₂	Data in, channel 2
6	NC	No connection
7	GND ₁	Ground return for V _{DD1} (pins 1, 2, 7, and 8 internally connected)
8	GND ₁	Ground return for V _{DD1} (pins 1, 2, 7, and 8 internally connected)
9	GND ₂	Ground return for V _{DD2} (pins 9, 10, 15, and 16 internally connected)
10	GND ₂	Ground return for V _{DD2} (pins 9, 10, 15, and 16 internally connected)
11	NC	No connection
12	OUT ₂	Data out, channel 2
13	IN ₁	Data in, channel 1
14	V _{DD2}	Supply voltage
15	GND ₂	Ground return for V _{DD2} (pins 9, 10, 15, and 16 internally connected)
16	GND ₂	Ground return for V _{DD2} (pins 9, 10, 15, and 16 internally connected)

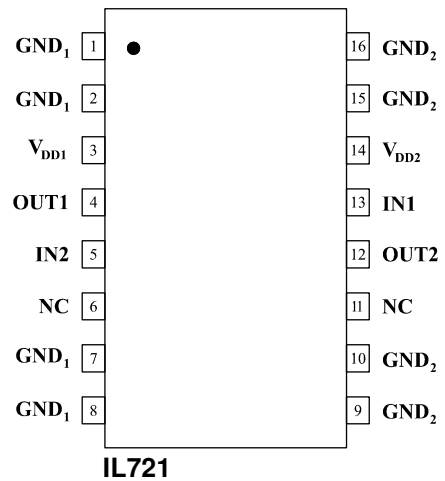

3.3 Volt Electrical Specifications (T _{min} to T _{max} unless otherwise stated)						
Parameters	Symbol	Min.	Typ.	Max.	Units	Test Conditions
Input Quiescent Supply Current						
IL711	I _{DD1}		8	10	μA	
IL712/IL721			1.2	1.75	mA	
Output Quiescent Supply Current						
IL711	I _{DD2}		2.4	3.5	mA	
IL712/IL721			1.2	1.75	mA	
Logic Input Current	I _I	-10		10	μA	
Logic High Output Voltage	V _{OH}	V _{DD} - 0.1	V _{DD}		V	I _O = -20 μA, V _I = V _{IH}
		0.8 x V _{DD}	0.9 x V _{DD}			I _O = -4 mA, V _I = V _{IH}
Logic Low Output Voltage	V _{OL}		0	0.1	V	I _O = 20 μA, V _I = V _{IL}
			0.5	0.8		I _O = 4 mA, V _I = V _{IL}

Switching Specifications (V _{DD} = 3.3 V)						
Maximum Data Rate					Mbps	C _L = 15 pF
IL711/IL712/IL721		100	110			
IL711S/IL712S		130	140		Mbps	C _L = 15 pF
IL711T/IL712T/IL721T		100	110		Mbps	C _L = 15 pF
Pulse Width ⁽⁷⁾	PW	10	7.5		ns	50% Points, V _O
Propagation Delay Input to Output (High to Low)	t _{PHL}		12	18	ns	C _L = 15 pF
Propagation Delay Input to Output (Low to High)	t _{PLH}		12	18	ns	C _L = 15 pF
Pulse Width Distortion ⁽²⁾						
IL711/IL712/IL721	PWD		2	3	ns	C _L = 15 pF
IL711S/IL712S			2	3	ns	C _L = 15 pF
IL711T/IL712T/IL721T			1	3	ns	C _L = 15 pF
Propagation Delay Skew ⁽³⁾	t _{PSK}		4	6	ns	C _L = 15 pF
Output Rise Time (10%–90%)	t _R		2	4	ns	C _L = 15 pF
Output Fall Time (10%–90%)	t _F		2	4	ns	C _L = 15 pF
Common Mode Transient Immunity (Output Logic High or Logic Low) ⁽⁴⁾	ICM _H , ICM _L	100	150		kV/μs	Per IEC 60747
Channel-to-Channel Skew	t _{CSK}		2	3	ns	C _L = 15 pF
Dynamic Power Consumption ⁽⁶⁾						
Input side			140	240	μA/Mbps/ch	
Output side			20	40		

Magnetic Field Immunity ⁽⁸⁾ (V _{DD2} = 3.3 V, 2.7 V < V _{DD1} < 5.5 V)						
Power Frequency Magnetic Immunity	H _{PF}		1500		A/m	50Hz/60Hz
Pulse Magnetic Field Immunity	H _{PM}		2000		A/m	t _p = 8 μs
Damped Oscillatory Magnetic Field	H _{OSC}		2000		A/m	0.1Hz – 1MHz
Cross-axis Immunity Multiplier ⁽⁹⁾	K _X		2.5			

Timing Diagram

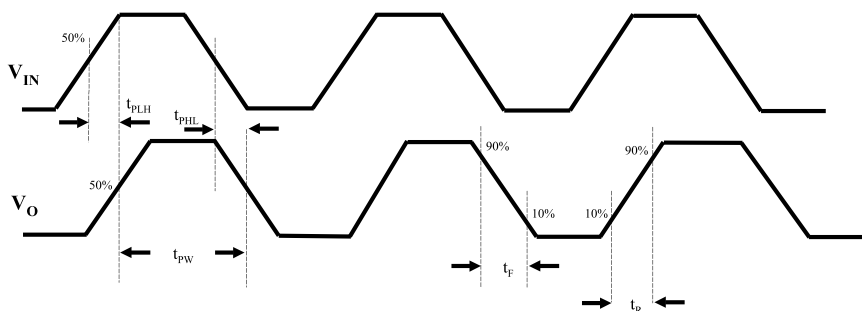

Legend

t _{PLH}	Propagation Delay, Low to High
t _{PHL}	Propagation Delay, High to Low
t _{PW}	Minimum Pulse Width
t _R	Rise Time
t _F	Fall Time

5 Volt Electrical Specifications (T _{min} to T _{max} unless otherwise stated)						
Parameters	Symbol	Min.	Typ.	Max.	Units	Test Conditions
Input Quiescent Supply Current						
IL711	I _{DD1}		10	15	μA	
IL712/IL721			1.8	2.5	mA	
Output Quiescent Supply Current						
IL711	I _{DD2}		3.6	5	mA	
IL712/IL721				1.8	2.5	mA
Logic Input Current	I _I	-10		10	μA	
Logic High Output Voltage	V _{OH}	V _{DD} - 0.1	V _{DD}		V	I _O = -20 μA, V _I = V _{IH}
		0.8 x V _{DD}	0.9 x V _{DD}			I _O = -4 mA, V _I = V _{IH}
Logic Low Output Voltage	V _{OL}		0	0.1	V	I _O = 20 μA, V _I = V _{IL}
				0.5		0.8

Switching Specifications (V _{DD} = 5 V)						
Maximum Data Rate						
IL711/IL712/IL721		100	110		Mbps	C _L = 15 pF
IL711S/IL712S		130	150		Mbps	C _L = 15 pF
IL711T/IL712T/IL721T		100	110		Mbps	C _L = 15 pF
Pulse Width ⁽⁷⁾	PW	10	7.5		ns	50% Points, V _O
Propagation Delay Input to Output (High to Low)	t _{PHL}		10	15	ns	C _L = 15 pF
Propagation Delay Input to Output (Low to High)	t _{PLH}		10	15	ns	C _L = 15 pF
Pulse Width Distortion ⁽²⁾	PWD		2	3	ns	C _L = 15 pF
IL711/IL712/IL721			2	3	ns	C _L = 15 pF
IL711S/IL712S			0.3	3	ns	C _L = 15 pF
IL711T/IL712T/IL721T						
Pulse Jitter ⁽¹⁰⁾	t _J		100		ps	C _L = 15 pF
Propagation Delay Skew ⁽³⁾	t _{PSK}		4	6	ns	C _L = 15 pF
Output Rise Time (10%–90%)	t _R		1	3	ns	C _L = 15 pF
Output Fall Time (10%–90%)	t _F		1	3	ns	C _L = 15 pF
Common Mode Transient Immunity (Output Logic High or Logic Low) ⁽⁴⁾	CM _H , CM _L	100	150		kV/μs	Per IEC 60747
Channel to Channel Skew	t _{CSK}		2	3	ns	C _L = 15 pF
Dynamic Power Consumption ⁽⁶⁾			200	340	μA/Mbps	per channel

Magnetic Field Immunity ⁽⁸⁾ (V _{DD2} = 5 V, 2.7 V < V _{DD1} < 5.5 V)						
Power Frequency Magnetic Immunity	H _{PF}		3500		A/m	50Hz/60Hz
Pulse Magnetic Field Immunity	H _{PM}		4500		A/m	t _p = 8 μs
Damped Oscillatory Magnetic Field	H _{OSC}		4500		A/m	0.1Hz – 1MHz
Cross-axis Immunity Multiplier ⁽⁹⁾	K _X		2.5			

Insulation Specifications						
Parameter	Symbol	Min.	Typ.	Max.	Units	Test Conditions
Creepage Distance (external)						
MSOP8		3.01			mm	
SOIC8		4.03			mm	
PDIP8		6.8			mm	
True 8™ 0.3" SOIC16		8.03	8.3		mm	Per IEC 60601
Total Barrier Thickness (internal)						
		0.012	0.016		mm	
Leakage Current ⁽⁵⁾						
			0.2		μA	240 V _{RMS} , 60 Hz
Barrier Resistance ⁽⁵⁾						
	R _{IO}		>10 ¹⁴		Ω	500 V
Barrier Capacitance ⁽⁵⁾						
	C _{IO}		2		pF	f = 1 MHz
Comparative Tracking Index						
	CTI	≥600			V _{RMS}	Per IEC 60112
High Voltage Endurance (Maximum Barrier Voltage for Indefinite Life)						
	AC	1000			V _{RMS}	At maximum operating temperature
	DC	1500			V _{DC}	
Surge Immunity ("VE" Versions)						
	V _{IOSM}	12.8			kV _{PK}	Per IEC 61000-4-5
Barrier Life						
			44000		Years	100°C, 1000 V _{RMS} , 60% CL activation energy

Thermal Characteristics						
Parameter	Symbol	Min.	Typ.	Max.	Units	Test Conditions
Junction–Ambient Thermal Resistance	MSOP8 0.15" SOIC8 0.3" SOIC16 PDIP8	θ _{JA}	184			Double-sided PCB in free air
			134			
			67			
			114			
Junction–Case (Top) Thermal Resistance	MSOP8 0.15" SOIC8 0.3" SOIC16 PDIP8	θ _{JC}	15		°C/W	2s2p PCB in free air per JESD51
			10			
			12			
			36			
Junction–Ambient Thermal Resistance	0.3" SOIC	θ _{JA}	46			
Junction–Case (Top) Thermal Resistance		θ _{JC}	9			
Power Dissipation	MSOP8 0.15" SOIC8 0.3" SOIC16 PDIP8	P _D		500	mW	
				675		
				1500		
				800		

Notes (apply to both 3.3 V and 5 V specifications):

1. Absolute maximum ambient operating temperature means the device will not be damaged if operated under these conditions. It does not guarantee performance.
2. PWD is defined as $t_{PHL} - t_{PLH}$. %PWD is equal to PWD divided by pulse width.
3. t_{PSK} is the magnitude of the worst-case difference in t_{PHL} and/or t_{PLH} between devices at 25°C.
4. CM_H and CM_L are the maximum common mode voltage slew rates that can be applied with the outputs remaining stable and within V_{OL} and V_{OH} specifications.
5. Device is considered a two terminal device: pins 1–4 shorted and pins 5–8 shorted.
6. Dynamic power consumption is calculated per channel and is supplied by the channel's input side power supply.
7. Minimum pulse width is the minimum value at which specified PWD is guaranteed.
8. The relevant test and measurement methods are given in the Electromagnetic Compatibility section on p. 9.
9. External magnetic field immunity is improved by this factor if the field direction is "end-to-end" rather than to "pin-to-pin" (see diagram on p. 9).
10. 64k-bit pseudo-random binary signal (PRBS) NRZ bit pattern with no more than five consecutive 1s or 0s; 800 ps transition time.

Typical Performance Graphs

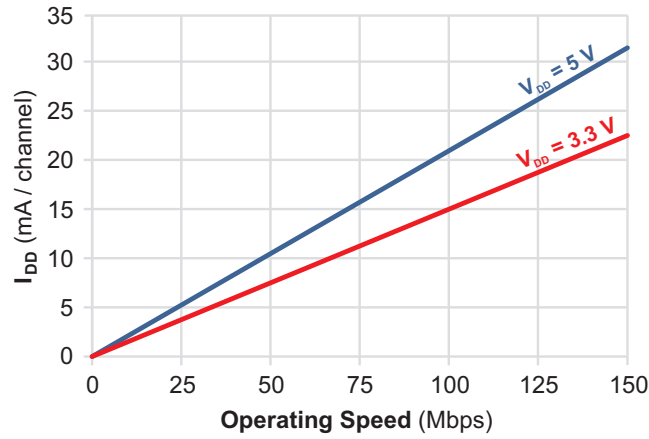

Figure 1. Supply current (per channel) vs. operating speed.

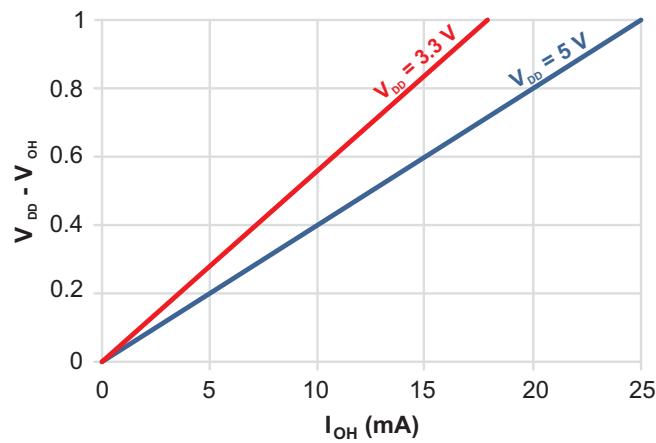

Figure 2. Typical high output voltage vs. load.

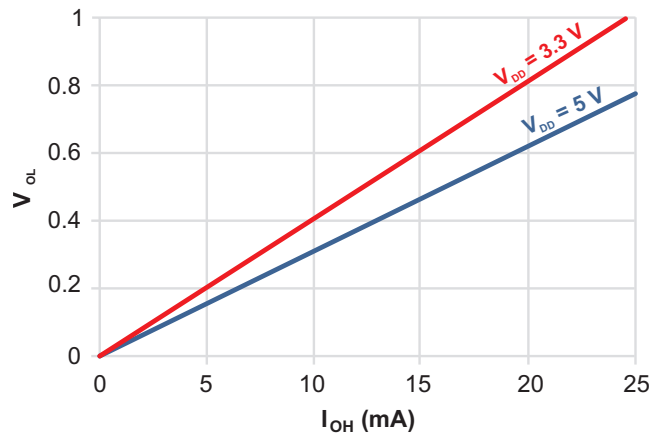

Figure 3. Typical low output voltage vs. load

Application Information

Isolator Operation

An equivalent circuit is shown below:

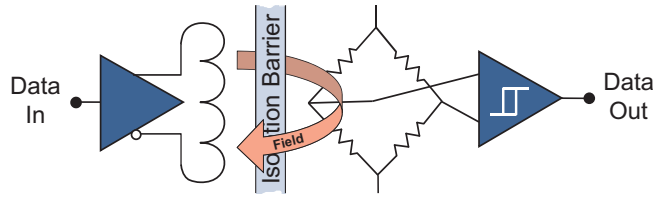

Figure 4. IL711 / IL712 / IL721 equivalent circuit (each channel).

Isolator Signal Path

The GMR isolator signal path starts with a buffered input signal that is driven through an ultraminiature coil. This generates a small magnetic field that changes the electron spin polarization of GMR resistors, which are configured as a Wheatstone bridge. The change in spin polarization of the resistors creates a bridge voltage which drives an output comparator to construct an isolated version of the input signal.

Small Size, High Speed, and Low EMI

The coil, GMR, and circuitry are integrated to allow small packages. GMR is inherently high speed and low distortion, and unlike transformers, does not rely on energy transfer, so power is low and EMI emissions are minimal.

High Magnetic Immunity

GMR provides large signals which improve magnetic immunity, and the Wheatstone bridge configuration cancels ambient common-mode magnetic fields, further enhancing immunity to external magnetic fields.

Electrostatic Discharge Sensitivity

This product has been tested for electrostatic sensitivity to the limits stated in the specifications. However, NVE recommends that all integrated circuits be handled with appropriate care to avoid damage. Damage caused by inappropriate handling or storage could range from performance degradation to complete failure.

Electromagnetic Compatibility

IsoLoop Isolators have the lowest EMC footprint of any isolation technology. IsoLoop Isolators' Wheatstone bridge configuration and differential magnetic field signaling ensure excellent EMC performance against all relevant standards.

These isolators are fully compliant with IEC 61000-6-1 and IEC 61000-6-2 standards for immunity, and IEC 61000-6-3, IEC 61000-6-4, CISPR, and FCC Class A standards for emissions.

Immunity to external magnetic fields is even higher if the field direction is "end-to-end" rather than to "pin-to-pin" as shown in the diagram below:

Cross-axis Field Direction

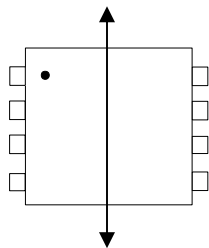

Dynamic Power Consumption

IsoLoop Isolators achieve their low power consumption from the way they transmit data across the isolation barrier. By detecting the edge transitions of the input logic signal and converting these to narrow current pulses, a magnetic field is created around the GMR Wheatstone bridge. Depending on the direction of the magnetic field, the bridge causes the output comparator to switch following the input logic signal. Since the current pulses are narrow, about 2.5 ns, the power consumption is independent of mark-to-space ratio and solely dependent on frequency. This has obvious advantages over optocouplers, which have power consumption heavily dependent on mark-to-space ratio.

Power Supply Decoupling

Both power supplies should be decoupled with 0.1 μF typical (0.047 μF minimum) capacitors as close as possible to the V_{DD} pins. Ground planes for both GND_1 and GND_2 are highly recommended for data rates above 10 Mbps.

Maintaining Creepage

Creepage distances are often critical in isolated circuits. In addition to meeting JEDEC standards, NVE isolator packages have unique creepage specifications. Standard pad libraries often extend under the package, compromising creepage and clearance. Similarly, ground planes, if used, should be spaced to avoid compromising clearance. Package drawings and recommended pad layouts are included in this datasheet.

Signal Status on Start-up and Shut Down

To minimize power dissipation, input signals are differentiated and then latched on the output side of the isolation barrier to reconstruct the signal. This could result in an ambiguous output state depending on power up, shutdown and power loss sequencing. Unless the circuit connected to the isolator performs its own power- on reset (POR), a start-up initialization circuit should be considered. Initialization consists of toggling the input either high then low, or low then high.

In CAN applications, the IL712 or IL721 should be used with CAN transceivers with Dominant Timeout functions for seamless POR. Most CAN transceivers have Dominant Timeout options. Examples include NXP's TJA 1050 and TJA 1040 transceivers.

Data Transmission Rates

The reliability of a transmission system is directly related to the accuracy and quality of the transmitted digital information. For a digital system, those parameters which determine the limits of the data transmission are pulse width distortion and propagation delay skew.

Propagation delay is the time taken for the signal to travel through the device. This is usually different when sending a low-to-high than when sending a high-to-low signal. This difference, or error, is called pulse width distortion (PWD) and is usually in nanoseconds. It may also be expressed as a percentage:

$$\text{PWD}\% = \frac{\text{Maximum Pulse Width Distortion (ns)}}{\text{Signal Pulse Width (ns)}} \times 100\%$$

For example, with data rates of 12.5 Mbps:

$$\text{PWD}\% = \frac{3 \text{ ns}}{80 \text{ ns}} \times 100\% = 3.75\%$$

This figure is almost **three times** better than any available optocoupler with the same temperature range, and **two times** better than any optocoupler regardless of published temperature range. IsoLoop isolators exceed the 10% maximum PWD recommended by PROFIBUS, and will run to nearly 35 Mb within the 10% limit.

Propagation delay skew is the signal propagation difference between two or more channels. This becomes significant in clocked systems because it is undesirable for the clock pulse to arrive before the data has settled. Propagation delay skew is especially critical in high data rate parallel systems for establishing and maintaining accuracy and repeatability. Worst-case channel-to-channel skew in an IL700 Isolator is just 3 ns—**ten times** better than any optocoupler. IL700 Isolators have a maximum propagation delay skew of 6 ns—**five times** better than any optocoupler.

Illustrative Applications

NVE offers a unique line of single-chip isolated RS-485, PROFIBUS, and CAN transceivers, but as illustrated in the circuits below, IL700-Series Isolators can also be used as part of multi-chip designs with non-isolated transceivers:

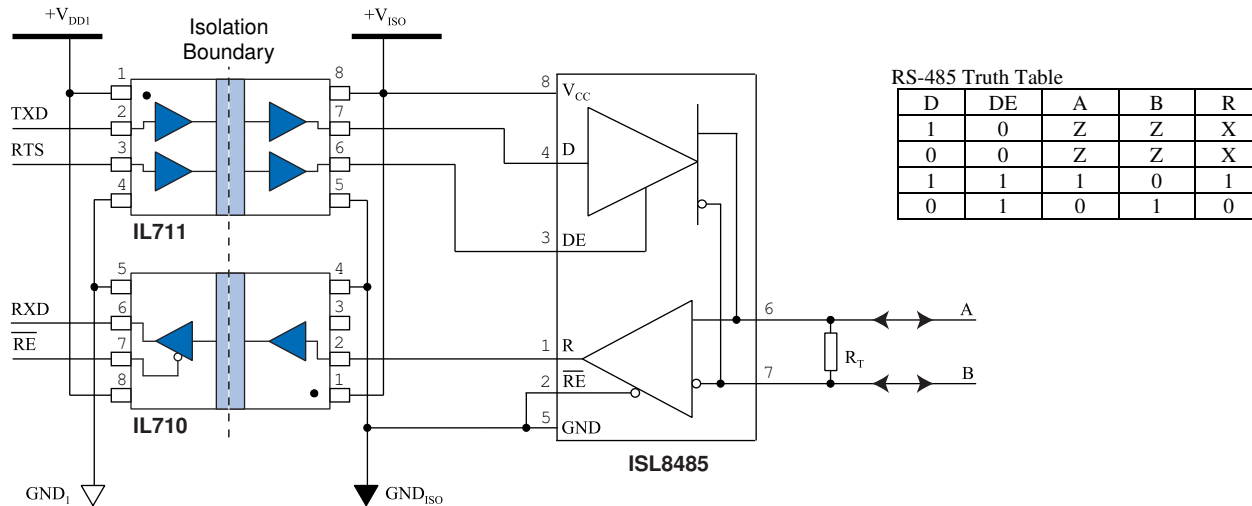

Figure 1. Isolated PROFIBUS / RS-485 circuit.

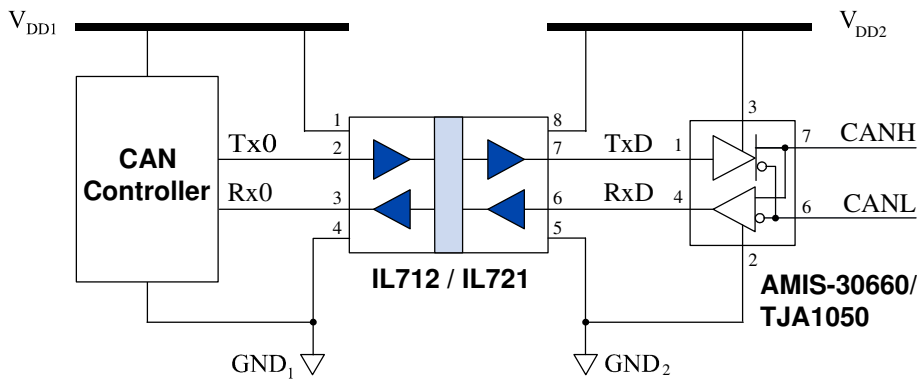

Figure 2. Isolated CAN circuit.

CAN isolation is increasingly necessary to reduce EMI susceptibility, especially in high-speed applications and in hybrid and electrical vehicle networks, where the 12 V battery has been replaced with one of several hundred volts. Operator and equipment safety becomes critical when a high voltage source, such as the battery, needs to be connected to diagnosis systems during routine maintenance procedures. In the application shown above, the microcontroller is isolated from the CAN transceiver by an IL712 or IL721, allowing higher speed and more reliable bus operation by eliminating ground loops and reducing susceptibility to noise and EMI events. The best-in-class 10 ns typical IL712/IL721 propagation delay minimizes CAN loop delay and maximizes data rate over any given bus length. This simple circuit works with any CAN transceiver with a TxD dominant timeout, which includes all of the current-generation transceivers.

Package Drawings

8-pin MSOP (-1 suffix)

Dimensions in inches (mm); scale = approx. 5X

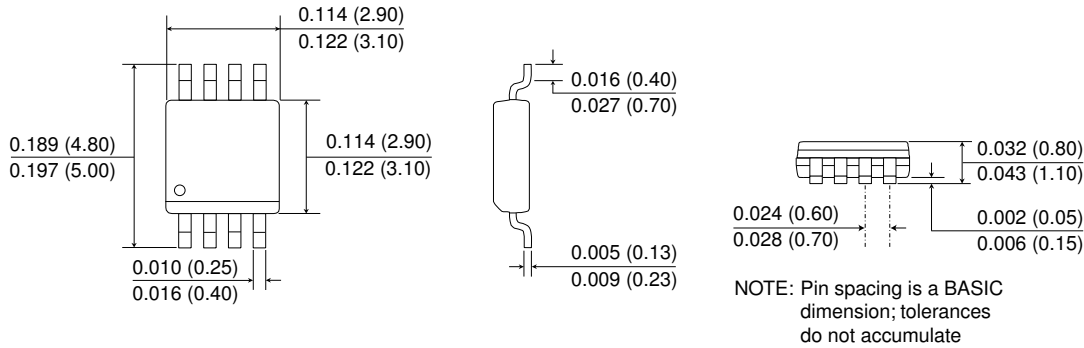

8-pin SOIC Package (-3 suffix)

Dimensions in inches (mm); scale = approx. 5X

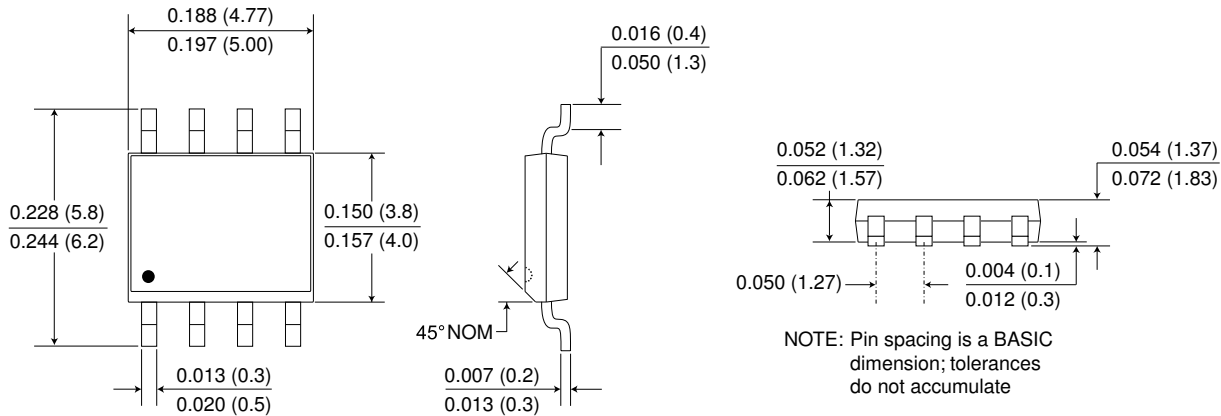

8-pin PDIP (-2 suffix)

Dimensions in inches (mm); scale = approx. 2.5X

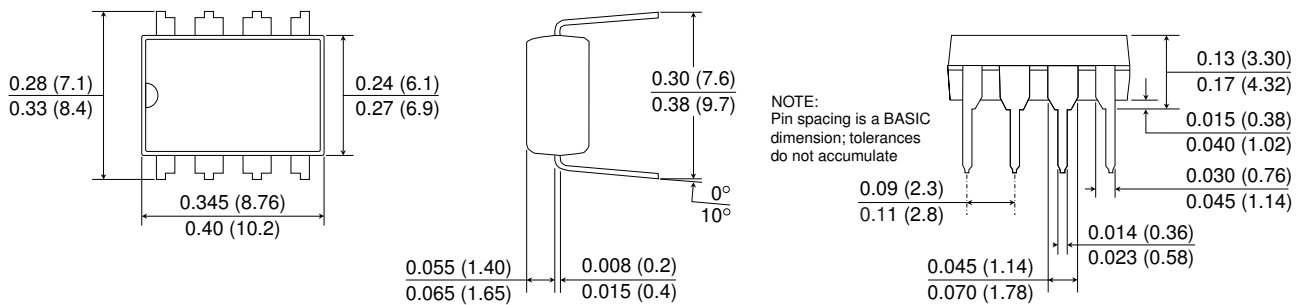

True 8™ (8 mm creepage) 16-pin SOIC Package (no suffix)

Dimensions in inches (mm); scale = approx. 5X

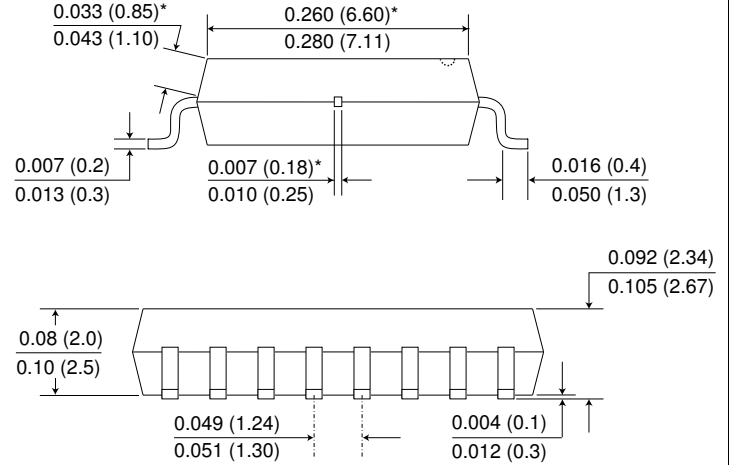
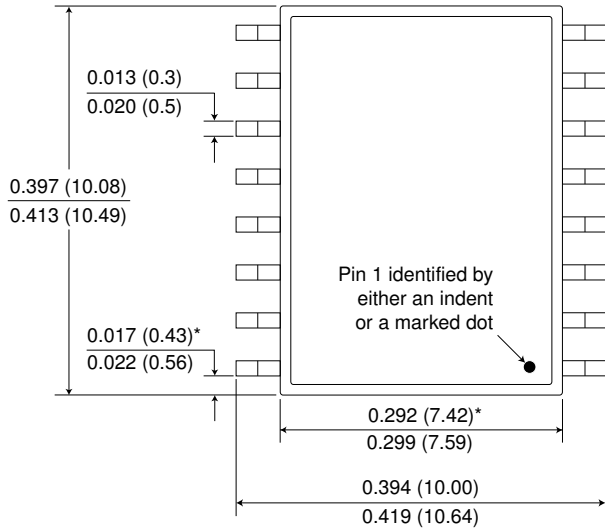

NOTE: Pin spacing is a BASIC dimension; tolerances do not accumulate

*Specified for True 8™ package to guarantee 8 mm creepage per IEC 60601.

Recommended Pad Layouts

8-pin MSOP Pad Layout

Dimensions in inches (mm); scale = approx. 5X

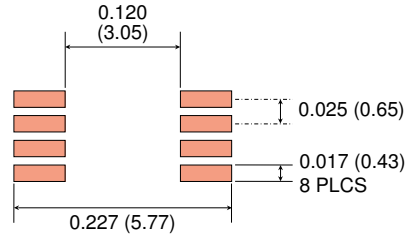

8-pin SOIC Pad Layout

Dimensions in inches (mm); scale = approx. 5X

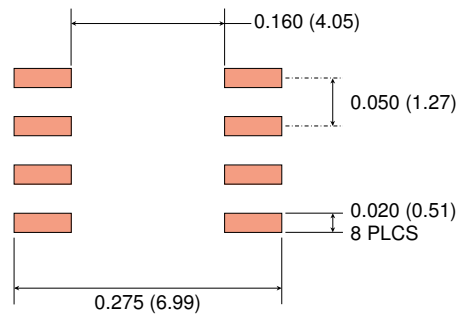

True 8™ 16-pin SOIC Pad Layout

Dimensions in inches (mm); scale = approx. 5X

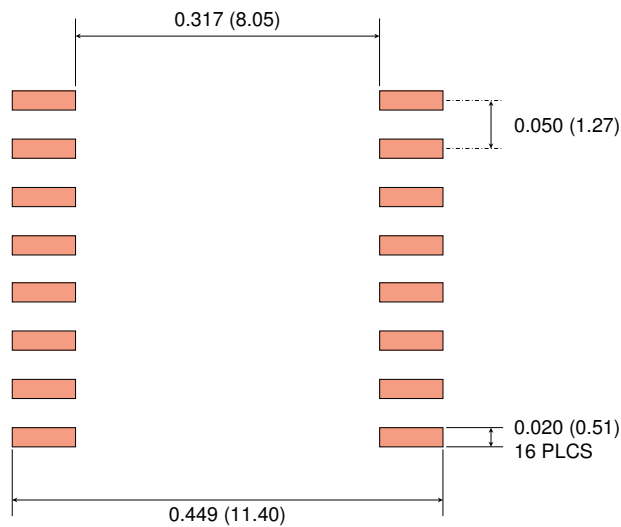

Ordering Information

IL 711 T - 3 E TR13

→ **Bulk Packaging**

Blank = Tube
TR7 = 7" Tape and Reel
TR13 = 13" Tape and Reel

→ **Package**

Blank = 80/20 Tin/Lead Plating
E = RoHS Compliant

→ **Package Type**

-1 = MSOP
-2 = PDIP
-3 = 0.15" 8-pin SOIC
Blank = True 8 (8mm creepage)

→ **Grade**

Blank = Standard
S = High Speed (150 Mbps)
T = High Temperature (125°C)
V = High Isolation Voltage
(6 kV True 8; 2.5 kV MSOP)

→ **Base Part Number**

711 = 2 Transmit Channels
712 = 1 Transmit Channel
1 Receive Channel
721 = 1 Transmit Channel
1 Receive Channel
(reverse pinout)

→ **Product Family**

IL = Isolators

Available Parts

Available Parts	Transmit Channels	Receive Channels	Mbps	Maximum Temperature	Isolation Voltage (RMS)	Package	RoHS
IL711-1E	2	0	110	100°C	1 kV	MSOP-8	Y
IL711-2	2	0	110	100°C	2.5 kV	PDIP-8	N
IL711-2E	2	0	110	100°C	2.5 kV	PDIP-8	Y
IL711-3	2	0	110	100°C	2.5 kV	SOIC-8	N
IL711-3E	2	0	110	100°C	2.5 kV	SOIC-8	Y
IL711S-1E	2	0	150	100°C	1 kV	MSOP-8	Y
IL711S-3E	2	0	150	100°C	2.5 kV	SOIC-8	Y
IL711T-1E	2	0	110	125°C	1 kV	MSOP-8	Y
IL711TV-1E	2	0	110	125°C	2.5 kV	MSOP-8	Y
IL711T-2	2	0	110	125°C	2.5 kV	PDIP-8	N
IL711T-2E	2	0	110	125°C	2.5 kV	PDIP-8	Y
IL711T-3	2	0	110	125°C	2.5 kV	SOIC-8	N
IL711T-3E	2	0	110	125°C	2.5 kV	SOIC-8	Y
IL711V-1E	2	0	110	100°C	2.5 kV	MSOP-8	Y
IL711VE	2	0	110	125°C	6 kV	True8	Y
IL712-1E	1	1	110	100°C	1 kV	MSOP-8	Y
IL712-2	1	1	110	100°C	2.5 kV	PDIP-8	N
IL712-2E	1	1	110	100°C	2.5 kV	PDIP-8	Y
IL712-3	1	1	110	100°C	2.5 kV	SOIC-8	N
IL712-3E	1	1	110	100°C	2.5 kV	SOIC-8	Y
IL712S-1E	1	1	150	100°C	1 kV	MSOP-8	Y
IL712S-3E	1	1	150	100°C	2.5 kV	SOIC-8	Y
IL712T-1E	1	1	110	125°C	1 kV	MSOP-8	Y
IL712TV-1E	1	1	110	125°C	2.5 kV	MSOP-8	Y
IL712T-2	1	1	110	125°C	2.5 kV	PDIP	N
IL712T-2E	1	1	110	125°C	2.5 kV	PDIP	Y
IL712T-3	1	1	110	125°C	2.5 kV	SOIC-8	N
IL712T-3E	1	1	110	125°C	2.5 kV	SOIC-8	Y
IL712V-1E	1	1	110	100°C	2.5 kV	MSOP	Y
IL721-3E	1	1	110	105°C	2.5 kV	SOIC-8	Y
IL721E	1	1	110	100°C	2.5 kV	True8	Y
IL721T-3E	1	1	110	125°C	2.5 kV	SOIC-8	Y
IL721VE	1	1	110	125°C	6 kV	True8	Y

All MSOP and SOIC part types are available on tape and reel.

ISB-DS-001-IL711/12-AO
August 2022

Changes

- Upgraded to IEC 60747-17 (VDE 0884-17):2021-10 (p. 3).
- Increased Working Voltage ratings based on latest VDE testing (p. 3).
- Added ATEX and IECEX certification for IS-to-IS intrinsically safe applications (p. 3).
- Replaced “Valid Part Numbers” with table on p. 17.

ISB-DS-001-IL711/12-AN

Changes

- Upgraded CMTI specifications.
- Added ATEX / IEC 60079 Intrinsic Safety pending (p. 3).

ISB-DS-001-IL711/12-AM

Changes

- Extended minimum operating power supplies to 2.7 volts.
- Explicitly listed part types for max. operating temperatures.
- Changed PDIP8 creepage specifications from 7.04 mm to 6.8 mm.
- Updated EMC standards.
- Deleted minimum magnetic field immunity specifications (not 100% tested).
- Revised thermal resistance specifications.
- Added Typical Performance Graphs.
- More detailed description of operation.

ISB-DS-001-IL711/12-AL

Changes

- Added IL711TV-1E and IL712TV-1E 125°C, 2.5 kV isolation MSOP configurations.
- Eliminated non-RoHS MSOPs.

ISB-DS-001-IL711/12-AK

Change

- Updated SOIC8 package outline drawing.

ISB-DS-001-IL711/12-AJ

Change

- Updated VDE Reinforced Isolation file number and description.

ISB-DS-001-IL711/12-AI

Changes

- Updated VDE certification standard to VDE V 0884-10.
- Upgraded “VE” Version Surge Immunity specification to 12.8 kV.
- Upgraded “VE” Version VDE 0884-10 rating to reinforced insulation.

ISB-DS-001-IL711/12-AH

Changes

- Increased V-Series isolation voltage to 6 kVRms.
- Increased typ. Total Barrier Thickness specification to 0.016 mm.
- Increased CTI min. specification to $\geq 600 V_{RMS}$.

ISB-DS-001-IL711/12-AG

Changes

- Added V-Series high isolation voltage versions (5 kV True 8 and 2.5 kV MSOP).
- More detailed “Available Parts” table.

ISB-DS-001-IL711/12-AF

Changes

- Added product illustrations to first page.
- Revised and added details to thermal characteristic specifications (p. 2).
- Added VDE 0884 Safety-Limiting Values (p. 3).

Datasheet Limitations

The information and data provided in datasheets shall define the specification of the product as agreed between NVE and its customer, unless NVE and customer have explicitly agreed otherwise in writing. All specifications are based on NVE test protocols. In no event however, shall an agreement be valid in which the NVE product is deemed to offer functions and qualities beyond those described in the datasheet.

Limited Warranty and Liability

Information in this document is believed to be accurate and reliable. However, NVE does not give any representations or warranties, expressed or implied, as to the accuracy or completeness of such information and shall have no liability for the consequences of use of such information.

In no event shall NVE be liable for any indirect, incidental, punitive, special or consequential damages (including, without limitation, lost profits, lost savings, business interruption, costs related to the removal or replacement of any products or rework charges) whether or not such damages are based on tort (including negligence), warranty, breach of contract or any other legal theory.

Right to Make Changes

NVE reserves the right to make changes to information published in this document including, without limitation, specifications and product descriptions at any time and without notice. This document supersedes and replaces all information supplied prior to its publication.

Use in Life-Critical or Safety-Critical Applications

Unless NVE and a customer explicitly agree otherwise in writing, NVE products are not designed, authorized or warranted to be suitable for use in life support, life-critical or safety-critical devices or equipment. NVE accepts no liability for inclusion or use of NVE products in such applications and such inclusion or use is at the customer's own risk. Should the customer use NVE products for such application whether authorized by NVE or not, the customer shall indemnify and hold NVE harmless against all claims and damages.

Applications

Applications described in this datasheet are illustrative only. NVE makes no representation or warranty that such applications will be suitable for the specified use without further testing or modification.

Customers are responsible for the design and operation of their applications and products using NVE products, and NVE accepts no liability for any assistance with applications or customer product design. It is customer's sole responsibility to determine whether the NVE product is suitable and fit for the customer's applications and products planned, as well as for the planned application and use of customer's third party customers. Customers should provide appropriate design and operating safeguards to minimize the risks associated with their applications and products.

NVE does not accept any liability related to any default, damage, costs or problem which is based on any weakness or default in the customer's applications or products, or the application or use by customer's third party customers. The customer is responsible for all necessary testing for the customer's applications and products using NVE products in order to avoid a default of the applications and the products or of the application or use by customer's third party customers. NVE accepts no liability in this respect.

Limiting Values

Stress above one or more limiting values (as defined in the Absolute Maximum Ratings System of IEC 60134) will cause permanent damage to the device. Limiting values are stress ratings only and operation of the device at these or any other conditions above those given in the recommended operating conditions of the datasheet is not warranted. Constant or repeated exposure to limiting values will permanently and irreversibly affect the quality and reliability of the device.

Terms and Conditions of Sale

In case an individual agreement is concluded only the terms and conditions of the respective agreement shall apply. NVE hereby expressly objects to applying the customer's general terms and conditions with regard to the purchase of NVE products by customer.

No Offer to Sell or License

Nothing in this document may be interpreted or construed as an offer to sell products that is open for acceptance or the grant, conveyance or implication of any license under any copyrights, patents or other industrial or intellectual property rights.

Export Control

This document as well as the items described herein may be subject to export control regulations. Export might require a prior authorization from national authorities.

Automotive Qualified Products

Unless the datasheet expressly states that a specific NVE product is automotive qualified, the product is not suitable for automotive use. It is neither qualified nor tested in accordance with automotive testing or application requirements. NVE accepts no liability for inclusion or use of non-automotive qualified products in automotive equipment or applications.

In the event that customer uses the product for design-in and use in automotive applications to automotive specifications and standards, customer (a) shall use the product without NVE's warranty of the product for such automotive applications, use and specifications, and (b) whenever customer uses the product for automotive applications beyond NVE's specifications such use shall be solely at customer's own risk, and (c) customer fully indemnifies NVE for any liability, damages or failed product claims resulting from customer design and use of the product for automotive applications beyond NVE's standard warranty and NVE's product specifications.

An ISO 9001 Certified Company

NVE Corporation
11409 Valley View Road
Eden Prairie, MN 55344-3617 USA
Telephone: (952) 829-9217

www.nve.com
e-mail: iso-info@nve.com

©NVE Corporation
All rights are reserved. Reproduction in whole or in part is prohibited without the prior written consent of the copyright owner.

ISB-DS-001-IL711/12-AO

August 2022

Looking for pricing, stock, or lifecycle information?

Click below to explore more details on WIN SOURCE:

 [View IL 711-1E on WIN SOURCE](#)

 [NVE Corp Information](#)

Optimize Your Supply Chain with WIN SOURCE Solutions

-  Global Sourcing Solution
-  Obsolete Management
-  Cost Control Management
-  Shortage Management
-  Alternative Solution
-  Excess Inventory Management