



**THE DATASHEET OF
IGCM10F60GAXKMA1**



CIPOS™ Mini

IGCM10F60GA

Description

The CIPOS™ module family offers the chance for integrating various power and control components to increase reliability and optimize PCB size and system cost. It is designed to control 3-phase motors in variable speed drives. The package concept is specially adapted to power applications, which need good thermal conduction and electrical isolation, but also less EMI and overload protection. To deliver excellent electrical performance, Infineon's leading-edge RC-Drives IGBTs are combined with an optimized SOI gate driver.

Features

Package

- Fully isolated dual in-line molded module
- Lead-free terminal plating; RoHS compliant

Inverter

- Reverse Conducting Drives IGBTs
- Rugged SOI gate driver technology with stability against transient and negative voltage
- Allowable negative V_s potential up to -11 V for signal transmission at $V_{BS} = 15$ V
- Integrated bootstrap functionality
- Overcurrent shutdown
- Built-in NTC thermistor for temperature monitor
- Undervoltage lockout at all channels
- Low-side emitter pins accessible for phase current monitoring (open emitter)
- Cross-conduction prevention
- All of 6 switches turn off during protection

Potential applications

- Home appliances, low power motor drives

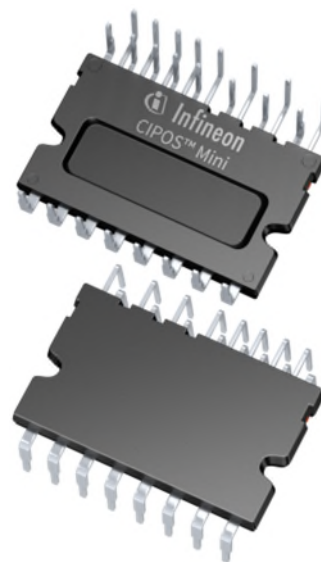

Product validation

Qualified for industrial applications according to the relevant tests of JEDEC47/20/22.

Table 1 Product Information

Base Part Number	Package Type	Standard Pack		Remarks
		Form	MOQ	
IGCM10F60GA	DIP 36x21	14 pcs / Tube	280 pcs	

Table of contents

Description 1

Features 1

Potential applications 1

Product validation 2

Table of contents 3

1 Internal Electrical Schematic 4

2 Pin Description 5

2.1 Pin Assignment 5

2.2 Pin Description 6

3 Absolute Maximum Ratings 8

3.1 Module Section 8

3.2 Inverter Section 8

3.3 Control Section 8

4 Thermal Characteristics 9

5 Recommended Operation Conditions 10

6 Static Parameters 11

6.1 Inverter Section 11

6.2 Control Section 11

7 Dynamic Parameters 12

7.1 Inverter Section 12

7.2 Control Section 12

8 Thermistor 13

9 Mechanical Characteristics and Ratings 14

10 Qualification Information 15

11 Diagrams and Tables 16

11.1 T_c Measurement Point 16

11.2 Backside Curvature Measurement Point 16

11.3 Switching Time Definition 17

12 Application Guide 18

12.1 Typical Application Schematic 18

12.2 Performance Chart 19

13 Package Outline 20

Revision history 21

1 Internal Electrical Schematic

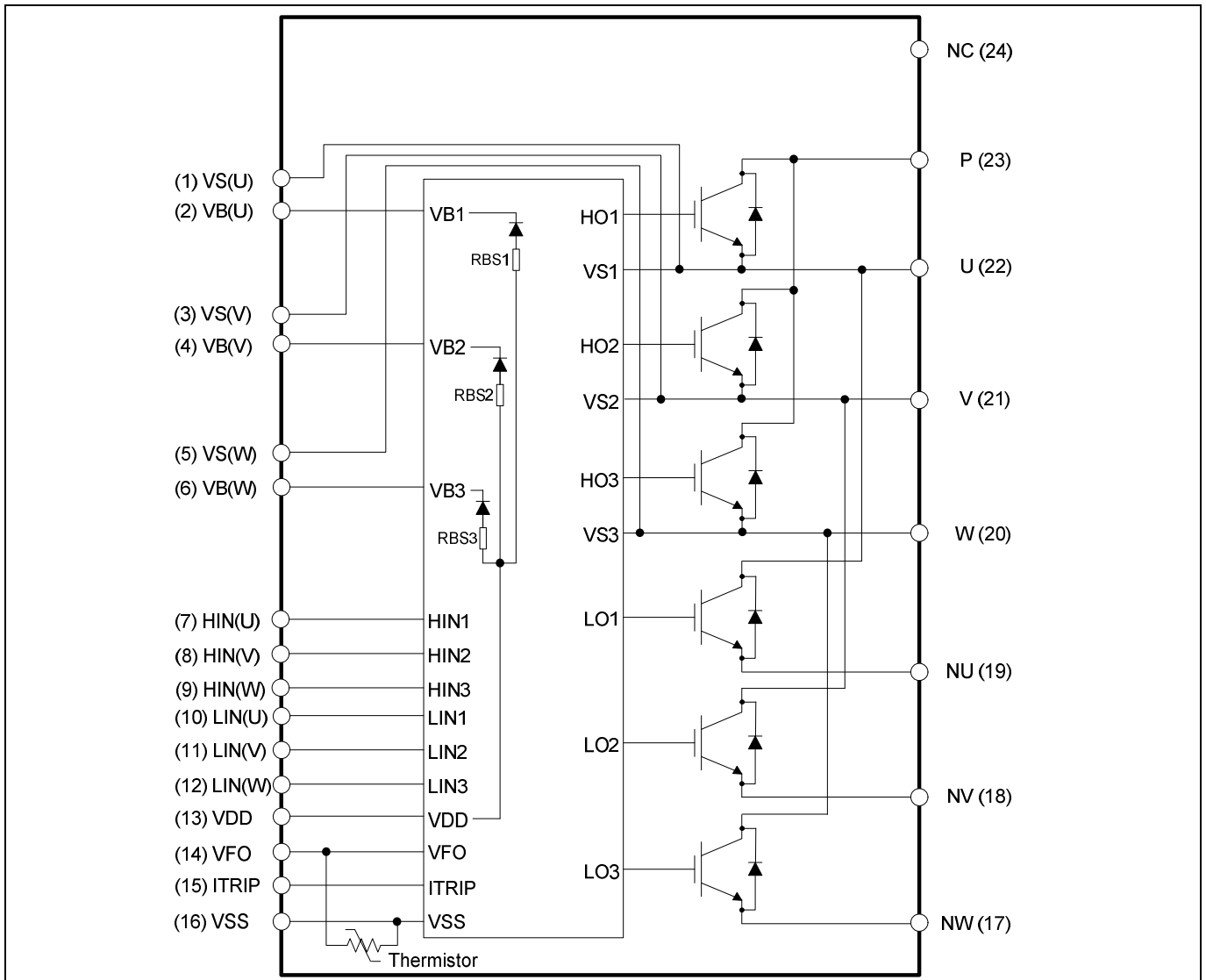

Figure 1 Internal electrical schematic

2 Pin Description

2.1 Pin Assignment

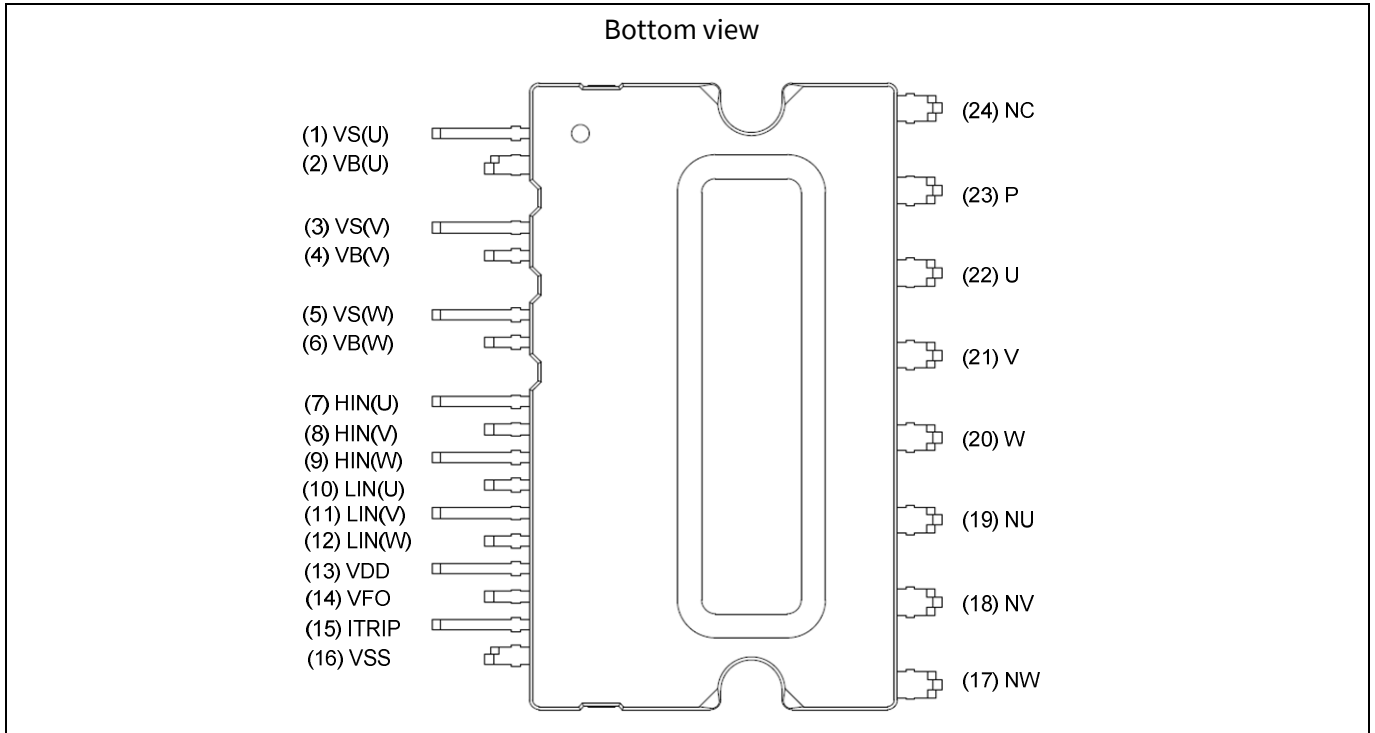

Figure 2 Pin configuration

Table 2 Pin assignment

Pin number	Pin name	Pin description
1	V _S (U)	U-phase high-side floating IC supply offset voltage
2	V _B (U)	U-phase high-side floating IC supply voltage
3	V _S (V)	V-phase high-side floating IC supply offset voltage
4	V _B (V)	V-phase high-side floating IC supply voltage
5	V _S (W)	W-phase high-side floating IC supply offset voltage
6	V _B (W)	W-phase high-side floating IC supply voltage
7	HIN(U)	U-phase high-side gate driver input
8	HIN(V)	V-phase high-side gate driver input
9	HIN(W)	W-phase high-side gate driver input
10	LIN(U)	U-phase low-side gate driver input
11	LIN(V)	V-phase low-side gate driver input
12	LIN(W)	W-phase low-side gate driver input
13	V _{DD}	Low-side control supply
14	V _{FO}	Fault output / temperature monitor
15	ITRIP	Overcurrent shutdown input
16	V _{SS}	Low-side control negative supply
17	NW	W-phase low-side emitter
18	NV	V-phase low-side emitter

Pin Description

19	NU	U-phase low-side emitter
20	W	Motor W-phase output
21	V	Motor V-phase output
22	U	Motor U-phase output
23	P	Positive bus input voltage
24	NC	No connection

2.2 Pin Description

HIN(U, V, W) and LIN(U, V, W) (Low-side and high-side control pins, Pin 7 - 12)

These pins are positive logic and they are responsible for the control of the integrated IGBTs. The Schmitt-trigger input thresholds of them are such to guarantee LSTTL and CMOS compatibility down to 3.3 V controller outputs. A pull-down resistor of about 5 kΩ is internally provided to pre-bias inputs during supply start-up, and a zener clamp is provided to protect the pins. Input Schmitt-trigger and noise filter provide noise rejection to short input pulses.

The noise filter suppresses control pulses shorter than the filter time $t_{FIL,IN}$. The Figure 4 describes how the filter works. An input pulse-width shorter than 1 μs is not recommended.

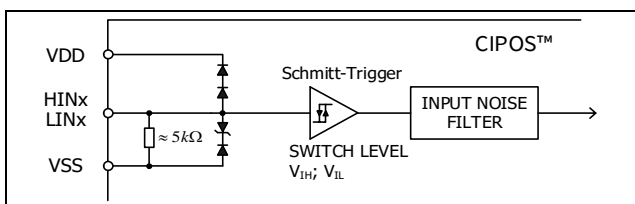

Figure 3 Input pin structure

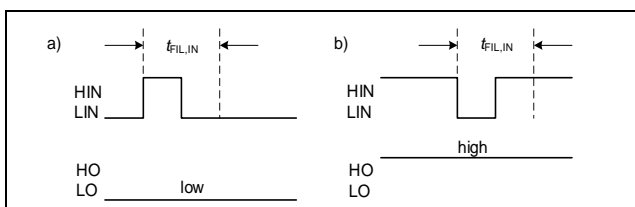

Figure 4 Input filter timing diagram

The integrated gate driver additionally provides a shoot-through prevention capability that avoids the simultaneous on-states of the same leg. When both inputs of the same leg are activated, only formerly activated one is remained activated so that the leg is kept steadily in a safe state.

A minimum deadtime insertion of typically 380 ns is also provided by driver, in order to reduce cross-conduction of the IGBTs.

V_{FO} (Fault-output and NTC, Pin 14)

The V_{FO} pin indicates a module failure in case of undervoltage at pin V_{DD} or in case of triggered overcurrent detection at ITRIP. An external pull-up resistor is required.

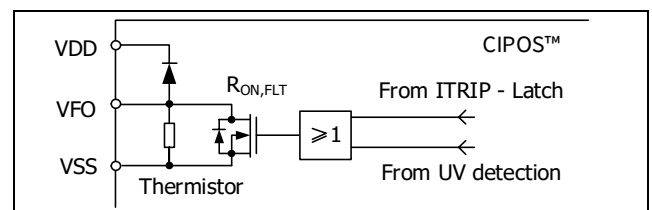

Figure 5 Internal circuit at pin V_{FO}

The pin 14 provides direct access to the NTC which is referenced to V_{SS}. An external pull-up resistor connected to +5 V ensures that the resulting voltage can be directly connected to the microcontroller.

ITRIP (Overcurrent detection function, Pin 15)

The CIPOS™ product family provides an overcurrent detection function by connecting the ITRIP input with the IGBT current feedback. The ITRIP comparator threshold (typ. 0.47 V) is referenced to V_{SS}. An input noise filter (t_{ITRIP} = typ. 530 ns) prevents the driver to detect false overcurrent events.

Overcurrent detection generates a shutdown of all outputs of the gate driver.

The fault-clear time is set to minimum 40 μs.

V_{DD}, V_{SS} (Low-side control supply and reference, Pin 13, 16)

V_{DD} is the control supply and it provides power both to input logic and to output stage. Input logic is referenced to V_{SS} ground.

Pin Description

The undervoltage circuit enables the device to operate at power on when a supply voltage of at least a typical voltage of $V_{DDUV+} = 12.1$ V is present.

The gate driver shuts down all the outputs, when the V_{DD} supply voltage is below $V_{DDUV-} = 10.4$ V. This prevents the IGBTs from critically low gate voltage levels during on-state and therefore from excessive power dissipation.

V_B (U, V, W) and V_S (U, V, W) (High-side supplies, Pin 1 - 6)

V_B to V_S is the high-side supply voltage. The high-side circuit can float with respect to V_{SS} following the high-side IGBT emitter voltage.

Due to the low power consumption, the floating driver stage is supplied by integrated bootstrap circuit.

The undervoltage detection operates with a rising supply threshold of typical $V_{BSUV+} = 12.1$ V and a falling threshold of $V_{BSUV-} = 10.4$ V.

V_S (U, V, W) provide a high robustness against negative voltage in respect of V_{SS} of -50 V transiently.

This ensures very stable designs even under harsh conditions.

NW, NV, NU (Low-side emitter, Pin 17 - 19)

The low-side emitters are available for current measurement of each phase leg. It is recommended to keep the connection to pin V_{SS} as short as possible to avoid unnecessary inductive voltage drops.

W, V, U (High-side emitter and low-side collector, Pin 20 - 22)

These pins are connected to motor U, V, W input pins

P (Positive bus input voltage, Pin 23)

The high-side IGBTs are connected to the bus voltage. It is noted that the bus voltage does not exceed 450 V.

Absolute Maximum Ratings

3 Absolute Maximum Ratings

($V_{DD} = 15\text{ V}$ and $T_J = 25^\circ\text{C}$, if not stated otherwise)

3.1 Module Section

Description	Symbol	Condition	Value	Unit
Storage temperature range	T_{STG}		-40 ~ 125	$^\circ\text{C}$
Operating case temperature	T_C	Refer to Figure 7	-40 ~ 125	$^\circ\text{C}$
Operating junction temperature	T_J		-40 ~ 150	$^\circ\text{C}$
Isolation test voltage	V_{ISO}	1 min, RMS, $f = 60\text{ Hz}$	2000	V

3.2 Inverter Section

Description	Symbol	Condition	Value	Unit
Max. blocking voltage	V_{CES}		600	V
DC link supply voltage of P-N	V_{PN}	Applied between P-N	450	V
DC link supply voltage (surge) of P-N	$V_{PN(surge)}$	Applied between P-N	500	V
Output current ¹	I_C	$T_C = 25^\circ\text{C}$, $T_J < 150^\circ\text{C}$	± 10	A
		$T_C = 100^\circ\text{C}$, $T_J < 150^\circ\text{C}$	± 6	
Maximum peak collector current	$I_{C(peak)}$	$T_C = 25^\circ\text{C}$, $T_J < 150^\circ\text{C}$ less than 1 ms	± 20	A
Power dissipation per IGBT	P_{tot}		26.1	W
Short circuit withstand time	t_{SC}	$V_{DC} \leq 400\text{ V}$, $T_J = 150^\circ\text{C}$	5	μs

3.3 Control Section

Description	Symbol	Condition	Value	Unit
High-side offset voltage	V_S		600	V
Repetitive peak reverse voltage of bootstrap diode	V_{RRM}		600	V
Module supply voltage	V_{DD}		-1 ~ 20	V
High-side floating supply voltage (V_B reference to V_S)	V_{BS}		-1 ~ 20	V
Input voltage (LIN, HIN, ITRIP)	V_{IN}		-1 ~ 10	V

¹ Pulse width and period are limited by junction temperature

4 Thermal Characteristics

Description	Symbol	Condition	Value			Unit
			Min.	Typ.	Max.	
Single IGBT thermal resistance, junction to case	R_{thJC}	See Figure 7 for T_C measurement point	-	-	4.79	K/W

5 Recommended Operation Conditions

All voltages are absolute voltages referenced to V_{SS} -potential unless otherwise specified.

Description	Symbol	Value			Unit
		Min.	Typ.	Max.	
DC link supply voltage of P-N	V_{PN}	0	-	400	V
Low-side supply voltage	V_{DD}	14.0	16.0	18.5	V
High-side floating supply voltage (V_B vs. V_S)	V_{BS}	13.5	-	18.5	V
Logic input voltages LIN, HIN, ITRIP	V_{IN} V_{ITRIP}	0	-	5	V
Inverter PWM carrier frequency	f_{PWM}	-	-	20	kHz
External deadtime between HIN and LIN	DT	1.0	-	-	μ s
Voltage between $V_{SS} - N$ (including surge)	V_{COMP}	-5	-	5	V
Minimum input pulse width	$PW_{IN(ON)}$ $PW_{IN(OFF)}$	1	-	-	μ s
Control supply variation	ΔV_{BS} ΔV_{DD}	-1 -1	- -	1 1	V/ μ s

Static Parameters

6 Static Parameters

($V_{DD} = V_{BS} = 15\text{ V}$ and $T_J = 25^\circ\text{C}$, if not stated otherwise)

6.1 Inverter Section

Description	Symbol	Condition	Value			Unit
			Min.	Typ.	Max.	
Collector-emitter voltage	$V_{CE(Sat)}$	$I_C = 6\text{ A}, T_J = 25^\circ\text{C}$ $I_C = 6\text{ A}, T_J = 150^\circ\text{C}$	- -	1.6 1.8	2.0 -	V
Collector-emitter leakage current	I_{CES}	$V_{CE} = 600\text{ V}$	-	-	1	mA
Diode forward voltage	V_F	$I_F = 6\text{ A}, T_J = 25^\circ\text{C}$ $I_F = 6\text{ A}, T_J = 150^\circ\text{C}$	- -	1.75 1.8	2.2 -	V

6.2 Control Section

Description	Symbol	Condition	Value			Unit
			Min.	Typ.	Max.	
Logic "1" input voltage (LIN, HIN)	V_{IH}		-	2.1	2.5	V
Logic "0" input voltage (LIN, HIN)	V_{IL}		0.7	0.9	-	V
ITRIP positive going threshold	$V_{IT,TH+}$		400	470	540	mV
ITRIP input hysteresis	$V_{IT,HYS}$		40	70	-	mV
V_{DD} and V_{BS} supply undervoltage positive going threshold	V_{DDUV+}		10.8	12.1	13.0	V
	V_{BSUV+}		10.8	12.1	13.0	
V_{DD} and V_{BS} supply undervoltage negative going threshold	V_{DDUV-}		9.5	10.4	11.2	V
	V_{BSUV-}		9.5	10.4	11.2	
V_{DD} and V_{BS} supply undervoltage lockout hysteresis	V_{DDUVH} V_{BSUVH}		1.0	1.7	-	V
Quiescent V_{Bx} supply current (V_{Bx} only)	I_{QBS}	$H_{IN} = 0\text{ V}$	-	300	500	μA
Quiescent V_{DD} supply current (V_{DD} only)	I_{QDD}	$L_{IN} = 0\text{ V}, H_{INX} = 5\text{ V}$	-	370	900	μA
Input bias current for LIN, HIN	I_{IN+}	$V_{IN} = 5\text{ V}$	-	1.0	1.5	mA
	I_{IN-}	$V_{IN} = 0\text{ V}$	-	2.0	-	μA
Input bias current for ITRIP	I_{ITRIP+}	$V_{ITRIP} = 5\text{ V}$	-	65	150	μA
Input bias current for V_{FO}	I_{FO}	$V_{FO} = 5\text{ V}, V_{ITRIP} = 0\text{ V}$	-	60	-	μA
V_{FO} output voltage	V_{FO}	$I_{FO} = 10\text{ mA}, V_{ITRIP} = 1\text{ V}$	-	0.5	-	V
Bootstrap diode forward voltage	V_{F_BSD}	$I_F = 20\text{ mA}$	-	2.6	-	V
Bootstrap diode resistance of U-phase ¹	$R_{BS(U)}$	$V_{S(V)} \text{ or } V_{S(W)} = 300\text{ V}, T_J = 25^\circ\text{C}$	-	35	-	Ω
		$V_{S(V)} \text{ and } V_{S(W)} = 0\text{ V}, T_J = 25^\circ\text{C}$	-	40	-	
		$V_{S(V)} \text{ or } V_{S(W)} = 300\text{ V}, T_J = 125^\circ\text{C}$	-	50	-	
		$V_{S(V)} \text{ and } V_{S(W)} = 0\text{ V}, T_J = 125^\circ\text{C}$	-	65	-	

¹ $R_{BS(V)}$ and $R_{BS(W)}$ have same values to $R_{BS(U)}$

7 Dynamic Parameters

($V_{DD} = 15\text{ V}$ and $T_J = 25^\circ\text{C}$, if not stated otherwise)

7.1 Inverter Section

Description	Symbol	Condition	Value			Unit
			Min.	Typ.	Max.	
Turn-on propagation delay time	t_{on}	$V_{LIN, HIN} = 5\text{ V}$, $I_C = 6\text{ A}$, $V_{DC} = 300\text{ V}$	-	670	-	ns
Turn-on rise time	t_r		-	20	-	ns
Turn-on switching time	$t_{c(on)}$		-	80	-	ns
Reverse recovery time	t_{rr}		-	110	-	ns
Turn-off propagation delay time	t_{off}	$V_{LIN, HIN} = 0\text{ V}$, $I_C = 6\text{ A}$, $V_{DC} = 300\text{ V}$	-	820	-	ns
Turn-off fall time	t_f		-	170	-	ns
Turn-off switching time	$t_{c(off)}$		-	180	-	ns
Short circuit propagation delay time	t_{SCP}	From $V_{IT, TH+}$ to 10% I_{SC}	-	1250	-	ns
IGBT turn-on energy (includes reverse recovery of diode)	E_{on}	$V_{DC} = 300\text{ V}$, $I_C = 6\text{ A}$ $T_J = 25^\circ\text{C}$ $T_J = 150^\circ\text{C}$	-	110	-	μJ
			-	155	-	
IGBT turn-off energy	E_{off}	$V_{DC} = 300\text{ V}$, $I_C = 6\text{ A}$ $T_J = 25^\circ\text{C}$ $T_J = 150^\circ\text{C}$	-	155	-	μJ
			-	220	-	
Diode recovery energy	E_{rec}	$V_{DC} = 300\text{ V}$, $I_C = 6\text{ A}$ $T_J = 25^\circ\text{C}$ $T_J = 150^\circ\text{C}$	-	45	-	μJ
			-	75	-	

7.2 Control Section

Description	Symbol	Condition	Value			Unit
			Min.	Typ.	Max.	
Input filter time ITRIP	t_{ITRIP}	$V_{ITRIP} = 1\text{ V}$	-	530	-	ns
Input filter time at LIN, HIN for turn on and off	$t_{FIL, IN}$	$V_{LIN, HIN} = 0\text{ V}$ or 5 V	-	290	-	ns
Fault clear time after ITRIP-fault	t_{FLTCLR}		40	65	200	μs
ITRIP to fault propagation delay	t_{FLT}	$V_{LIN, HIN} = 0$ or $V_{LIN, HIN} = 5\text{ V}$, $V_{ITRIP} = 1\text{ V}$	-	680	1000	ns
Internal deadtime	DT_{IC}		-	380	-	ns
Bootstrap diode reverse recovery time	t_{rr_BS}	$I_F = 0.6\text{ A}$, $di/dt = 80\text{ A}/\mu\text{s}$	-	50	-	ns

8 Thermistor

Description	Symbol	Condition	Value			Unit
			Min.	Typ.	Max.	
Resistance	R_{NTC}	$T_{NTC} = 25^{\circ}\text{C}$	-	85	-	$\text{k}\Omega$
B-constant of NTC (negative temperature coefficient) thermistor	B(25/100)		-	4092	-	K

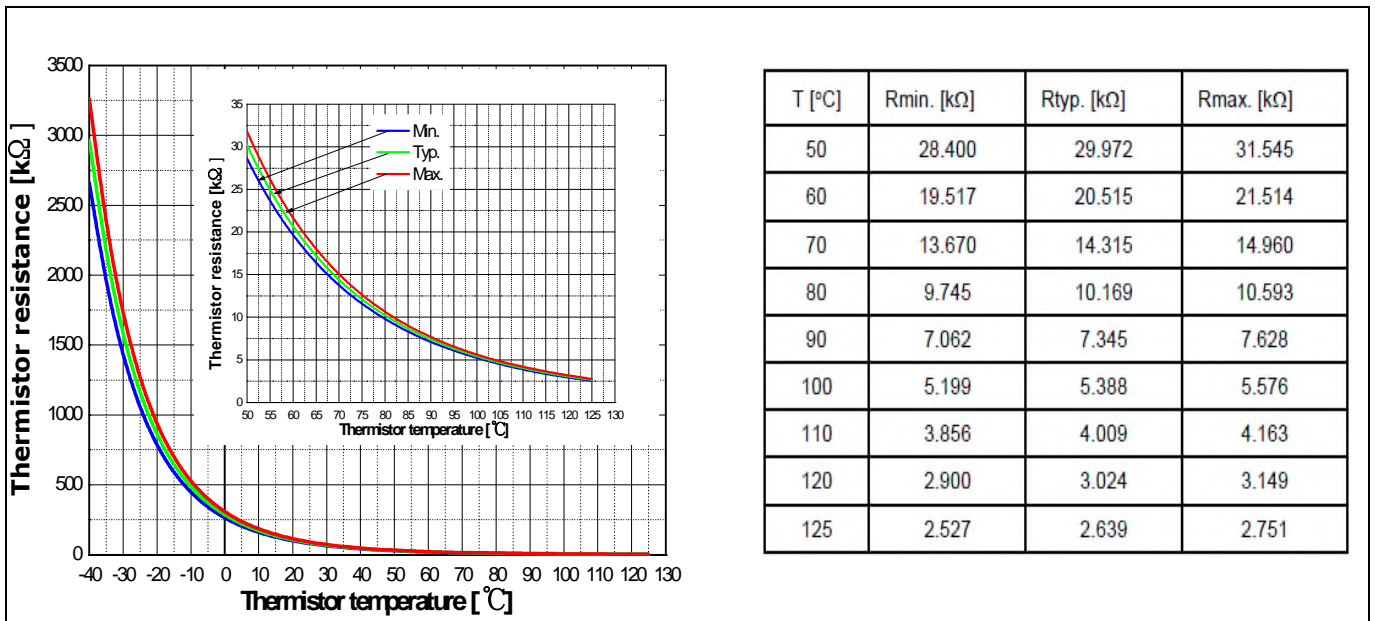

Figure 6 Thermistor resistance - temperature curve and table
(For more information, please refer to the application note)

9 Mechanical Characteristics and Ratings

Description	Condition	Value			Unit
		Min.	Typ.	Max.	
Comparative tracking index (CTI)		550	-	-	V
Mounting torque	M3 screw and washer	0.59	0.69	0.78	Nm
Backside curvature	Refer to Figure 8	-50	-	100	µm
Weight		-	6.15	-	g

10 Qualification Information

UL certification	File number: E314539	
Moisture sensitivity level (SOP23 only)	-	
RoHS compliant	Yes (Lead-free terminal plating)	
ESD	HBM(human body model) class	2
	CDM(charged device model) class	C3

11 Diagrams and Tables

11.1 T_c Measurement Point

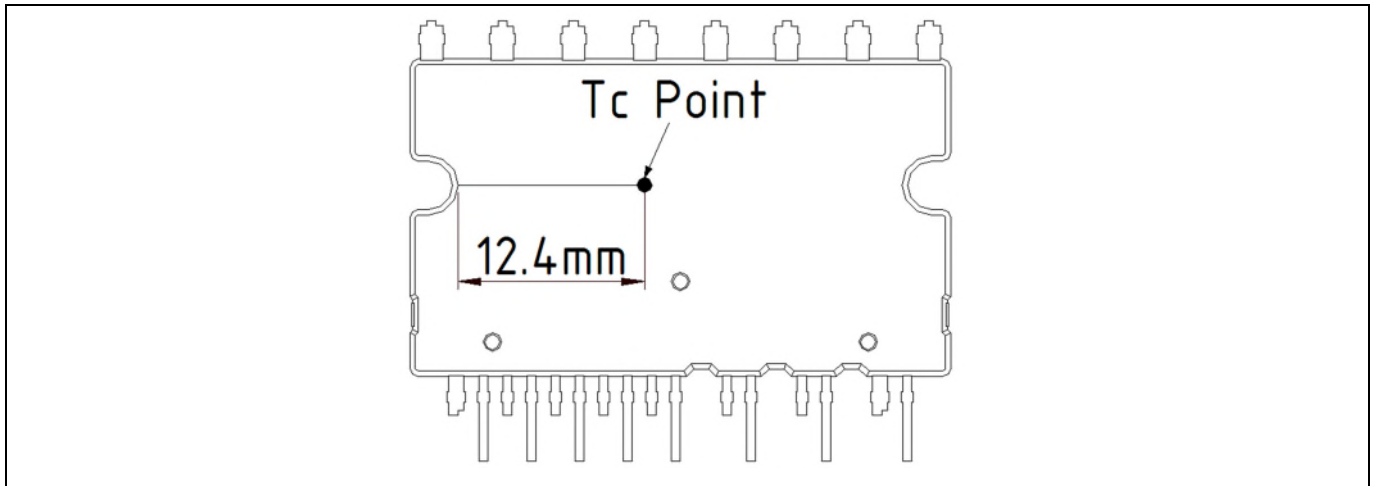

Figure 7 T_c measurement point¹

11.2 Backside Curvature Measurement Point

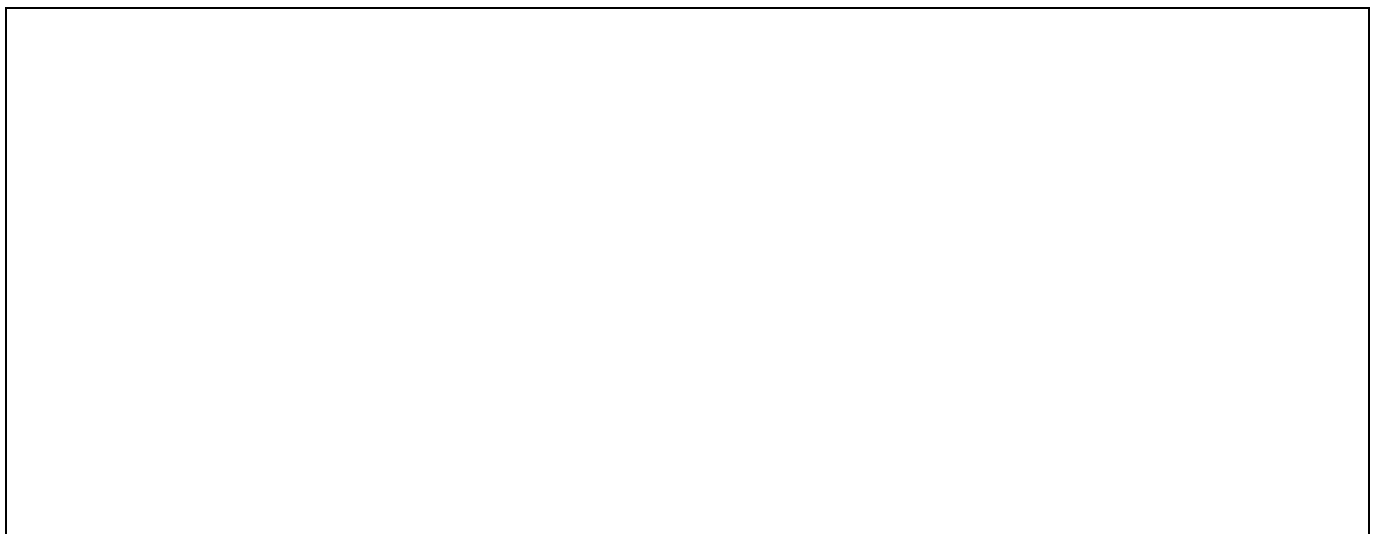

Figure 8 Backside curvature measurement position

¹Any measurement except for the specified point in Figure 7 is not relevant for the temperature verification and brings wrong or different information.

11.3 Switching Time Definition

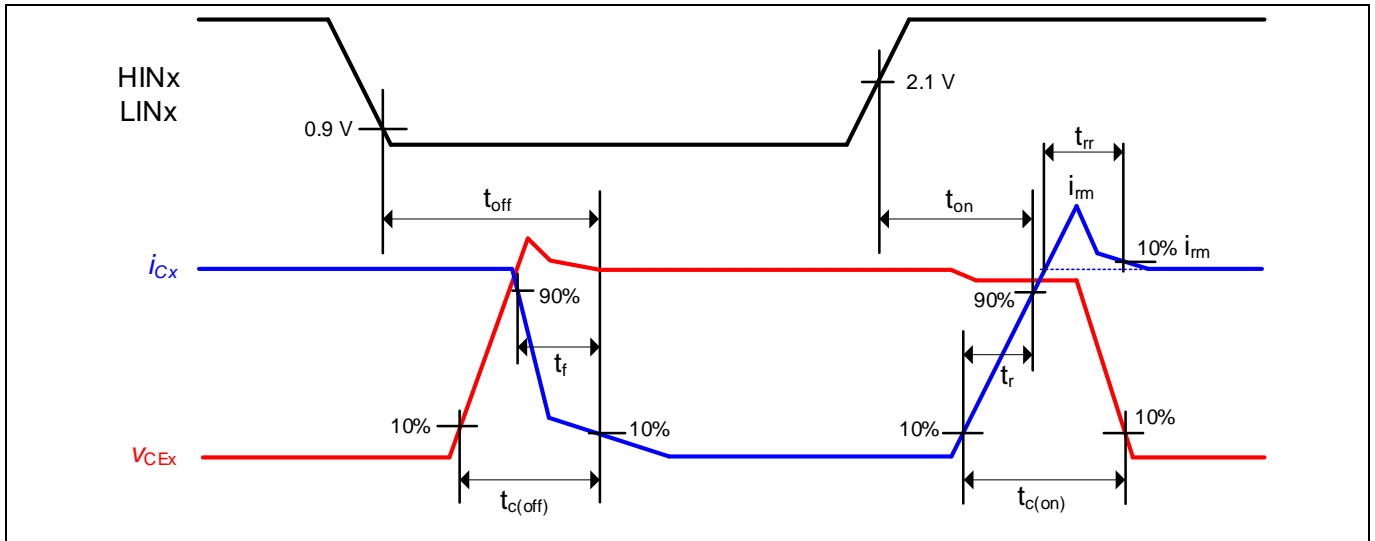

Figure 9 Switching time definition

12 Application Guide

12.1 Typical Application Schematic

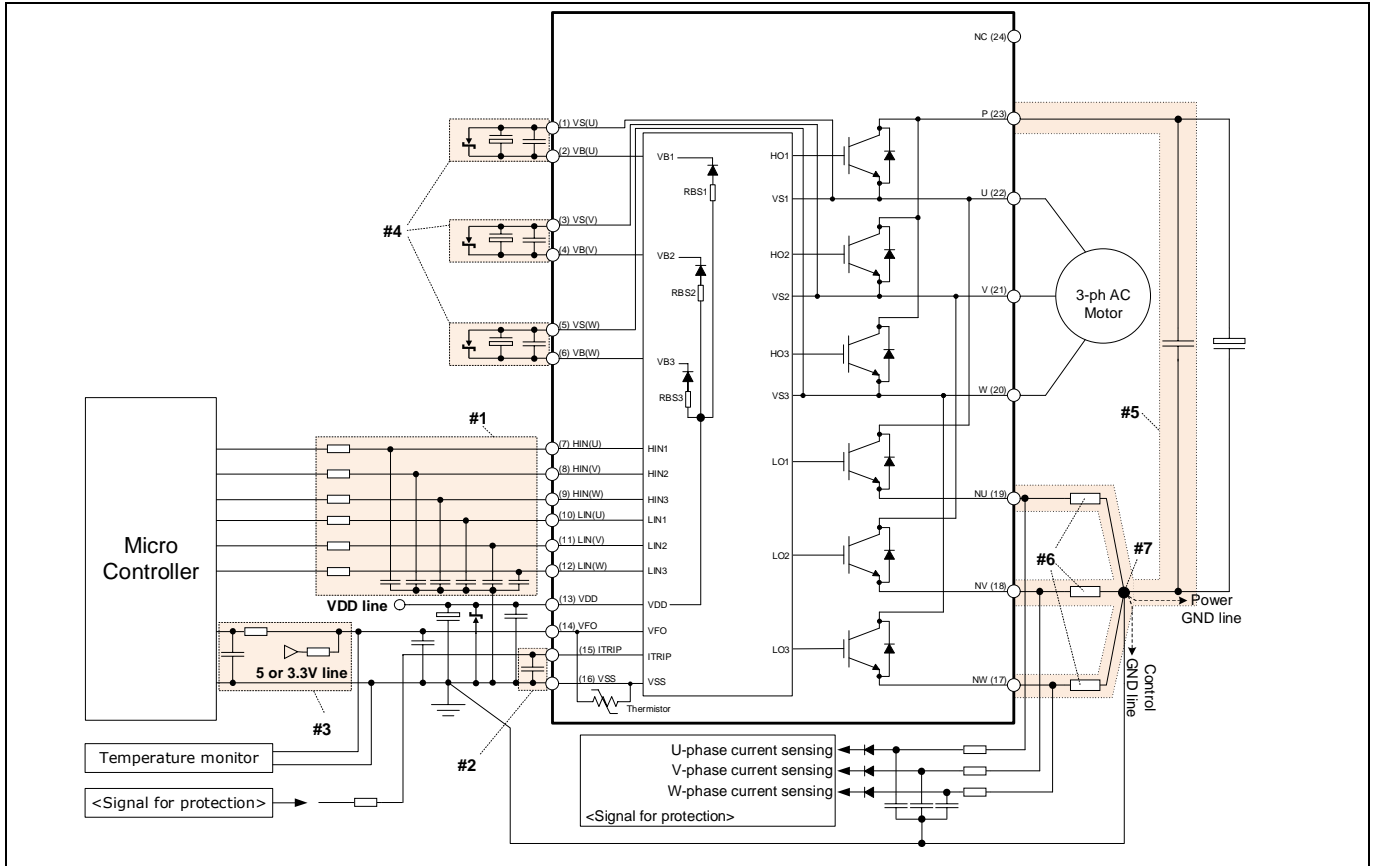

Figure 10 Typical application circuit

- #1 Input circuit
 - RC filter circuit can be used to reduce input signal noise (e.g. 100 Ω, 1 nF).
 - The filter capacitors should be placed close to the IPM (to V_{SS} pin especially).
- #2 ITRIP circuit
 - To prevent protection function errors, RC filter circuit is recommended.
 - The filter capacitor should be placed close to ITRIP and V_{SS} pins.
- #3 V_{F0} circuit
 - V_{F0} pin is an open-drain output. This signal line should be pulled up to the bias voltage of the 5 V/3.3 V with a proper resistor.
 - It is recommended that RC filter circuit is placed close to the controller.
- #4 V_B-V_S circuit
 - Capacitors for high-side floating supply voltage should be placed close to V_B and V_S pins.
- #5 Snubber capacitor
 - The wiring among the IPM, snubber capacitor and shunt resistors should be short as possible.
- #6 Shunt resistor
 - SMD-type resistors are strongly recommended to minimize stray inductance.
- #7 Ground pattern
 - Power ground and signal ground should be connected at a single point. It is recommended to connect them at the end of shunt resistor.

12.2 Performance Chart

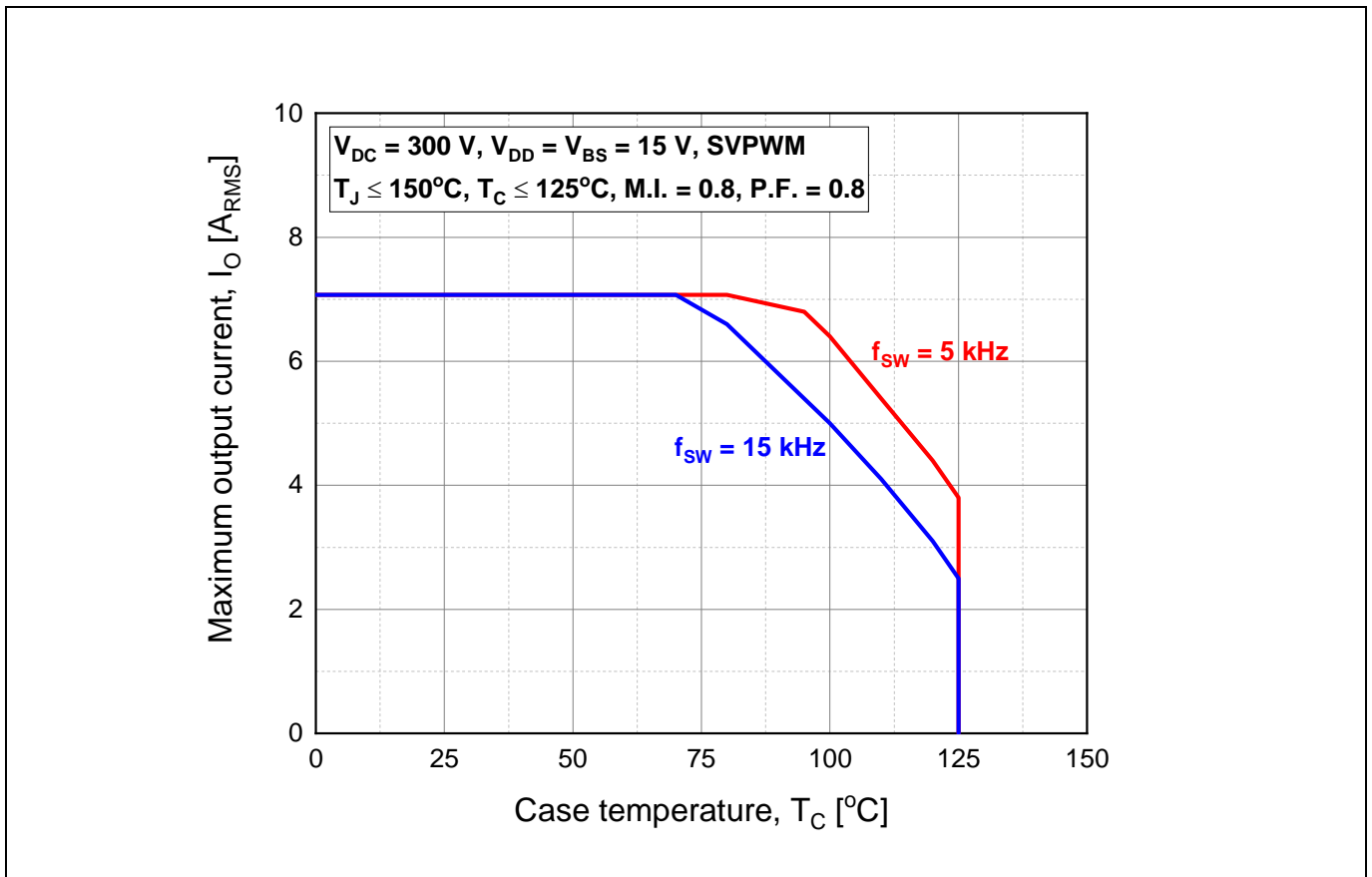

Figure 11 Maximum operating current SOA¹

¹This maximum operating current SOA is just one of example based on typical characteristics for this product. It can be changed by each user's actual operating conditions.

13 Package Outline

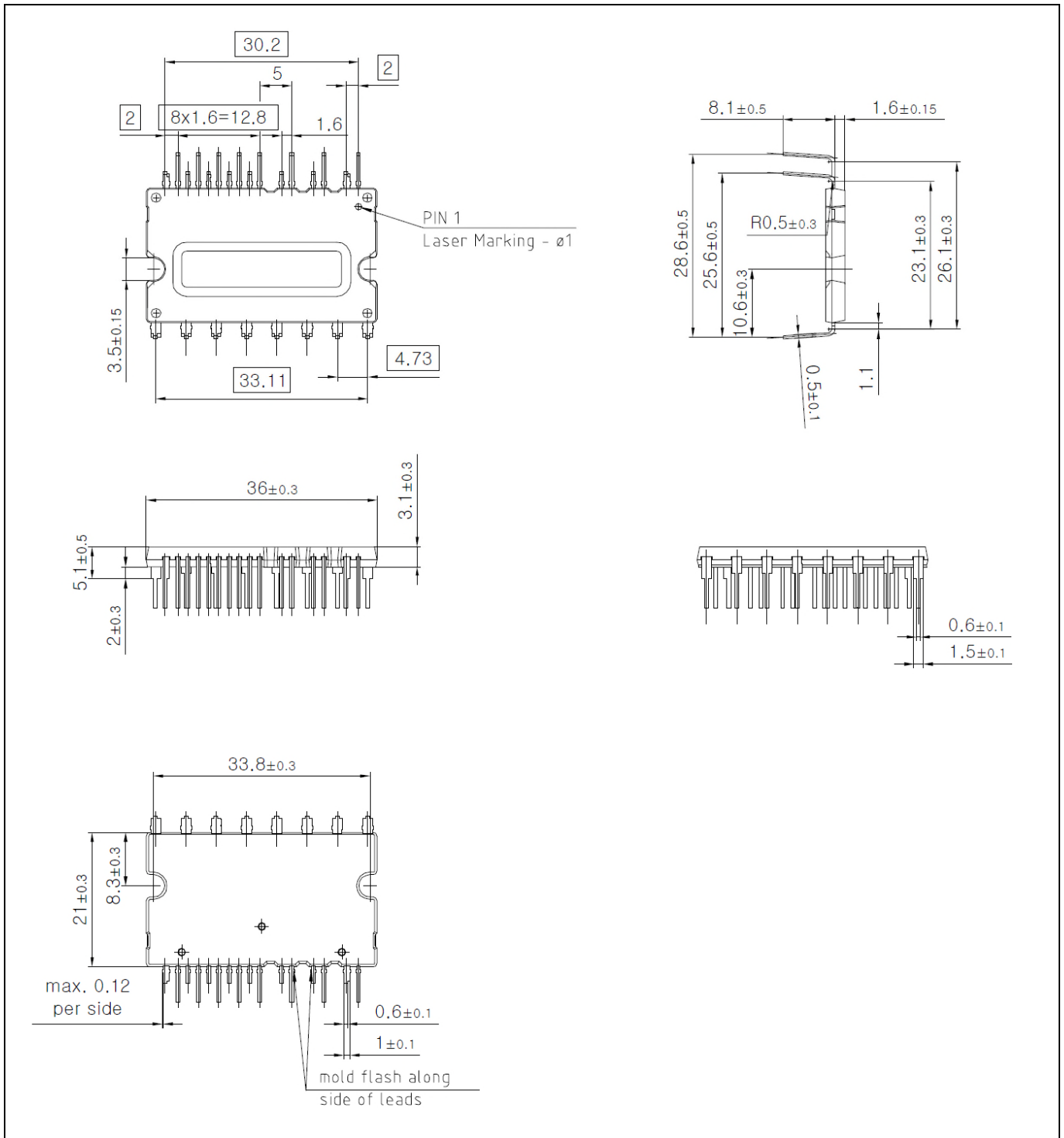

Figure 12 IGCM10F60GA

Revision history

Document version	Date of release	Description of changes
2.9	Sep. 2017	Maximum operating case temperature, $T_C = 125^\circ\text{C}$ Package outline update
3.0	Jan. 2023	Updated Figure 11
3.1	Jun. 2023	Corrected error in I_{IN} .

Trademarks

All referenced product or service names and trademarks are the property of their respective owners.

Edition 2023-06-23

Published by

Infineon Technologies AG

81726 Munich, Germany

© 2023 Infineon Technologies AG.

All Rights Reserved.

Do you have a question about this document?

Email: erratum@infineon.com

Document reference

ifx1

IMPORTANT NOTICE

The information given in this document shall in no event be regarded as a guarantee of conditions or characteristics ("Beschaffenheitsgarantie").

With respect to any examples, hints or any typical values stated herein and/or any information regarding the application of the product, Infineon Technologies hereby disclaims any and all warranties and liabilities of any kind, including without limitation warranties of non-infringement of intellectual property rights of any third party.

In addition, any information given in this document is subject to customer's compliance with its obligations stated in this document and any applicable legal requirements, norms and standards concerning customer's products and any use of the product of Infineon Technologies in customer's applications.

The data contained in this document is exclusively intended for technically trained staff. It is the responsibility of customer's technical departments to evaluate the suitability of the product for the intended application and the completeness of the product information given in this document with respect to such application.

For further information on the product, technology, delivery terms and conditions and prices please contact your nearest Infineon Technologies office (www.infineon.com).

Please note that this product is not qualified according to the AEC Q100 or AEC Q101 documents of the Automotive Electronics Council.



WARNINGS

Due to technical requirements products may contain dangerous substances. For information on the types in question please contact your nearest Infineon Technologies office.

Except as otherwise explicitly approved by Infineon Technologies in a written document signed by authorized representatives of Infineon Technologies, Infineon Technologies' products may not be used in any applications where a failure of the product or any consequences of the use thereof can reasonably be expected to result in personal injury.

Looking for pricing, stock, or lifecycle information?

Click below to explore more details on WIN SOURCE:

-  [View IGCM10F60GAXKMA1 on WIN SOURCE](#)
-  [Infineon Technologies Information](#)

Optimize Your Supply Chain with WIN SOURCE Solutions

-  Global Sourcing Solution
-  Obsolete Management
-  Cost Control Management
-  Shortage Management
-  Alternative Solution
-  Excess Inventory Management