



# THE DATASHEET OF HMC917LP3ETR



## SMT MMIC x4 ACTIVE FREQUENCY MULTIPLIER, 6 - 10 GHz OUTPUT



### Typical Applications

The HMC917LP3E is Ideal for:

- Microwave Radio & VSAT
- Military Radios, Radar & ECM
- Test Instrumentation

### Features

- Output Power: 2 dBm Typical
- Spurious Suppression: >20 dBc
- SSB Phase Noise: -148 dBc/Hz @ 100 kHz Offset
- Single Supply: 5V@ 91 mA
- 16 Lead 3x3 mm SMT Package: 9mm<sup>2</sup>

### Functional Diagram

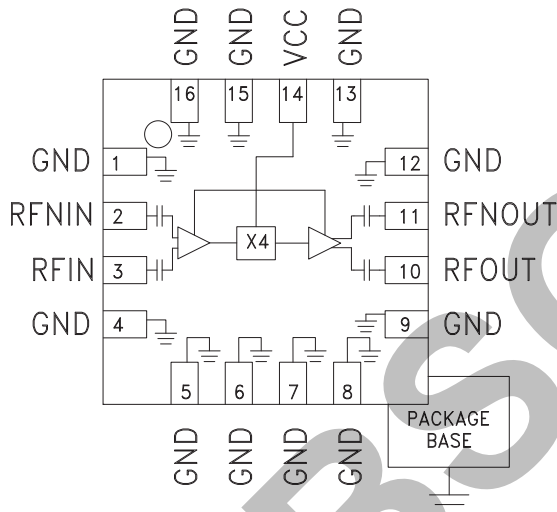

### General Description

The HMC917LP3E is an active x4 frequency multiplier housed in a 3x3 mm leadless QFN surface mount package. Power output is 2 dBm typical from a single +5V supply and varies little vs. input power, temperature and supply voltage. Suppression of undesired fundamental and spurious is 20 dBc typical with respect to output signal level. The low additive SSB phase noise of -148 dBc/Hz at 100 kHz offset helps the user maintain good system noise performance. The HMC917LP3E is ideal for use in LO multiplier chains allowing reduced parts count versus traditional approaches.

### Electrical Specifications, $T_A = +25^\circ \text{C}$ , $V_{CC} = 5V$ [1]

Parameter	Min.	Typ.	Max.	Units
Frequency Range, Input	1.5 - 2.5			GHz
Frequency Range, Output	6 - 10			GHz
Input Power Range	0	5	10	dBm
Output Power Range	2			dBm
Spurious	-20			dBc
Input Return Loss	7			dB
Output Return Loss	12			dB
SSB Phase Noise (100 kHz Offset)	Pin = +5 dBm	-148		dBc/Hz
Supply Current (I <sub>CC</sub> )	91			mA

[1] Single-ended operation



**SMT MMIC x4 ACTIVE  
FREQUENCY MULTIPLIER, 6 - 10 GHz OUTPUT**

**Output Power vs. Temperature @ 0 dBm Drive Level [1]**

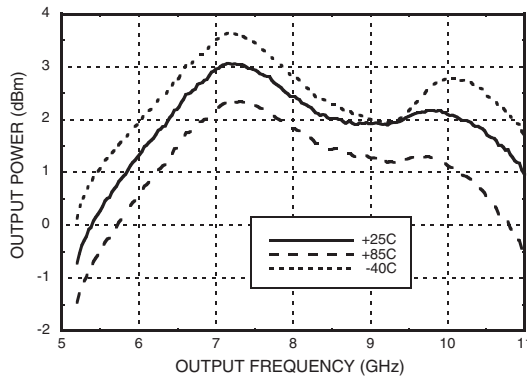

**Output Power vs. Drive Level, T = 25 °C [1]**

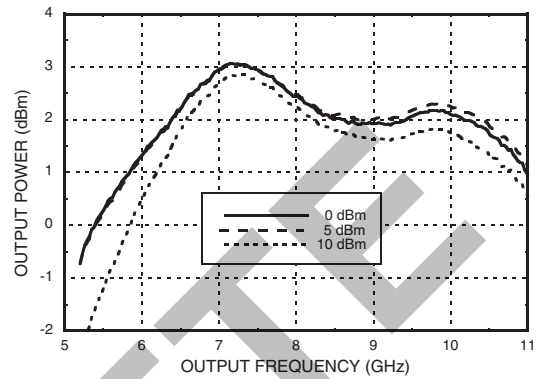

**Output Power vs. Supply Voltage @ 0 dBm Drive Level, T = 25 °C [1]**

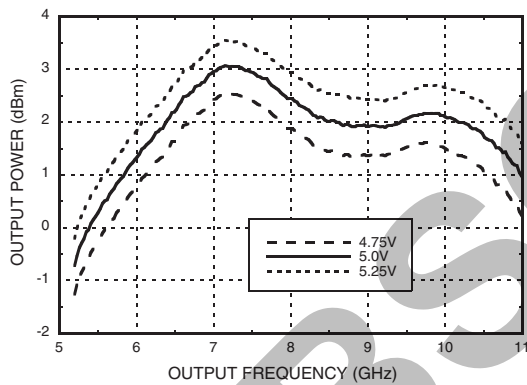

**Spurious Output vs. Fin Pin = +5 dBm, T = 25 °C [1]**

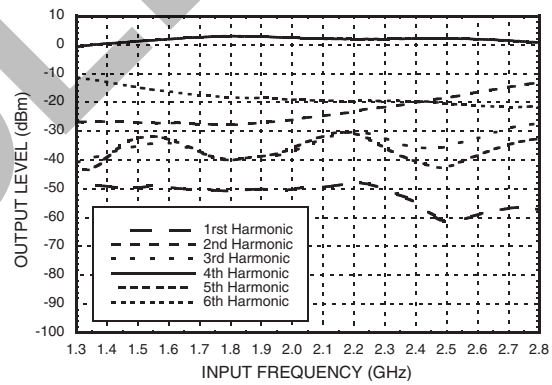

**Input Return Loss vs. Temperature [1]**

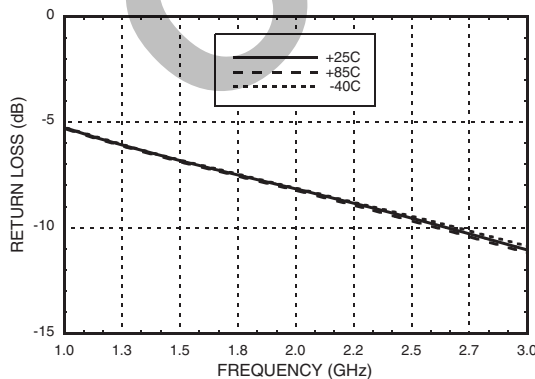

**Output Return Loss vs. Temperature [1]**

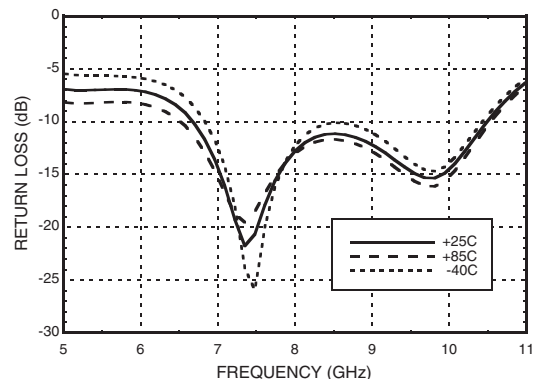

[1] All data shown is single-ended operation

Information furnished by Analog Devices is believed to be accurate and reliable. However, no responsibility is assumed by Analog Devices for its use, nor for any infringements of patents or other rights of third parties that may result from its use. Specifications subject to change without notice. No license is granted by implication or otherwise under any patent or patent rights of Analog Devices. Trademarks and registered trademarks are the property of their respective owners.

For price, delivery, and to place orders: Analog Devices, Inc., One Technology Way, P.O. Box 9106, Norwood, MA 02062-9106 Phone: 781-329-4700 • Order online at [www.analog.com](http://www.analog.com) Application Support: Phone: 1-800-ANALOG-D



**SMT MMIC x4 ACTIVE  
FREQUENCY MULTIPLIER, 6 - 10 GHz OUTPUT**

**SSB Phase Noise vs. Pin**  
*F<sub>out</sub> = 8 GHz, T = 25 °C [1]*

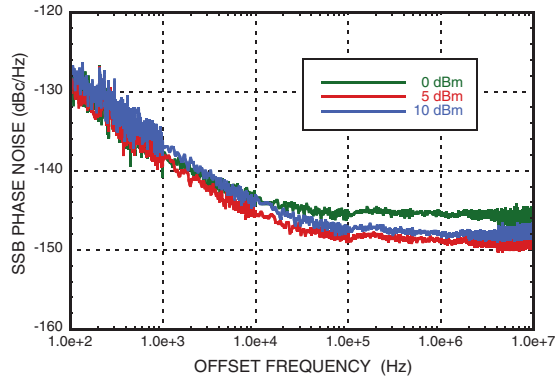

**I<sub>cc</sub> vs. Temperature [1]**

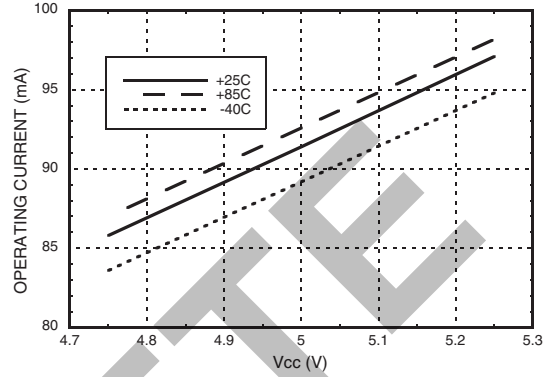

**Absolute Maximum Ratings**

RF Input (Vcc = +5V)	+20 dBm
Vcc	+6V
Storage Temperature	-65 to +150 °C
ESD Sensitivity (HBM)	150V

**Reliability Information**

Junction Temperature To Maintain 1 Million Hour MTF	150 °C
Nominal Junction Temperature (T = 85 °C)	101.4 °C
Thermal Resistance (Junction to GND paddle, 5V supply)	35.4 °C/W
Operating Temperature	-40 °C to + 85 °C



**ELECTROSTATIC SENSITIVE DEVICE  
OBSERVE HANDLING PRECAUTIONS**

[1] All data shown is single-ended operation

Information furnished by Analog Devices is believed to be accurate and reliable. However, no responsibility is assumed by Analog Devices for its use, nor for any infringements of patents or other rights of third parties that may result from its use. Specifications subject to change without notice. No license is granted by implication or otherwise under any patent or patent rights of Analog Devices. Trademarks and registered trademarks are the property of their respective owners.

For price, delivery, and to place orders: Analog Devices, Inc., One Technology Way, P.O. Box 9106, Norwood, MA 02062-9106 Phone: 781-329-4700 • Order online at [www.analog.com](http://www.analog.com) Application Support: Phone: 1-800-ANALOG-D



**SMT MMIC x4 ACTIVE  
FREQUENCY MULTIPLIER, 6 - 10 GHz OUTPUT**

**Outline Drawing**

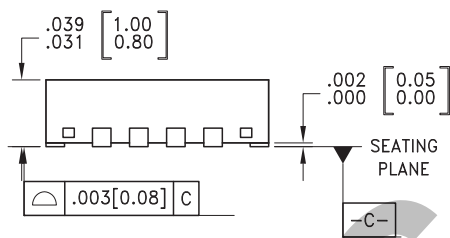
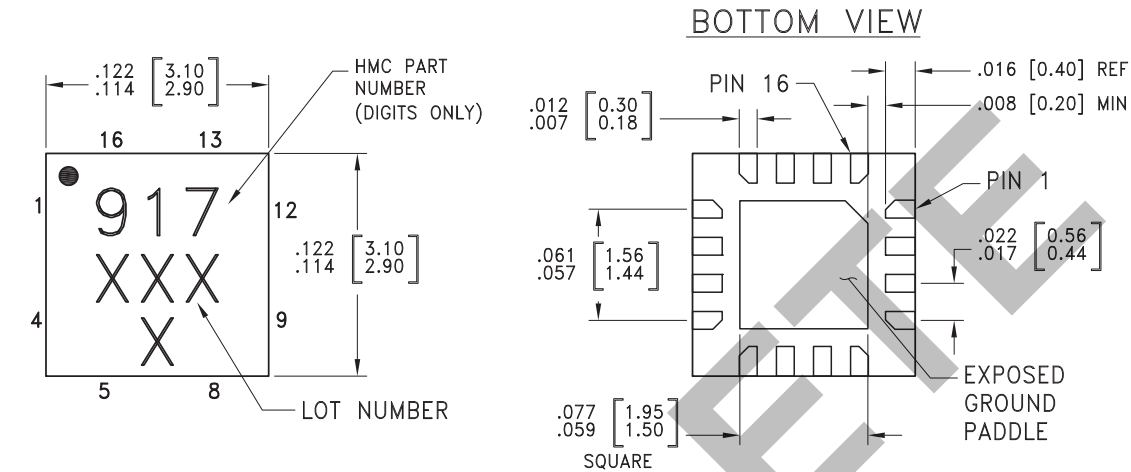

- NOTES:
1. LEADFRAME MATERIAL: COPPER ALLOY
  2. DIMENSIONS ARE IN INCHES [MILLIMETERS]
  3. LEAD SPACING TOLERANCE IS NON-CUMULATIVE.
  4. PAD BURR LENGTH SHALL BE 0.15mm MAXIMUM.  
PAD BURR HEIGHT SHALL BE 0.05mm MAXIMUM.
  5. PACKAGE WARP SHALL NOT EXCEED 0.05mm.
  6. ALL GROUND LEADS AND GROUND PADDLE MUST BE SOLDERED TO PCB RF GROUND.
  7. REFER TO HITTITE APPLICATION NOTE FOR SUGGESTED LAND PATTERN.

**Package Information**

Part Number	Package Body Material	Lead Finish	MSL Rating	Package Marking <sup>[1]</sup>
HMC917LP3E	RoHS-compliant Low Stress Injection Molded Plastic	100% matte Sn	MSL1 <sup>[2]</sup>	917 XXXX

[1] 4-Digit lot number XXXX

[2] Max peak reflow temperature of 260 °C



## SMT MMIC x4 ACTIVE FREQUENCY MULTIPLIER, 6 - 10 GHz OUTPUT

### Pin Description

Pin Number	Function	Description	Interface Schematic
1, 4 - 9, 12, 13, 15, 16	GND	These pins and exposed paddle must be connected to RF/DC ground.	
2	RFNIN (or GND)	This pin is AC coupled and matched to 50 ohms, and is 180° out of phase with pin 3 for differential operation. RF/DC ground for single ended operation.	
3	RFIN	This pin is AC coupled and matched to 50 ohms	
10	RFOUT	This pin is AC coupled and matched to 50 ohms	
11	RFNOUT	This pin is AC coupled and matched to 50 ohms, and is 180° out of phase with pin 10 for differential operation. Terminate in 50 ohms for single ended operation.	
14	Vcc	Supply voltage +5V	

OBSOLETE



**SMT MMIC x4 ACTIVE  
FREQUENCY MULTIPLIER, 6 - 10 GHz OUTPUT**

**Evaluation PCB**

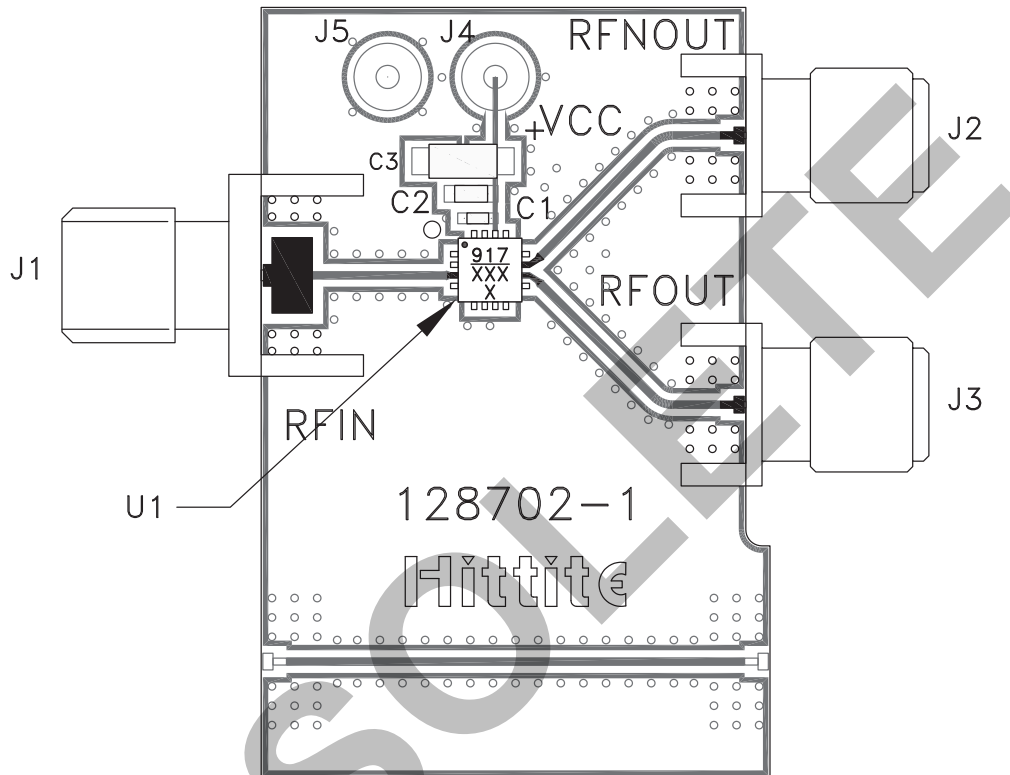

**List of Materials for Evaluation PCB 128383 [1]**

Item	Description
J1 - J3	PCB Mount SMA Connector
J4, J5	DC Pin
C1	100 pF Capacitor, 0402 Pkg.
C2	1000 pF Capacitor, 0402 Pkg.
C3	4.7 $\mu$ F Capacitor, 0402 Pkg.
U1	HMC917LP3E x4 Active Multiplier
PCB [2]	128702 Eval Board

[1] Reference this number when ordering complete evaluation PCB

[2] Circuit Board Material: Rogers 4350

The circuit board used in the application should be generated with proper RF circuit design techniques. Signal lines should have 50 Ohm impedance while the package ground leads and exposed paddle should be connected directly to the ground plane similar to that shown. The evaluation circuit board shown is available from Hittite upon request.

## Looking for pricing, stock, or lifecycle information?

Click below to explore more details on WIN SOURCE:

-  [View HMC917LP3ETR on WIN SOURCE](#)
-  [Analog Devices Inc. Information](#)

## Optimize Your Supply Chain with WIN SOURCE Solutions

-  Global Sourcing Solution
-  Obsolete Management
-  Cost Control Management
-  Shortage Management
-  Alternative Solution
-  Excess Inventory Management