



THE DATASHEET OF
046801.5NR



Surface Mount Fuses

Thin Film > 1206 Size > Slo-Blo® Fuse > 468 Series

468 Series 1206 Slo-Blo® Fuse

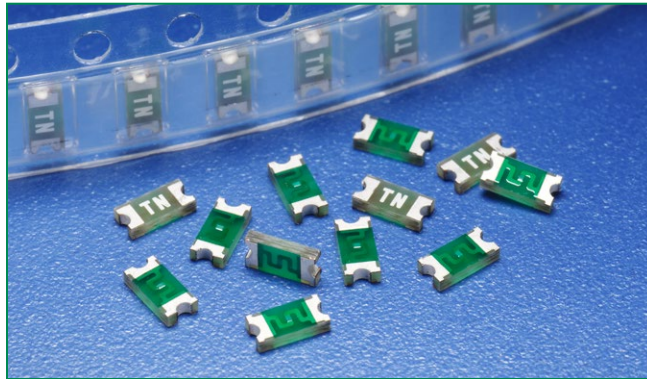

Description

The 468 Series Slo-Blo® Surface Mount Fuse (SMF) is a small (1206 size) thin-film device designed for secondary protection of circuits used in space constrained applications such as hand-held portable electronic devices. This series is 100% lead-free and meets the requirements of the RoHS directive. New Halogen-Free 468 Series fuses are available—to order use the “HF” suffix. See Part Numbering section for additional information.

Agency Approvals

AGENCY	AGENCY FILE NUMBER	AMPERE RANGE
	E10480	0.5A - 3A
	29862	0.5A - 3A

Electrical Characteristics for Series

% of Ampere Rating	Opening Time at 25°C
100%	4 hours, Minimum
200%	1 sec., Min.; 120 sec., Max.
300%	0.05 sec., Min.; 1.5 sec., Max
800%	0.0015 sec., Min.; .05 sec., Max.

Features

- Complies with electronic industry environmental standards for lead reduction.
- Product is compatible with lead-free solders and higher temperature profiles.
- Time delay feature withstands high inrush currents and prevents nuisance openings.
- Package is visually distinct from fast-acting version for easy identification.
- Top side marking allows visual verification of amperage rating.
- RoHS, lead-free and halogen-free compliant.

Additional Information



Datasheet



Resources



Samples

Applications

Secondary protection for space constrained applications:

- Cell phones
- Battery packs
- Digital cameras
- DVD players
- Hard disk drives.

Electrical Specifications by Item

Ampere Rating (A)	Amp Code	Max Voltage Rating (V)	Interrupting Rating	Nominal Cold Resistance (Ohms)	Nominal Melting I ² t (A ² sec)	Nom Voltage Drop (mV)	Nom Power Dissipation (W)	Agency Approvals	
0.50	.500	63	50A @63 VAC/VDC	0.27000	0.0310	156.77	0.0784	x	x
1.00	001.	63		0.0790	0.1270	94.70	0.0947	x	x
1.50	01.5	63		0.0440	0.2880	82.32	0.1235	x	x
2.00	002.	63	35A @63 VAC 50A @63 VDC	0.0325	0.5060	77.27	0.1545	x	x
2.50	02.5	63		0.0240	1.0110	73.92	0.1848	x	x
3.00	003.	32	50A @32 VAC/VDC	0.01950	1.2700	72.95	0.2189	x	x

1. Measured at 10% of rated current, 25°C.
2. Measured at rated voltage.

Temperature Re-rating Curve

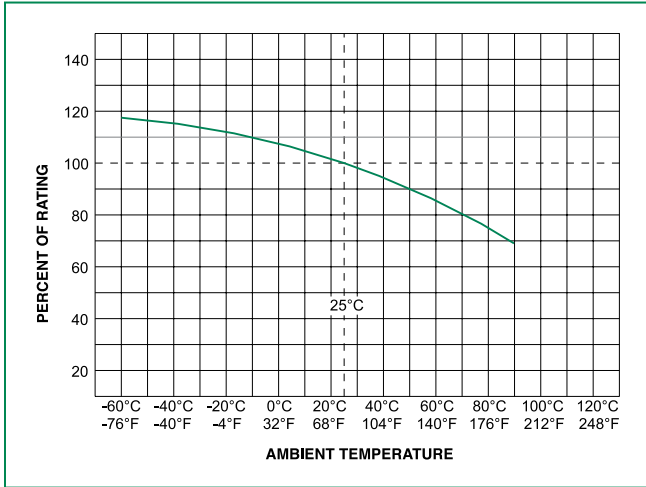

- Note:
1. Re-rating depicted in this curve is in addition to the standard derating of 25% for continuous operation.
- Example:
- For continuous operation at 70 degrees celsius, the fuse should be derated as follows:
 $I = (0.75)(0.80)I_{RAT} = (0.60)I_{RAT}$
2. The temperature derating curve represents the nominal conditions. For questions about temperature derating curve, please consult Littelfuse technical support for assistance.

Average Time Current Curves

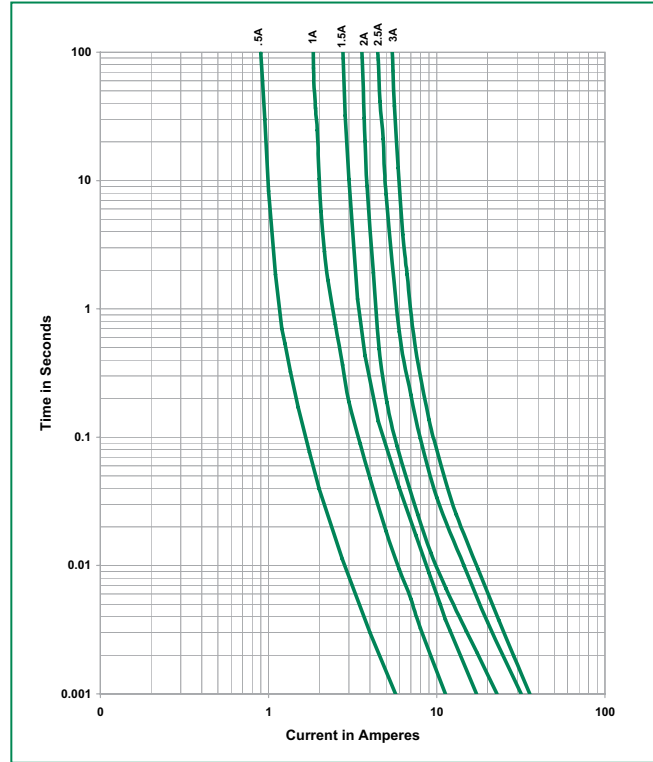

Soldering Parameters

Reflow Condition		Pb – Free assembly
Pre Heat	- Temperature Min ($T_{s(min)}$)	150°C
	- Temperature Max ($T_{s(max)}$)	200°C
	- Time (Min to Max) (t_s)	60 – 180 secs
Average ramp up rate (Liquidus Temp (T_L) to peak)		5°C/second max
$T_{s(max)}$ to T_L - Ramp-up Rate		5°C/second max
Reflow	- Temperature (T_L) (Liquidus)	217°C
	- Temperature (t_L)	60 – 150 seconds
Peak Temperature (T_P)		260 ^{+0/-5} °C
Time within 5°C of actual peak Temperature (t_p)		20 – 40 seconds
Ramp-down Rate		5°C/second max
Time 25°C to peak Temperature (T_P)		8 minutes Max.
Do not exceed		260°C

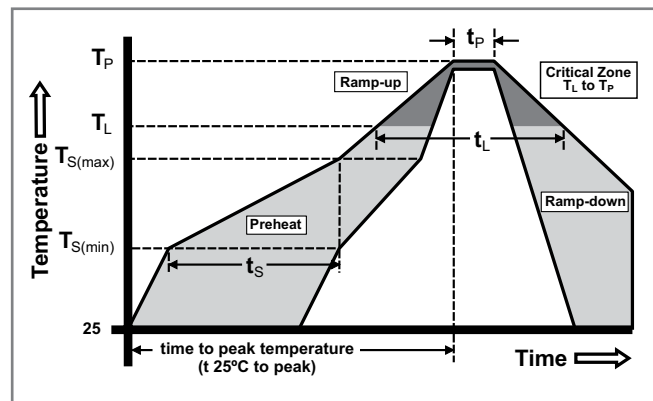

Wave Soldering	260°C, 10 seconds max.
----------------	------------------------

Surface Mount Fuses

Thin Film > 1206 Size > Slo-Blo® Fuse > 468 Series

Product Characteristics

Materials	Body: Epoxy Substrate Terminations: 100% Tin over Nickel over Copper Element Cover Coat: Conformal Coating
Operating Temperature	-55°C to 90°C. Consult temperature re-rating curve chart. For operation above 90°C please contact Littelfuse
Thermal Shock	Withstands 5 cycles of - 50°C to 125°C
Humidity	MIL-STD-202, Method 103, Condition D

Vibration	Withstands 10-55 Hz per MIL-STD-202, Method 201 and 10-2000 Hz at 20 g's per MIL-STD-202, Method 204, Condition D
Insulation Resistance (After Opening)	Greater than 10,000 ohms.
Resistance to Soldering Heat	MIL-STD-202, Method 210, Condition D

Dimensions

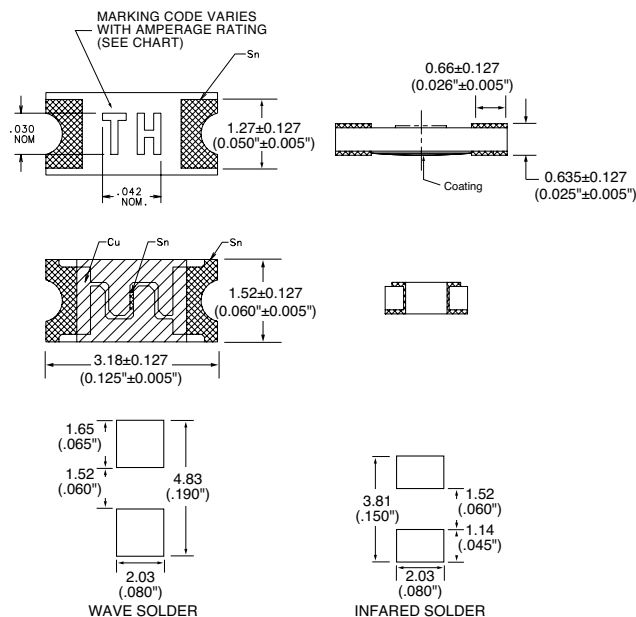

Part Marking System

Amp Code	Marking Code
.500	TF
001.	TH
01.5	TK
002.	TN
02.5	TO
003.	TP

Part Numbering System

0468002.NRHF

SERIES

AMP Code

The dot is positioned before the Packaging Suffix with whole ratings and within the numbering sequence for fractional ratings. Refer to Amp Code column in the Electrical Specifications table.

PACKAGING Code

NR = Tape and Reel, 5000 pcs

'HF' SUFFIX

HALOGEN FREE ITEM

Example:
1.5 amp product is 0468**01.5**NRHF (2 amp product shown above).



Packaging

Packaging Option	Packaging Specification	Quantity	Quantity & Packaging Code
Tape & Reel – 8mm tape	EIA-481 Rev. D (IEC 60286, part 3)	5000	NR

Disclaimer Notice - Littelfuse products are not designed for, and shall not be used for, any purpose (including, without limitation, automotive, military, aerospace, medical, life-saving, life-sustaining or nuclear facility applications, devices intended for surgical implant into the body, or any other application in which the failure or lack of desired operation of the product may result in personal injury, death, or property damage) other than those expressly set forth in applicable Littelfuse product documentation. Warranties granted by Littelfuse shall be deemed void for products used for any purpose not expressly set forth in applicable Littelfuse documentation. Littelfuse shall not be liable for any claims or damages arising out of products used in applications not expressly intended by Littelfuse as set forth in applicable Littelfuse documentation. The sale and use of Littelfuse products is subject to Littelfuse Terms and Conditions of Sale, unless otherwise agreed by Littelfuse. Information furnished is believed to be accurate and reliable. However, users should independently evaluate the suitability of and test each product selected for their own applications. Littelfuse products are not designed for, and may not be used in, all applications. Read complete Disclaimer Notice at www.littelfuse.com/disclaimer-electronics.

Looking for pricing, stock, or lifecycle information?

Click below to explore more details on WIN SOURCE:

-  [View 046801.5NR on WIN SOURCE](#)
-  [Littelfuse Inc. Information](#)

Optimize Your Supply Chain with WIN SOURCE Solutions

-  Global Sourcing Solution
-  Obsolete Management
-  Cost Control Management
-  Shortage Management
-  Alternative Solution
-  Excess Inventory Management