

Agilent HLMP-CWxx T-1 $\frac{3}{4}$ (5mm) Extra Bright Precision Optical Performance White LED Lamps Data Sheet

**HLMP-CW11, HLMP-CW12, HLMP-CW26, HLMP-CW27,
HLMP-CW36, HLMP-CW37**

Description

These high intensity white LED lamps are based on InGaN material technology. A blue LED die is coated by phosphor to produce white. The typical resulting color is described by the coordinates $x = 0.31$, $y = 0.31$ using the 1931 CIE Chromaticity Diagram.

These T-1 $\frac{3}{4}$ lamps are untinted, non-diffused, and incorporate precise optics which produce well-defined spatial radiation patterns at specific viewing cone angle.

Features

- Well defined spatial radiation pattern
- High luminous white emission
- Viewing angle: 15°, 23° and 30°
- Standoff or non-standoff leads
- Superior resistance to moisture

Applications

- Electronic signs and signals
- Small area illumination
- Legend backlighting
- General purpose indicators

Benefit

- Reduced power consumption, higher reliability, and increased optical/mechanical design flexibility compared to incandescent bulbs and other alternative white light sources.

Caution: Devices are Class 1 ESD sensitive. Please observe appropriate precautions during handling and processing. Refer to Application Note AN-1142 for additional details.



Agilent Technologies

Package Dimensions

Package Dimension A

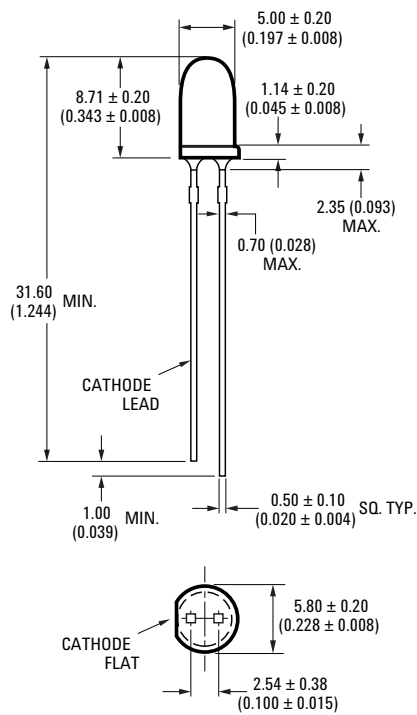

Package Dimension B

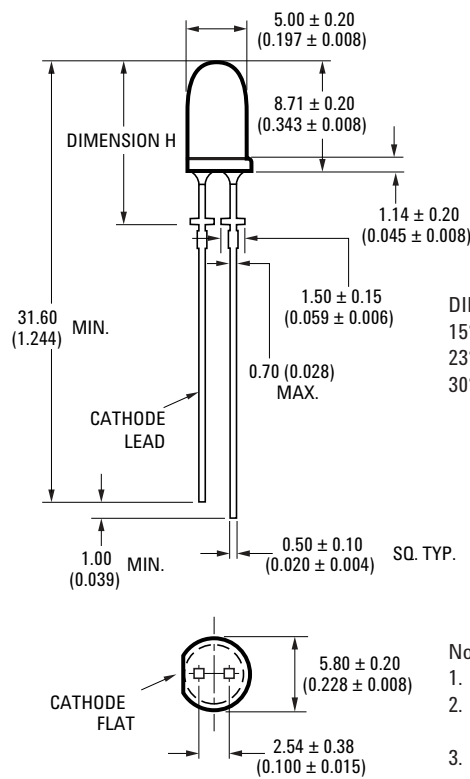

DIMENSION H:
 15°: 12.24 ± 0.25 mm (0.482 ± 0.01 inches)
 23°: 12.50 ± 0.25 mm (0.492 ± 0.01 inches)
 30°: 12.00 ± 0.25 mm (0.472 ± 0.01 inches)

Notes:

1. All dimensions are in millimeters / inches.
2. Epoxy meniscus may extend about 1mm (0.040") down the leads.
3. If heat-sinking application is required, the terminal for heat sink is anode.

Part Numbering System

H L M P - CW XX - X X X XX

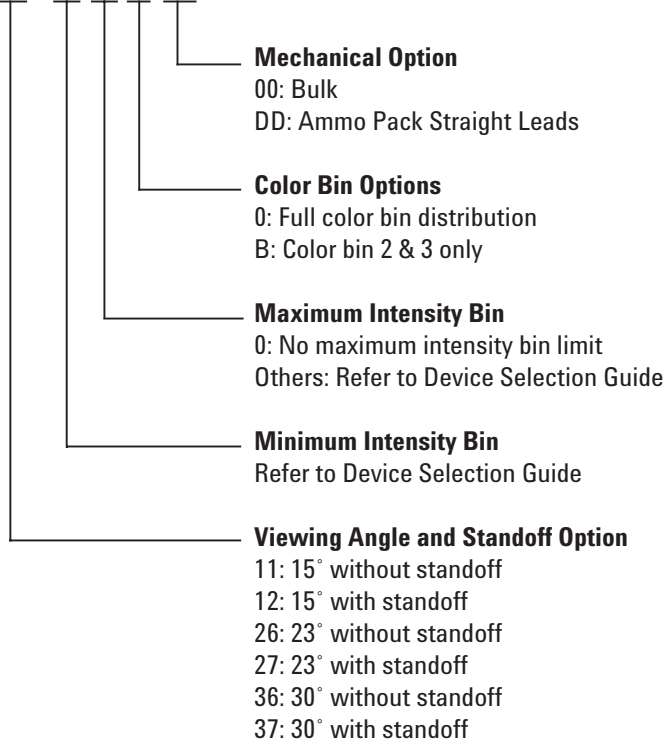

Device Selection Guide

Part Number	Typical Viewing Angle, $2\theta_{1/2}$ (Degree)	Intensity (mcd) at 20 mA		Standoff	Package Dimension
		Min.	Max.		
HLMP-CW11-WZ0xx	15	5500	16000	No	A
HLMP-CW11-X10xx	15	7200	21000	No	A
HLMP-CW11-XY0xx	15	7200	12000	No	A
HLMP-CW11-YZ0xx	15	9300	16000	No	A
HLMP-CW12-WZ0xx	15	5500	16000	Yes	B
HLMP-CW12-X10xx	15	7200	21000	Yes	B
HLMP-CW12-XY0xx	15	7200	12000	Yes	B
HLMP-CW12-XYBxx	15	7200	12000	Yes	B
HLMP-CW12-YZ0xx	15	9300	16000	Yes	B
HLMP-CW12-YZBxx	15	9300	16000	Yes	B
HLMP-CW26-UX0xx	23	3200	9300	No	A
HLMP-CW26-VW0xx	23	4200	7200	No	A
HLMP-CW26-VY0xx	23	4200	12000	No	A
HLMP-CW26-WX0xx	23	5500	9300	No	A
HLMP-CW27-UX0xx	23	3200	9300	Yes	B
HLMP-CW27-UX2xx	23	3200	9300	Yes	B
HLMP-CW27-VW0xx	23	4200	7200	Yes	B
HLMP-CW27-VY0xx	23	4200	12000	Yes	B
HLMP-CW27-WX0xx	23	5500	9300	Yes	B
HLMP-CW36-TW0xx	30	2500	7200	No	A
HLMP-CW36-UV0xx	30	3200	5500	No	A
HLMP-CW36-UVBxx	30	3200	5500	No	A
HLMP-CW36-VW0xx	30	4200	7200	No	A
HLMP-CW36-VWBxx	30	4200	7200	No	A
HLMP-CW37-TW0xx	30	2500	7200	Yes	B
HLMP-CW37-UV0xx	30	3200	5500	Yes	B
HLMP-CW37-UVBxx	30	3200	5500	Yes	B
HLMP-CW37-VW0xx	30	4200	7200	Yes	B
HLMP-CW37-VWBxx	30	4200	7200	Yes	B

Notes:

1. Tolerance for luminous intensity measurement is +/- 15%
2. The luminous intensity is measured on the mechanical axis of the lamp package.
3. The optical axis is closely aligned with the package mechanical axis.
4. LED light output is bright enough to cause injuries to the eyes. Precautions must be taken to prevent looking directly at the LED without proper safety equipment.
5. $2\theta_{1/2}$ is the off-axis angle where the luminous intensity is $\frac{1}{2}$ the on axis intensity.
6. Part numbers in **BOLD** are recommended for new designs.

Absolute Maximum Rating at $T_A = 25^\circ\text{C}$

Parameters	Value	Unit
DC forward current ^[1]	30	mA
Peak pulsed forward current ^[2]	100	mA
Power dissipation	105	mW
LED junction temperature	110	$^\circ\text{C}$
Operating temperature range	-40 to +85	$^\circ\text{C}$
Storage temperature range	-40 to +100	$^\circ\text{C}$

Notes:

- Derate linearly as shown in figure 2.
- Duty factor 10%, frequency 1KHz

Electrical/Optical Characteristics $T_A = 25^\circ\text{C}$

Parameters	Symbol	Min	Typ	Max	Units	Test Condition
Forward voltage	V_F		3.2	4.0	V	$I_F = 20 \text{ mA}$
Reverse Voltage ^[1]	V_R	5.0			V	$I_R = 10 \mu\text{A}$
Thermal resistance	$R_{\theta_{J-PIN}}$		240		$^\circ\text{C}/\text{W}$	LED Junction to anode lead
Chromaticity Coordinates ^[2]	X		0.31			$I_F = 20 \text{ mA}$
	Y		0.31			
Capacitance	C		70			$V_f=0, f=1\text{MHz}$

Notes:

- The reverse voltage of the product is equivalent to the forward voltage of the protective chip at $I_R = 10 \mu\text{A}$
- The chromaticity coordinates are derived from the CIE 1931 Chromaticity Diagram and represent the perceived color of the device.

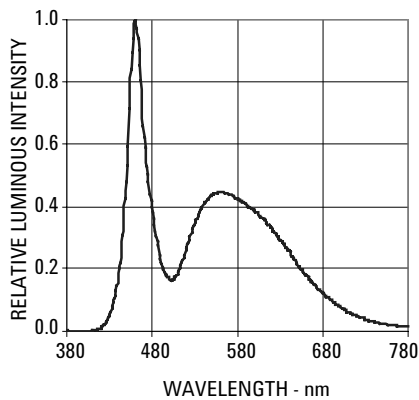

Figure 1. Relative Intensity vs. Wavelength

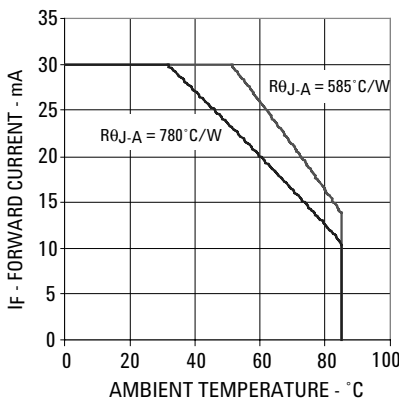

Figure 2. Forward Current vs. Ambient Temperature

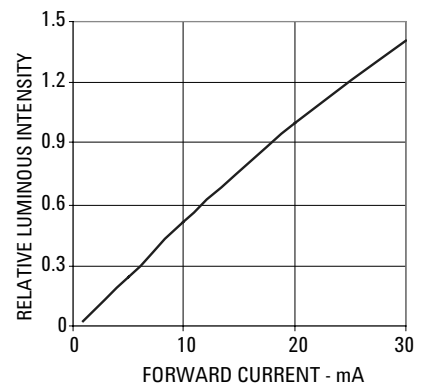

Figure 3. Relative Intensity versus DC Forward Current

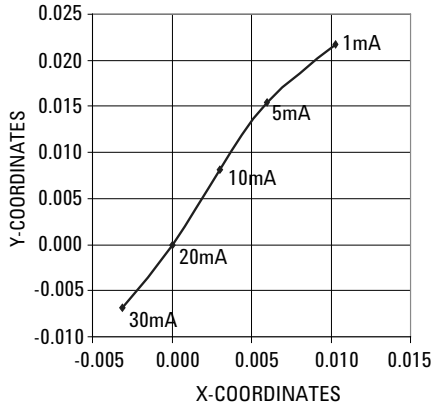

Figure 4. Chromaticity shift vs. Current

*Note: (x,y) values @ 20mA reference to (0,0)

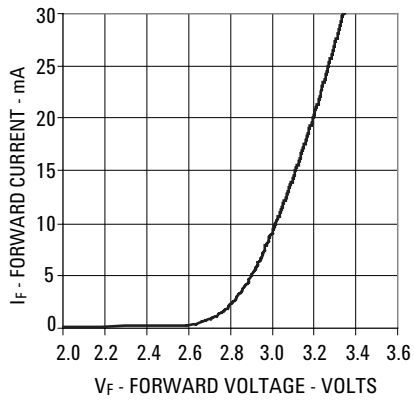

Figure 5. Forward Current vs. Forward Voltage

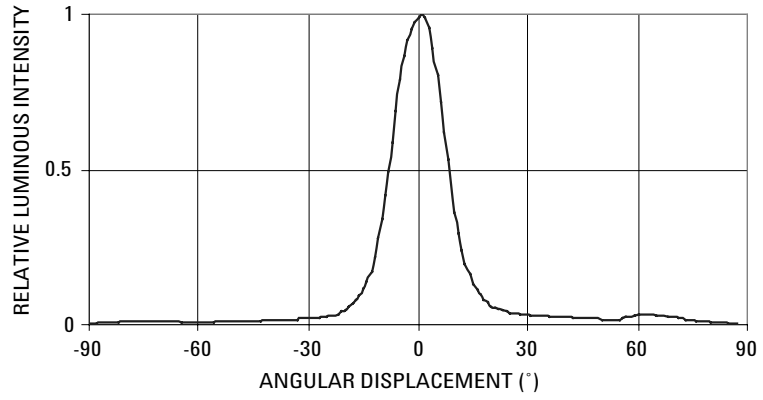

Figure 6. Spatial Radiation Pattern for CW1x

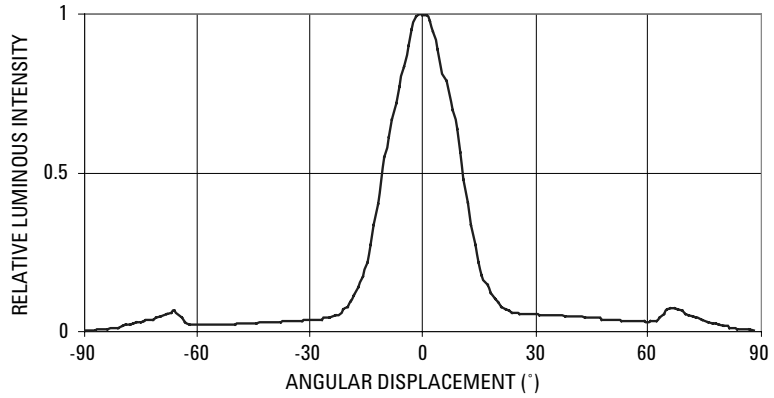

Figure 7. Spatial Radiation Pattern for CW2x

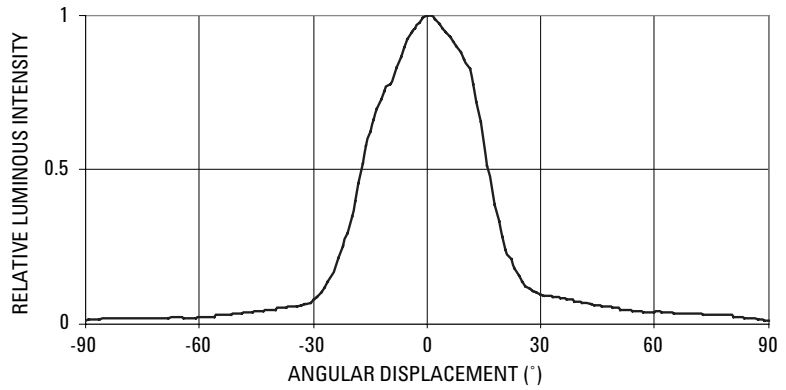

Figure 8. Spatial Radiation Pattern for CW3x

Intensity Bin Limit Table

Bin	Intensity (mcd) at 20 mA	
	Min	Max
Q	1150	1500
R	1500	1900
S	1900	2500
T	2500	3200
U	3200	4200
V	4200	5500
W	5500	7200
X	7200	9300
Y	9300	12000
Z	12000	16000
1	16000	21000

Tolerance for each bin limit is $\pm 15\%$

Color Bin Limit Table

Rank	Limits (Chromaticity Coordinates)					
1	X	0.330	0.330	0.356	0.361	
	Y	0.360	0.318	0.351	0.385	
2	X	0.287	0.296	0.330	0.330	
	Y	0.295	0.276	0.318	0.339	
3	X	0.264	0.280	0.296	0.283	
	Y	0.267	0.248	0.276	0.305	
4	X	0.283	0.287	0.330	0.330	
	Y	0.305	0.295	0.339	0.360	

Tolerance for each bin limit is ± 0.01

Note:

1. Bin categories are established for classification of products. Products may not be available in all bin categories. Please contact your Agilent representative for information on currently available bins.

Color Bin Limits with Respect to CIE 1931 Chromaticity Diagram

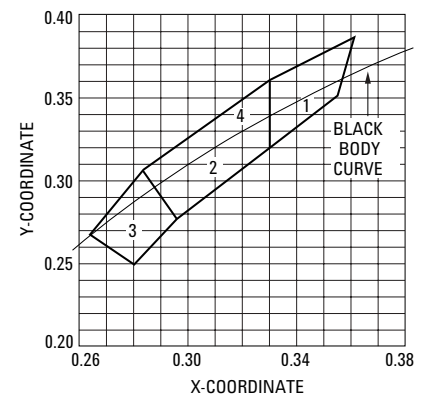

Precautions:

Lead Forming:

- The leads of an LED lamp may be preformed or cut to length prior to insertion and soldering into PC board.
- If lead forming is required before soldering, care must be taken to avoid any excessive mechanical stress induced to LED package. Otherwise, cut the leads of LED to length after soldering process at room temperature. The solder joint formed will absorb the mechanical stress of the lead cutting from traveling to the LED chip die attach and wirebond.
- It is recommended that tooling made to precisely form and cut the leads to length rather than rely upon hand operation.

Soldering Condition:

- Care must be taken during PCB assembly and soldering process to prevent damage to LED component.
- The closest LED is allowed to solder on board is 1.59mm below the body (encapsulant epoxy) for those parts without standoff.
- Recommended soldering condition:

	Wave Soldering	Manual Solder Dipping
Pre-heat temperature	105 °C Max.	–
Preheat time	30 sec Max	–
Peak temperature	250 °C Max.	260 °C Max.
Dwell time	3 sec Max.	5 sec Max

- Wave soldering parameter must be set and maintain according to recommended temperature and dwell time in the solder wave. Customer is advised to periodically check on the soldering profile to ensure the soldering profile used is always conforming to recommended soldering condition.
- If necessary, use fixture to hold the LED component in proper orientation with respect to the PCB during soldering process.
- Proper handling is imperative to avoid excessive thermal stresses to LED components when heated. Therefore, the soldered PCB must be allowed to cool to room temperature, 25°C before handling.
- Special attention must be given to board fabrication, solder masking, surface plating and lead holes size and component orientation to assure solderability.
- Recommended PC board plated through holes size for LED component leads.

LED component lead size	Diagonal	Plated through hole diameter
0.457 x 0.457mm (0.018 x 0.018inch)	0.646 mm (0.025 inch)	0.976 to 1.078 mm (0.038 to 0.042 inch)
0.508 x 0.508mm (0.020 x 0.020inch)	0.718 mm (0.028 inch)	1.049 to 1.150mm (0.041 to 0.045 inch)

Note: Refer to application note AN1027 for more information on soldering LED components.

Recommended Wave Soldering Profile

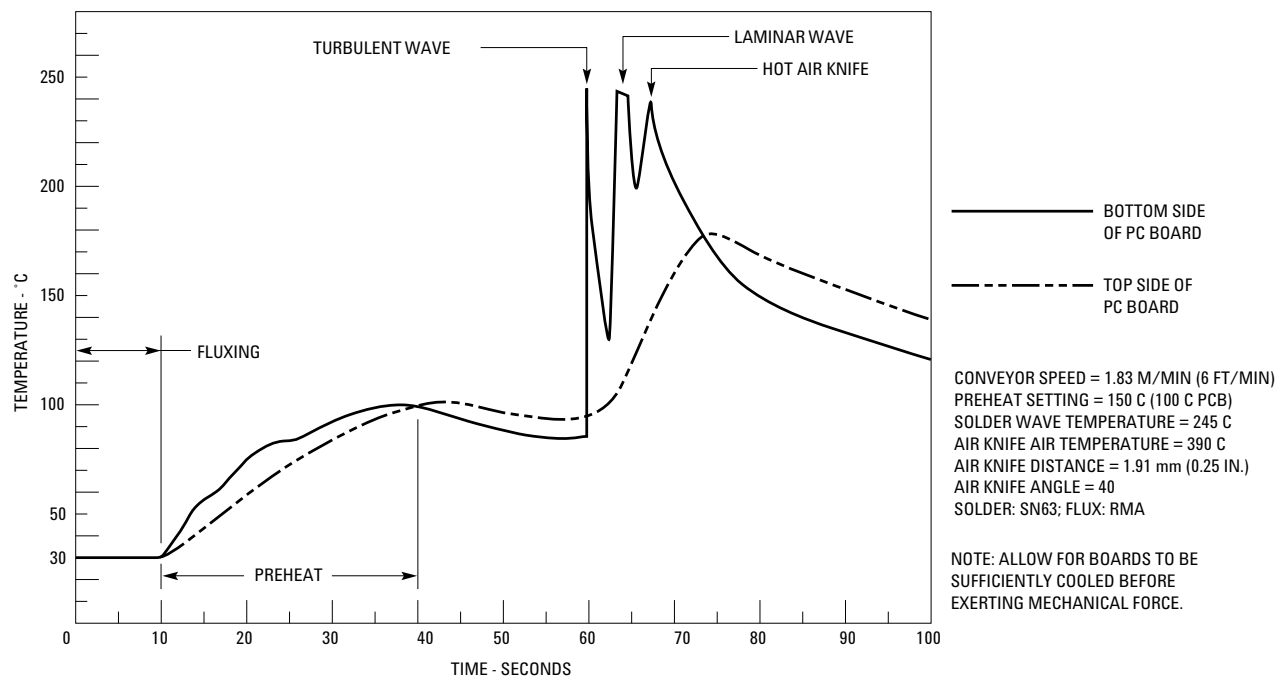

**[www.agilent.com/
semiconductors](http://www.agilent.com/semiconductors)**

For product information and a complete list of distributors, please go to our web site.

For technical assistance call:

Americas/Canada: +1 (800) 235-0312
or (408) 654-8675

Europe: +49 (0) 6441 92460

China: 10800 650 0017

Hong Kong: (+65) 6756 2394

India, Australia, New Zealand: (+65) 6755 1939

Japan: (+81 3) 3335-8152(Domestic/International), or 0120-61-1280(Domestic Only)

Korea: (+65) 6755 1989

Singapore, Malaysia, Vietnam, Thailand, Philippines, Indonesia: (+65) 6755 2044

Taiwan: (+65) 6755 1843

Data subject to change.

Copyright © 2004-2005 Agilent Technologies, Inc.

Obsoletes 5989-3733EN

October 20, 2005



5989-4117EN



Agilent Technologies

Looking for pricing, stock, or lifecycle information?

Click below to explore more details on WIN SOURCE:

-  [View HLMP-CW11-XY000 on WIN SOURCE](#)
-  [Broadcom Limited Information](#)

Optimize Your Supply Chain with WIN SOURCE Solutions

-  Global Sourcing Solution
-  Obsolete Management
-  Cost Control Management
-  Shortage Management
-  Alternative Solution
-  Excess Inventory Management