

2ch High Side Switch ICs

Current Limit High Side Switch ICs

BD6516F BD6517F BD2042AFJ BD2052AFJ

General Description

BD6516F, BD6517F, BD2042AFJ and BD2052AFJ are dual channel high side switch ICs with an over current protection for Universal Serial Bus (USB) power supply line. The IC's switch unit has two channels of N-Channel power MOSFET. Over current detection circuit, thermal shutdown circuit, under voltage lockout and soft start circuit are built in.

Features

- Dual N-MOS High Side Switch
- Control Input Logic
 - Active-Low: BD6517F, BD2042AFJ
 - Active-High: BD6516F, BD2052AFJ
- Soft Start Circuit
- Over Current Detection
- Thermal Shutdown
- Under Voltage Lockout
- Open Drain Error Flag Output
- Reverse-Current Protection when Switch Off
- Flag Output Delay

Applications

USB Hub in Consumer Appliances, Note PC, PC Peripheral Equipment, and so on.

Typical Application Circuit

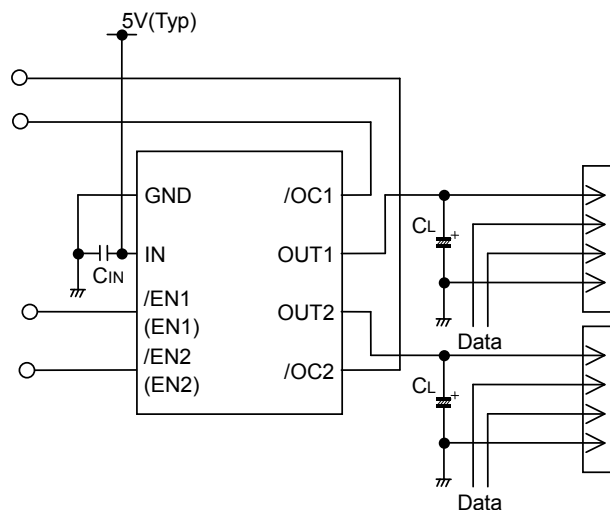

Key Specifications

- Input Voltage Range:
 - BD6516F/BD6517F 3.0V to 5.5V
 - BD2042AFJ/BD2052AFJ 2.7V to 5.5V
- ON-Resistance:
 - BD6516F/BD6517F 110mΩ(Typ)
 - BD2042AFJ/BD2052AFJ 100mΩ(Typ)
- Continuous Current: 0.5A
- Current Limit Threshold:
 - BD6516F/BD6517F 1.2A(Min), 2.5A (Max)
 - BD2042AFJ/BD2052AFJ 0.7A(Min), 1.8A (Max)
- Standby Current: 0.01μA (Typ)
- Output Rise Time: 1.8ms (Typ)
- Operating Temperature Range:
 - BD6516F/BD6517F -25°C to +85°C
 - BD2042AFJ/BD2052AFJ -40°C to +85°C

Packages

W(Typ) D(Typ) H(Max)

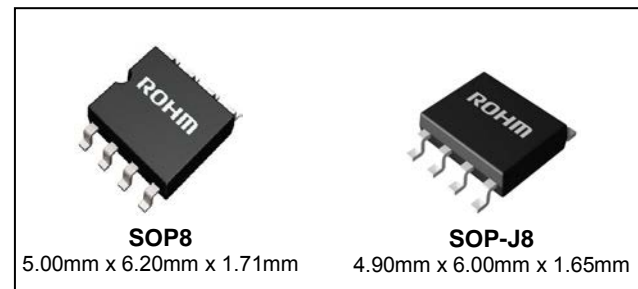

Lineup

Current Limit Threshold			Control Input Logic	Package	Orderable Part Number
Min	Typ	Max			
1.2A	1.65A	2.5A	High	SOP8	BD6516F-E2
1.2A	1.65A	2.5A	Low		BD6517F-E2
0.7A	1.0A	1.8A	High	SOP-J8	BD2052AFJ-E2
0.7A	1.0A	1.8A	Low		BD2042AFJ-E2

○Product structure : Silicon monolithic integrated circuit ○This product has not designed protection against radioactive rays

Block Diagrams

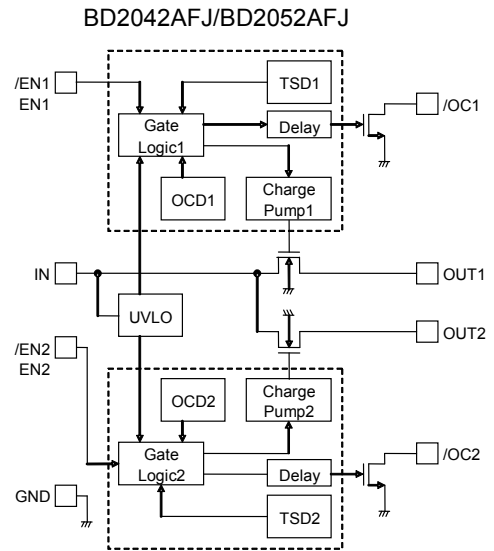
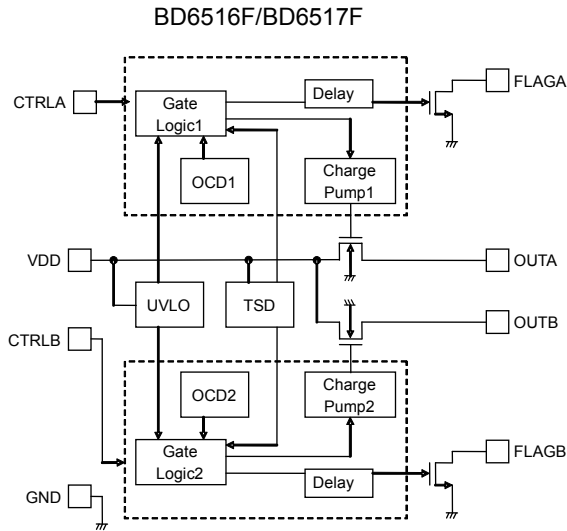

Pin Configurations

BD6516F/BD6517F TOP VIEW

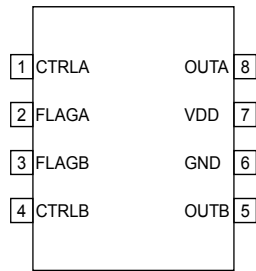

BD2042AFJ/BD2052AFJ TOP VIEW

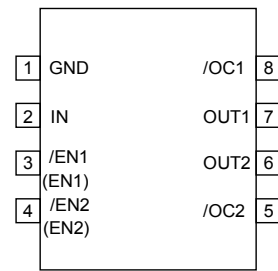

Pin Descriptions

BD6516F/BD6517F

Pin No.	Symbol	I / O	Pin Function
1, 4	CTRLA CTRLB	I	Enable input. Switch on at low level. (BD6517F) Low level input < 0.7V. Switch on at high level. (BD6516F) High level input > 2.5V.
2, 3	FLAGA FLAGB	O	Error flag output. Low at over current, thermal shutdown. Open drain output.
5, 8	OUTA OUTB	O	Switch output.
6	GND	I	Ground.
7	VDD	I	Power supply input. Input terminal of the switch and power supply of internal circuit.

BD2042AFJ/BD2052AFJ

Pin No.	Symbol	I / O	Pin Function
1	GND	I	Ground.
2	IN	I	Power supply input. Input terminal of the switch and power supply of internal circuit.
3, 4	/EN1 /EN2, EN1 EN2	I	Enable input. /EN: Switch on at low level. (BD2042AFJ) Low level input < 0.8V EN: Switch on at high level. (BD2052AFJ) High level input > 2.0V.
5, 8	/OC2 /OC1	O	Error flag output. Low at over current, thermal shutdown. Open drain output.
6, 7	OUT2 OUT1	O	Switch output.

Absolute Maximum Ratings

BD6516F/BD6517F

Parameter	Symbol	Rating	Unit
Input Voltage	V _{DD}	-0.3 to +6.0	V
CTRL Voltage	V _{CTRL}	-0.3 to V _{DD} +0.3	V
FLAG Voltage	V _{FLAG}	-0.3 to +6.0	V
Output Voltage	V _{OUT}	-0.3 to +6.0	V
Storage Temperature	T _{stg}	-55 to +150	°C
Power Dissipation	P _d	0.67 ^(Note 1)	W

BD2042AFJ/BD2052AFJ

Parameter	Symbol	Rating	Unit
Input Voltage	V _{IN}	-0.3 to +6.0	V
EN, /EN Voltage	V _{EN} , V _{/EN}	-0.3 to +6.0	V
/OC Voltage	V _{/OC}	-0.3 to +6.0	V
/OC Current	I _{S/OC}	10	mA
OUT Voltage	V _{OUT}	-0.3 to +6.0	V
Storage Temperature	T _{stg}	-55 to +150	°C
Power Dissipation	P _d	0.67 ^(Note 1)	W

(Note 1) Mounted on 70mm x 70mm x 1.6mm glass-epoxy PCB. Derating : 5.4mW/°C above Ta=25°C

Caution: Operating the IC over the absolute maximum ratings may damage the IC. The damage can either be a short circuit between pins or an open circuit between pins and the internal circuitry. Therefore, it is important to consider circuit protection measures, such as adding a fuse, in case the IC is operated over the absolute maximum ratings.

Recommended Operation Conditions

BD6516F/BD6517F

Parameter	Symbol	Rating			Unit
		Min	Typ	Max	
Input Voltage	V _{DD}	3.0	-	5.5	V
Operation Temperature	T _{opr}	-25	-	+85	°C
Continuous Output Current	I _{LO}	0	-	500	mA

BD2042AFJ/BD2052AFJ

Parameter	Symbol	Rating			Unit
		Min	Typ	Max	
Input Voltage	V _{IN}	2.7	-	5.5	V
Operation Temperature	T _{opr}	-40	-	+85	°C
Continuous Output Current	I _{LO}	0	-	500	mA

Electrical Characteristics

BD6516F/BD6517F ($V_{DD}=5V$, $T_a=25^\circ C$, unless otherwise specified.)

Parameter	Symbol	Limit			Unit	Conditions
		Min	Typ	Max		
Operating Current	I_{DD}	-	100	140	μA	$V_{CTRL}=5V$ (BD6516F), $0V$ (BD6517F) OUT=OPEN
Standby Current	I_{STB}	-	0.01	2	μA	$V_{CTRL}=0V$ (BD6516F), $5V$ (BD6517F) OUT=OPEN
CTRL Input Voltage	V_{CTRL}	-	-	0.7	V	Low Level Input Voltage
		2.5	-	-	V	High Level Input Voltage
CTRL Input Current	I_{CTRL}	-1	+0.01	+1	μA	$V_{CTRL}=0V$ or $5V$
FLAG Output Resistance	R_{FLAG}	-	250	450	Ω	$I_{FLAG}=1mA$
FLAG Output Leak Current	I_{FLAG}	-	0.01	1	μA	$V_{FLAG}=5V$
FLAG Output Delay	t_{FL}	-	1	4	ms	
ON-Resistance	R_{ON}	-	110	150	m Ω	$V_{DD}=5V$, $I_{OUT}=500mA$
		-	140	180	m Ω	$V_{DD}=3.3V$, $I_{OUT}=500mA$
Over-Current Threshold	I_{TH}	1.2	1.65	2.5	A	
Short Circuit Output Current	I_{SC}	1.2	1.65	2.2	A	$V_{OUT}=0V$
Output Leak Current	I_{LEAK}	-	-	10	μA	$V_{CTRL}=0V$ (BD6516F), $5V$ (BD6517F)
Thermal Shutdown Threshold	T_{TS}	-	135	-	$^\circ C$	At T_j Increase
Output Rise Time	t_{ON1}	0.1	1.3	4.0	ms	$R_L=10\Omega$
Output Turn ON Delay Time	t_{ON2}	0.2	1.5	6.0	ms	$R_L=10\Omega$
Output Fall Time	t_{OFF1}	-	1	20	μs	$R_L=10\Omega$
Output Turn OFF Delay Time	t_{OFF2}	-	3	20	μs	$R_L=10\Omega$

BD2042AFJ/BD2052AFJ ($V_{DD}=5V$, $T_a=25^\circ C$, unless otherwise specified.)

Parameter	Symbol	Limit			Unit	Conditions
		Min	Typ	Max		
Operating Current	I_{DD}	-	110	140	μA	$V_{/EN} = 0V$, OUT = OPEN (BD2042AFJ) $V_{EN} = 5V$, OUT = OPEN (BD2052AFJ)
Standby Current	I_{STB}	-	0.01	1	μA	$V_{/EN} = 5V$, OUT = OPEN (BD2042AFJ) $V_{EN} = 0V$, OUT = OPEN (BD2052AFJ)
/EN, EN Input Voltage	$V_{/ENH}$, V_{ENH}	2.0	-	-	V	High Input
		-	-	0.8	V	Low Input
		-	-	0.4	V	Low Input $2.7V \leq V_{IN} \leq 4.5V$
/EN, EN Input Current	$I_{/EN}$, I_{EN}	-1.0	+0.01	+1.0	μA	$V_{/EN}, V_{EN} = 0V$ or $V_{/EN}, V_{EN} = 5V$
/OC Output Low Voltage	$V_{/OC}$	-	-	0.5	V	$I_{/OC} = 5mA$
/OC Output Leak Current	$I_{L/OC}$	-	0.01	1	μA	$V_{/OC} = 5V$
ON-Resistance	R_{ON}	-	100	130	m Ω	$I_{OUT} = 500mA$
Over-Current Threshold	I_{TH}	0.7	1.0	1.8	A	
Short Circuit Output Current	I_{SC}	0.7	1.0	1.3	A	$V_{IN} = 5V$, $V_{OUT} = 0V$, $C_L = 100\mu F$ (RMS)
Output Rise Time	t_{ON1}	-	1.8	10	ms	$R_L = 10\Omega$, $C_L = OPEN$
Output Turn ON Time	t_{ON2}	-	2.1	20	ms	
Output Fall Time	t_{OFF1}	-	1	20	μs	
Output Turn OFF Time	t_{OFF2}	-	3	40	μs	
UVLO Threshold	V_{TUVH}	2.1	2.3	2.5	V	Increasing V_{IN}
	V_{TUVL}	2.0	2.2	2.4	V	Decreasing V_{IN}

Measurement Circuits

BD6516F/BD6517F

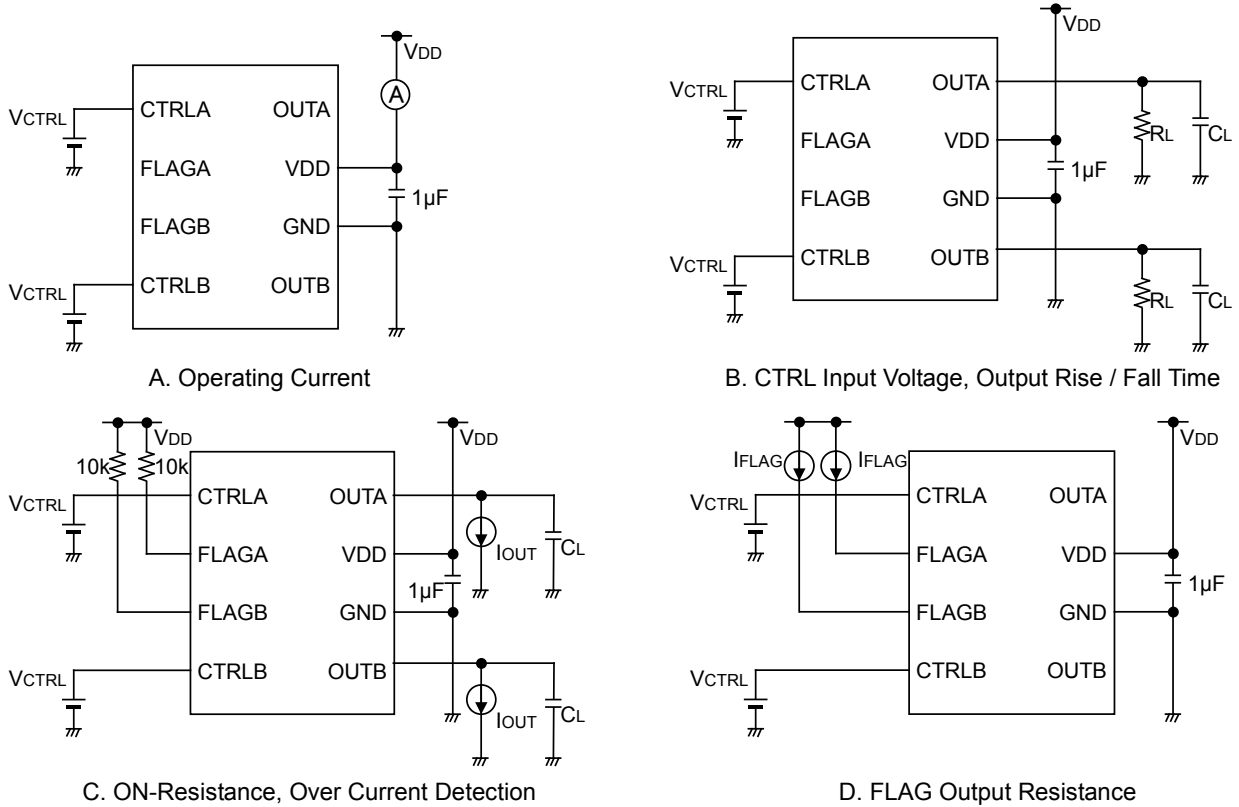

BD2042AFJ/BD2052AFJ

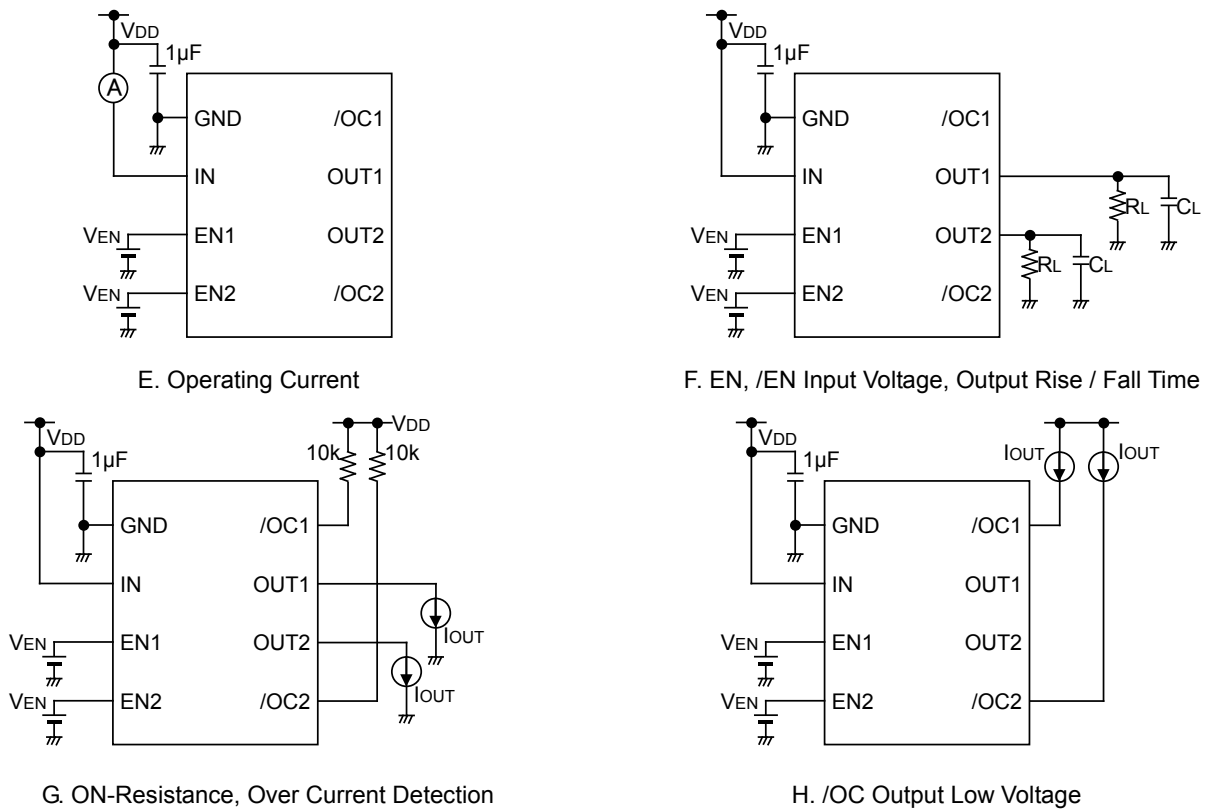

Figure 1. Measurement Circuits

Timing Diagram

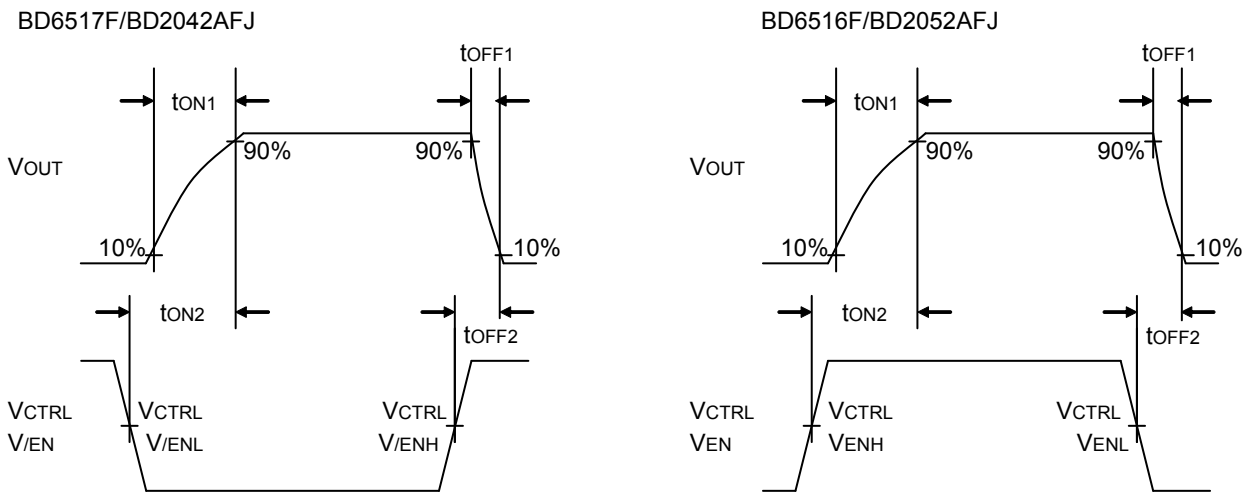

Figure 2. Timing Diagram

Typical Performance Curves

BD6516F/ BD6517F

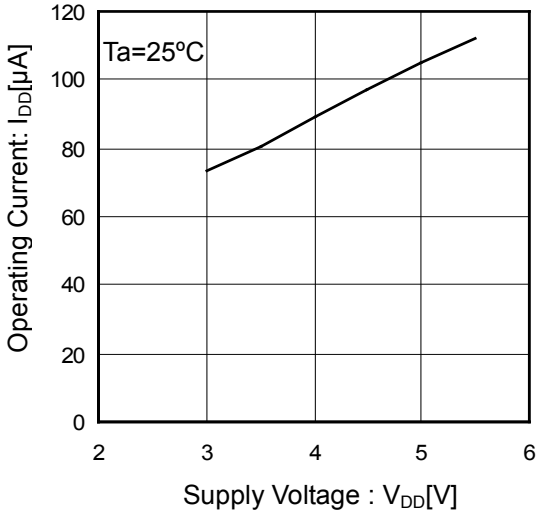

Figure 3. Operating Current vs Supply Voltage

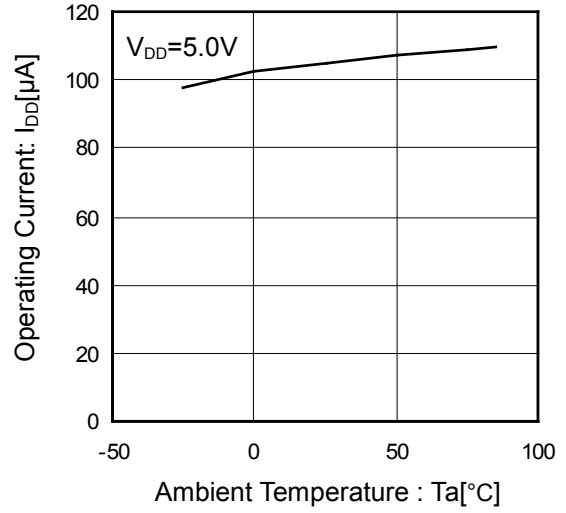

Figure 4. Operating Current vs Ambient Temperature

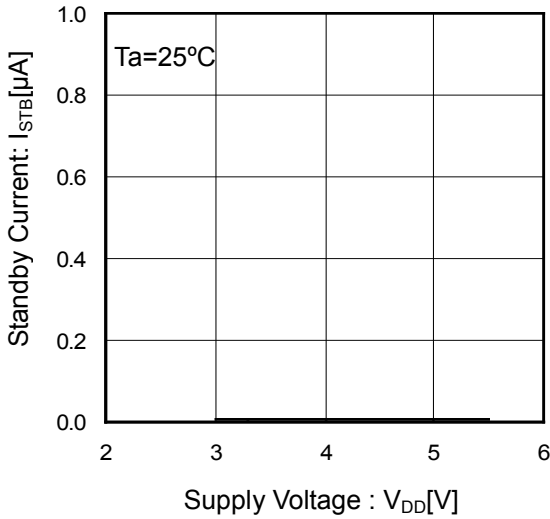

Figure 5. Standby Current vs Supply Voltage

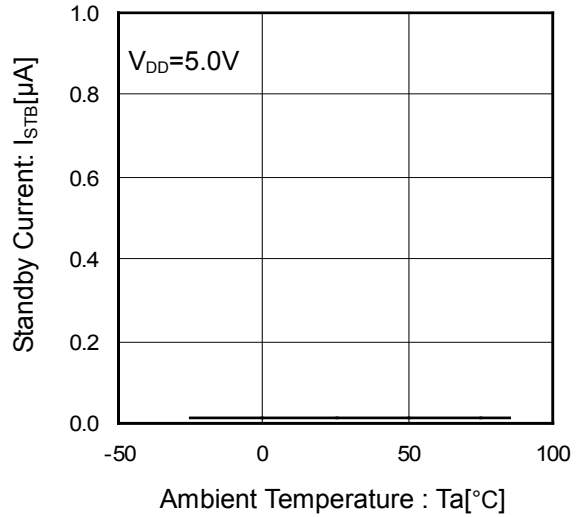

Figure 6. Standby Current vs Ambient Temperature

Typical Performance Curves - continued

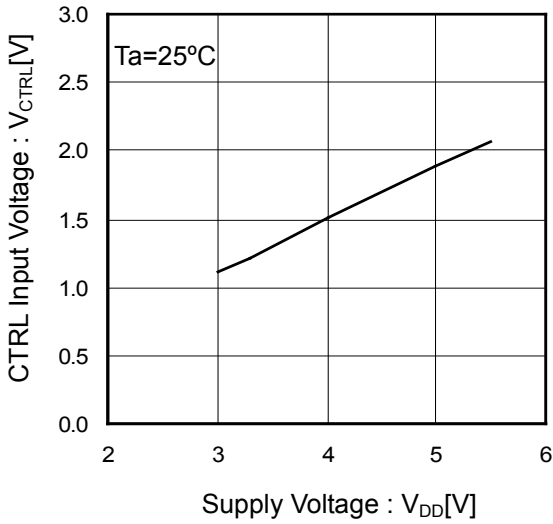

Figure 7. CTRL Input Voltage vs Supply Voltage (BD6516F)

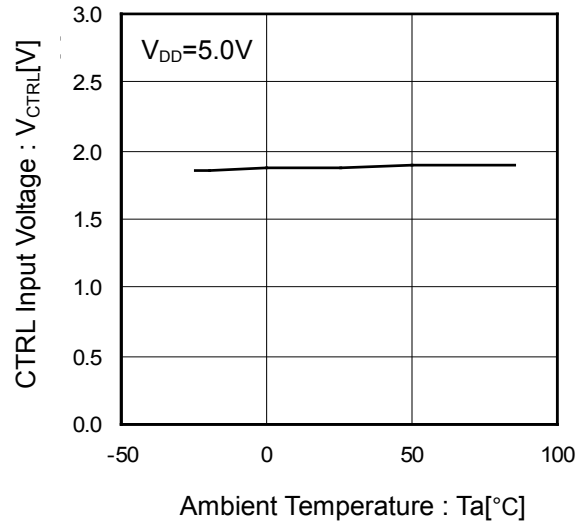

Figure 8. CTRL Input Voltage vs Ambient Temperature (BD6516F)

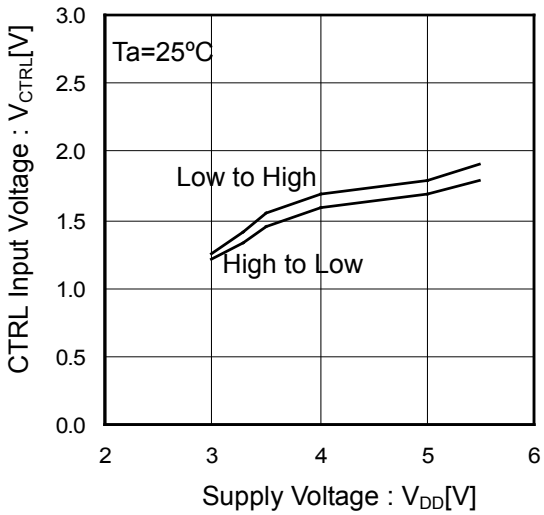

Figure 9. CTRL Input Voltage vs Supply Voltage (BD6517F)

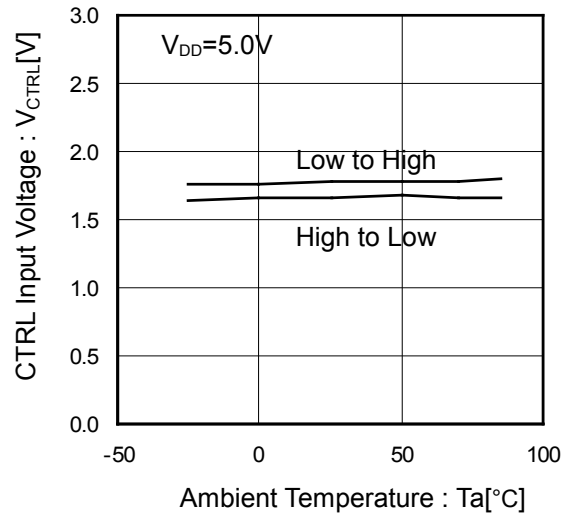

Figure 10. CTRL Input Voltage vs Ambient Temperature (BD6517F)

Typical Performance Curves - continued

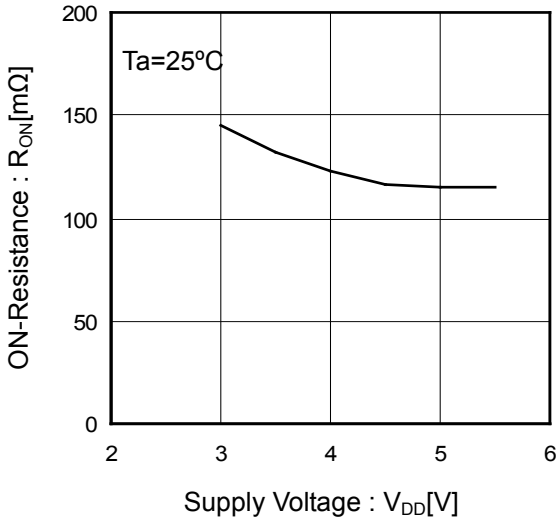

Figure 11. ON-Resistance vs Supply Voltage

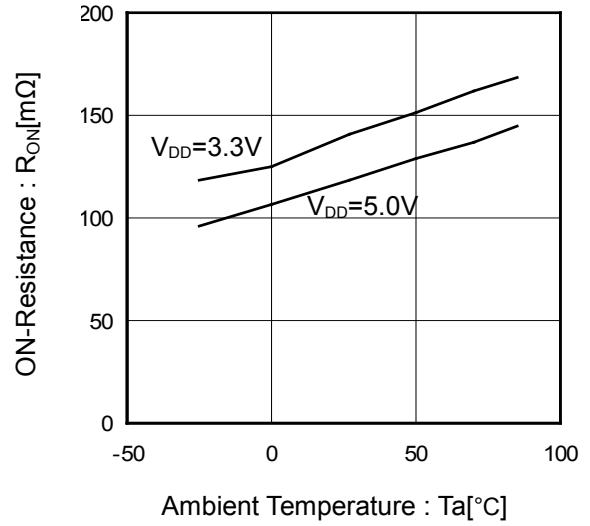

Figure 12. ON-Resistance vs Ambient Temperature

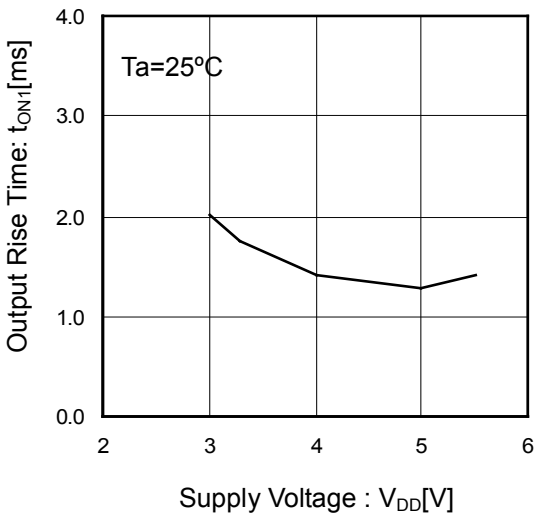

Figure 13. Output Rise Time vs Supply Voltage

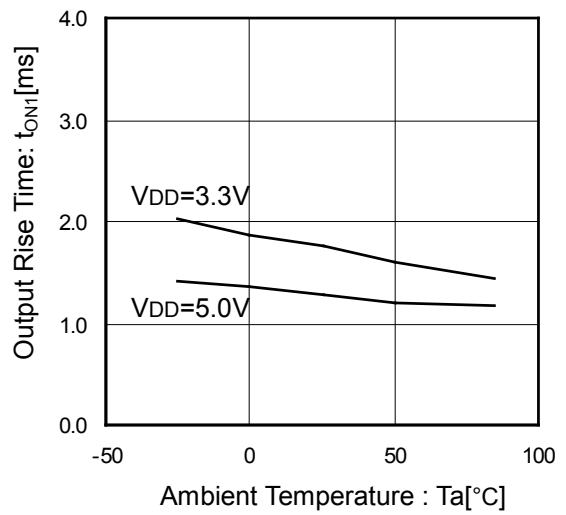

Figure 14. Output Rise Time vs Ambient Temperature

Typical Performance Curves - continued

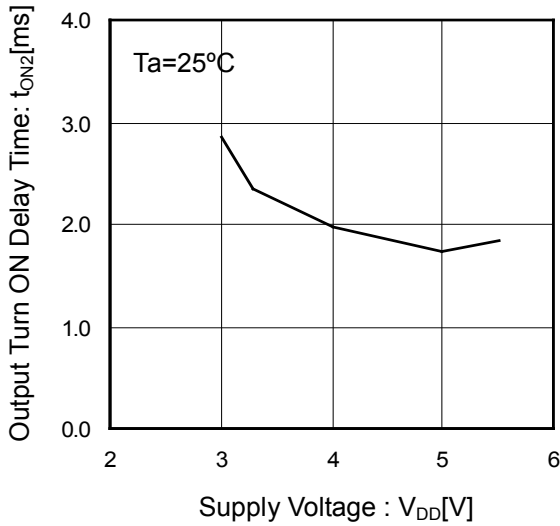

Figure 15. Output Turn ON Delay Time vs Supply Voltage

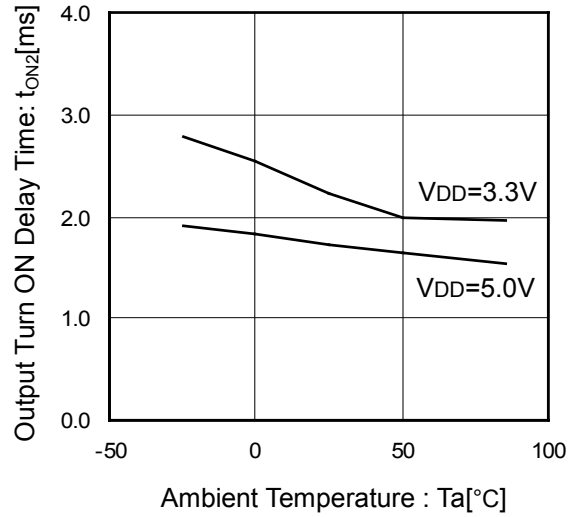

Figure 16. Output Turn ON Delay Time vs Ambient Temperature

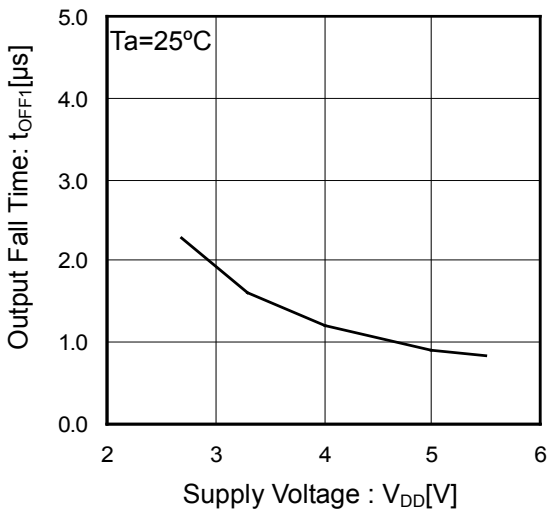

Figure 17. Output Fall Time vs Supply Voltage

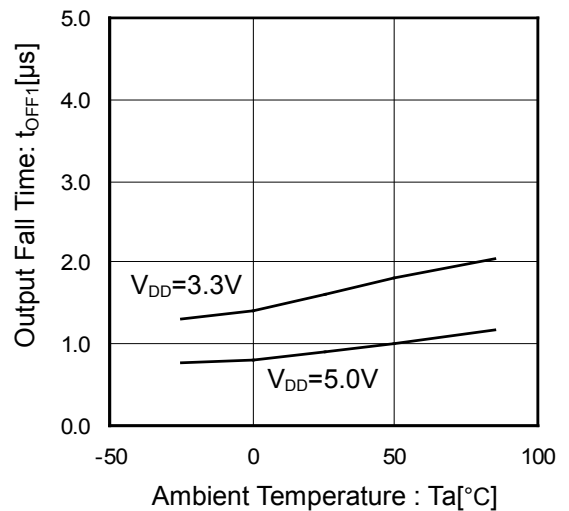

Figure 18. Output Fall Time vs Ambient Temperature

Typical Performance Curves - continued

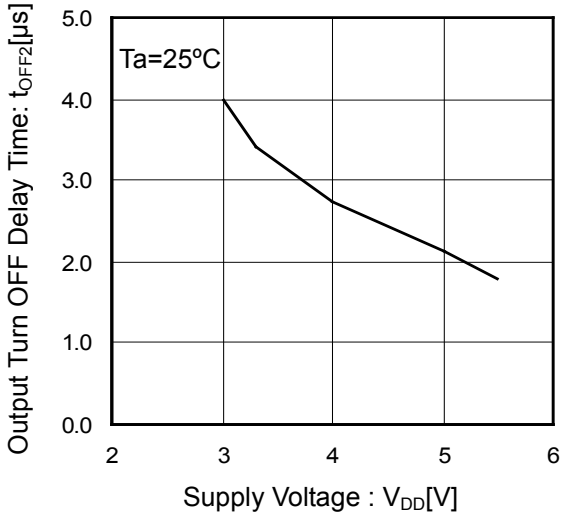

Figure 19. Output Turn OFF Delay Time vs Supply Voltage

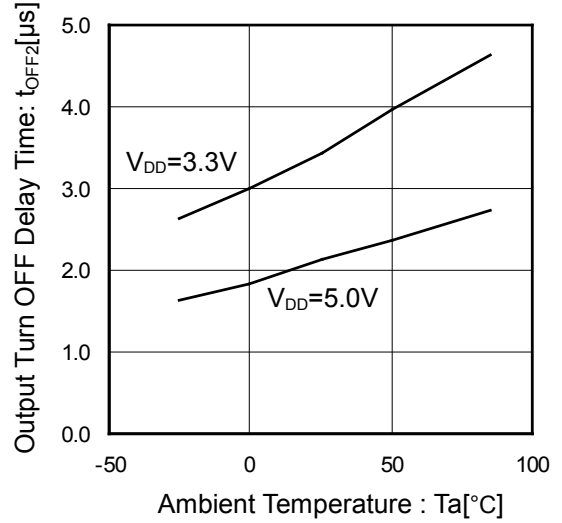

Figure 20. Output Turn OFF Delay Time vs Ambient Temperature

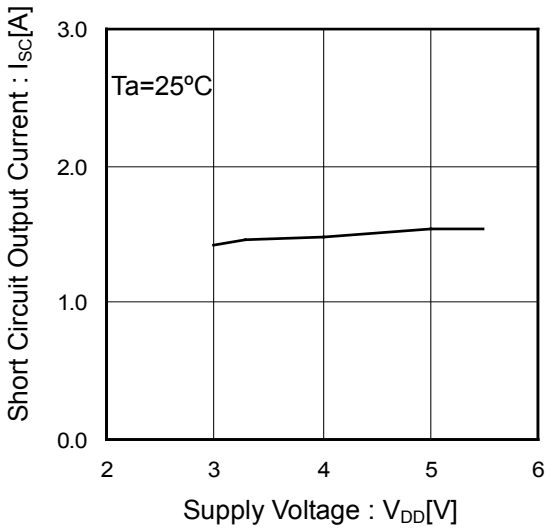

Figure 21. Short Circuit Output Current vs Supply Voltage

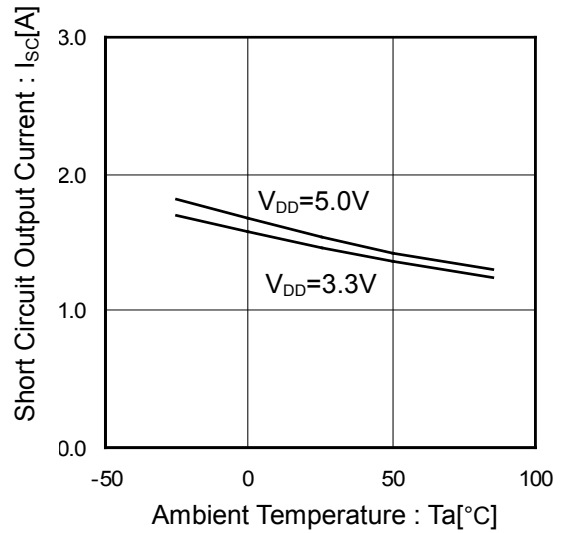

Figure 22. Short Circuit Output Current vs Ambient Temperature

Typical Performance Curves - continued

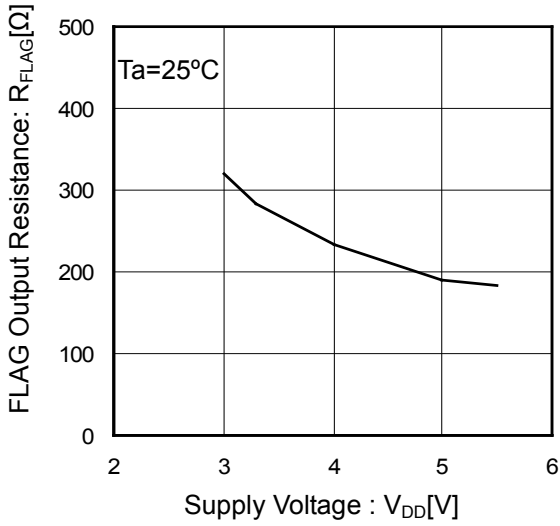

Figure 23. FLAG Output Resistance vs Supply Voltage

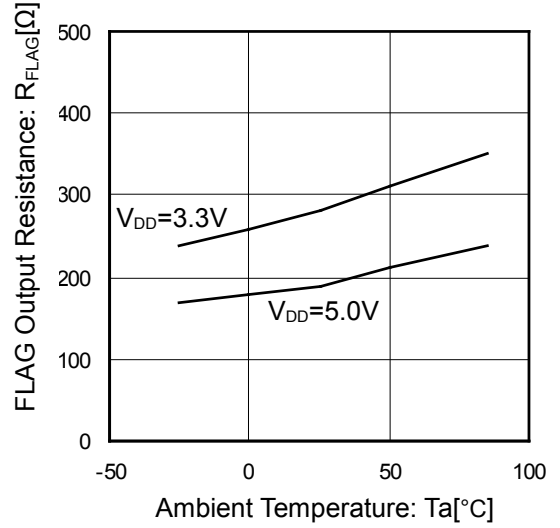

Figure 24. FLAG Output Resistance vs Ambient Temperature

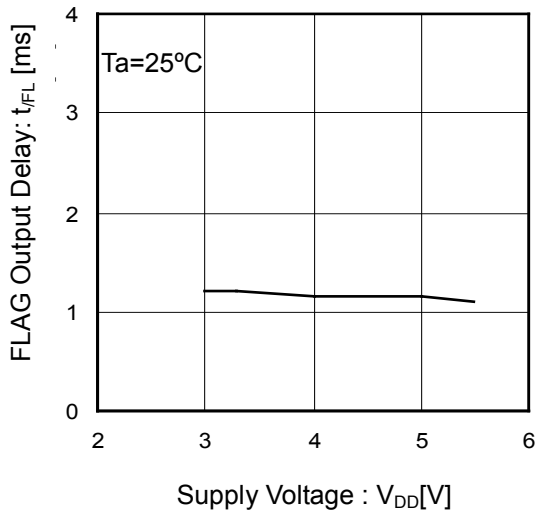

Figure 25. FLAG Output Delay vs Supply Voltage

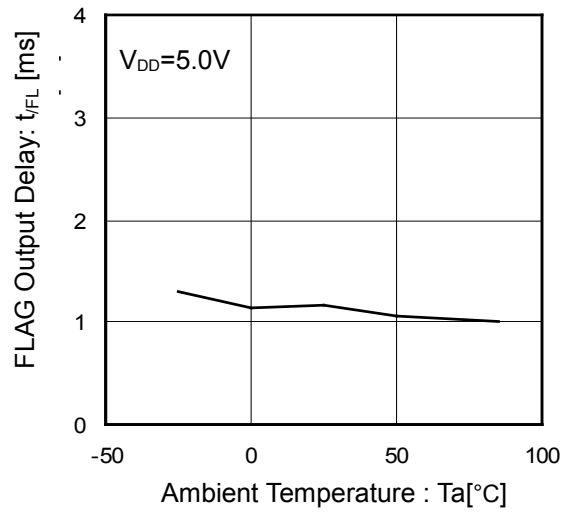

Figure 26. FLAG Output Delay vs Ambient Temperature

Typical Performance Curves - continued

BD2042AFJ/ BD2052AFJ

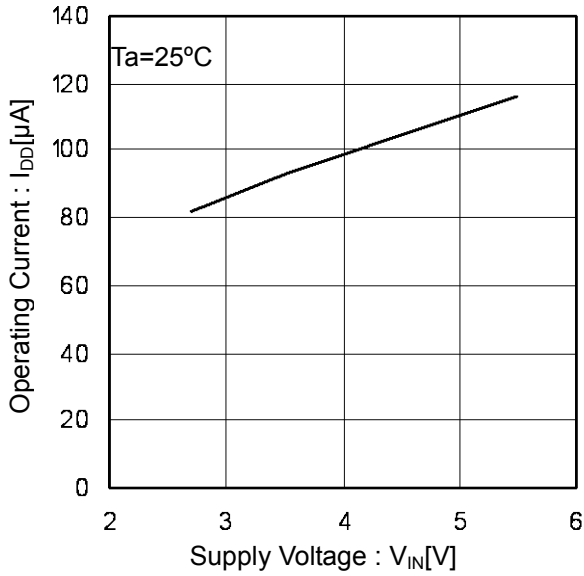

Figure 27. Operating Current vs Supply Voltage (EN, /EN Enable)

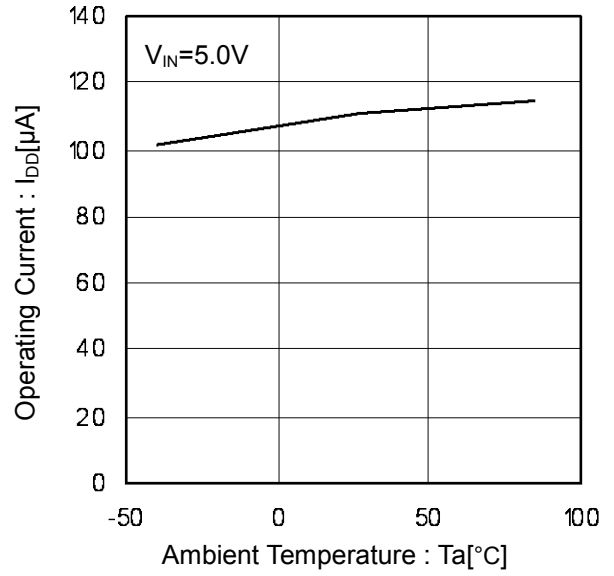

Figure 28. Operating Current vs Ambient Temperature (EN, /EN Enable)

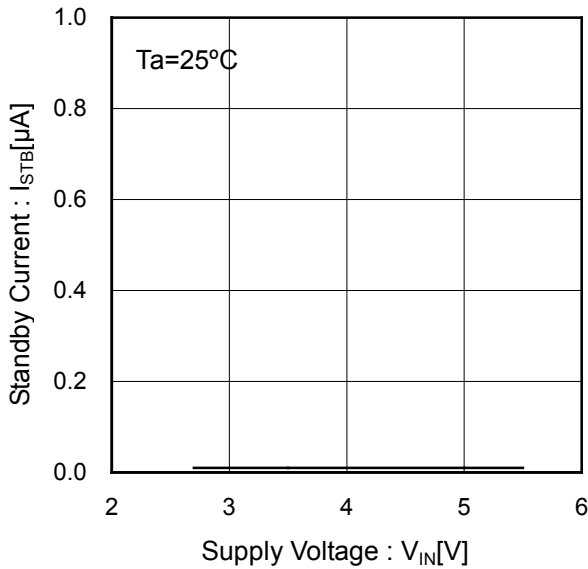

Figure 29. Standby Current vs Supply Voltage (EN, /EN Disable)

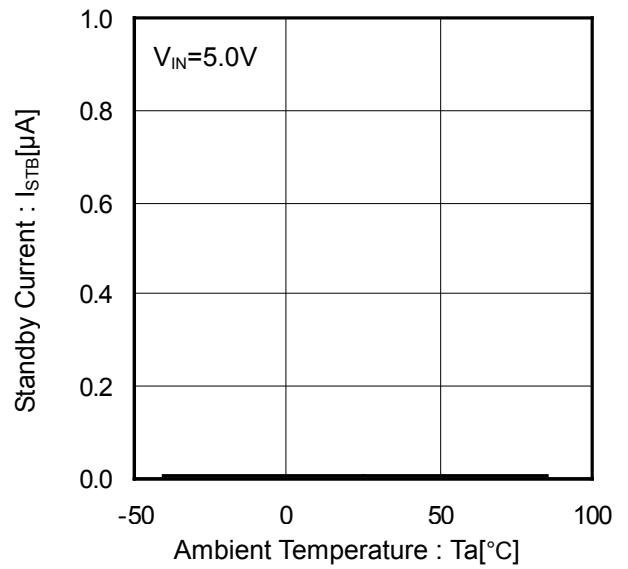

Figure 30. Standby Current vs Ambient Temperature (EN, /EN Disable)

Typical Performance Curves - continued

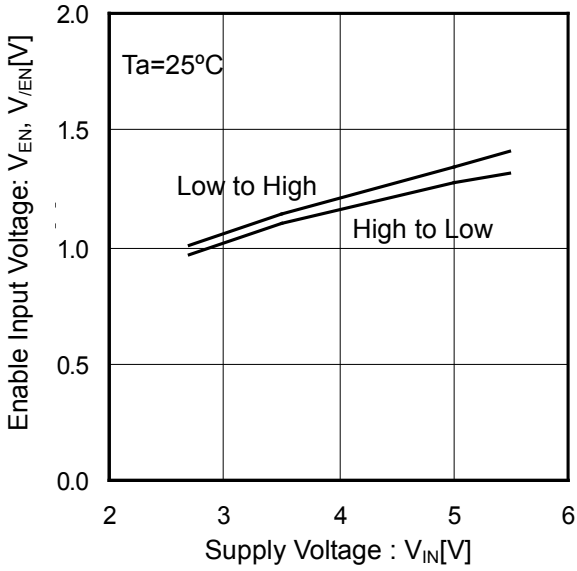

Figure 31. EN, /EN Input Voltage vs Supply Voltage

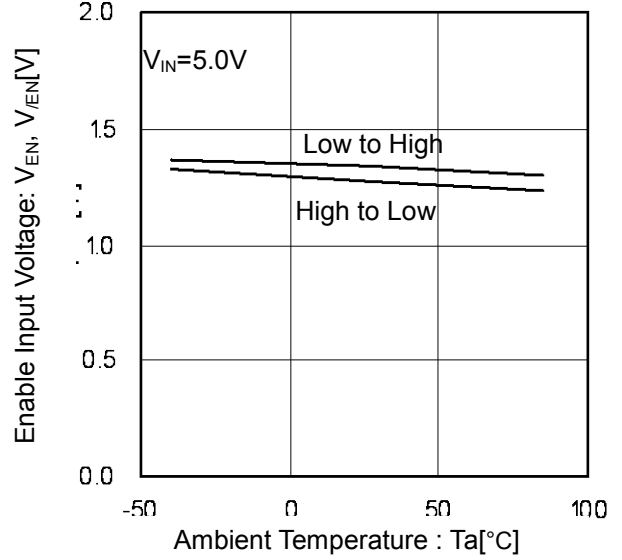

Figure 32. EN, /EN Input Voltage vs Ambient Temperature

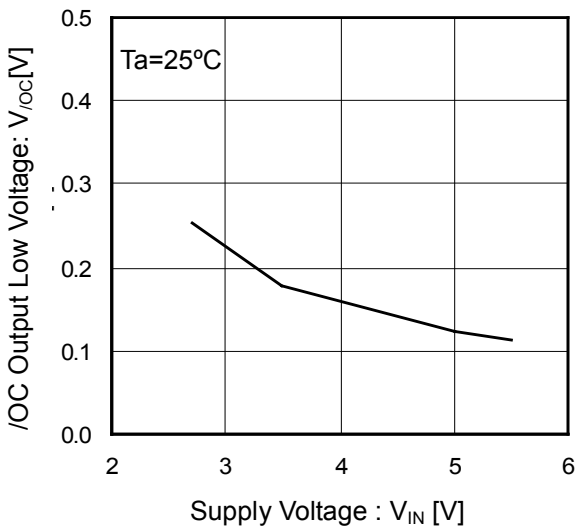

Figure 33. /OC Output Low Voltage vs Supply Voltage

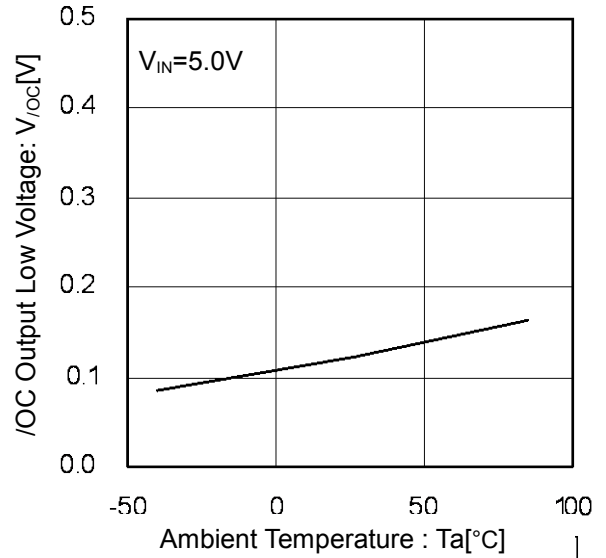

Figure 34. /OC Output Low Voltage vs Ambient Temperature

Typical Performance Curves - continued

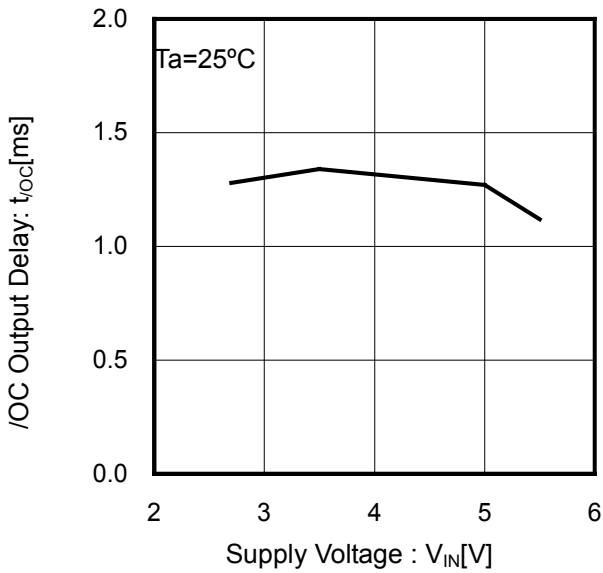

Figure 35. /OC Output Delay vs Supply Voltage

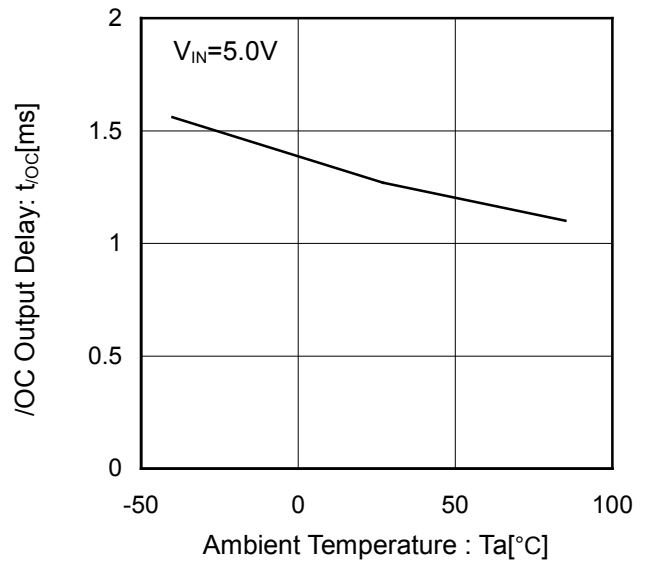

Figure 36. /OC Output Delay vs Ambient Temperature

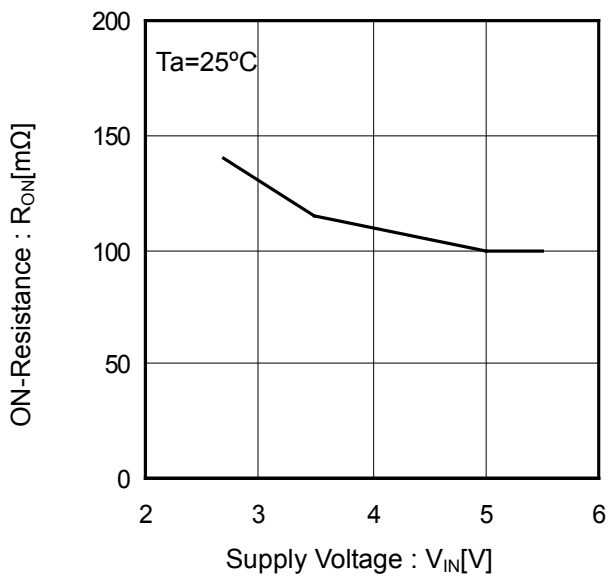

Figure 37. ON-Resistance vs Supply Voltage

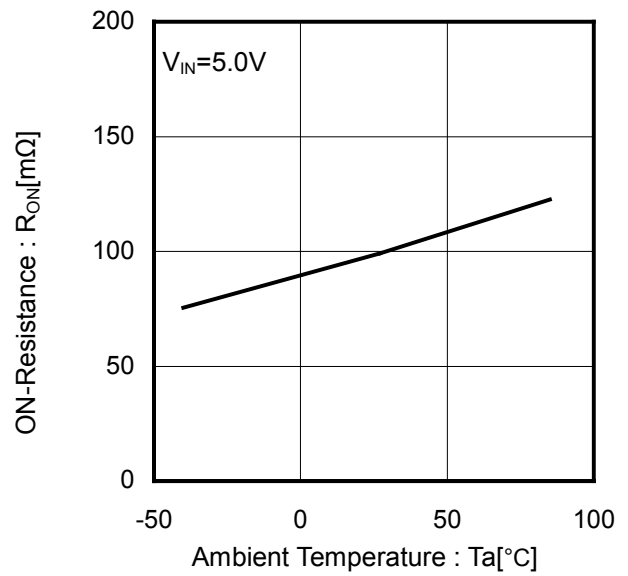

Figure 38. ON-Resistance vs Ambient Temperature

Typical Performance Curves - continued

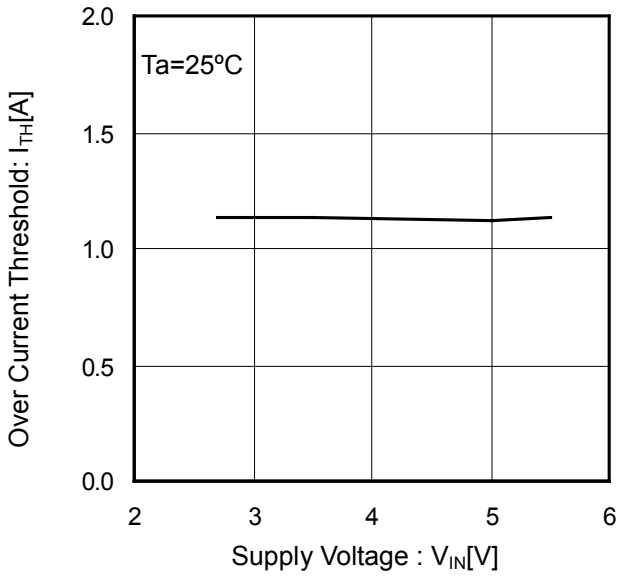

Figure 39. Over Current Threshold vs Supply Voltage

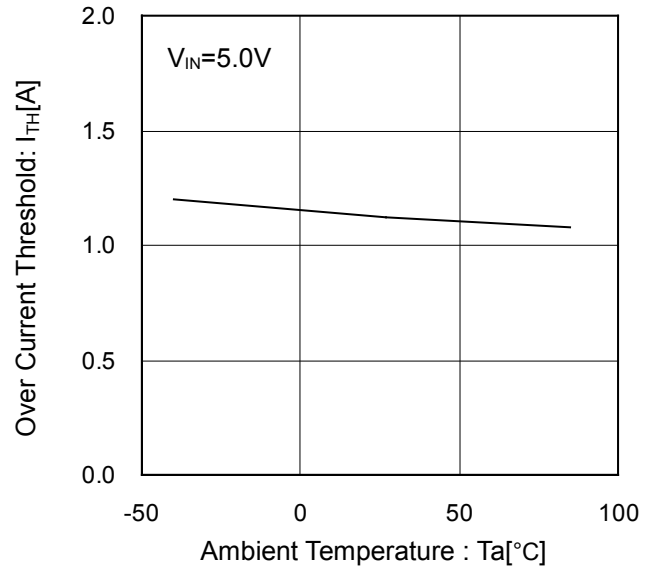

Figure 40. Over Current Threshold vs Ambient Temperature

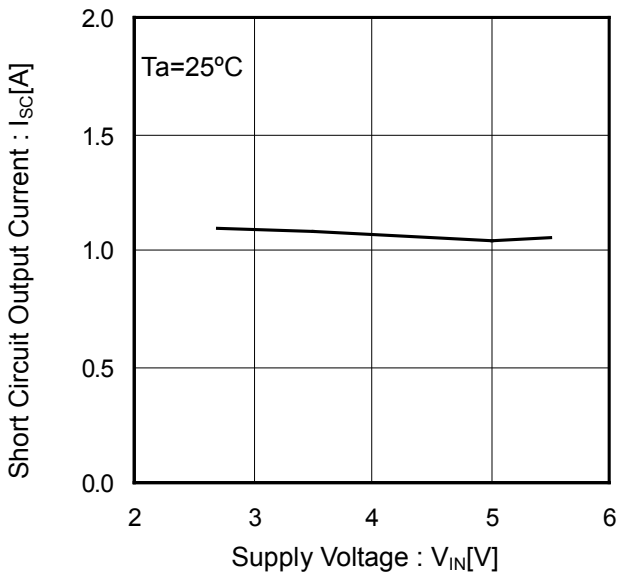

Figure 41. Short Circuit Output Current vs Supply Voltage

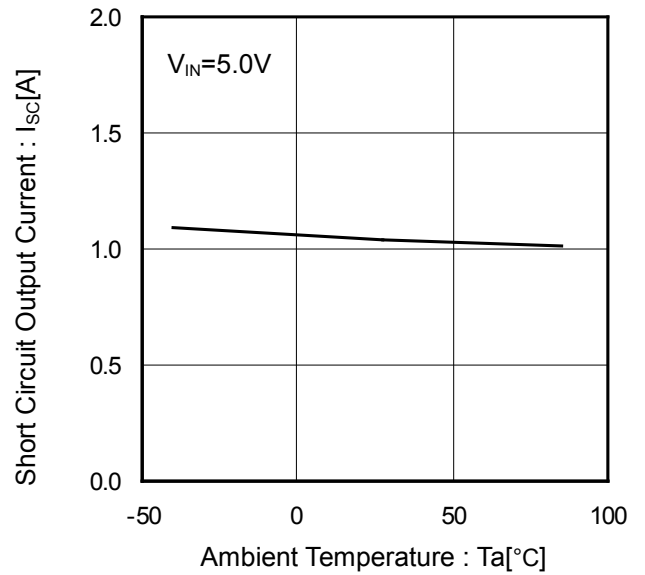

Figure 42. Short Circuit Output Current vs Ambient Temperature

Typical Performance Curves - continued

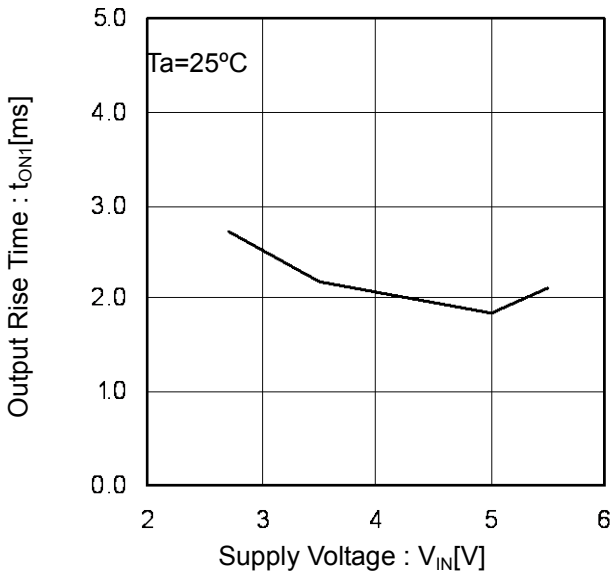

Figure 43. Output Rise Time vs Supply Voltage

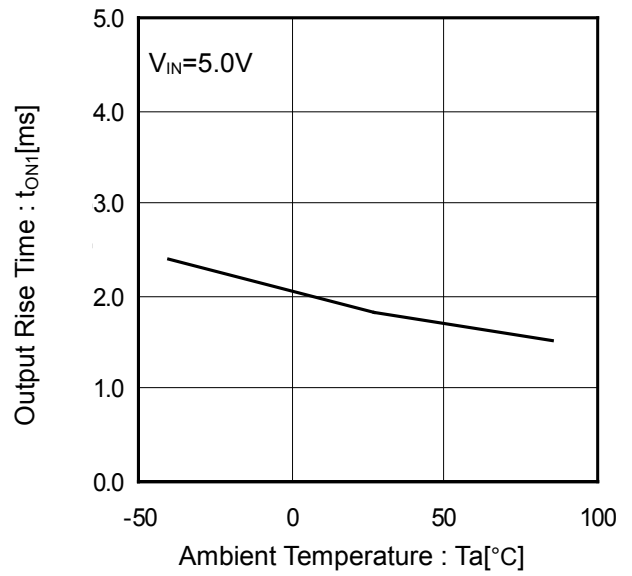

Figure 44. Output Rise Time vs Ambient Temperature

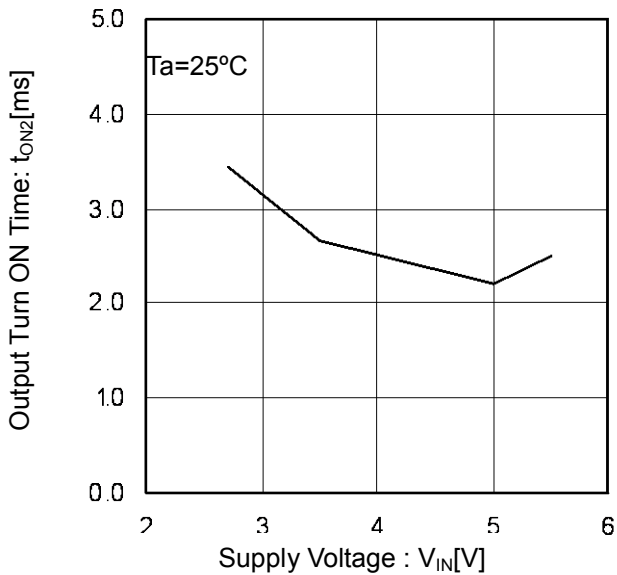

Figure 45. Output Turn ON Time vs Supply Voltage

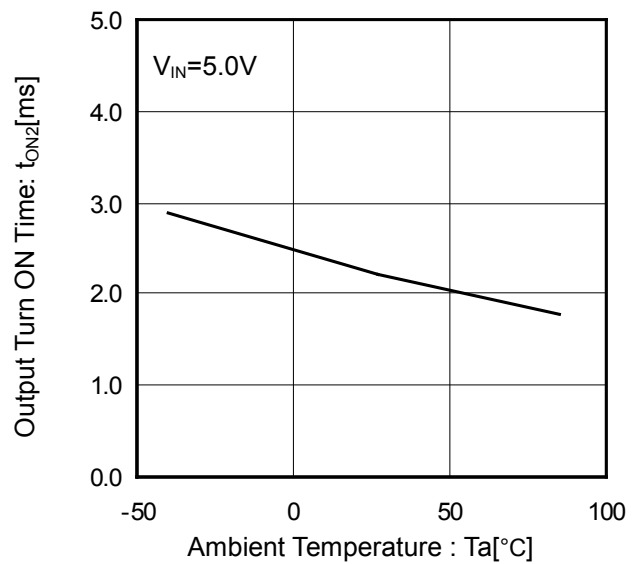

Figure 46. Output Turn ON Time vs Ambient Temperature

Typical Performance Curves - continued

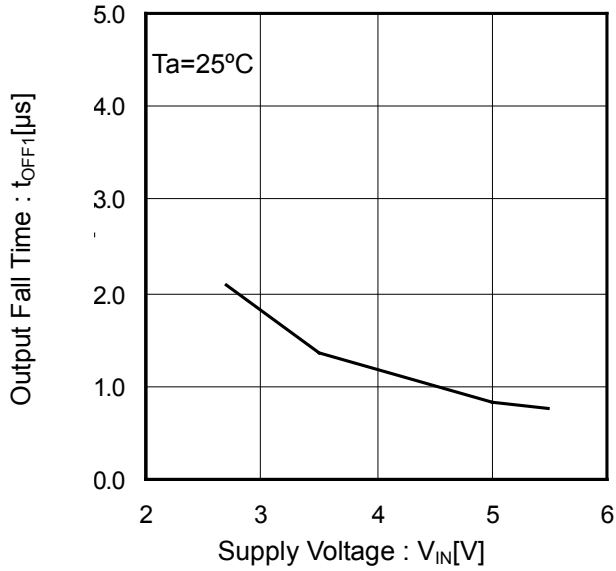

Figure 47. Output Fall Time vs Supply Voltage

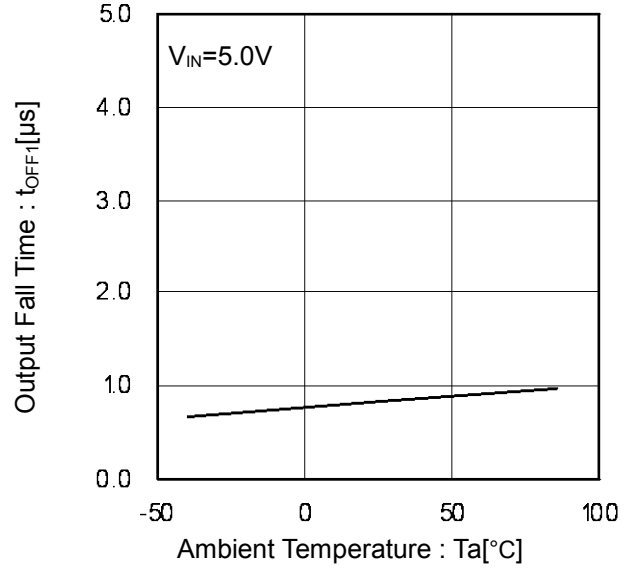

Figure 48. Output Fall Time vs Ambient Temperature

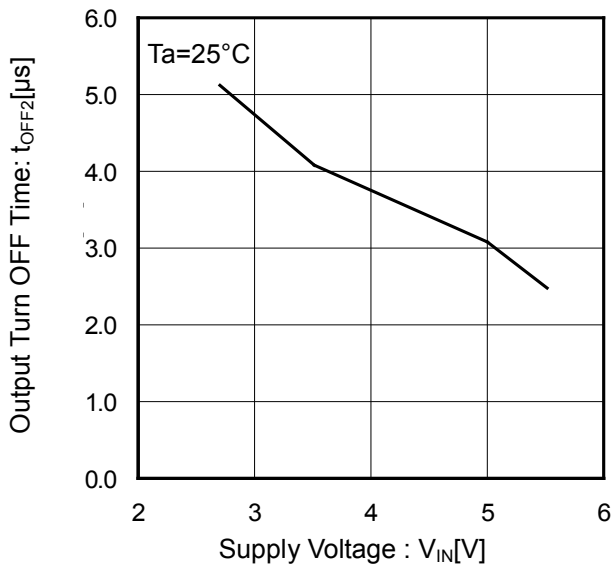

Figure 49. Output Turn OFF Time vs Supply Voltage

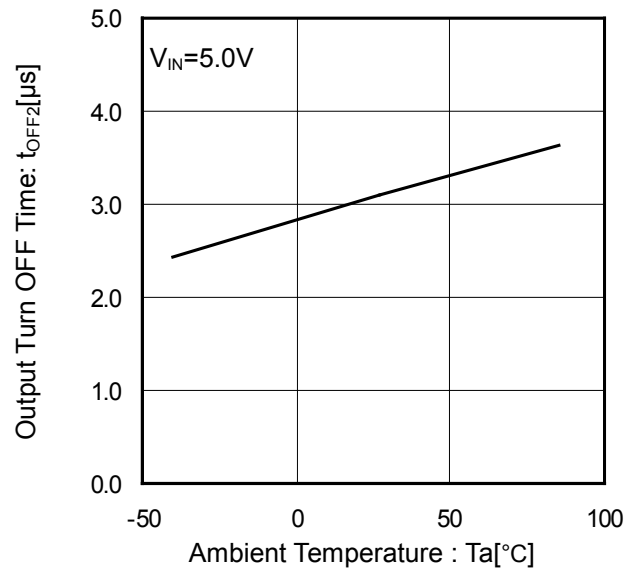

Figure 50. Output Turn OFF Time vs Ambient Temperature

Typical Performance Curves - continued

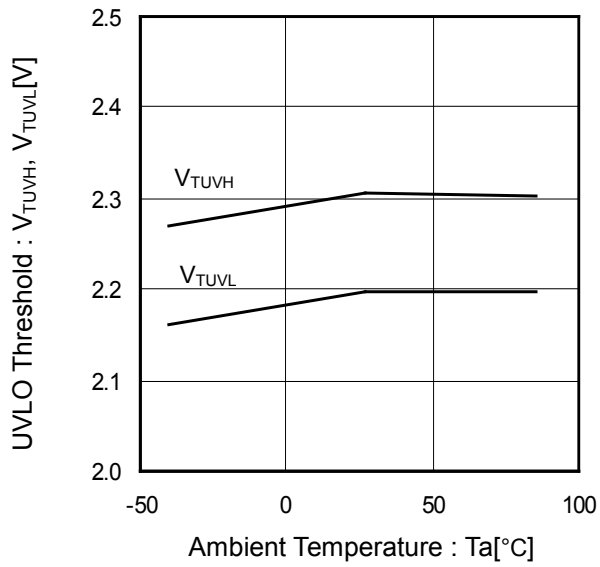

Figure 51. UVLO Threshold Voltage vs Ambient Temperature

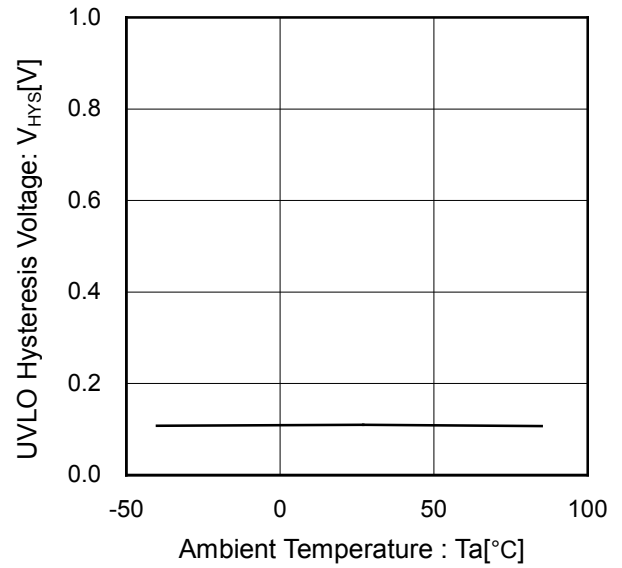

Figure 52. UVLO Hysteresis Voltage vs Ambient Temperature

Typical Wave Forms

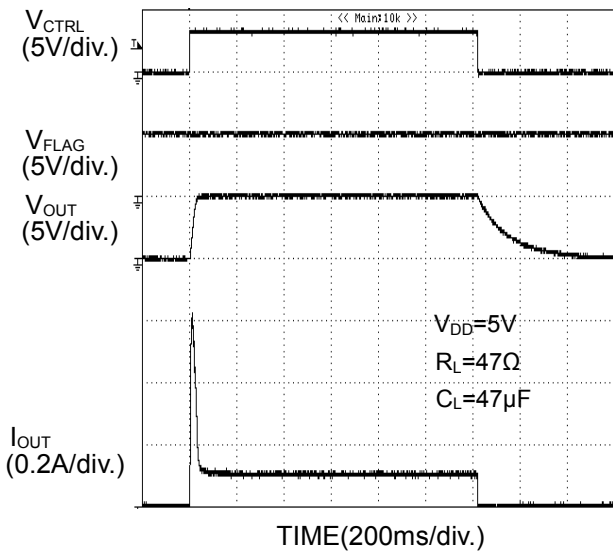

Figure 53. Output Rise / Fall Characteristic (BD6516F)

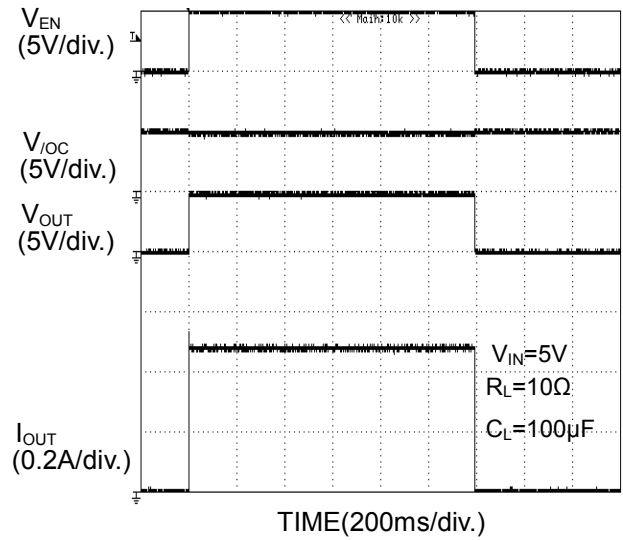

Figure 54. Output Rise / Fall Characteristic (BD2052AFJ)

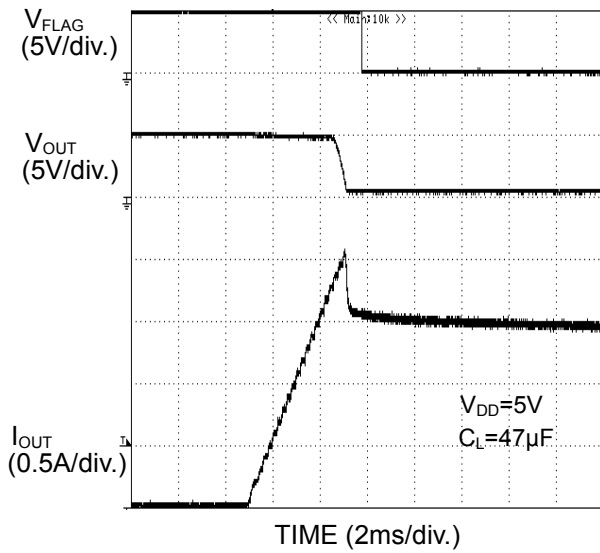

Figure 55. Over-Current Response Ramped Load (BD6516F)

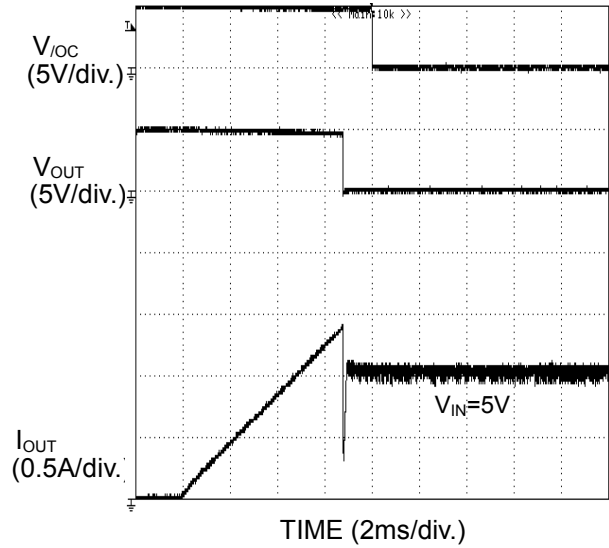

Figure 56. Over-Current Response Ramped Load (BD2052AFJ)

Typical Wave Forms - continued

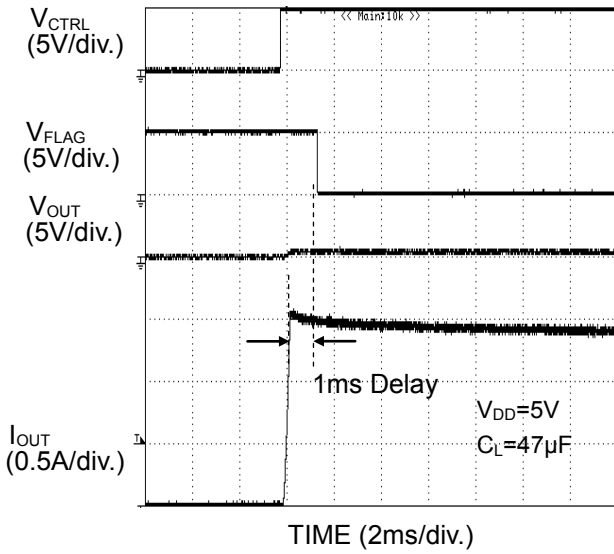

Figure 57. Over-Current Response Enable to Short Circuit (BD6516F)

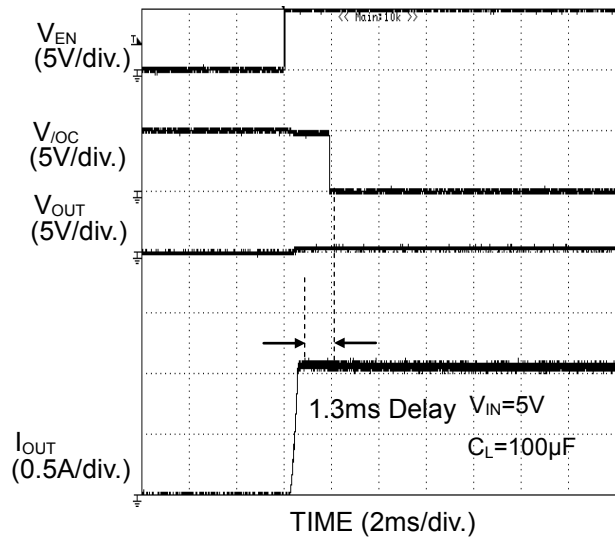

Figure 58. Over-Current Response Enable to 1Ω Short Circuit (BD2052AFJ)

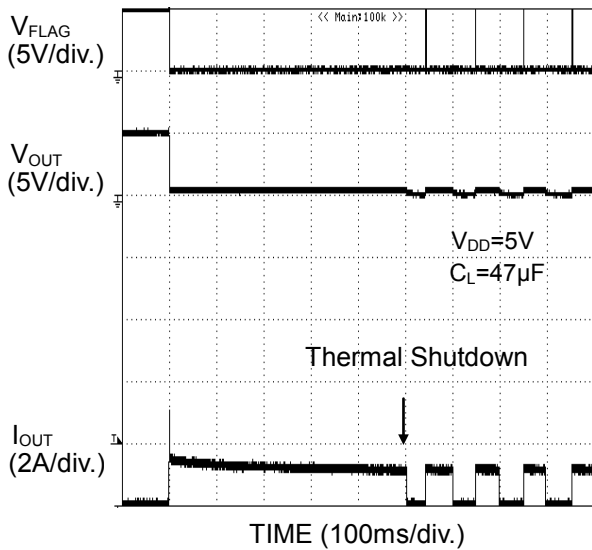

Figure 59. Over-Current Response 1Ω Load Connected at Enable (BD6516F)

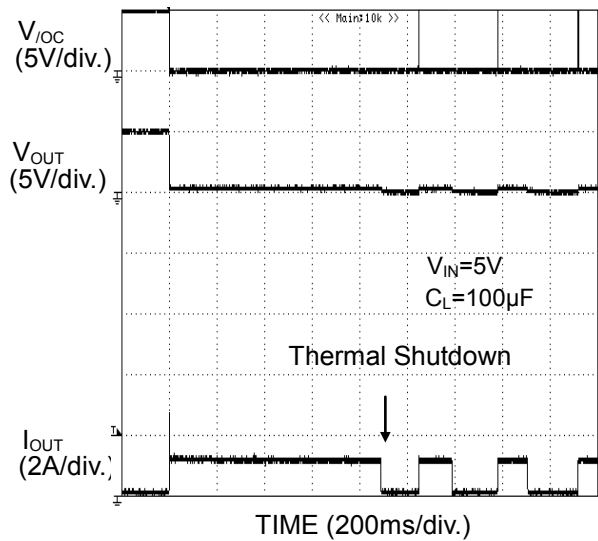
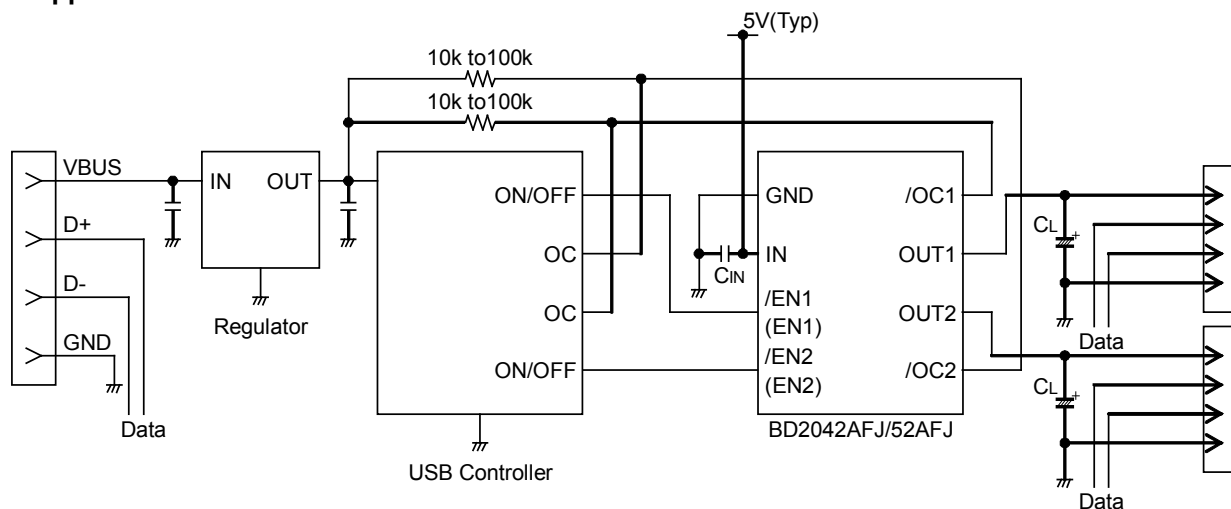

Figure 60. Over-Current Response 1Ω Load Connected at Enable (BD2052AFJ)

Regarding the output rise/fall and over current detection characteristics of BD6517F, BD2042AFJ refer to the characteristic of BD6516F, BD2052AFJ.

Typical Application Circuit



Application Information

Excessive current flow due to output short circuit, or so, may induce ringing because of the presence of an inductance between the supply line and IC. This event may cause IC malfunction during operation. To avoid this, connect a bypass capacitor between IN and GND pins. 1 μ F or higher is recommended.

Pull up flag output (/OC) by resistance value from 10k Ω to 100k Ω .

Set up values of C_L which satisfies the application.

The application circuit above does not guarantee its operation.

When using the circuit with changes to the external circuit constants, make sure to leave an adequate margin for external components including AC/DC characteristics as well as IC transient characteristics.

Functional Description

1. Switch Operation

VDD(IN) pin and OUT pin are connected to the drain and the source of switch MOSFET respectively. The VDD(IN) pin is also used as a power source for internal control circuit.

When the switch is turned on from CTRL(EN) control input, VDD(IN) and OUT are connected. In a normal condition, current flows from VDD to OUT. If the voltage at OUT is higher than VDD, current flows from OUT to VDD since there is no parasitic diode and it is possible to prevent current flow from OUT to VDD(IN).

2. Thermal Shutdown (TSD)

Thermal shutdown circuit turns off the switch and outputs an error flag when the junction temperature in the chip exceeds a threshold temperature. The thermal shutdown circuit works when either of the two control signals is active.

In BD6516F/BD6517F, the switches of both OUTA and OUTB turn off and output error flags;. BD2042AFJ/ BD2052AFJ has dual threshold temperature for its thermal shutdown. Since thermal shutdown works at a lower junction temperature, only the switch with an over current state turns off whenever over current occurs and outputs an error flag.

Thermal shutdown detection has hysteresis. Therefore, when the junction temperature goes down, switch turns on and error flag is cancelled. Unless the increase of the chip's temperature is removed or the output of power switch is turned off, this operation repeats.

3. Over-Current Detection/Limit Circuit

The over current detection circuit limits current (I_{SC}) and outputs an error flag (/OC) when current flowing in each switch MOSFET exceeds a specified value. There are three types of response against over current. The over current detection circuit works when the switch is on (CTRL, EN signal is active).

- (1) When the switch is turned on while the output is in short-circuit status, the switch goes into current limit status immediately.
- (2) When the output short-circuits or high-current load is connected while the switch is on, very large current flows until the over current limit circuit reacts. When the current detection and limit circuit works, current limitation is carried out.
- (3) When the output current increases gradually, current limitation does not work until the output current exceeds the over current detection value. When it exceeds the detection value, current limitation is carried out.

4. Under Voltage Lockout (UVLO)

UVLO circuit turns off the switch to prevent malfunction when the supply voltage is below the UVLO threshold level, The UVLO circuit works when either of two control signals is active.

©BD2042AFJ/BD2052AFJ

UVLO circuit prevents the switch from turning on until the V_{IN} exceeds 2.3V(Typ). If the V_{IN} drops below 2.2V(Typ) while the switch is ON, then UVLO shuts OFF the switch. UVLO has hysteresis of 100mV(Typ).

5. Error Flag (/OC) Output

Error flag output is an N-MOS open drain output.

At detection of over current limit and thermal shutdown, /OC outputs a low level signal. Error flag output (/OC) at over current detection has a delay filter. This delay filter prevents instantaneous current detection such as inrush current at switch ON, or applying external power supplies. If fault flag output is unused, /OC pin should be connected to open or ground line.

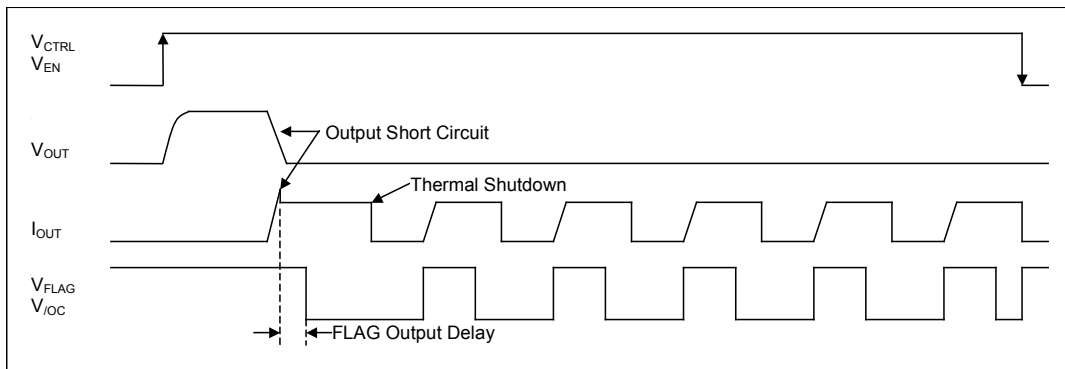
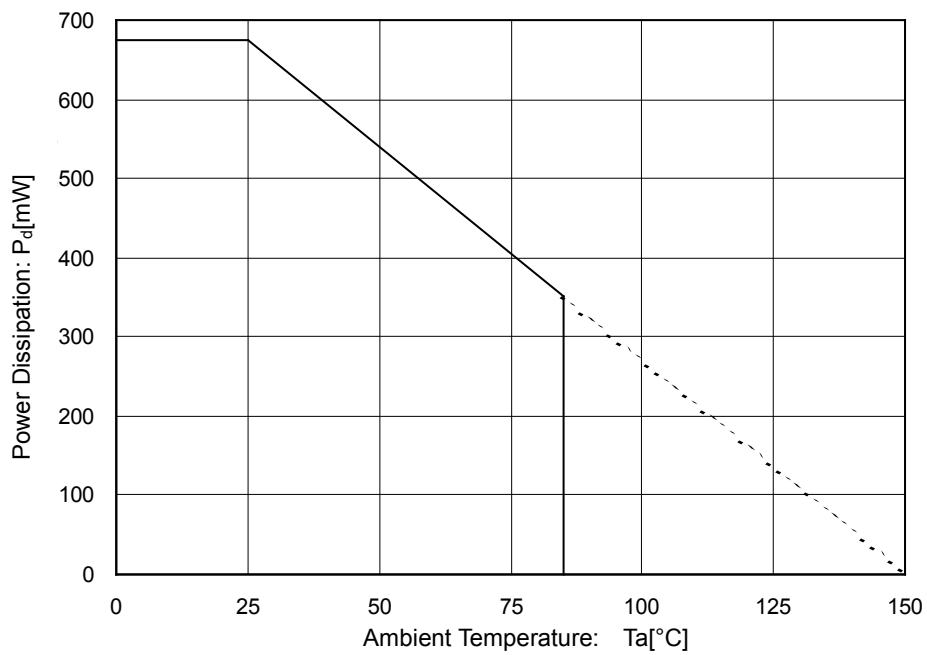

Figure 61. BD6516F/ BD6517F/BD2042AFJ/ BD2052AFJ Over Current Detection, Thermal Shutdown Timing Diagram (V_{CTRL} , V_{EN} of BD6517F/BD2042AFJ Active Low)

Power Dissipation
(SOP8, SOP-J8)



70mm x 70mm x 1.6mm Glass Epoxy Board

Figure 62. Power Dissipation Curve

I/O Equivalence Circuit

BD6516F/BD6517F

Symbol	Pin No.	Equivalence Circuit
CTRLA CTRLB	1, 4	
FLAGA FLAGB	2, 3	
OUTA OUTB	5, 8	

BD2042AFJ/BD2052AFJ

Symbol	Pin No	Equivalence Circuit
/EN1(EN1) /EN2(EN2)	3, 4	
/OC1 /OC2	5, 8	
OUT1 OUT2	6, 7	

Operational Notes

1. Reverse Connection of Power Supply

Connecting the power supply in reverse polarity can damage the IC. Take precautions against reverse polarity when connecting the power supply, such as mounting an external diode between the power supply and the IC's power supply pins.

2. Power Supply Lines

Design the PCB layout pattern to provide low impedance supply lines. Separate the ground and supply lines of the digital and analog blocks to prevent noise in the ground and supply lines of the digital block from affecting the analog block. Furthermore, connect a capacitor to ground at all power supply pins. Consider the effect of temperature and aging on the capacitance value when using electrolytic capacitors.

3. Ground Voltage

Ensure that no pins are at a voltage below that of the ground pin at any time, even during transient condition.

4. Ground Wiring Pattern

When using both small-signal and large-current ground traces, the two ground traces should be routed separately but connected to a single ground at the reference point of the application board to avoid fluctuations in the small-signal ground caused by large currents. Also ensure that the ground traces of external components do not cause variations on the ground voltage. The ground lines must be as short and thick as possible to reduce line impedance.

5. Thermal Consideration

Should by any chance the power dissipation rating be exceeded the rise in temperature of the chip may result in deterioration of the properties of the chip. The absolute maximum rating of the Pd stated in this specification is when the IC is mounted on a 70mm x 70mm x 1.6mm glass epoxy board. In case of exceeding this absolute maximum rating, increase the board size and copper area to prevent exceeding the Pd rating.

6. Recommended Operating Conditions

These conditions represent a range within which the expected characteristics of the IC can be approximately obtained. The electrical characteristics are guaranteed under the conditions of each parameter.

7. Inrush Current

When power is first supplied to the IC, it is possible that the internal logic may be unstable and inrush current may flow instantaneously due to the internal powering sequence and delays, especially if the IC has more than one power supply. Therefore, give special consideration to power coupling capacitance, power wiring, width of ground wiring, and routing of connections.

8. Operation Under Strong Electromagnetic Field

Operating the IC in the presence of a strong electromagnetic field may cause the IC to malfunction.

9. Testing on Application Boards

When testing the IC on an application board, connecting a capacitor directly to a low-impedance output pin may subject the IC to stress. Always discharge capacitors completely after each process or step. The IC's power supply should always be turned off completely before connecting or removing it from the test setup during the inspection process. To prevent damage from static discharge, ground the IC during assembly and use similar precautions during transport and storage.

10. Inter-pin Short and Mounting Errors

Ensure that the direction and position are correct when mounting the IC on the PCB. Incorrect mounting may result in damaging the IC. Avoid nearby pins being shorted to each other especially to ground, power supply and output pin. Inter-pin shorts could be due to many reasons such as metal particles, water droplets (in very humid environment) and unintentional solder bridge deposited in between pins during assembly to name a few.

Operational Notes - continued

11. Unused Input Pins

Input pins of an IC are often connected to the gate of a MOS transistor. The gate has extremely high impedance and extremely low capacitance. If left unconnected, the electric field from the outside can easily charge it. The small charge acquired in this way is enough to produce a significant effect on the conduction through the transistor and cause unexpected operation of the IC. So unless otherwise specified, unused input pins should be connected to the power supply or ground line.

12. Regarding the Input Pin of the IC

This monolithic IC contains P+ isolation and P substrate layers between adjacent elements in order to keep them isolated. P-N junctions are formed at the intersection of the P layers with the N layers of other elements, creating a parasitic diode or transistor. For example (refer to figure below):

When GND > Pin A and GND > Pin B, the P-N junction operates as a parasitic diode.
 When GND > Pin B, the P-N junction operates as a parasitic transistor.

Parasitic diodes inevitably occur in the structure of the IC. The operation of parasitic diodes can result in mutual interference among circuits, operational faults, or physical damage. Therefore, conditions that cause these diodes to operate, such as applying a voltage lower than the GND voltage to an input pin (and thus to the P substrate) should be avoided.

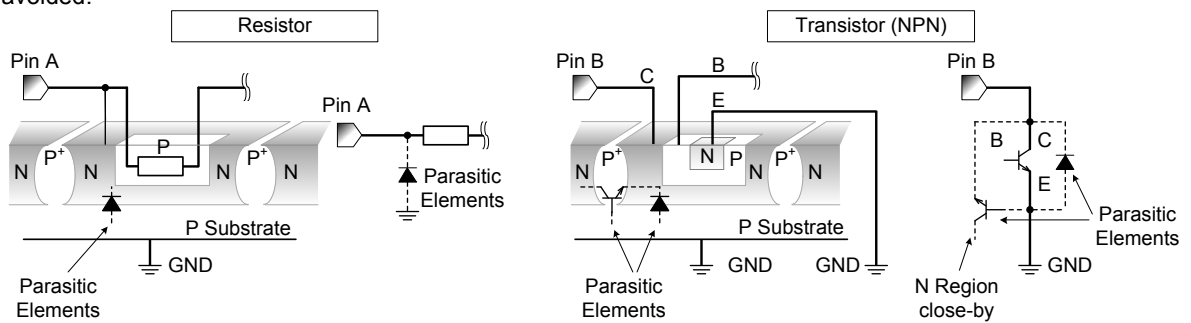

Figure 63. Example of monolithic IC structure

13. Ceramic Capacitor

When using a ceramic capacitor, determine the dielectric constant considering the change of capacitance with temperature and the decrease in nominal capacitance due to DC bias and others.

14. Thermal Shutdown Circuit(TSD)

This IC has a built-in thermal shutdown circuit that prevents heat damage to the IC. Normal operation should always be within the IC's power dissipation rating. If however the rating is exceeded for a continued period, the junction temperature (Tj) will rise which will activate the TSD circuit that will turn OFF all output pins. When the Tj falls below the TSD threshold, the circuits are automatically restored to normal operation.

Note that the TSD circuit operates in a situation that exceeds the absolute maximum ratings and therefore, under no circumstances, should the TSD circuit be used in a set design or for any purpose other than protecting the IC from heat damage.

15. Thermal design

Perform thermal design in which there are adequate margins by taking into account the power dissipation (Pd) in actual states of use.

Ordering Information

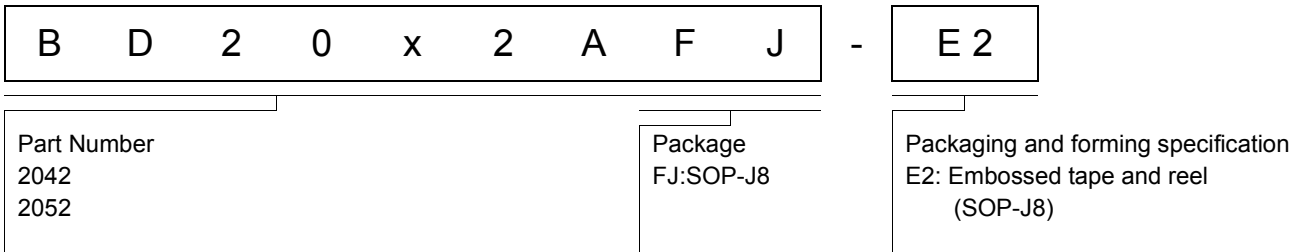
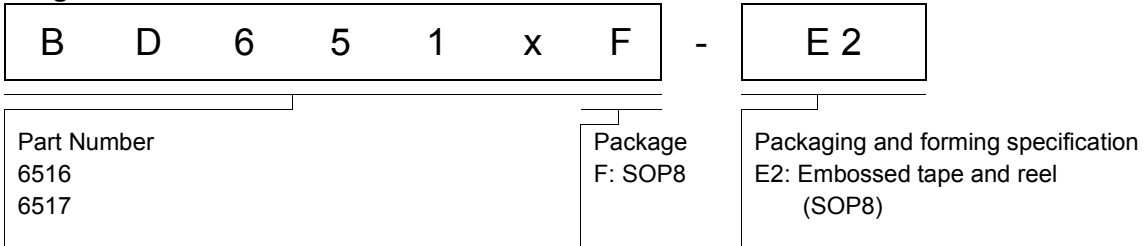

Marking Diagrams

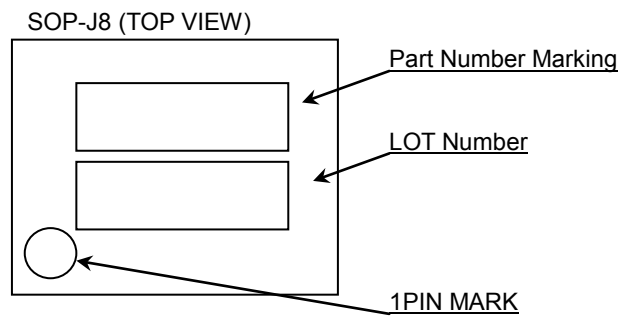
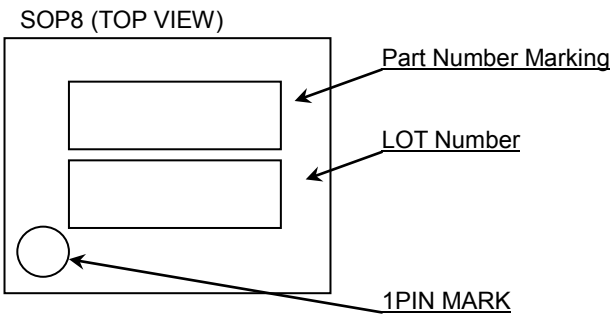

Part Number	Part Number Marking
BD6516F	D6516
BD6517F	D6517

Part Number	Part Number Marking
BD2042AFJ	D042A
BD2052AFJ	D052A

Physical Dimension, Tape and Reel Information

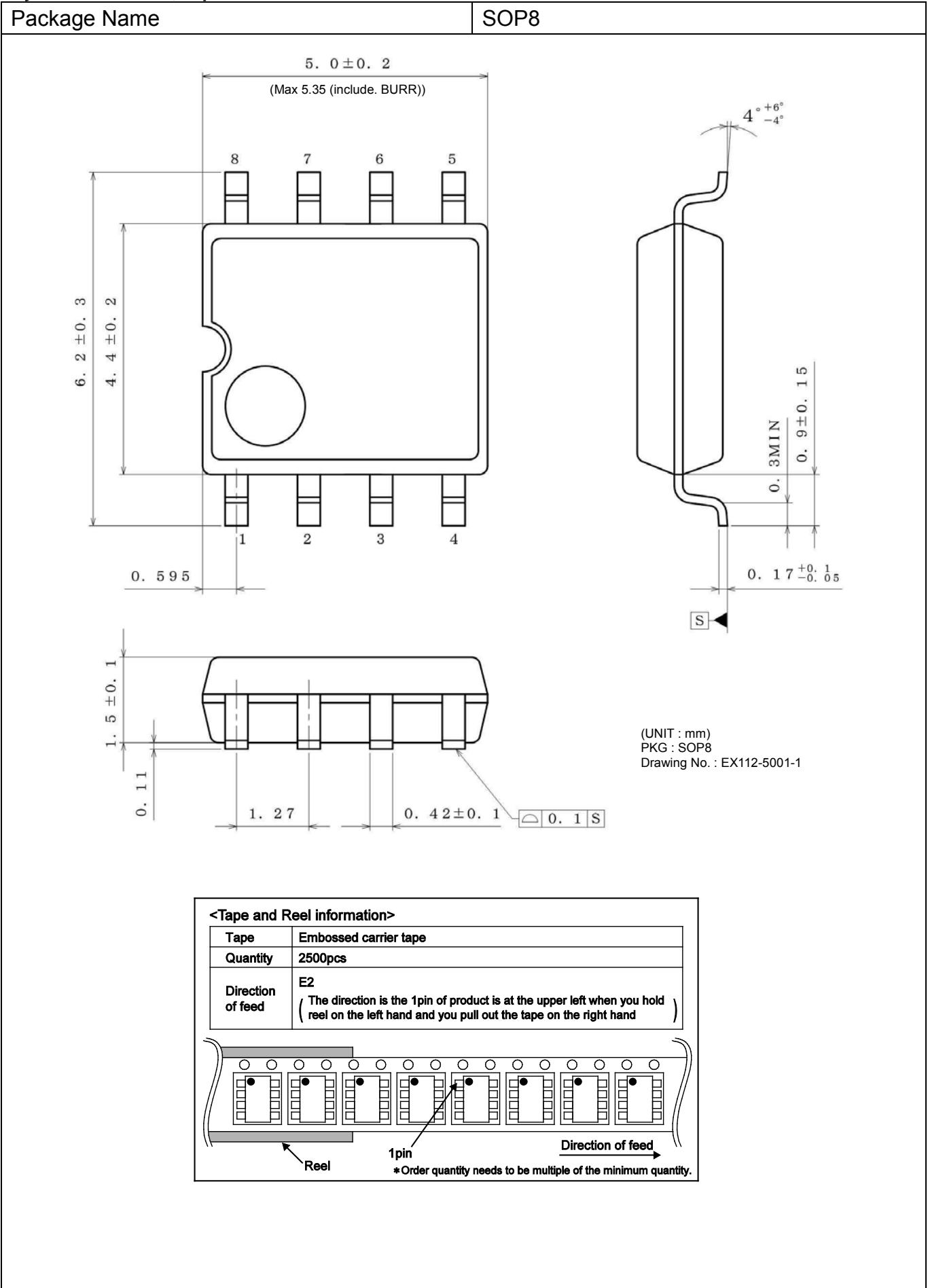

Physical Dimension, Tape and Reel Information – continued

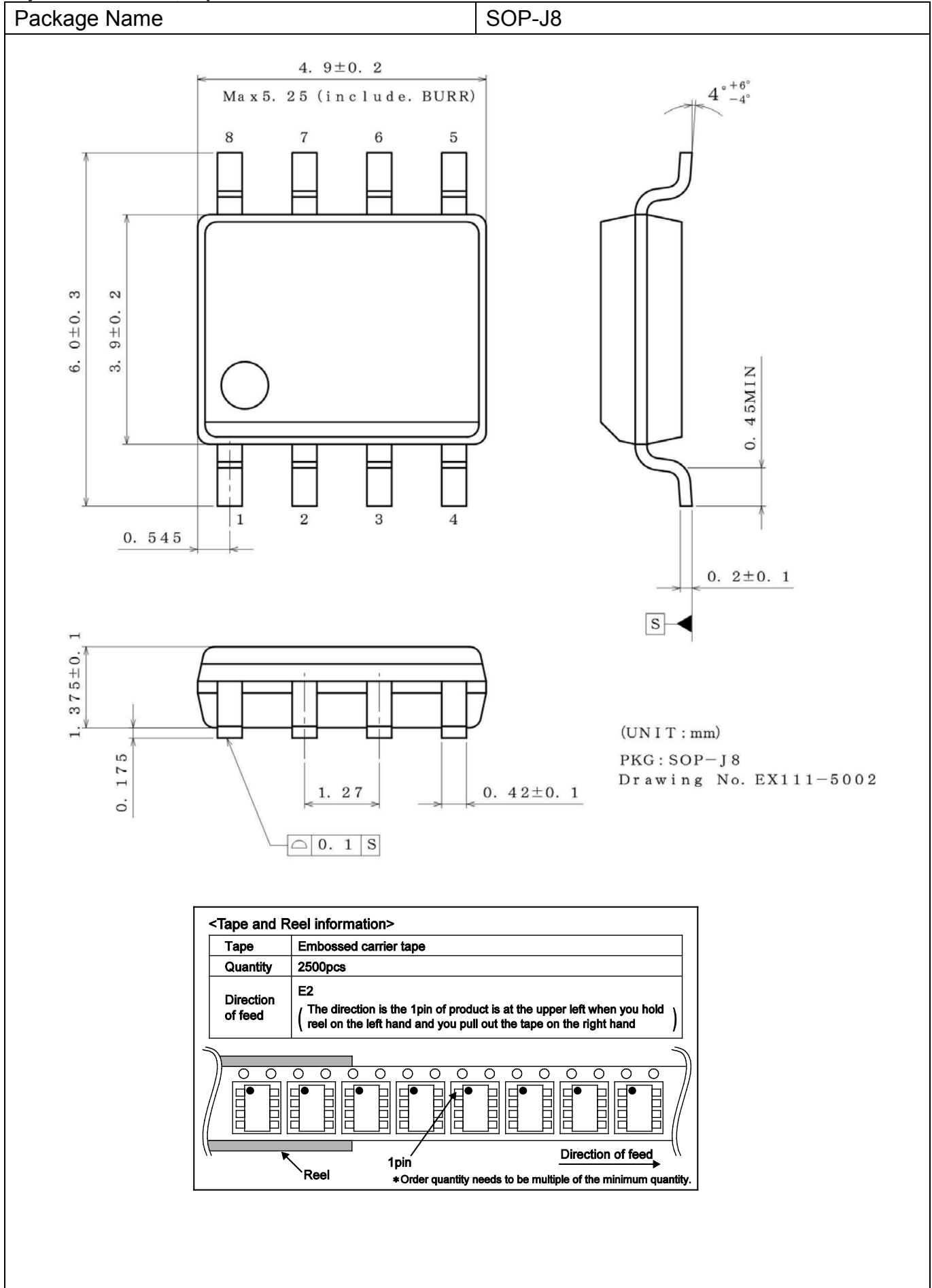

Revision History

Date	Revision	Changes
11.Mar.2013	001	New Release
25.Jun.2013	002	Changed character color from RED to BLACK on page 6.
21.Aug.2014	003	Applied the ROHM Standard Style and improved understandability. Delete BD6512F and BD6513F.

Notice

Precaution on using ROHM Products

- Our Products are designed and manufactured for application in ordinary electronic equipments (such as AV equipment, OA equipment, telecommunication equipment, home electronic appliances, amusement equipment, etc.). If you intend to use our Products in devices requiring extremely high reliability (such as medical equipment ^(Note 1), transport equipment, traffic equipment, aircraft/spacecraft, nuclear power controllers, fuel controllers, car equipment including car accessories, safety devices, etc.) and whose malfunction or failure may cause loss of human life, bodily injury or serious damage to property ("Specific Applications"), please consult with the ROHM sales representative in advance. Unless otherwise agreed in writing by ROHM in advance, ROHM shall not be in any way responsible or liable for any damages, expenses or losses incurred by you or third parties arising from the use of any ROHM's Products for Specific Applications.

(Note1) Medical Equipment Classification of the Specific Applications

JAPAN	USA	EU	CHINA
CLASS III	CLASS III	CLASS II b	CLASS III
CLASS IV		CLASS III	

- ROHM designs and manufactures its Products subject to strict quality control system. However, semiconductor products can fail or malfunction at a certain rate. Please be sure to implement, at your own responsibilities, adequate safety measures including but not limited to fail-safe design against the physical injury, damage to any property, which a failure or malfunction of our Products may cause. The following are examples of safety measures:
 - Installation of protection circuits or other protective devices to improve system safety
 - Installation of redundant circuits to reduce the impact of single or multiple circuit failure
- Our Products are designed and manufactured for use under standard conditions and not under any special or extraordinary environments or conditions, as exemplified below. Accordingly, ROHM shall not be in any way responsible or liable for any damages, expenses or losses arising from the use of any ROHM's Products under any special or extraordinary environments or conditions. If you intend to use our Products under any special or extraordinary environments or conditions (as exemplified below), your independent verification and confirmation of product performance, reliability, etc. prior to use, must be necessary:
 - Use of our Products in any types of liquid, including water, oils, chemicals, and organic solvents
 - Use of our Products outdoors or in places where the Products are exposed to direct sunlight or dust
 - Use of our Products in places where the Products are exposed to sea wind or corrosive gases, including Cl₂, H₂S, NH₃, SO₂, and NO₂
 - Use of our Products in places where the Products are exposed to static electricity or electromagnetic waves
 - Use of our Products in proximity to heat-producing components, plastic cords, or other flammable items
 - Sealing or coating our Products with resin or other coating materials
 - Use of our Products without cleaning residue of flux (even if you use no-clean type fluxes, cleaning residue of flux is recommended); or Washing our Products by using water or water-soluble cleaning agents for cleaning residue after soldering
 - Use of the Products in places subject to dew condensation
- The Products are not subject to radiation-proof design.
- Please verify and confirm characteristics of the final or mounted products in using the Products.
- In particular, if a transient load (a large amount of load applied in a short period of time, such as pulse. is applied, confirmation of performance characteristics after on-board mounting is strongly recommended. Avoid applying power exceeding normal rated power; exceeding the power rating under steady-state loading condition may negatively affect product performance and reliability.
- De-rate Power Dissipation (Pd) depending on Ambient temperature (Ta). When used in sealed area, confirm the actual ambient temperature.
- Confirm that operation temperature is within the specified range described in the product specification.
- ROHM shall not be in any way responsible or liable for failure induced under deviant condition from what is defined in this document.

Precaution for Mounting / Circuit board design

- When a highly active halogenous (chlorine, bromine, etc.) flux is used, the residue of flux may negatively affect product performance and reliability.
- In principle, the reflow soldering method must be used; if flow soldering method is preferred, please consult with the ROHM representative in advance.

For details, please refer to ROHM Mounting specification

Precautions Regarding Application Examples and External Circuits

1. If change is made to the constant of an external circuit, please allow a sufficient margin considering variations of the characteristics of the Products and external components, including transient characteristics, as well as static characteristics.
2. You agree that application notes, reference designs, and associated data and information contained in this document are presented only as guidance for Products use. Therefore, in case you use such information, you are solely responsible for it and you must exercise your own independent verification and judgment in the use of such information contained in this document. ROHM shall not be in any way responsible or liable for any damages, expenses or losses incurred by you or third parties arising from the use of such information.

Precaution for Electrostatic

This Product is electrostatic sensitive product, which may be damaged due to electrostatic discharge. Please take proper caution in your manufacturing process and storage so that voltage exceeding the Products maximum rating will not be applied to Products. Please take special care under dry condition (e.g. Grounding of human body / equipment / solder iron, isolation from charged objects, setting of Ionizer, friction prevention and temperature / humidity control).

Precaution for Storage / Transportation

1. Product performance and soldered connections may deteriorate if the Products are stored in the places where:
 - [a] the Products are exposed to sea winds or corrosive gases, including Cl₂, H₂S, NH₃, SO₂, and NO₂
 - [b] the temperature or humidity exceeds those recommended by ROHM
 - [c] the Products are exposed to direct sunshine or condensation
 - [d] the Products are exposed to high Electrostatic
2. Even under ROHM recommended storage condition, solderability of products out of recommended storage time period may be degraded. It is strongly recommended to confirm solderability before using Products of which storage time is exceeding the recommended storage time period.
3. Store / transport cartons in the correct direction, which is indicated on a carton with a symbol. Otherwise bent leads may occur due to excessive stress applied when dropping of a carton.
4. Use Products within the specified time after opening a humidity barrier bag. Baking is required before using Products of which storage time is exceeding the recommended storage time period.

Precaution for Product Label

QR code printed on ROHM Products label is for ROHM's internal use only.

Precaution for Disposition

When disposing Products please dispose them properly using an authorized industry waste company.

Precaution for Foreign Exchange and Foreign Trade act

Since our Products might fall under controlled goods prescribed by the applicable foreign exchange and foreign trade act, please consult with ROHM representative in case of export.

Precaution Regarding Intellectual Property Rights

1. All information and data including but not limited to application example contained in this document is for reference only. ROHM does not warrant that foregoing information or data will not infringe any intellectual property rights or any other rights of any third party regarding such information or data. ROHM shall not be in any way responsible or liable for infringement of any intellectual property rights or other damages arising from use of such information or data.:
2. No license, expressly or implied, is granted hereby under any intellectual property rights or other rights of ROHM or any third parties with respect to the information contained in this document.

Other Precaution



1. This document may not be reprinted or reproduced, in whole or in part, without prior written consent of ROHM.
2. The Products may not be disassembled, converted, modified, reproduced or otherwise changed without prior written consent of ROHM.
3. In no event shall you use in any way whatsoever the Products and the related technical information contained in the Products or this document for any military purposes, including but not limited to, the development of mass-destruction weapons.
4. The proper names of companies or products described in this document are trademarks or registered trademarks of ROHM, its affiliated companies or third parties.

General Precaution

1. Before you use our Products, you are requested to carefully read this document and fully understand its contents. ROHM shall not be in any way responsible or liable for failure, malfunction or accident arising from the use of any ROHM's Products against warning, caution or note contained in this document.
2. All information contained in this document is current as of the issuing date and subject to change without any prior notice. Before purchasing or using ROHM's Products, please confirm the latest information with a ROHM sales representative.
3. The information contained in this document is provided on an "as is" basis and ROHM does not warrant that all information contained in this document is accurate and/or error-free. ROHM shall not be in any way responsible or liable for any damages, expenses or losses incurred by you or third parties resulting from inaccuracy or errors of or concerning such information.

Looking for pricing, stock, or lifecycle information?

Click below to explore more details on WIN SOURCE:

-  [View BD6517F-E2 on WIN SOURCE](#)
-  [Rohm Semiconductor](#) Information

Optimize Your Supply Chain with WIN SOURCE Solutions

-  Global Sourcing Solution
-  Obsolete Management
-  Cost Control Management
-  Shortage Management
-  Alternative Solution
-  Excess Inventory Management