



**THE DATASHEET OF
BD6081GU-E2**



LED Drivers for LCD Backlights

Multifunction Backlight LED Drivers for Small LCD Panels (Charge Pump Type)



BD6081GU, BD6081GVW

No.11040EAT27

●Description

BD6081GU / BD6081GVW is compound LED Driver which is the most suitable for the cellular phone.

Main LCD Back Light LED Driver (Max 4 Light), Sub LCD Back Light LED Driver (Max 2 Light), 2 system RGB LED Drivers, 2Ch LDO (2.8V/1.8V) included. This is PMIC (Power Management IC) that is the most suitable for "the indication part" of the cellular phone. A charge pump form is adopted, and a coil is never used for the part DC/DC. This IC achieves compact size with the chip size package (VCSP85H3). [BD6081GU] This IC solves a mounting problem by BGA package (SBGA063W060). [BD6081GVW]

●Features

- 1) Main LCD Back Light LED Driver (Max 4 Light)
4 Lighting / 3 Lighting can be chosen (register setting)
- 2) Sub LCD Back Light LED Driver (Max 2 Light)
2 Lighting / 1 Lighting can be chosen (register setting)
- 3) RGB LED Driver (2 System)
Slope control is built in. (2 system independence can be controlled.)
LED connection (for G1LED, G2LED, B1LED, B2LED) can be set up in the battery or the DC/DC output. (register setting)
LED connection (for R1LED, R2LED) can be set up in the battery only.
- 4) 2ch Series Regulator
2.8V output I_{max}=150mA
1.8V output I_{max}=150mA (normal mode)
1.8V output low current consumption mode / normal mode Switching is possible. (The outside pin control / register setting)
- 5) Charge Pump DC/DC
Soft start Functions
Over voltage protection (Auto-return type)
Over current protection (Auto-return type)
- 6) Thermal shutdown (Auto-return type)
- 7) I²C BUS Fast-mode (max 400kHz) Writing

*This chip is not designed to protect itself against radioactive rays.

*This material may be changed on its way to designing.

*This material is not the specification.

●Absolute Maximum Ratings (Ta=25 °C)

Parameter	Symbol	Ratings	Unit
Maximum Applied voltage	V _{MAX}	7	V
Power Dissipation	BD6081GU	P _d 1725 note1)	mW
	BD6081GVW	P _d 1060 note2)	mW
Operating Temperature Range	T _{opr}	-25 ~ +85	°C
Storage Temperature Range	T _{stg}	-55 ~ +150	°C

cote1) Power dissipation deleting is 13.8mW/ °C, when it's used in over 25 °C.
(It's deleting is on the board that is ROHM's standard))

Note2) Power dissipation deleting is 8.48mW/ °C, when it's used in over 25 °C.
(It's deleting is on the board that is ROHM's standard))

●Operating conditions (V_{BAT} ≥ V_{IO}, Ta = -25 ~ 85 °C)

Parameter	Symbol	Ratings	Unit
V _{BAT} input voltage	V _{BAT}	2.7 ~ 5.5	V
V _{IO} pin voltage	V _{IO}	1.65 ~ 3.3	V

● **Electrical Characteristics** (Unless otherwise specified, Ta=25°C, VBAT=3.6V, VIO=1.8V)

Parameter	Symbol	Limits			Unit	Condition
		Min.	Typ.	Max.		
【Circuit Current】						
VBAT Circuit current 1	IBAT1	-	0.1	3.0	μA	RESET=0V, VIO=0V
VBAT Circuit current 2	IBAT2	-	0.5	3.0	μA	RESET=0V, VIO=1.8V
VBAT Circuit current 3	IBAT3	-	6.2	9.5	μA	REG2 low current consumption mode, Io=0mA
VBAT Circuit current 4	IBAT4	-	100	150	μA	REG2 normal mode, Io=0mA
VBAT Circuit current 5	IBAT5	-	140	210	μA	REG1, REG2 normal mode, Io=0mA
VBAT Circuit current 6	IBAT6	-	63	95	mA	DC/DC x1 mode, Io=60mA, VBAT=4.0V
VBAT Circuit current 7	IBAT7	-	95	143	mA	DC/DC x1.5 mode, Io=60mA, VBAT=3.6V
VBAT Circuit current 8	IBAT8	-	125	188	mA	DC/DC x2 mode, Io=60mA, VBAT=2.7V
【LED Driver】						
LED current Step1	ILEDSTP1	32			Step	MLED1~4, SLED1~2
LED current Step2	ILEDSTP2	64			Step	R1LED, G1LED, B1LED, R2LED, G2LED, B2LED (with 0mA setting)
LED Maximum setup current 1	IMAX1	-	-	32	mA	MLED1~4, SLED1~2, ISET=120kΩ
LED Maximum setup current 2	IMAX2	-	-	31.5	mA	R1LED, G1LED, B1LED, R2LED, G2LED, B2LED, ISET=120kΩ
LED current accurate	ILED	18	20	22	mA	ILED=20mA, ISET=120kΩ
LED current Matching	ILEDMT	-	5	10	%	Between MLED1~4 Between SLED1~2 Between R1LED, G1LED and B1LED Between R2LED, G2LED and B2LED
LED OFF Leak current	ILKLED	-	-	1.0	μA	
【DC/DC(Charge Pump)】						
Output voltage	V ^{CP}	Vf+0.15	Vf+0.2	-	V	Vf is LED forward voltage
Current Load	IOUT	-	-	255	mA	VBAT≥3.2V, VOUT=4V
Oscillator frequency	fosc	0.8	1.0	1.2	MHz	
Over voltage protection detect voltage	OVP	-	6.0	6.5	V	
Over current protection detect current	OCP	-	250	375	mA	VOUT=0V
【REG1】						
Output voltage	Vo1	2.716	2.80	2.884	V	Io=150mA, VBAT≥3.1V
I/O voltage difference	Vsat1	-	0.2	0.3	V	VBAT=2.5V, Io=150mA
Load stability	ΔVo11	-	10	60	mV	Io=1~150mA
Input stability	ΔVo12	-	10	60	mV	VBAT=3.2~5.5V, Io=150mA
Ripple Rejection Ratio	RR1	30	40	-	dB	f=100Hz, Vin=200mVp-p
Short circuit current limit	Ilim01	-	225	450	mA	Vo=0V
Discharge resistor at OFF	ROFF1	-	1.0	1.5	kΩ	
【REG2】						
Output voltage 1	Vo21	1.74	1.8	1.86	V	Io=150mA (normal mode)
Output voltage 2	Vo22	1.71	1.8	1.89	V	Io=100μA (low current consumption mode)
Load stability	ΔVo21	-	10	60	mV	Io=1~150mA
Input stability	ΔVo22	-	10	60	mV	VBAT=3.2~5.5V, Io=150mA
Ripple Rejection Ratio	RR2	30	40	-	dB	f=100Hz, Vin=200mVp-p
Short circuit current limit	Ilim02	-	225	450	mA	Vo=0V
Discharge resistor at OFF	ROFF2	-	1.0	1.5	kΩ	

● **Electrical Characteristics** (Unless otherwise specified, Ta=25°C, VBAT=3.6V, VIO=1.8V)

Parameter	Symbol	Limits			Unit	Condition
		Min.	Typ.	Max.		
【I²C Input (SDA, SCL)】						
LOW level input voltage	VIL	-0.3	-	0.25 ×VIO	V	
HIGH level input voltage	VIH	0.75 ×VIO	-	VBAT+0.3	V	
Hysteresis of Schmitt trigger input	Vhys	0.05 ×VIO	-	-	V	
LOW level output voltage (SDA) at 3mA sink current	VOL	0	-	0.3	V	
Input current each I/O pin	lin	-10	-	10	μA	Input voltage = 0.1×VIO~0.9×VIO
【RESET, RGB1CNT, RGB2CNT】						
LOW level input voltage	VIL	-0.3	-	0.25 ×VIO	V	
HIGH level input voltage1	VIH1	0.75 ×VIO	-	VBAT+0.3	V	RESET Pin
HIGH level input voltage2	VIH2	0.75 ×VIO	-	VIO+0.3	V	RGB1CNT, RGB2CNT Pin
Input current each I/O pin1	lin	-10	-	10	μA	Input voltage = 0.1×VIO~0.9×VIO, RESET Pin
Input current each I/O pin2	lin	-	6	15	μA	Input voltage = .9×VIO, RGB1CNT, RGB2CNT Pin
【REG2EN, REG2MD】						
LOW level input voltage	VIL	-0.3	-	0.3	V	
HIGH level input voltage	VIH	1.4	-	VBAT,+0.3	V	
Input current each I/O pin	lin	-	6	15	μA	Vin=1.8V

● **Power dissipation (On the ROHM's standard board)**

BD6081GU

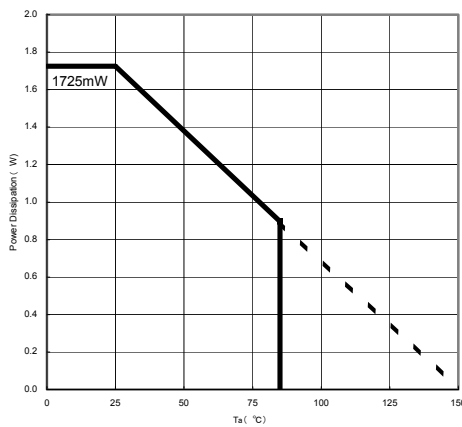

Fig.1

Information of the ROHM's standard board

Material: glass-epoxy
Size: 50mm×58mm×1.75mm (8 Layer)

BD6081GVW

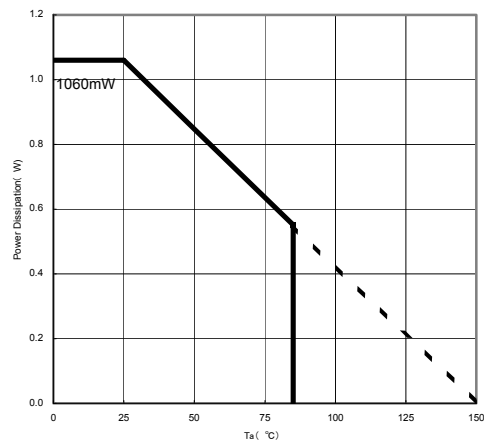

Fig.2

Information of the ROHM's standard board

Material: glass-epoxy
Size: 114.3mm×76.2mm×1.6mm

Pattern of the board: Refer to it that goes later.

●Block Diagram / Application Circuit example

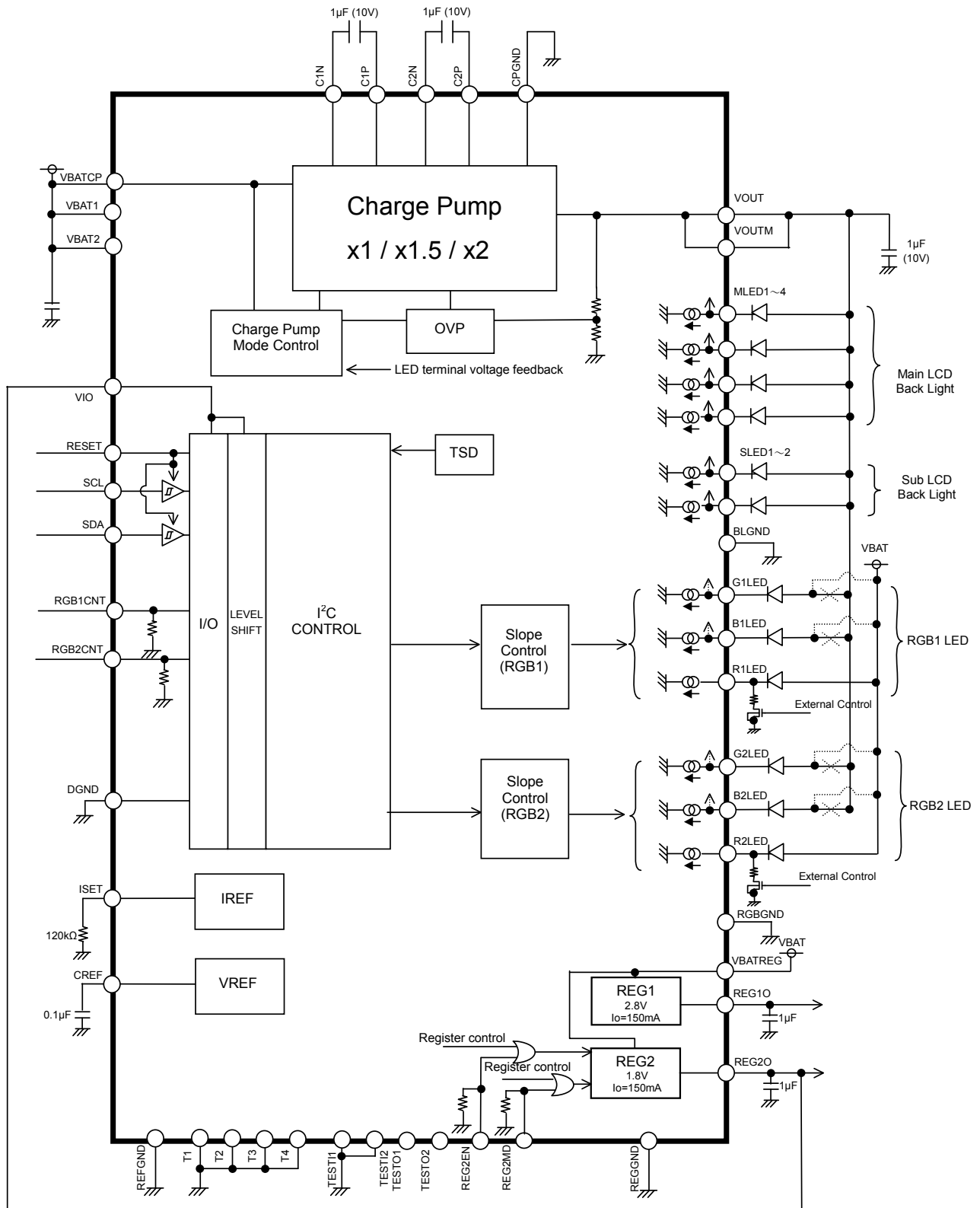



Fig.3 Block Diagram / Application Circuit example

● Pin Arrangement [Bottom View]

BD6081GU

G	T4	VBAT1	REG2O	VBATREG	REGGND	VIO	T3
F	REFGND	R1LED	CREF	REG1O	REG2MD	RGB1CNT	RESET
E	G1LED	B1LED	ISET	REG2EN	RGB2CNT	SDA	DGND
D	RGBGND	R2LED	TEST1	TEST2	SCL	VOUTM	VOUT
C	G2LED	B2LED	 index	TESTO2	TESTO1	C1P	C2P
B	SLED1	BLGND	MLED2	MLED4	CPGND	C1N	VBATCP
A	T1	SLED2	MLED1	MLED3	VBAT2	C2N	T2
	1	2	3	4	5	6	7

Total: 48ball

There is no Ball only in C3 for index.

BD6081GVW

H	T2	C1P	C2P	-	-	SDA	RESET	T3
G	C1N	-	-	VOUTM	TESTO1	SCL	RGB2CNT	VIO
F	CPGND	C2N	TEST1	VOUT	DGND	RGB1CNT	TESTO2	REG2MD
E	MLED3	MLED4	VBAT2	VBATCP	-	REG2EN	REGGND	-
D	MLED2	-	MLED1	-	-	REG1O	VBATREG	-
C	 (index)	BLGND	B2LED	-	-	TEST2	CREF	REG2O
B	SLED2	SLED1	R2LED	-	-	REFGND	-	VBAT1
A	T1	G2LED	RGBGND	B1LED	G1LED	R1LED	ISET	T4
	1	2	3	4	5	6	7	8

Total: 63ball

There is no Ball only in C1 for index.

“-“ means NC pin (Non connect to internal circuit)

● Package

BD6081GU

VCSP85H3 CSP small Package

SIZE : 3.90mm×3.90mm (A difference in public: X and Y, together, ± 0.1mm) height 1.0mm max

A ball pitch : 0.5mm

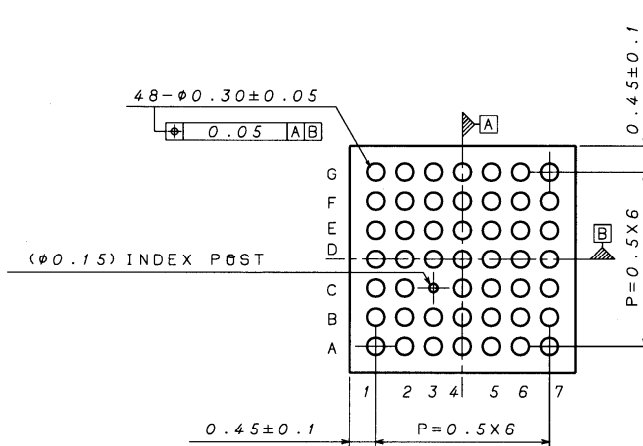
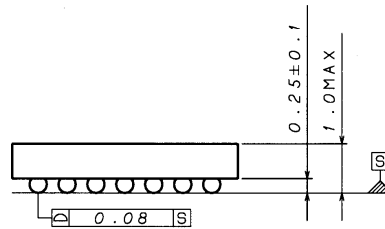
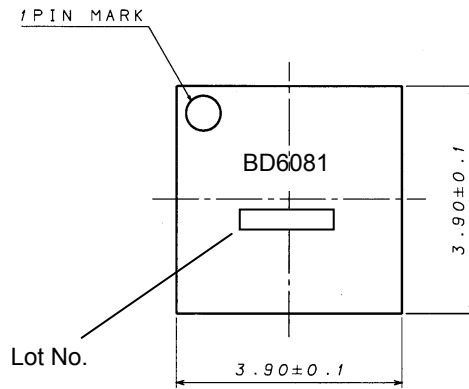

(UNIT : mm)

● Package

BD6081GVW

SBGA063W060

SIZE : 6.0mm×6.0mm(A difference in public: X and Y, together, ± 0.1mm) height 0.9mm max

A ball pitch : 0.65mm

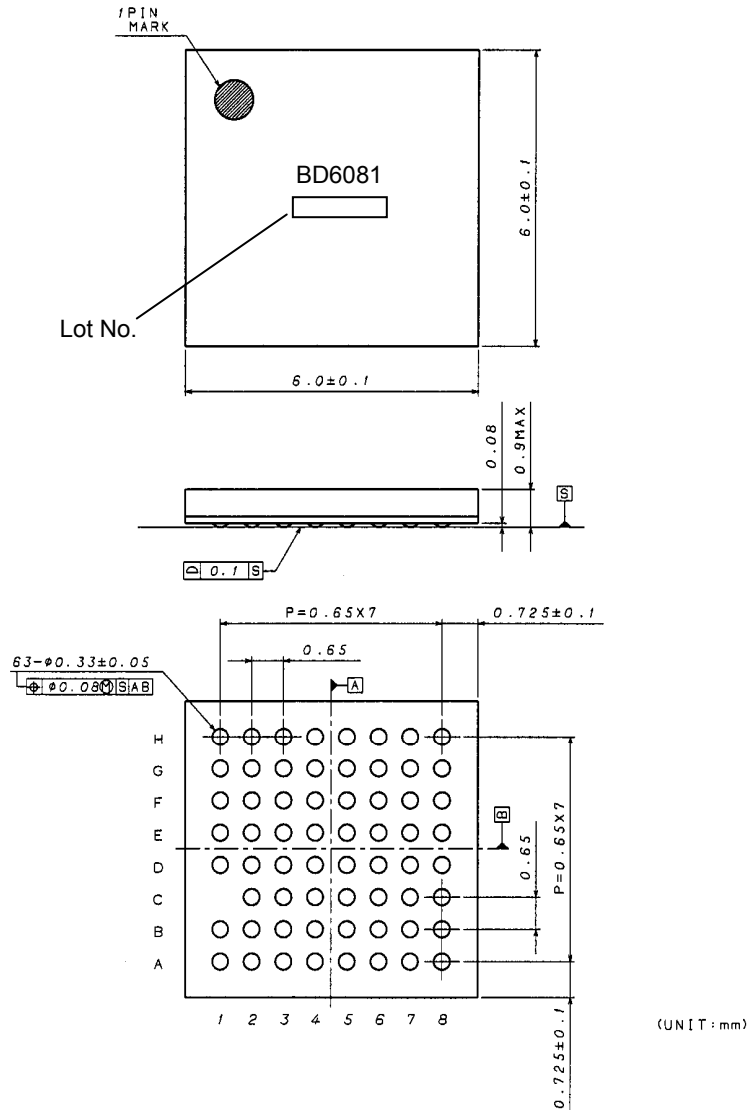

● Pin Functions

No	Pin No.		Pin Name	I/O	Input Level	ESD Diode		Functions	Equivalent circuit diagram
	BD6081GU	BD6081GVW				For Power	For Ground		
1	B7	E4	VBATCP	-	-	-	GND	Battery is connected	A
2	G2	B8	VBAT1	-	-	-	GND	Battery is connected	A
3	A5	E3	VBAT2	-	-	-	GND	Battery is connected	A
4	G4	D7	VBATREG	-	-	-	GND	Battery is connected	A
5	A1	A1	T1	-	-	-	GND	Test Pin (short to GND)	A
6	A7	H1	T2	-	-	-	GND	Test Pin (short to GND)	A
7	G7	H8	T3	-	-	VBAT	GND	Test Pin (short to GND)	J
8	G1	A8	T4	-	-	VBAT	GND	Test Pin (short to GND)	J
9	F3	C7	CREF	O	-	VBAT	GND	Reference voltage output	P
10	G6	G8	VIO	-	-	VBAT	GND	I/O voltage source is connected	C
11	F7	H7	RESET	I	VIO	VBAT	GND	Reset input (L: RESET, H: RESET cancel)	H
12	E6	H6	SDA	I	VIO	VBAT	GND	I ² C data input	I
13	D5	G6	SCL	I	VIO	VBAT	GND	I ² C clock input	H
14	B5	F1	CPGND	-	-	VBAT	-	Ground	B
15	F1	B6	REFGND	-	-	VBAT	-	Ground	B
16	G5	E7	REGGND	-	-	VBAT	-	Ground	B
17	B2	C2	BLGND	-	-	VBAT	-	Ground	B
18	D1	A3	RGBGND	-	-	VBAT	-	Ground	B
19	E7	F5	DGND	-	-	VBAT	-	Ground	B
20	B6	G1	C1N	I/O	-	VBAT	GND	Charge Pump capacitor is connected	F
21	C6	H2	C1P	I/O	-	-	GND	Charge Pump capacitor is connected	G
22	A6	F2	C2N	I/O	-	VBAT	GND	Charge Pump capacitor is connected	F
23	C7	H3	C2P	I/O	-	-	GND	Charge Pump capacitor is connected	G
24	D7	F4	VOUT	O	-	-	GND	Charge Pump output pin	A
25	D6	G4	VOUTM	O	-	-	GND	Charge Pump output pin output pin	A
26	E3	A7	ISET	I	-	VBAT	GND	LED standard current	O
27	F4	D6	REG1O	O	-	VBAT	GND	REG1 output pin	Q
28	G3	C8	REG2O	O	-	VBAT	GND	REG2 output pin	Q
29	A3	D3	MLED1	I	-	VBAT	GND	Main LCD Back Light LED is connected 1	D
30	B3	D1	MLED2	I	-	VBAT	GND	Main LCD Back Light LED is connected 2	D
31	A4	E1	MLED3	I	-	VBAT	GND	Main LCD Back Light LED is connected 3	D
32	B4	E2	MLED4	I	-	VBAT	GND	Main LCD Back Light LED is connected 4	D
33	B1	B2	SLED1	I	-	VBAT	GND	Sub LCD Back Light LED is connected 1	D
34	A2	B1	SLED2	I	-	VBAT	GND	Sub LCD Back Light LED is connected 2	D
35	F2	A6	R1LED	I	-	VBAT	GND	Red LED1 is connected	D
36	E1	A5	G1LED	I	-	VBAT	GND	Green LED1 is connected	D
37	E2	A4	B1LED	I	-	VBAT	GND	Blue LED1 is connected	D
38	D2	B3	R2LED	I	-	VBAT	GND	Red LED2 is connected	D
39	C1	A2	G2LED	I	-	VBAT	GND	Green LED2 is connected	D
40	C2	C3	B2LED	I	-	VBAT	GND	Blue LED2 is connected	D
41	F6	F6	RGB1CNT	I	VIO	VIO	GND	RGB1 LED external ON/OFF Synchronism Pin	K
42	E5	G7	RGB2CNT	I	VIO	VIO	GND	RGB2 LED external ON/OFF Synchronism Pin	K
43	E4	E6	REG2EN	I	(VBAT)	VBAT	GND	REG2 ON/OFF control Pin (L: OFF, H: ON)	L
44	F5	F8	REG2MD	I	(VBAT)	VBAT	GND	REG2 Mode control Pin (L: low current consumption, H: normal)	L
45	D3	F3	TESTI1	I	-	VBAT	GND	Test input pin 1 (short to GND)	H
46	D4	C6	TESTI2	I	-	VBAT	GND	Test input pin 2 (short to GND)	H
47	C5	G5	TESTO1	O	-	VBAT	GND	Test output pin 1 (OPEN)	M
48	C4	F7	TESTO2	O	-	VBAT	GND	Test output pin 2 (OPEN)	N
49 - 63	-	(Other)	NC	-	-	-	-	Non connect pin	-

※ The LED pin which isn't used is to short-circuit to the ground. But, the setup of a register concerned with LED that isn't used is prohibited.

Total: Functional 48Pin

48 balls (BD6081GU)

63 balls (BD6081GVW)

●Equivalent circuit diagram

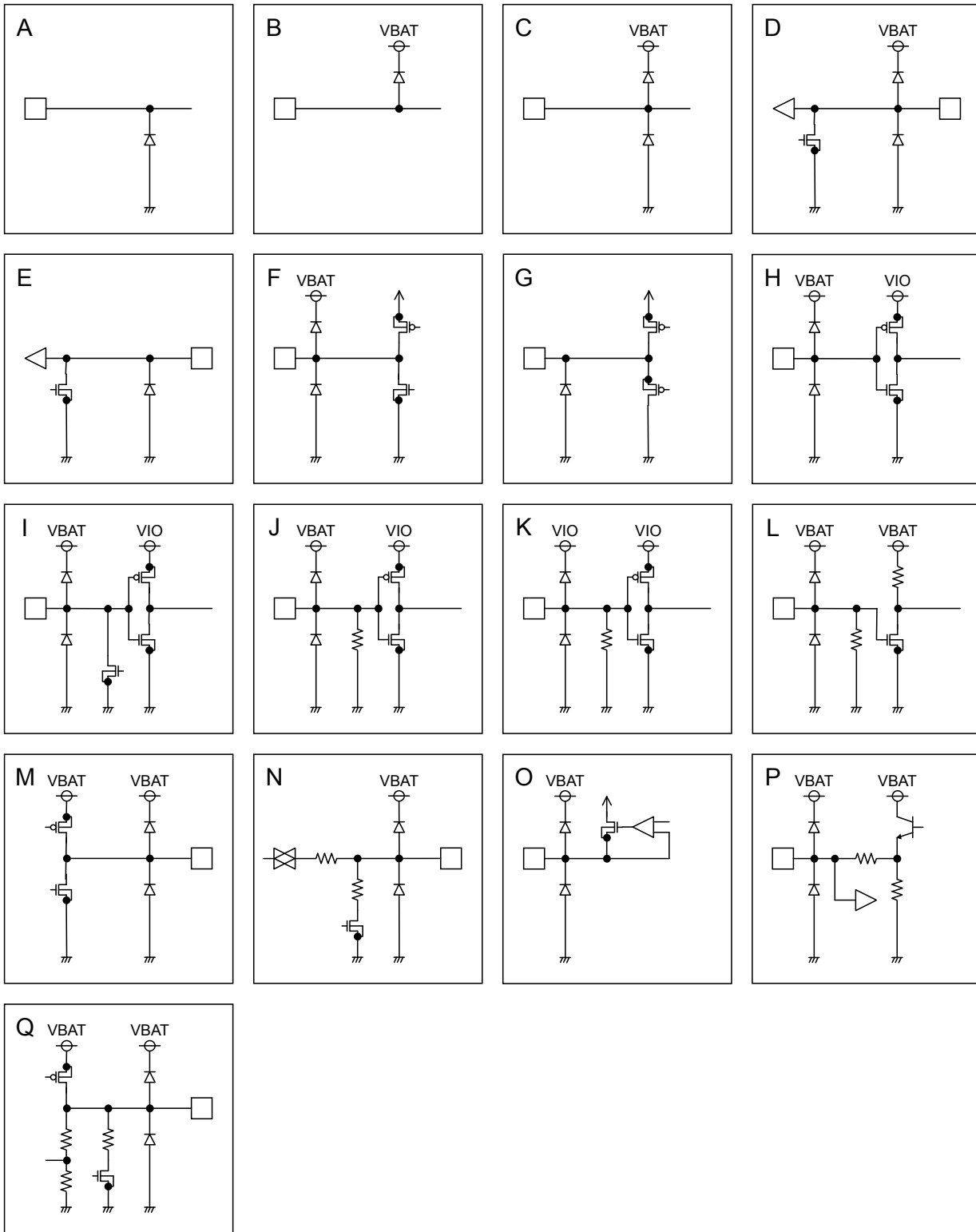

● I²C BUS format

The writing/reading operation is based on the I²C slave standard.

- Slave address

A7	A6	A5	A4	A3	A2	A1	W
1	1	1	0	1	1	0	0

- Bit Transfer

SCL transfers 1-bit data during H. SCL cannot change signal of SDA during H at the time of bit transfer. If SDA changes while SCL is H, START conditions or STOP conditions will occur and it will be interpreted as a control signal.

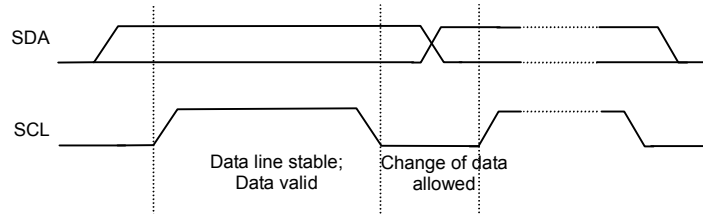

- START and STOP condition

When SDA and SCL are H, data is not transferred on the I²C- bus. This condition indicates, if SDA changes from H to L while SCL has been H, it will become START (S) conditions, and an access start, if SDA changes from L to H while SCL has been H, it will become STOP (P) conditions and an access end.

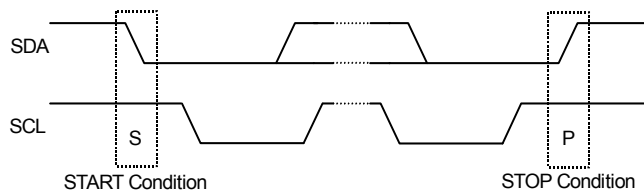

- Acknowledge

It transfers data 8 bits each after the occurrence of START condition. A transmitter opens SDA after transfer 8bits data, and a receiver returns the acknowledge signal by setting SDA to L.

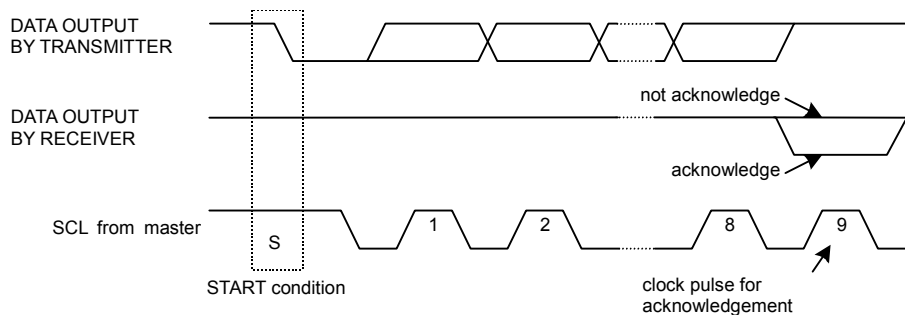

• Writing protocol

A register address is transferred by the next 1 byte that transferred the slave address and the write-in command. The 3rd byte writes data in the internal register written in by the 2nd byte, and after 4th byte or, the increment of register address is carried out automatically. However, when a register address turns into the last address (1Ah), it is set to 00h by the next transmission. After the transmission end, the increment of the address is carried out.

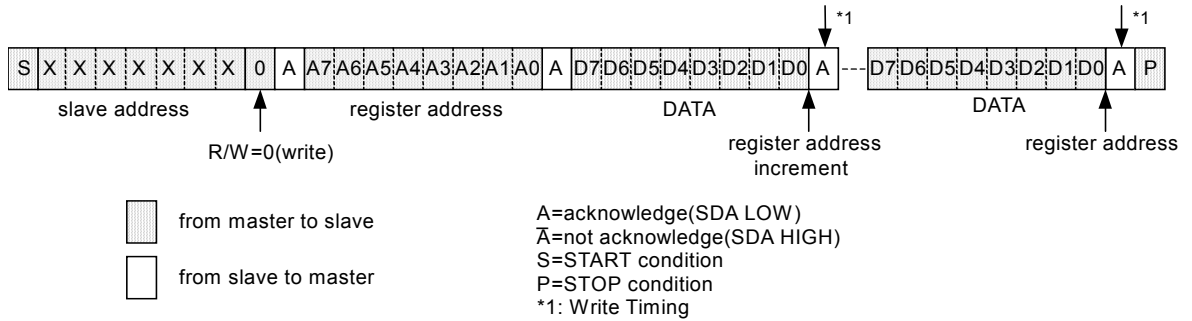

●Timing diagram

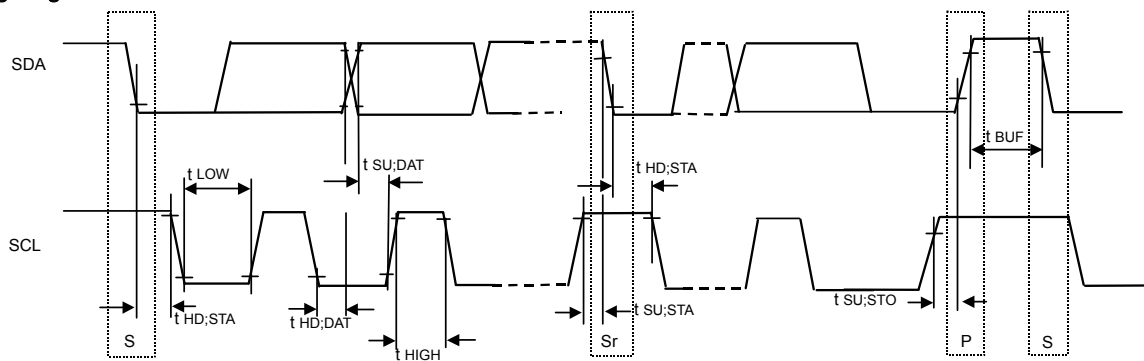

●Electrical Characteristics (Unless otherwise specified, Ta=25 °C, VBAT=3.6V, VIO=1.8V)

Parameter	Symbol	Standard-mode			Fast-mode			Unit
		Min.	Typ.	Max.	Min.	Typ.	Max.	
[I²C BUS format]								
SCL clock frequency	fSCL	0	-	100	0	-	400	kHz
LOW period of the SCL clock	tLOW	4.7	-	-	1.3	-	-	µs
HIGH period of the SCL clock	tHIGH	4.0	-	-	0.6	-	-	µs
Hold time (repeated) START condition After this period, the first clock is generated	tHD;STA	4.0	-	-	0.6	-	-	µs
Set-up time for a repeated START condition	tSU;STA	4.7	-	-	0.6	-	-	µs
Data hold time	tHD;DAT	0	-	3.45	0	-	0.9	µs
Data set-up time	tSU;DAT	250	-	-	100	-	-	ns
Set-up time for STOP condition	tSU;STO	4.0	-	-	0.6	-	-	µs
Bus free time between a STOP and START condition	tBUF	4.7	-	-	1.3	-	-	µs

● Register List

Address	Register data								Function
	D7	D6	D5	D4	D3	D2	D1	D0	
00h	-	-	-	-	-	-	-	SFTRST	Software reset
01h	-	-	REG2NML	REG2PD	-	-	-	REG1PD	Control LDO
02h	-	-	SLEDSSEL	SLEDEN	-	-	MLEDSEL	MLEDEN	Control Back Light
03h	-	-	-	IMLED4	IMLED3	IMLED2	IMLED1	IMLED0	Main Back Light current value
04h	-	-	-	ISLED4	ISLED3	ISLED2	ISLED1	ISLED0	Sub Back Light current value
05h	-	B2LEDMD	G2LEDMD	RGB2STA	-	B1LEDMD	G1LEDMD	RGB1STA	Control RGB1, RGB2 LED Setting GB LED connection
06h	RGB1MD1	RGB1MD0	B1LEDPL	G1LEDPL	R1LEDPL	B1LEDEN	G1LEDEN	R1LEDEN	Control RGB1 LED
07h	RGB1WT1TM3	RGB1WT1TM2	RGB1WT1TM1	RGB1WT1TM0	RGB1WT2TM3	RGB1WT2TM2	RGB1WT2TM1	RGB1WT2TM0	RGB1 ON time setting
08h	RGB1SL1 STEP3	RGB1SL1 STEP2	RGB1SL1 STEP1	RGB1SL1 STEP0	RGB1SL2 STEP3	RGB1SL2 STEP2	RGB1SL2 STEP1	RGB1SL2 STEP0	RGB1 slope 1step time setting
09h	-	-	-	-	-	RGB1SLNUM2	RGB1SLNUM1	RGB1SLNUM0	RGB1 slope step number setting
0Ah	-	-	I1R1LED5	I1R1LED4	I1R1LED3	I1R1LED2	I1R1LED1	I1R1LED0	R1 LED current value1
0Bh	-	-	IDLTR1LED5	IDLTR1LED4	IDLTR1LED3	IDLTR1LED2	IDLTR1LED1	IDLTR1LED0	Δ current value for R1 LED current step
0Ch	-	-	I1G1LED5	I1G1LED4	I1G1LED3	I1G1LED2	I1G1LED1	I1G1LED0	G1 LED current value1
0Dh	-	-	IDLTG1LED5	IDLTG1LED4	IDLTG1LED3	IDLTG1LED2	IDLTG1LED1	IDLTG1LED0	Δ current value for G1 LED current step
0Eh	-	-	I1B1LED5	I1B1LED4	I1B1LED3	I1B1LED2	I1B1LED1	I1B1LED0	B1 LED current value1
0Fh	-	-	IDLTB1LED5	IDLTB1LED4	IDLTB1LED3	IDLTB1LED2	IDLTB1LED1	IDLTB1LED0	Δ current value for B1 LED current step
10h	RGB2MD1	RGB2MD0	B2LEDPL	G2LEDPL	R2LEDPL	B2LEDEN	G2LEDEN	R2LEDEN	Control RGB2 LED
11h	RGB2WT1TM3	RGB2WT1TM2	RGB2WT1TM1	RGB2WT1TM0	RGB2WT2TM3	RGB2WT2TM2	RGB2WT2TM1	RGB2WT2TM0	RGB2 ON time setting
12h	RGB2SL1 STEP3	RGB2SL1 STEP2	RGB2SL1 STEP1	RGB2SL1 STEP0	RGB2SL2 STEP3	RGB2SL2 STEP2	RGB2SL2 STEP1	RGB2SL2 STEP0	RGB2 slope 1step time setting
13h	-	-	-	-	-	RGB2SLNUM2	RGB2SLNUM1	RGB2SLNUM0	RGB2 slope step number setting
14h	-	-	I1R2LED5	I1R2LED4	I1R2LED3	I1R2LED2	I1R2LED1	I1R2LED0	R2 LED current value1
15h	-	-	IDLTR2LED5	IDLTR2LED4	IDLTR2LED3	IDLTR2LED2	IDLTR2LED1	IDLTR2LED0	Δ current value for R2 LED current step
16h	-	-	I1G2LED5	I1G2LED4	I1G2LED3	I1G2LED2	I1G2LED1	I1G2LED0	G2 LED current value1
17h	-	-	IDLTG2LED5	IDLTG2LED4	IDLTG2LED3	IDLTG2LED2	IDLTG2LED1	IDLTG2LED0	Δ current value for G2 LED current step
18h	-	-	I1B2LED5	I1B2LED4	I1B2LED3	I1B2LED2	I1B2LED1	I1B2LED0	B2 LED current value1
19h	-	-	IDLTB2LED5	IDLTB2LED4	IDLTB2LED3	IDLTB2LED2	IDLTB2LED1	IDLTB2LED0	Δ current value for B2 LED current step
1Ah	-	-	-	-	-	-	RGB2MEL	RGB1MEL	RGB1, RGB2 LED external ON/OFF control
1Dh	Reserved								For test
1Eh	Reserved								For test
1Fh	Reserved								For test

Input "0" for "-".

Prohibit to accessing the address that isn't mentioned and the register for test.

●Register Map

Address 00h <Software reset>

BIT	Name	Initial	Function	
			0	1
D7	-	-	-	-
D6	-	-	-	-
D5	-	-	-	-
D4	-	-	-	-
D3	-	-	-	-
D2	-	-	-	-
D1	-	-	-	-
D0	SFTRST	0	Reset cancel	Reset

Address 01h <Control LDO>

BIT	Name	Initial	Function	
			0	1
D7	-	-	-	-
D6	-	-	-	-
D5	REG2NML	0	REG2 low current consumption mode	REG2 normal mode
D4	REG2PD	0	REG2 power OFF	REG2 power ON
D3	-	-	-	-
D2	-	-	-	-
D1	-	-	-	-
D0	REG1PD	0	REG1 power OFF	REG1 power ON

Address 02h <Control Back Light>

BIT	Name	Initial	Function	
			0	1
D7	-	-	-	-
D6	-	-	-	-
D5	SLEDSEL	0	2 lights ON (SLED1~2)	1 lights ON (SLED1)
D4	SLEDEN	0	Sub Back Light OFF	Sub Back Light ON
D3	-	-	-	-
D2	-	-	-	-
D1	MLEDSEL	0	4 lights ON (MLED1~4)	3 lights ON (MLED1~3)
D0	MLEDEN	0	Main Back Light OFF	Main Back Light ON

Address 03h <Main Back Light current value>

BIT	Name	Initial	Function																																																												
			0	1																																																											
D7	-	-	-	-																																																											
D6	-	-	-	-																																																											
D5	-	-	-	-																																																											
D4	IMLED4	0	<table border="1"> <thead> <tr> <th>IMLED4</th> <th>IMLED3</th> <th>IMLED2</th> <th>IMLED1</th> <th>IMLED0</th> <th>Current value</th> </tr> </thead> <tbody> <tr> <td>0</td> <td>0</td> <td>0</td> <td>0</td> <td>0</td> <td>1mA</td> </tr> <tr> <td>0</td> <td>0</td> <td>0</td> <td>0</td> <td>1</td> <td>2mA</td> </tr> <tr> <td>0</td> <td>0</td> <td>0</td> <td>1</td> <td>0</td> <td>3mA</td> </tr> <tr> <td>.</td> <td>.</td> <td>.</td> <td>.</td> <td>.</td> <td rowspan="3">1mA Step</td> </tr> <tr> <td>.</td> <td>.</td> <td>.</td> <td>.</td> <td>.</td> </tr> <tr> <td>.</td> <td>.</td> <td>.</td> <td>.</td> <td>.</td> </tr> <tr> <td>1</td> <td>1</td> <td>1</td> <td>0</td> <td>1</td> <td>30mA</td> </tr> <tr> <td>1</td> <td>1</td> <td>1</td> <td>1</td> <td>0</td> <td>31mA</td> </tr> <tr> <td>1</td> <td>1</td> <td>1</td> <td>1</td> <td>1</td> <td>32mA</td> </tr> </tbody> </table> <p>When 120kΩ is connected to ISET pin.</p>			IMLED4	IMLED3	IMLED2	IMLED1	IMLED0	Current value	0	0	0	0	0	1mA	0	0	0	0	1	2mA	0	0	0	1	0	3mA	1mA Step	1	1	1	0	1	30mA	1	1	1	1	0	31mA	1	1	1	1	1	32mA
IMLED4	IMLED3	IMLED2				IMLED1	IMLED0	Current value																																																							
0	0	0				0	0	1mA																																																							
0	0	0				0	1	2mA																																																							
0	0	0				1	0	3mA																																																							
.	1mA Step																																																							
.																																																								
.																																																								
1	1	1	0	1	30mA																																																										
1	1	1	1	0	31mA																																																										
1	1	1	1	1	32mA																																																										
D3	IMLED3	0																																																													
D2	IMLED2	0																																																													
D1	IMLED1	0																																																													
D0	IMLED0	0																																																													

Address 04h <Sub Back Light current value>

BIT	Name	Initial	Function																																																												
			0	1																																																											
D7	-	-	-	-																																																											
D6	-	-	-	-																																																											
D5	-	-	-	-																																																											
D4	ISLED4	0	<table border="1"> <thead> <tr> <th>ISLED4</th> <th>ISLED3</th> <th>ISLED2</th> <th>ISLED1</th> <th>ISLED0</th> <th>Current value</th> </tr> </thead> <tbody> <tr> <td>0</td> <td>0</td> <td>0</td> <td>0</td> <td>0</td> <td>1mA</td> </tr> <tr> <td>0</td> <td>0</td> <td>0</td> <td>0</td> <td>1</td> <td>2mA</td> </tr> <tr> <td>0</td> <td>0</td> <td>0</td> <td>1</td> <td>0</td> <td>3mA</td> </tr> <tr> <td>.</td> <td>.</td> <td>.</td> <td>.</td> <td>.</td> <td rowspan="3">1mA Step</td> </tr> <tr> <td>.</td> <td>.</td> <td>.</td> <td>.</td> <td>.</td> </tr> <tr> <td>.</td> <td>.</td> <td>.</td> <td>.</td> <td>.</td> </tr> <tr> <td>1</td> <td>1</td> <td>1</td> <td>0</td> <td>1</td> <td>30mA</td> </tr> <tr> <td>1</td> <td>1</td> <td>1</td> <td>1</td> <td>0</td> <td>31mA</td> </tr> <tr> <td>1</td> <td>1</td> <td>1</td> <td>1</td> <td>1</td> <td>32mA</td> </tr> </tbody> </table> <p>When 120kΩ is connected to ISET pin.</p>			ISLED4	ISLED3	ISLED2	ISLED1	ISLED0	Current value	0	0	0	0	0	1mA	0	0	0	0	1	2mA	0	0	0	1	0	3mA	1mA Step	1	1	1	0	1	30mA	1	1	1	1	0	31mA	1	1	1	1	1	32mA
ISLED4	ISLED3	ISLED2				ISLED1	ISLED0	Current value																																																							
0	0	0				0	0	1mA																																																							
0	0	0				0	1	2mA																																																							
0	0	0				1	0	3mA																																																							
.	1mA Step																																																							
.																																																								
.																																																								
1	1	1	0	1	30mA																																																										
1	1	1	1	0	31mA																																																										
1	1	1	1	1	32mA																																																										
D3	ISLED3	0																																																													
D2	ISLED2	0																																																													
D1	ISLED1	0																																																													
D0	ISLED0	0																																																													

Address 05h <Control RGB1, RGB2 LED, Setting GB LED connection>

BIT	Name	Initial	Function	
			0	1
D7	-	-	-	-
D6	B2LEDMD	0	B2LED connection =VBAT	B2LED connection =VOUT
D5	G2LEDMD	0	G2LED connection =VBAT	G2LED connection =VOUT
D4	RGB2STA	0	RGB2 LED Lighting stop	RGB2 LED Lighting start
D3	-	-	-	-
D2	B1LEDMD	0	B1LED connection =VBAT	B1LED connection =VOUT
D1	G1LEDMD	0	G1LED connection =VBAT	G1LED connection =VOUT
D0	RGB1STA	0	RGB1 LED Lighting stop	RGB1 LED Lighting start

Address 06h <Control RGB1 LED>

BIT	Name	Initial	Function	
			0	1
D7	RGB1MD1	0	Refer to the following	Refer to the following
D6	RGB1MD0	0	Refer to the following	Refer to the following
D5	B1LEDPL	0	Refer to the following	Refer to the following
D4	G1LEDPL	0	Refer to the following	Refer to the following
D3	R1LEDPL	0	Refer to the following	Refer to the following
D2	B1LEDEN	0	B1 LED OFF	B1 LED ON
D1	G1LEDEN	0	G1 LED OFF	G1 LED ON
D0	R1LEDEN	0	R1 LED OFF	R1 LED ON

RGB1MD1	RGB1MD0	*1LEDPL	Mode
0	0	0 / 1	Normal 1
0	1	0 / 1	Normal 2
1	0	0	Blink 1
		1	Blink 2
1	1	0	Slope 1
		1	Slope 2

*1LEDPL : R1LEDPL, G1LEDPL, B1LEDPL is shown.

Address 07h <RGB1 ON time setting>

BIT	Name	Initial	Function																																								
D7	RGB1WT1TM3	0	<table border="1"> <thead> <tr> <th>RGB1WT1TM3</th> <th>RGB1WT1TM2</th> <th>RGB1WT1TM1</th> <th>RGB1WT1TM0</th> <th>Current light time</th> </tr> </thead> <tbody> <tr> <td>0</td> <td>0</td> <td>0</td> <td>0</td> <td>0.256s</td> </tr> <tr> <td>0</td> <td>0</td> <td>0</td> <td>1</td> <td>0.512s</td> </tr> <tr> <td>.</td> <td>.</td> <td>.</td> <td>.</td> <td>0.256s</td> </tr> <tr> <td>.</td> <td>.</td> <td>.</td> <td>.</td> <td>Step</td> </tr> <tr> <td>1</td> <td>1</td> <td>0</td> <td>1</td> <td>3.584s</td> </tr> <tr> <td>1</td> <td>1</td> <td>1</td> <td>0</td> <td>3.84s</td> </tr> <tr> <td>1</td> <td>1</td> <td>1</td> <td>1</td> <td>4.096s</td> </tr> </tbody> </table> <p>Lighting time depends on internal OSC frequency.</p>	RGB1WT1TM3	RGB1WT1TM2	RGB1WT1TM1	RGB1WT1TM0	Current light time	0	0	0	0	0.256s	0	0	0	1	0.512s	0.256s	Step	1	1	0	1	3.584s	1	1	1	0	3.84s	1	1	1	1	4.096s
RGB1WT1TM3	RGB1WT1TM2	RGB1WT1TM1		RGB1WT1TM0	Current light time																																						
0	0	0		0	0.256s																																						
0	0	0		1	0.512s																																						
.	.	.		.	0.256s																																						
.	.	.		.	Step																																						
1	1	0		1	3.584s																																						
1	1	1		0	3.84s																																						
1	1	1		1	4.096s																																						
D6	RGB1WT1TM2	0																																									
D5	RGB1WT1TM1	0																																									
D4	RGB1WT1TM0	0																																									
D3	RGB1WT2TM3	0	<table border="1"> <thead> <tr> <th>RGB1WT2TM3</th> <th>RGB1WT2TM2</th> <th>RGB1WT2TM1</th> <th>RGB1WT2TM0</th> <th>Current light time</th> </tr> </thead> <tbody> <tr> <td>0</td> <td>0</td> <td>0</td> <td>0</td> <td>0.256s</td> </tr> <tr> <td>0</td> <td>0</td> <td>0</td> <td>1</td> <td>0.512s</td> </tr> <tr> <td>.</td> <td>.</td> <td>.</td> <td>.</td> <td>0.256s</td> </tr> <tr> <td>.</td> <td>.</td> <td>.</td> <td>.</td> <td>Step</td> </tr> <tr> <td>1</td> <td>1</td> <td>0</td> <td>1</td> <td>3.584s</td> </tr> <tr> <td>1</td> <td>1</td> <td>1</td> <td>0</td> <td>3.84s</td> </tr> <tr> <td>1</td> <td>1</td> <td>1</td> <td>1</td> <td>4.096s</td> </tr> </tbody> </table> <p>Lighting time depends on internal OSC frequency.</p>	RGB1WT2TM3	RGB1WT2TM2	RGB1WT2TM1	RGB1WT2TM0	Current light time	0	0	0	0	0.256s	0	0	0	1	0.512s	0.256s	Step	1	1	0	1	3.584s	1	1	1	0	3.84s	1	1	1	1	4.096s
RGB1WT2TM3	RGB1WT2TM2	RGB1WT2TM1		RGB1WT2TM0	Current light time																																						
0	0	0		0	0.256s																																						
0	0	0		1	0.512s																																						
.	.	.		.	0.256s																																						
.	.	.		.	Step																																						
1	1	0		1	3.584s																																						
1	1	1		0	3.84s																																						
1	1	1	1	4.096s																																							
D2	RGB1WT2TM2	0																																									
D1	RGB1WT2TM1	0																																									
D0	RGB1WT2TM0	0																																									

Address 08h <RGB1 slope 1step time setting>

BIT	Name	Initial	Function																																			
			RGB1SL1 STEP3	RGB1SL1 STEP2	RGB1SL1 STEP1	RGB1SL1 STEP0	Current light time																															
D7	RGB1SL1STEP3	0	<table border="1"> <tr><td>0</td><td>0</td><td>0</td><td>0</td><td>4ms</td></tr> <tr><td>0</td><td>0</td><td>0</td><td>1</td><td>8ms</td></tr> <tr><td>.</td><td>.</td><td>.</td><td>.</td><td>4ms Step</td></tr> <tr><td>.</td><td>.</td><td>.</td><td>.</td><td></td></tr> <tr><td>1</td><td>1</td><td>0</td><td>1</td><td>56ms</td></tr> <tr><td>1</td><td>1</td><td>1</td><td>0</td><td>60ms</td></tr> <tr><td>1</td><td>1</td><td>1</td><td>1</td><td>64ms</td></tr> </table> <p>Lighting time depends on internal OSC frequency.</p>	0	0	0	0	4ms	0	0	0	1	8ms	4ms Step		1	1	0	1	56ms	1	1	1	0	60ms	1	1	1	1	64ms
0	0	0		0	4ms																																	
0	0	0		1	8ms																																	
.	.	.		.	4ms Step																																	
.	.	.		.																																		
1	1	0		1	56ms																																	
1	1	1		0	60ms																																	
1	1	1		1	64ms																																	
D6	RGB1SL1STEP2	0																																				
D5	RGB1SL1STEP1	0																																				
D4	RGB1SL1STEP0	0																																				
D3	RGB1SL2STEP3	0	<table border="1"> <tr><td>0</td><td>0</td><td>0</td><td>0</td><td>4ms</td></tr> <tr><td>0</td><td>0</td><td>0</td><td>1</td><td>8ms</td></tr> <tr><td>.</td><td>.</td><td>.</td><td>.</td><td>4ms Step</td></tr> <tr><td>.</td><td>.</td><td>.</td><td>.</td><td></td></tr> <tr><td>1</td><td>1</td><td>0</td><td>1</td><td>56ms</td></tr> <tr><td>1</td><td>1</td><td>1</td><td>0</td><td>60ms</td></tr> <tr><td>1</td><td>1</td><td>1</td><td>1</td><td>64ms</td></tr> </table> <p>Lighting time depends on internal OSC frequency.</p>	0	0	0	0	4ms	0	0	0	1	8ms	4ms Step		1	1	0	1	56ms	1	1	1	0	60ms	1	1	1	1	64ms
0	0	0		0	4ms																																	
0	0	0		1	8ms																																	
.	.	.		.	4ms Step																																	
.	.	.		.																																		
1	1	0		1	56ms																																	
1	1	1		0	60ms																																	
1	1	1		1	64ms																																	
D2	RGB1SL2STEP2	0																																				
D1	RGB1SL2STEP1	0																																				
D0	RGB1SL2STEP0	0																																				

Address 09h <RGB1 slope step number setting>

BIT	Name	Initial	Function																																				
			0		1																																		
D7	-	-	-	-	-	-																																	
D6	-	-	-	-	-	-																																	
D5	-	-	-	-	-	-																																	
D4	-	-	-	-	-	-																																	
D3	-	-																																					
D2	RGB1SLNUM2	0	<table border="1"> <tr><th>RGB1SLNUM2</th><th>RGB1SLNUM1</th><th>RGB1SLNUM0</th><th>Step</th></tr> <tr><td>0</td><td>0</td><td>0</td><td>1 Step</td></tr> <tr><td>0</td><td>0</td><td>1</td><td>2 Step</td></tr> <tr><td>0</td><td>1</td><td>0</td><td>4 Step</td></tr> <tr><td>0</td><td>1</td><td>1</td><td>8 Step</td></tr> <tr><td>1</td><td>0</td><td>0</td><td>16 Step</td></tr> <tr><td>1</td><td>0</td><td>1</td><td>32 Step</td></tr> <tr><td>1</td><td>1</td><td>0</td><td>64 Step</td></tr> <tr><td>1</td><td>1</td><td>1</td><td>(Prohibited)</td></tr> </table>	RGB1SLNUM2	RGB1SLNUM1	RGB1SLNUM0	Step	0	0	0	1 Step	0	0	1	2 Step	0	1	0	4 Step	0	1	1	8 Step	1	0	0	16 Step	1	0	1	32 Step	1	1	0	64 Step	1	1	1	(Prohibited)
RGB1SLNUM2	RGB1SLNUM1	RGB1SLNUM0		Step																																			
0	0	0		1 Step																																			
0	0	1		2 Step																																			
0	1	0		4 Step																																			
0	1	1		8 Step																																			
1	0	0		16 Step																																			
1	0	1		32 Step																																			
1	1	0		64 Step																																			
1	1	1		(Prohibited)																																			
D1	RGB1SLNUM1	0																																					
D0	RGB1SLNUM0	0																																					

Address 0Ah <R1 LED current value 1>

BIT	Name	Initial	Function						
			0		1				
D7	-	-	-		-				
D6	-	-	-		-				
D5	I1R1LED5	0							
D4	I1R1LED4	0	I1R1 LED5	I1R1 LED4	I1R1 LED3	I1R1 LED2	I1R1 LED1	I1R1 LED0	Current value
D3	I1R1LED3	0	0	0	0	0	0	0	0mA
D2	I1R1LED2	0	0	0	0	0	0	1	0.5mA
D1	I1R1LED1	0	0	0	0	0	1	0	1mA
D0	I1R1LED0	0	0.5mA Step
			
			
			
			1	1	1	1	0	1	30.5mA
			1	1	1	1	1	0	31mA
			1	1	1	1	1	1	31.5mA

When 120kΩ is connected to ISET pin.

Address 0Bh <Δ current value for R1 LED current step>

BIT	Name	Initial	Function						
			0		1				
D7	-	-	-		-				
D6	-	-	-		-				
D5	IDLTR1LED5	0							
D4	IDLTR1LED4	0	IDLTR1 LED5	IDLTR1 LED4	IDLTR1 LED3	IDLTR1 LED2	IDLTR1 LED1	IDLTR1 LED0	Current value
D3	IDLTR1LED3	0	0	0	0	0	0	0	0mA
D2	IDLTR1LED2	0	0	0	0	0	0	1	0.5mA
D1	IDLTR1LED1	0	0	0	0	0	1	0	1mA
D0	IDLTR1LED0	0	0.5mA Step
			
			
			
			1	1	1	1	0	1	30.5mA
			1	1	1	1	1	0	31mA
			1	1	1	1	1	1	31.5mA

When 120kΩ is connected to ISET pin.

Address 0Ch <G1 LED current value1>

BIT	Name	Initial	Function						
			0		1				
D7	-	-	-		-				
D6	-	-	-		-				
D5	I1G1LED5	0							
D4	I1G1LED4	0	I1G1 LED5	I1G1 LED4	I1G1 LED3	I1G1 LED2	I1G1 LED1	I1G1 LED0	Current value
D3	I1G1LED3	0	0	0	0	0	0	0	0mA
D2	I1G1LED2	0	0	0	0	0	0	1	0.5mA
D1	I1G1LED1	0	0	0	0	0	1	0	1mA
D0	I1G1LED0	0	0.5mA Step
			
			
			
			1	1	1	1	0	1	30.5mA
			1	1	1	1	1	0	31mA
			1	1	1	1	1	1	31.5mA

When 120kΩ is connected to ISET pin.

Address 0Dh <Δ current value for G1 LED current step >

BIT	Name	Initial	Function						
			0		1				
D7	-	-	-		-				
D6	-	-	-		-				
D5	IDLTG1LED5	0							
D4	IDLTG1LED4	0	IDLTG1 LED5	IDLTG1 LED4	IDLTG1 LED3	IDLTG1 LED2	IDLTG1 LED1	IDLTG1 LED0	Current value
D3	IDLTG1LED3	0	0	0	0	0	0	0	0mA
D2	IDLTG1LED2	0	0	0	0	0	0	1	0.5mA
D1	IDLTG1LED1	0	0	0	0	0	1	0	1mA
D0	IDLTG1LED0	0	0.5mA Step
			
			
			
			1	1	1	1	0	1	30.5mA
			1	1	1	1	1	0	31mA
			1	1	1	1	1	1	31.5mA

When 120kΩ is connected to ISET pin.

Address 0Eh <B1 LED Current value1>

BIT	Name	Initial	Function																																																																																					
			0		1																																																																																			
D7	-	-	-		-																																																																																			
D6	-	-	-		-																																																																																			
D5	I1B1LED5	0	<table border="1"> <thead> <tr> <th>I1B1 LED5</th> <th>I1B1 LED4</th> <th>I1B1 LED3</th> <th>I1B1 LED2</th> <th>I1B1 LED1</th> <th>I1B1 LED0</th> <th>Current value</th> </tr> </thead> <tbody> <tr> <td>0</td> <td>0</td> <td>0</td> <td>0</td> <td>0</td> <td>0</td> <td>0mA</td> </tr> <tr> <td>0</td> <td>0</td> <td>0</td> <td>0</td> <td>0</td> <td>1</td> <td>0.5mA</td> </tr> <tr> <td>0</td> <td>0</td> <td>0</td> <td>0</td> <td>1</td> <td>0</td> <td>1mA</td> </tr> <tr> <td>.</td> <td>.</td> <td>.</td> <td>.</td> <td>.</td> <td>.</td> <td rowspan="4">0.5mA Step</td> </tr> <tr> <td>.</td> <td>.</td> <td>.</td> <td>.</td> <td>.</td> <td>.</td> </tr> <tr> <td>.</td> <td>.</td> <td>.</td> <td>.</td> <td>.</td> <td>.</td> </tr> <tr> <td>.</td> <td>.</td> <td>.</td> <td>.</td> <td>.</td> <td>.</td> </tr> <tr> <td></td> <td></td> <td></td> <td>1</td> <td>1</td> <td>1</td> <td>0</td> <td>1</td> <td>30.5mA</td> </tr> <tr> <td></td> <td></td> <td></td> <td>1</td> <td>1</td> <td>1</td> <td>1</td> <td>1</td> <td>0</td> <td>31mA</td> </tr> <tr> <td></td> <td></td> <td></td> <td>1</td> <td>1</td> <td>1</td> <td>1</td> <td>1</td> <td>1</td> <td>31.5mA</td> </tr> </tbody> </table>				I1B1 LED5	I1B1 LED4	I1B1 LED3	I1B1 LED2	I1B1 LED1	I1B1 LED0	Current value	0	0	0	0	0	0	0mA	0	0	0	0	0	1	0.5mA	0	0	0	0	1	0	1mA	0.5mA Step				1	1	1	0	1	30.5mA				1	1	1	1	1	0	31mA				1	1	1	1	1	1	31.5mA
I1B1 LED5	I1B1 LED4	I1B1 LED3					I1B1 LED2	I1B1 LED1	I1B1 LED0	Current value																																																																														
0	0	0					0	0	0	0mA																																																																														
0	0	0					0	0	1	0.5mA																																																																														
0	0	0					0	1	0	1mA																																																																														
.	0.5mA Step																																																																														
.																																																																															
.																																																																															
.																																																																															
							1	1	1	0	1	30.5mA																																																																												
			1	1	1	1	1	0	31mA																																																																															
			1	1	1	1	1	1	31.5mA																																																																															
D4	I1B1LED4	0																																																																																						
D3	I1B1LED3	0																																																																																						
D2	I1B1LED2	0																																																																																						
D1	I1B1LED1	0																																																																																						
D0	I1B1LED0	0																																																																																						

When 120kΩ is connected to ISET pin.

Address 0Fh <Δ current value for B1 LED current step >

BIT	Name	Initial	Function																																																																																						
			0		1																																																																																				
D7	-	-	-		-																																																																																				
D6	-	-	-		-																																																																																				
D5	IDLTB1LED5	0	<table border="1"> <thead> <tr> <th>IDLTB1 LED5</th> <th>IDLTB1 LED4</th> <th>IDLTB1 LED3</th> <th>IDLTB1 LED2</th> <th>IDLTB1 LED1</th> <th>IDLTB1 LED0</th> <th>Current value</th> </tr> </thead> <tbody> <tr> <td>0</td> <td>0</td> <td>0</td> <td>0</td> <td>0</td> <td>0</td> <td>0mA</td> </tr> <tr> <td>0</td> <td>0</td> <td>0</td> <td>0</td> <td>0</td> <td>1</td> <td>0.5mA</td> </tr> <tr> <td>0</td> <td>0</td> <td>0</td> <td>0</td> <td>1</td> <td>0</td> <td>1mA</td> </tr> <tr> <td>.</td> <td>.</td> <td>.</td> <td>.</td> <td>.</td> <td>.</td> <td rowspan="4">0.5mA Step</td> </tr> <tr> <td>.</td> <td>.</td> <td>.</td> <td>.</td> <td>.</td> <td>.</td> </tr> <tr> <td>.</td> <td>.</td> <td>.</td> <td>.</td> <td>.</td> <td>.</td> </tr> <tr> <td>.</td> <td>.</td> <td>.</td> <td>.</td> <td>.</td> <td>.</td> </tr> <tr> <td></td> <td></td> <td></td> <td>1</td> <td>1</td> <td>1</td> <td>1</td> <td>0</td> <td>1</td> <td>30.5mA</td> </tr> <tr> <td></td> <td></td> <td></td> <td>1</td> <td>1</td> <td>1</td> <td>1</td> <td>1</td> <td>0</td> <td>31mA</td> </tr> <tr> <td></td> <td></td> <td></td> <td>1</td> <td>1</td> <td>1</td> <td>1</td> <td>1</td> <td>1</td> <td>31.5mA</td> </tr> </tbody> </table>				IDLTB1 LED5	IDLTB1 LED4	IDLTB1 LED3	IDLTB1 LED2	IDLTB1 LED1	IDLTB1 LED0	Current value	0	0	0	0	0	0	0mA	0	0	0	0	0	1	0.5mA	0	0	0	0	1	0	1mA	0.5mA Step				1	1	1	1	0	1	30.5mA				1	1	1	1	1	0	31mA				1	1	1	1	1	1	31.5mA
IDLTB1 LED5	IDLTB1 LED4	IDLTB1 LED3					IDLTB1 LED2	IDLTB1 LED1	IDLTB1 LED0	Current value																																																																															
0	0	0					0	0	0	0mA																																																																															
0	0	0					0	0	1	0.5mA																																																																															
0	0	0					0	1	0	1mA																																																																															
.	0.5mA Step																																																																															
.																																																																																
.																																																																																
.																																																																																
							1	1	1	1	0	1	30.5mA																																																																												
			1	1	1	1	1	0	31mA																																																																																
			1	1	1	1	1	1	31.5mA																																																																																
D4	IDLTB1LED4	0																																																																																							
D3	IDLTB1LED3	0																																																																																							
D2	IDLTB1LED2	0																																																																																							
D1	IDLTB1LED1	0																																																																																							
D0	IDLTB1LED0	0																																																																																							

When 120kΩ is connected to ISET pin.

Address 10h <Control RGB2 LED>

BIT	Name	Initial	Function	
			0	1
D7	RGB2MD1	0	Refer to following	Refer to following
D6	RGB2MD0	0	Refer to following	Refer to following
D5	B2LEDPL	0	Refer to following	Refer to following
D4	G2LEDPL	0	Refer to following	Refer to following
D3	R2LEDPL	0	Refer to following	Refer to following
D2	B2LEDEN	0	B2 LED OFF	B2 LED ON
D1	G2LEDEN	0	G2 LED OFF	G2 LED ON
D0	R2LEDEN	0	R2 LED OFF	R2 LED ON

RGB2MD1	RGB2MD0	*2LEDPL	Mode
0	0	0 / 1	Normal 1
0	1	0 / 1	Normal 2
1	0	0	Blink 1
		1	Blink 2
1	1	0	Slope 1
		1	Slope 2

*2LEDPL : R2LEDPL, G2LEDPL, B2LEDPL is shown.

Address 11h <RGB2 ON time setting>

BIT	Name	Initial	Function																																			
D7	RGB2WT1TM3	0	<table border="1"> <thead> <tr> <th>RGB2WT1 TM3</th> <th>RGB2WT1 TM2</th> <th>RGB2WT1 TM1</th> <th>RGB2WT1 TM0</th> <th>Current ON time setting</th> </tr> </thead> <tbody> <tr> <td>0</td> <td>0</td> <td>0</td> <td>0</td> <td>0.256s</td> </tr> <tr> <td>0</td> <td>0</td> <td>0</td> <td>1</td> <td>0.512s</td> </tr> <tr> <td>.</td> <td>.</td> <td>.</td> <td>.</td> <td>0.256s Step</td> </tr> <tr> <td>1</td> <td>1</td> <td>0</td> <td>1</td> <td>3.584s</td> </tr> <tr> <td>1</td> <td>1</td> <td>1</td> <td>0</td> <td>3.845s</td> </tr> <tr> <td>1</td> <td>1</td> <td>1</td> <td>1</td> <td>4.096s</td> </tr> </tbody> </table> <p>Lighting time depends on internal OSC frequency.</p>	RGB2WT1 TM3	RGB2WT1 TM2	RGB2WT1 TM1	RGB2WT1 TM0	Current ON time setting	0	0	0	0	0.256s	0	0	0	1	0.512s	0.256s Step	1	1	0	1	3.584s	1	1	1	0	3.845s	1	1	1	1	4.096s
RGB2WT1 TM3	RGB2WT1 TM2	RGB2WT1 TM1		RGB2WT1 TM0	Current ON time setting																																	
0	0	0		0	0.256s																																	
0	0	0		1	0.512s																																	
.	.	.		.	0.256s Step																																	
1	1	0		1	3.584s																																	
1	1	1		0	3.845s																																	
1	1	1		1	4.096s																																	
D6	RGB2WT1TM2	0																																				
D5	RGB2WT1TM1	0																																				
D4	RGB2WT1TM0	0																																				
D3	RGB2WT2TM3	0	<table border="1"> <thead> <tr> <th>RGB2WT2 TM3</th> <th>RGB2WT2 TM2</th> <th>RGB2WT2 TM1</th> <th>RGB2WT2 TM0</th> <th>Current ON time setting</th> </tr> </thead> <tbody> <tr> <td>0</td> <td>0</td> <td>0</td> <td>0</td> <td>0.256s</td> </tr> <tr> <td>0</td> <td>0</td> <td>0</td> <td>1</td> <td>0.512s</td> </tr> <tr> <td>.</td> <td>.</td> <td>.</td> <td>.</td> <td>0.256s Step</td> </tr> <tr> <td>1</td> <td>1</td> <td>0</td> <td>1</td> <td>3.584s</td> </tr> <tr> <td>1</td> <td>1</td> <td>1</td> <td>0</td> <td>3.845s</td> </tr> <tr> <td>1</td> <td>1</td> <td>1</td> <td>1</td> <td>4.096s</td> </tr> </tbody> </table> <p>Lighting time depends on internal OSC frequency.</p>	RGB2WT2 TM3	RGB2WT2 TM2	RGB2WT2 TM1	RGB2WT2 TM0	Current ON time setting	0	0	0	0	0.256s	0	0	0	1	0.512s	0.256s Step	1	1	0	1	3.584s	1	1	1	0	3.845s	1	1	1	1	4.096s
RGB2WT2 TM3	RGB2WT2 TM2	RGB2WT2 TM1		RGB2WT2 TM0	Current ON time setting																																	
0	0	0		0	0.256s																																	
0	0	0		1	0.512s																																	
.	.	.		.	0.256s Step																																	
1	1	0		1	3.584s																																	
1	1	1		0	3.845s																																	
1	1	1	1	4.096s																																		
D2	RGB2WT2TM2	0																																				
D1	RGB2WT2TM1	0																																				
D0	RGB2WT2TM0	0																																				

Address 12h <RGB2 slope 1step time setting>

BIT	Name	Initial	Function																																								
			RGB2SL1STEP3	RGB2SL1STEP2	RGB2SL1STEP1	RGB2SL1STEP0	Current ON time setting																																				
D7	RGB2SL1STEP3	0	<table border="1"> <tr><td>0</td><td>0</td><td>0</td><td>0</td><td>4ms</td></tr> <tr><td>0</td><td>0</td><td>0</td><td>1</td><td>8ms</td></tr> <tr><td>.</td><td>.</td><td>.</td><td>.</td><td>4ms</td></tr> <tr><td>.</td><td>.</td><td>.</td><td>.</td><td>Step</td></tr> <tr><td>.</td><td>.</td><td>.</td><td>.</td><td></td></tr> <tr><td>1</td><td>1</td><td>0</td><td>1</td><td>56ms</td></tr> <tr><td>1</td><td>1</td><td>1</td><td>0</td><td>60ms</td></tr> <tr><td>1</td><td>1</td><td>1</td><td>1</td><td>64ms</td></tr> </table> <p>Lighting time depends on internal OSC frequency.</p>	0	0	0	0	4ms	0	0	0	1	8ms	4ms	Step		1	1	0	1	56ms	1	1	1	0	60ms	1	1	1	1	64ms
0	0	0		0	4ms																																						
0	0	0		1	8ms																																						
.	.	.		.	4ms																																						
.	.	.		.	Step																																						
.	.	.		.																																							
1	1	0		1	56ms																																						
1	1	1		0	60ms																																						
1	1	1		1	64ms																																						
D6	RGB2SL1STEP2	0																																									
D5	RGB2SL1STEP1	0																																									
D4	RGB2SL1STEP0	0																																									
D3	RGB2SL2STEP3	0	<table border="1"> <tr><td>0</td><td>0</td><td>0</td><td>0</td><td>4ms</td></tr> <tr><td>0</td><td>0</td><td>0</td><td>1</td><td>8ms</td></tr> <tr><td>.</td><td>.</td><td>.</td><td>.</td><td>4ms</td></tr> <tr><td>.</td><td>.</td><td>.</td><td>.</td><td>Step</td></tr> <tr><td>.</td><td>.</td><td>.</td><td>.</td><td></td></tr> <tr><td>1</td><td>1</td><td>0</td><td>1</td><td>56ms</td></tr> <tr><td>1</td><td>1</td><td>1</td><td>0</td><td>60ms</td></tr> <tr><td>1</td><td>1</td><td>1</td><td>1</td><td>64ms</td></tr> </table> <p>Lighting time depends on internal OSC frequency.</p>	0	0	0	0	4ms	0	0	0	1	8ms	4ms	Step		1	1	0	1	56ms	1	1	1	0	60ms	1	1	1	1	64ms
0	0	0		0	4ms																																						
0	0	0		1	8ms																																						
.	.	.		.	4ms																																						
.	.	.		.	Step																																						
.	.	.		.																																							
1	1	0		1	56ms																																						
1	1	1	0	60ms																																							
1	1	1	1	64ms																																							
D2	RGB2SL2STEP2	0																																									
D1	RGB2SL2STEP1	0																																									
D0	RGB2SL2STEP0	0																																									

Address 13h <RGB2 slope step number setting>

BIT	Name	Initial	Function																																
			0	1																															
D7	-	-	-	-																															
D6	-	-	-	-																															
D5	-	-	-	-																															
D4	-	-	-	-																															
D3	-	-																																	
D2	RGB2SLNUM2	0	<table border="1"> <tr><td>0</td><td>0</td><td>0</td><td>1 Step</td></tr> <tr><td>0</td><td>0</td><td>1</td><td>2 Step</td></tr> <tr><td>0</td><td>1</td><td>0</td><td>4 Step</td></tr> <tr><td>0</td><td>1</td><td>1</td><td>8 Step</td></tr> <tr><td>1</td><td>0</td><td>0</td><td>16 Step</td></tr> <tr><td>1</td><td>0</td><td>1</td><td>32 Step</td></tr> <tr><td>1</td><td>1</td><td>0</td><td>64 Step</td></tr> <tr><td>1</td><td>1</td><td>1</td><td>(Prohibited)</td></tr> </table>	0	0	0	1 Step	0	0	1	2 Step	0	1	0	4 Step	0	1	1	8 Step	1	0	0	16 Step	1	0	1	32 Step	1	1	0	64 Step	1	1	1	(Prohibited)
0	0	0		1 Step																															
0	0	1		2 Step																															
0	1	0		4 Step																															
0	1	1		8 Step																															
1	0	0		16 Step																															
1	0	1		32 Step																															
1	1	0		64 Step																															
1	1	1		(Prohibited)																															
D1	RGB2SLNUM1	0																																	
D0	RGB2SLNUM0	0																																	

Address 14h <R2 LED current value1>

BIT	Name	Initial	Function																																																																													
			0	1																																																																												
D7	-	-	-	-																																																																												
D6	-	-	-	-																																																																												
D5	I1R2LED5	0	<table border="1"> <thead> <tr> <th>I1R2LED5</th> <th>I1R2LED4</th> <th>I1R2LED3</th> <th>I1R2LED2</th> <th>I1R2LED1</th> <th>I1R2LED0</th> <th>Current value</th> </tr> </thead> <tbody> <tr> <td>0</td> <td>0</td> <td>0</td> <td>0</td> <td>0</td> <td>0</td> <td>0mA</td> </tr> <tr> <td>0</td> <td>0</td> <td>0</td> <td>0</td> <td>0</td> <td>1</td> <td>0.5mA</td> </tr> <tr> <td>0</td> <td>0</td> <td>0</td> <td>0</td> <td>1</td> <td>0</td> <td>1mA</td> </tr> <tr> <td>.</td> <td>.</td> <td>.</td> <td>.</td> <td>.</td> <td>.</td> <td rowspan="4">0.5mA Step</td> </tr> <tr> <td>.</td> <td>.</td> <td>.</td> <td>.</td> <td>.</td> <td>.</td> </tr> <tr> <td>.</td> <td>.</td> <td>.</td> <td>.</td> <td>.</td> <td>.</td> </tr> <tr> <td>.</td> <td>.</td> <td>.</td> <td>.</td> <td>.</td> <td>.</td> </tr> <tr> <td></td> <td></td> <td></td> <td>1</td> <td>1</td> <td>0</td> <td>30.5mA</td> </tr> <tr> <td></td> <td></td> <td></td> <td>1</td> <td>1</td> <td>1</td> <td>31mA</td> </tr> <tr> <td></td> <td></td> <td></td> <td>1</td> <td>1</td> <td>1</td> <td>31.5mA</td> </tr> </tbody> </table> <p>When 120kΩ is connected to ISET pin.</p>				I1R2LED5	I1R2LED4	I1R2LED3	I1R2LED2	I1R2LED1	I1R2LED0	Current value	0	0	0	0	0	0	0mA	0	0	0	0	0	1	0.5mA	0	0	0	0	1	0	1mA	0.5mA Step				1	1	0	30.5mA				1	1	1	31mA				1	1	1	31.5mA
I1R2LED5	I1R2LED4	I1R2LED3					I1R2LED2	I1R2LED1	I1R2LED0	Current value																																																																						
0	0	0					0	0	0	0mA																																																																						
0	0	0					0	0	1	0.5mA																																																																						
0	0	0					0	1	0	1mA																																																																						
.	0.5mA Step																																																																						
.																																																																							
.																																																																							
.																																																																							
							1	1	0	30.5mA																																																																						
			1	1	1	31mA																																																																										
			1	1	1	31.5mA																																																																										
D4	I1R2LED4	0																																																																														
D3	I1R2LED3	0																																																																														
D2	I1R2LED2	0																																																																														
D1	I1R2LED1	0																																																																														
D0	I1R2LED0	0																																																																														

Address 15h <Δ current value for R2 LED current step >

BIT	Name	Initial	Function																																																																													
			0	1																																																																												
D7	-	-	-	-																																																																												
D6	-	-	-	-																																																																												
D5	IDLTR2LED5	0	<table border="1"> <thead> <tr> <th>IDLTR2 LED5</th> <th>IDLTR2 LED4</th> <th>IDLTR2 LED3</th> <th>IDLTR2 LED2</th> <th>IDLTR2 LED1</th> <th>IDLTR2 LED0</th> <th>Current value</th> </tr> </thead> <tbody> <tr> <td>0</td> <td>0</td> <td>0</td> <td>0</td> <td>0</td> <td>0</td> <td>0mA</td> </tr> <tr> <td>0</td> <td>0</td> <td>0</td> <td>0</td> <td>0</td> <td>1</td> <td>0.5mA</td> </tr> <tr> <td>0</td> <td>0</td> <td>0</td> <td>0</td> <td>1</td> <td>0</td> <td>1mA</td> </tr> <tr> <td>.</td> <td>.</td> <td>.</td> <td>.</td> <td>.</td> <td>.</td> <td rowspan="4">0.5mA Step</td> </tr> <tr> <td>.</td> <td>.</td> <td>.</td> <td>.</td> <td>.</td> <td>.</td> </tr> <tr> <td>.</td> <td>.</td> <td>.</td> <td>.</td> <td>.</td> <td>.</td> </tr> <tr> <td>.</td> <td>.</td> <td>.</td> <td>.</td> <td>.</td> <td>.</td> </tr> <tr> <td></td> <td></td> <td></td> <td>1</td> <td>1</td> <td>0</td> <td>30.5mA</td> </tr> <tr> <td></td> <td></td> <td></td> <td>1</td> <td>1</td> <td>1</td> <td>31mA</td> </tr> <tr> <td></td> <td></td> <td></td> <td>1</td> <td>1</td> <td>1</td> <td>31.5mA</td> </tr> </tbody> </table> <p>When 120kΩ is connected to ISET pin.</p>				IDLTR2 LED5	IDLTR2 LED4	IDLTR2 LED3	IDLTR2 LED2	IDLTR2 LED1	IDLTR2 LED0	Current value	0	0	0	0	0	0	0mA	0	0	0	0	0	1	0.5mA	0	0	0	0	1	0	1mA	0.5mA Step				1	1	0	30.5mA				1	1	1	31mA				1	1	1	31.5mA
IDLTR2 LED5	IDLTR2 LED4	IDLTR2 LED3					IDLTR2 LED2	IDLTR2 LED1	IDLTR2 LED0	Current value																																																																						
0	0	0					0	0	0	0mA																																																																						
0	0	0					0	0	1	0.5mA																																																																						
0	0	0					0	1	0	1mA																																																																						
.	0.5mA Step																																																																						
.																																																																							
.																																																																							
.																																																																							
							1	1	0	30.5mA																																																																						
			1	1	1	31mA																																																																										
			1	1	1	31.5mA																																																																										
D4	IDLTR2LED4	0																																																																														
D3	IDLTR2LED3	0																																																																														
D2	IDLTR2LED2	0																																																																														
D1	IDLTR2LED1	0																																																																														
D0	IDLTR2LED0	0																																																																														

Address 16h <G2 LED current value1>

BIT	Name	Initial	Function																																																																							
			0	1																																																																						
D7	-	-	-	-																																																																						
D6	-	-	-	-																																																																						
D5	I1G2LED5	0	<table border="1"> <thead> <tr> <th>I1G2LED 5</th> <th>I1G2LED 4</th> <th>I1G2LED 3</th> <th>I1G2LED 2</th> <th>I1G2LED 1</th> <th>I1G2LED 0</th> <th>Current value</th> </tr> </thead> <tbody> <tr> <td>0</td> <td>0</td> <td>0</td> <td>0</td> <td>0</td> <td>0</td> <td>0mA</td> </tr> <tr> <td>0</td> <td>0</td> <td>0</td> <td>0</td> <td>0</td> <td>1</td> <td>0.5mA</td> </tr> <tr> <td>0</td> <td>0</td> <td>0</td> <td>0</td> <td>1</td> <td>0</td> <td>1mA</td> </tr> <tr> <td>.</td> <td>.</td> <td>.</td> <td>.</td> <td>.</td> <td>.</td> <td rowspan="3">0.5mA Step</td> </tr> <tr> <td>.</td> <td>.</td> <td>.</td> <td>.</td> <td>.</td> <td>.</td> </tr> <tr> <td>.</td> <td>.</td> <td>.</td> <td>.</td> <td>.</td> <td>.</td> </tr> <tr> <td>1</td> <td>1</td> <td>1</td> <td>1</td> <td>0</td> <td>1</td> <td>30.5mA</td> </tr> <tr> <td>1</td> <td>1</td> <td>1</td> <td>1</td> <td>1</td> <td>0</td> <td>31mA</td> </tr> <tr> <td>1</td> <td>1</td> <td>1</td> <td>1</td> <td>1</td> <td>1</td> <td>31.5mA</td> </tr> </tbody> </table> <p>When 120kΩ is connected to ISET pin.</p>				I1G2LED 5	I1G2LED 4	I1G2LED 3	I1G2LED 2	I1G2LED 1	I1G2LED 0	Current value	0	0	0	0	0	0	0mA	0	0	0	0	0	1	0.5mA	0	0	0	0	1	0	1mA	0.5mA Step	1	1	1	1	0	1	30.5mA	1	1	1	1	1	0	31mA	1	1	1	1	1	1	31.5mA
I1G2LED 5	I1G2LED 4	I1G2LED 3					I1G2LED 2	I1G2LED 1	I1G2LED 0	Current value																																																																
0	0	0					0	0	0	0mA																																																																
0	0	0					0	0	1	0.5mA																																																																
0	0	0					0	1	0	1mA																																																																
.	0.5mA Step																																																																
.																																																																	
.																																																																	
1	1	1					1	0	1	30.5mA																																																																
1	1	1					1	1	0	31mA																																																																
1	1	1	1	1	1	31.5mA																																																																				
D4	I1G2LED4	0																																																																								
D3	I1G2LED3	0																																																																								
D2	I1G2LED2	0																																																																								
D1	I1G2LED1	0																																																																								
D0	I1G2LED0	0																																																																								

Address 17h <Δ current value for G2 LED current step >

BIT	Name	Initial	Function																																																																							
			0	1																																																																						
D7	-	-	-	-																																																																						
D6	-	-	-	-																																																																						
D5	IDLTG2LED5	0	<table border="1"> <thead> <tr> <th>IDLTG2 LED5</th> <th>IDLTG2 LED4</th> <th>IDLTG2 LED3</th> <th>IDLTG2 LED2</th> <th>IDLTG2 LED1</th> <th>IDLTG2 LED0</th> <th>Current value</th> </tr> </thead> <tbody> <tr> <td>0</td> <td>0</td> <td>0</td> <td>0</td> <td>0</td> <td>0</td> <td>0mA</td> </tr> <tr> <td>0</td> <td>0</td> <td>0</td> <td>0</td> <td>0</td> <td>1</td> <td>0.5mA</td> </tr> <tr> <td>0</td> <td>0</td> <td>0</td> <td>0</td> <td>1</td> <td>0</td> <td>1mA</td> </tr> <tr> <td>.</td> <td>.</td> <td>.</td> <td>.</td> <td>.</td> <td>.</td> <td rowspan="3">0.5mA Step</td> </tr> <tr> <td>.</td> <td>.</td> <td>.</td> <td>.</td> <td>.</td> <td>.</td> </tr> <tr> <td>.</td> <td>.</td> <td>.</td> <td>.</td> <td>.</td> <td>.</td> </tr> <tr> <td>1</td> <td>1</td> <td>1</td> <td>1</td> <td>0</td> <td>1</td> <td>30.5mA</td> </tr> <tr> <td>1</td> <td>1</td> <td>1</td> <td>1</td> <td>1</td> <td>0</td> <td>31mA</td> </tr> <tr> <td>1</td> <td>1</td> <td>1</td> <td>1</td> <td>1</td> <td>1</td> <td>31.5mA</td> </tr> </tbody> </table> <p>When 120kΩ is connected to ISET pin.</p>				IDLTG2 LED5	IDLTG2 LED4	IDLTG2 LED3	IDLTG2 LED2	IDLTG2 LED1	IDLTG2 LED0	Current value	0	0	0	0	0	0	0mA	0	0	0	0	0	1	0.5mA	0	0	0	0	1	0	1mA	0.5mA Step	1	1	1	1	0	1	30.5mA	1	1	1	1	1	0	31mA	1	1	1	1	1	1	31.5mA
IDLTG2 LED5	IDLTG2 LED4	IDLTG2 LED3					IDLTG2 LED2	IDLTG2 LED1	IDLTG2 LED0	Current value																																																																
0	0	0					0	0	0	0mA																																																																
0	0	0					0	0	1	0.5mA																																																																
0	0	0					0	1	0	1mA																																																																
.	0.5mA Step																																																																
.																																																																	
.																																																																	
1	1	1					1	0	1	30.5mA																																																																
1	1	1					1	1	0	31mA																																																																
1	1	1	1	1	1	31.5mA																																																																				
D4	IDLTG2LED4	0																																																																								
D3	IDLTG2LED3	0																																																																								
D2	IDLTG2LED2	0																																																																								
D1	IDLTG2LED1	0																																																																								
D0	IDLTG2LED0	0																																																																								

Address 18h <B2 LED current value1>

BIT	Name	Initial	Function																																																																							
			0	1																																																																						
D7	-	-	-	-																																																																						
D6	-	-	-	-																																																																						
D5	I1B2LED5	0	<table border="1"> <thead> <tr> <th>I1B2LED5</th> <th>I1B2LED4</th> <th>I1B2LED3</th> <th>I1B2LED2</th> <th>I1B2LED1</th> <th>I1B2LED0</th> <th>Current value</th> </tr> </thead> <tbody> <tr> <td>0</td> <td>0</td> <td>0</td> <td>0</td> <td>0</td> <td>0</td> <td>0mA</td> </tr> <tr> <td>0</td> <td>0</td> <td>0</td> <td>0</td> <td>0</td> <td>1</td> <td>0.5mA</td> </tr> <tr> <td>0</td> <td>0</td> <td>0</td> <td>0</td> <td>1</td> <td>0</td> <td>1mA</td> </tr> <tr> <td>.</td> <td>.</td> <td>.</td> <td>.</td> <td>.</td> <td>.</td> <td rowspan="3">0.5mA Step</td> </tr> <tr> <td>.</td> <td>.</td> <td>.</td> <td>.</td> <td>.</td> <td>.</td> </tr> <tr> <td>.</td> <td>.</td> <td>.</td> <td>.</td> <td>.</td> <td>.</td> </tr> <tr> <td>1</td> <td>1</td> <td>1</td> <td>1</td> <td>0</td> <td>1</td> <td>30.5mA</td> </tr> <tr> <td>1</td> <td>1</td> <td>1</td> <td>1</td> <td>1</td> <td>0</td> <td>31mA</td> </tr> <tr> <td>1</td> <td>1</td> <td>1</td> <td>1</td> <td>1</td> <td>1</td> <td>31.5mA</td> </tr> </tbody> </table> <p>When 120kΩ is connected to ISET pin.</p>				I1B2LED5	I1B2LED4	I1B2LED3	I1B2LED2	I1B2LED1	I1B2LED0	Current value	0	0	0	0	0	0	0mA	0	0	0	0	0	1	0.5mA	0	0	0	0	1	0	1mA	0.5mA Step	1	1	1	1	0	1	30.5mA	1	1	1	1	1	0	31mA	1	1	1	1	1	1	31.5mA
I1B2LED5	I1B2LED4	I1B2LED3					I1B2LED2	I1B2LED1	I1B2LED0	Current value																																																																
0	0	0					0	0	0	0mA																																																																
0	0	0					0	0	1	0.5mA																																																																
0	0	0					0	1	0	1mA																																																																
.	0.5mA Step																																																																
.																																																																	
.																																																																	
1	1	1					1	0	1	30.5mA																																																																
1	1	1					1	1	0	31mA																																																																
1	1	1	1	1	1	31.5mA																																																																				
D4	I1B2LED4	0																																																																								
D3	I1B2LED3	0																																																																								
D2	I1B2LED2	0																																																																								
D1	I1B2LED1	0																																																																								
D0	I1B2LED0	0																																																																								

Address 19h <Δ current value for B2 LED current step >

BIT	Name	Initial	Function																																																																							
			0	1																																																																						
D7	-	-	-	-																																																																						
D6	-	-	-	-																																																																						
D5	IDLTB2LED5	0	<table border="1"> <thead> <tr> <th>IDLTB2 LED5</th> <th>IDLTB2 LED4</th> <th>IDLTB2 LED3</th> <th>IDLTB2 LED2</th> <th>IDLTB2 LED1</th> <th>IDLTB2 LED0</th> <th>Current value</th> </tr> </thead> <tbody> <tr> <td>0</td> <td>0</td> <td>0</td> <td>0</td> <td>0</td> <td>0</td> <td>0mA</td> </tr> <tr> <td>0</td> <td>0</td> <td>0</td> <td>0</td> <td>0</td> <td>1</td> <td>0.5mA</td> </tr> <tr> <td>0</td> <td>0</td> <td>0</td> <td>0</td> <td>1</td> <td>0</td> <td>1mA</td> </tr> <tr> <td>.</td> <td>.</td> <td>.</td> <td>.</td> <td>.</td> <td>.</td> <td rowspan="3">0.5mA Step</td> </tr> <tr> <td>.</td> <td>.</td> <td>.</td> <td>.</td> <td>.</td> <td>.</td> </tr> <tr> <td>.</td> <td>.</td> <td>.</td> <td>.</td> <td>.</td> <td>.</td> </tr> <tr> <td>1</td> <td>1</td> <td>1</td> <td>1</td> <td>0</td> <td>1</td> <td>30.5mA</td> </tr> <tr> <td>1</td> <td>1</td> <td>1</td> <td>1</td> <td>1</td> <td>0</td> <td>31mA</td> </tr> <tr> <td>1</td> <td>1</td> <td>1</td> <td>1</td> <td>1</td> <td>1</td> <td>31.5mA</td> </tr> </tbody> </table> <p>When 120kΩ is connected to ISET pin.</p>				IDLTB2 LED5	IDLTB2 LED4	IDLTB2 LED3	IDLTB2 LED2	IDLTB2 LED1	IDLTB2 LED0	Current value	0	0	0	0	0	0	0mA	0	0	0	0	0	1	0.5mA	0	0	0	0	1	0	1mA	0.5mA Step	1	1	1	1	0	1	30.5mA	1	1	1	1	1	0	31mA	1	1	1	1	1	1	31.5mA
IDLTB2 LED5	IDLTB2 LED4	IDLTB2 LED3					IDLTB2 LED2	IDLTB2 LED1	IDLTB2 LED0	Current value																																																																
0	0	0					0	0	0	0mA																																																																
0	0	0					0	0	1	0.5mA																																																																
0	0	0					0	1	0	1mA																																																																
.	0.5mA Step																																																																
.																																																																	
.																																																																	
1	1	1					1	0	1	30.5mA																																																																
1	1	1					1	1	0	31mA																																																																
1	1	1	1	1	1	31.5mA																																																																				
D4	IDLTB2LED4	0																																																																								
D3	IDLTB2LED3	0																																																																								
D2	IDLTB2LED2	0																																																																								
D1	IDLTB2LED1	0																																																																								
D0	IDLTB2LED0	0																																																																								

Address 1Ah <RGB1, RGB2 LED external ON/OFF control>

BIT	Name	Initial	Function																
			0	1															
D7	-	-	-	-															
D6	-	-	-	-															
D5	-	-	-	-															
D4	-	-	-	-															
D3	-	-	-	-															
D2	-	-	-	-															
D1	RGB2MEL	0	<table border="1"> <thead> <tr> <th>RGB*MEL</th> <th>RGB*CNT (external pin)</th> <th>RGB* LED Lighting</th> </tr> </thead> <tbody> <tr> <td>0</td> <td>L</td> <td>ON</td> </tr> <tr> <td>0</td> <td>H</td> <td>ON</td> </tr> <tr> <td>1</td> <td>L</td> <td>OFF</td> </tr> <tr> <td>1</td> <td>H</td> <td>ON</td> </tr> </tbody> </table> <p>But, a state of lighting depends on the setup of other registers.</p>		RGB*MEL	RGB*CNT (external pin)	RGB* LED Lighting	0	L	ON	0	H	ON	1	L	OFF	1	H	ON
RGB*MEL	RGB*CNT (external pin)	RGB* LED Lighting																	
0	L	ON																	
0	H	ON																	
1	L	OFF																	
1	H	ON																	
D0	RGB1MEL	0																	

●RGB LED operating

1. Operating mode

RGB LED can set up the following operating mode by the setup of the register.

<Setup register>

I1**LED : (register) Initial electric current value [mA]

IDLT**LED : (register) The electric current Δ value of around 1Step [mA]

RGB*SLNUM : (register) slope step number (1,2,4,8,16,32,64 Step)

RGB*SL1STEP : (register) The first half slope 1Step time [ms]

RGB*SL2STEP : (register) The latter half slope 1Step time [ms]

RGB*WT1TM : (register) The first half lighting time [ms]

RGB*WT2TM : (register) The latter half lighting time [ms]

As for the following setup, calculate it from the above setup.

$I2^{**LED} : \text{At the time of middle lighting current value [mA]} = I1^{**LED} + IDLT^{**LED} \times RGB*SLNUM$

(In case of the value that a calculation exceeds maximum value, the current value is at the limit with maximum.)

$RGB*SL1TM : \text{The first half slope time [ms]} = RGB*SL1STEP \times RGB*SLNUM$

$RGB*SL2TM : \text{The latter half slope time [ms]} = RGB*SL2STEP \times RGB*SLNUM$

Each setup is necessary for DC current (at Normal mode or Blink mode).

(* : 1/2 channels is shown. ** : R1/G1/B1/R2 /G2/B2 is shown.)

Note) The current value in the table, it is value when 120k Ω is connected to ISET pin.

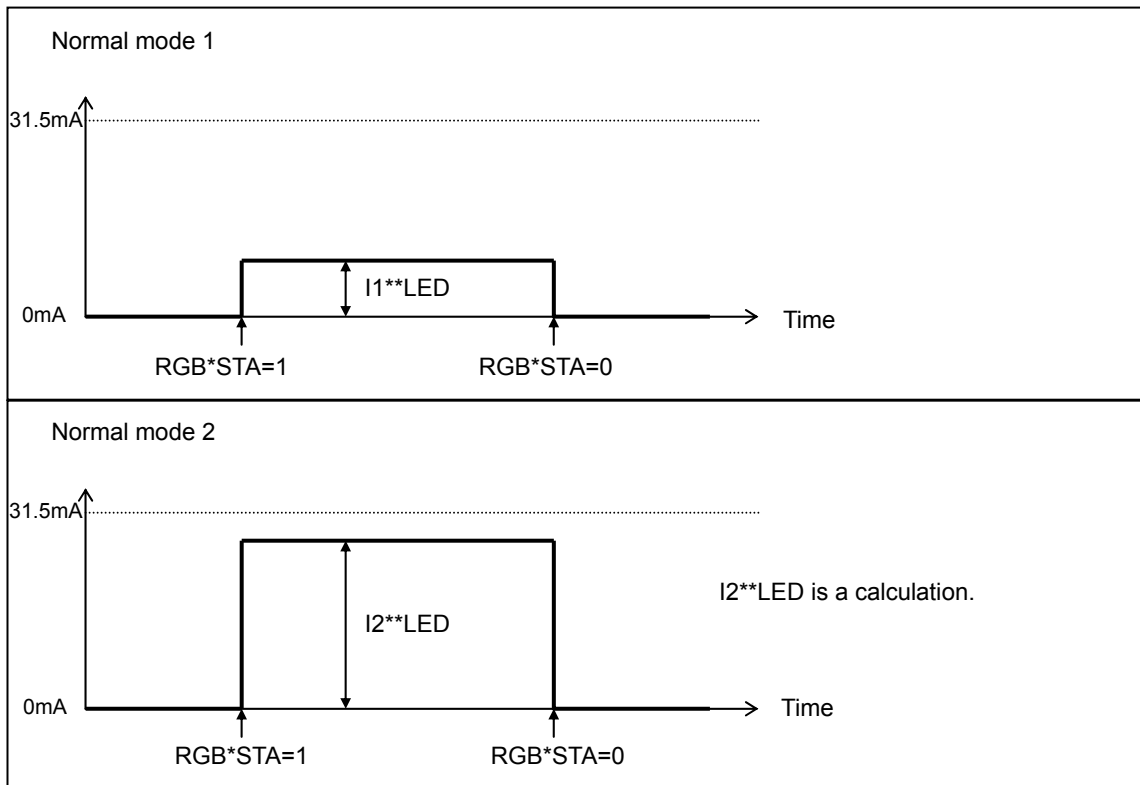

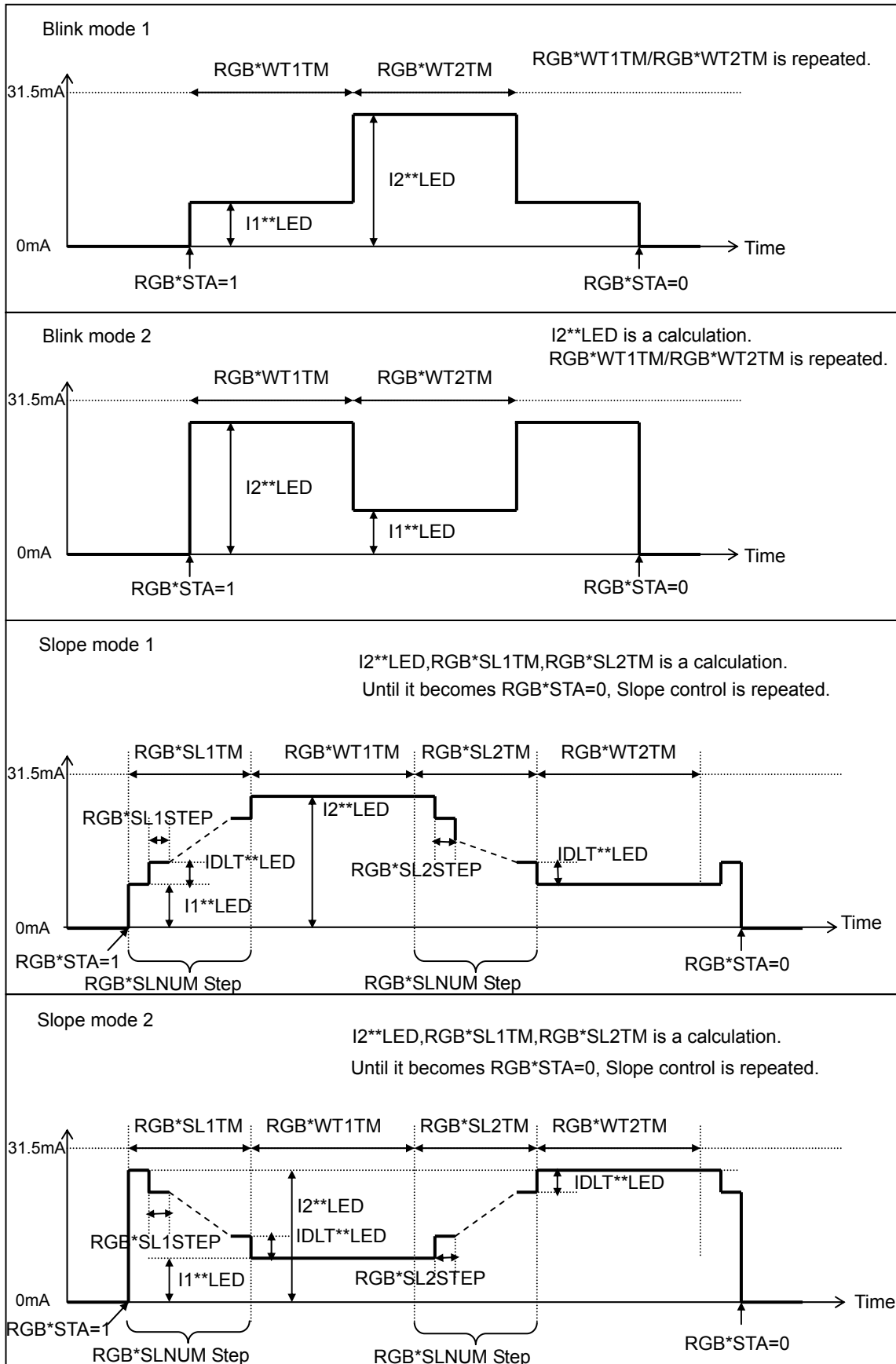

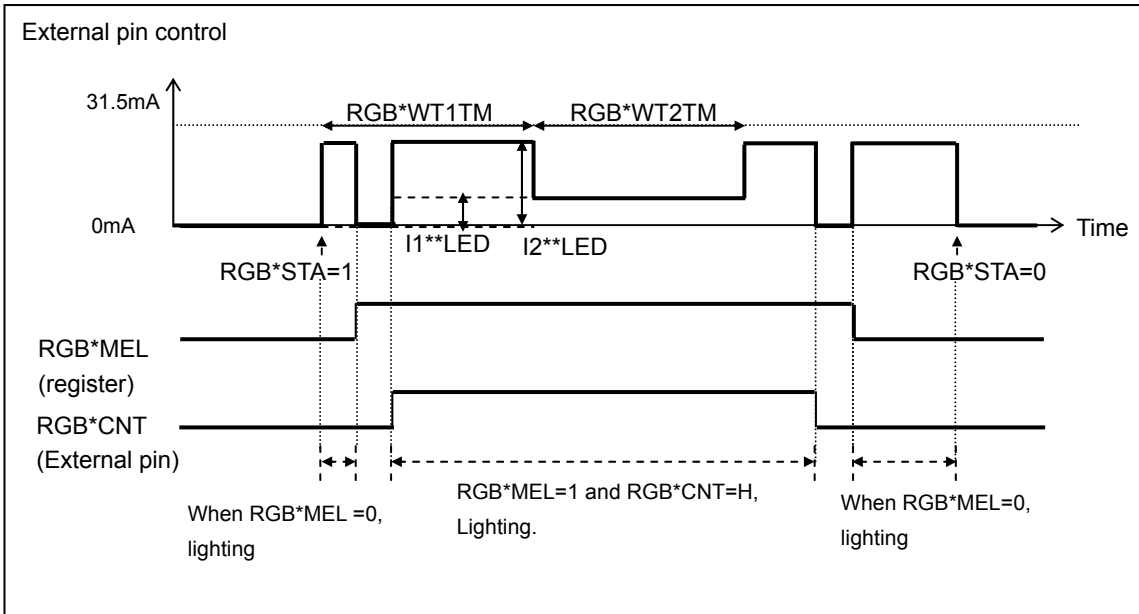

2. Slope control

The slope control that this LSI is equipped processes step time inside as follows. It is made to have electric current by the log curve that is a simple target as to the slope.

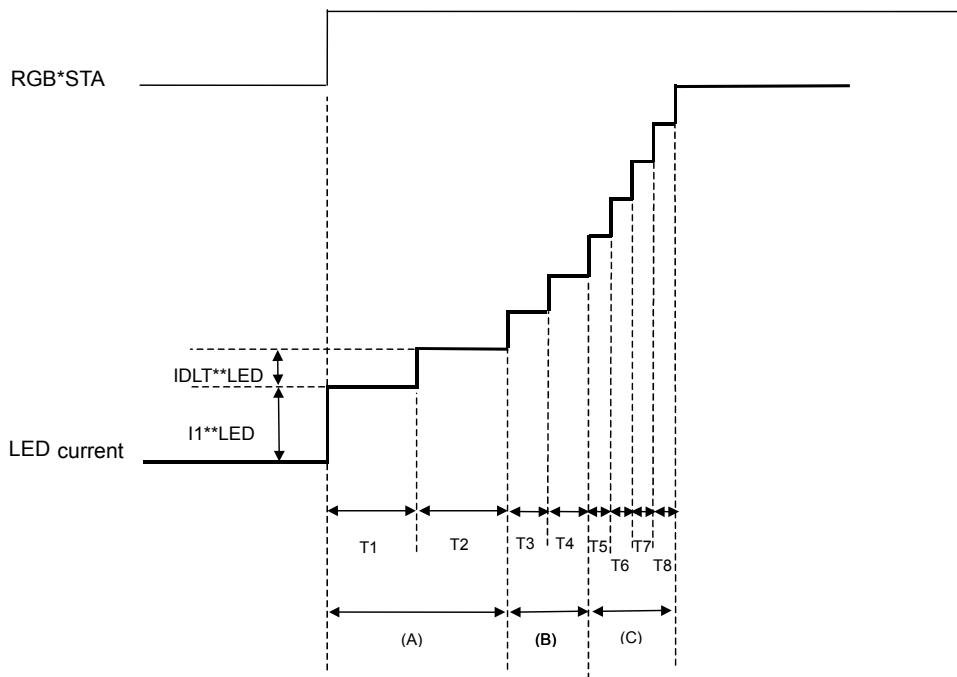

- (A)Section : It transits at the step time of two times when it was set up with RGB*SL1STEP
- (B)Section : It transits at the step time when it was set up with RGB*SL1STEP.
- (C)Section : It transits at the step time of a half times when it was set up with RGB*SL1STEP.

The time of the total (RGB*SL1TM) is calculated with RGB*SL1STEP x RGB*SLNUM.

A similar movement is done on the descent (RGB*SL2TM) side as well.

The acceptance of the setup of a register concerned with LED working during the slope movement stops.

But, a RGB*STA signal interrupts even during the slope movement, and it is possible that LED is turned off.

●Explanation for operate

1. Reset

There are two kinds of reset, software reset and hardware reset.

(1) Software reset

- All the registers are initialized more than making a register (SFTRST) setup "1".
- The register of software resetting is an automatic return (Auto Return 0).

(2) Hardware reset

- It shifts to hardware reset by changing RESET pin "H" → "L".
- The condition of all the registers under hardware reset pin is returned to the initial value, and it stops accepting all address.
- It's possible to release from a state of hardware reset by setting register "L" → "H".
- RESET pin has delay circuit. It doesn't recognize as hardware reset in "L" period under 5μs.

(3) Reset Sequence

- When hardware reset was done during software reset, software reset is canceled when hardware reset is canceled. (Because the initial value of software reset is "0")

2. Thermal shutdown

The blocks which thermal shutdown function is effective in the following.

Charge pump

LED Driver

REG1

REG2 is not shut down by thermal shutdown function, because REG2 can be used for I/O voltage.

A thermal shutdown function works in about 195 °C.

Detection temperature has a hysteresis, and detection release temperature is about 175 °C.

(Design reference value)

3. DC/DC

Start up

DC/DC circuit operates when either LED turns ON.
 (But, when LED connection is set to DC/DC output (VOUT) only.)
 DC/DC circuit has soft start function to prevent a rush current.
 VBAT and VIO sequence is as follow.

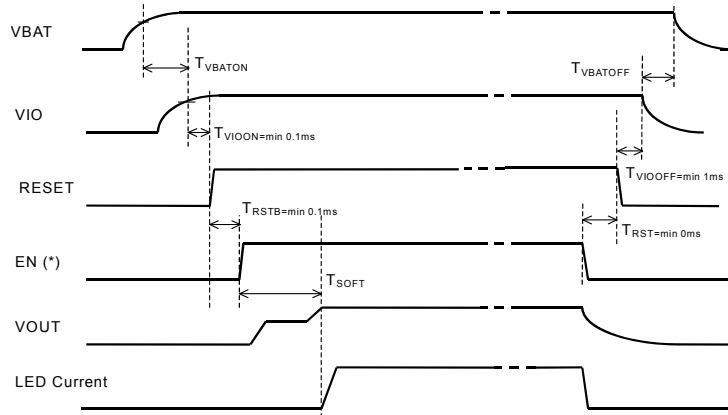

(*) An EN signal means the following in the upper figure.

EN = "MLEDEN" or "SLEDEN" or "RGB1STA" or "RGB2STA"

(= LED The LED lighting control of a setup of connection VOUT)

But, as for $V_{BAT} < 2.2V$ (typ) or $T_a > T_{TSD}$ (typ : 195° C), a protection function functions, and an EN signal doesn't become effective.

Mode transition

The transition of boosts multiple transits automatically by the VBAT voltage and the voltage of the LED electric current inflow pin.

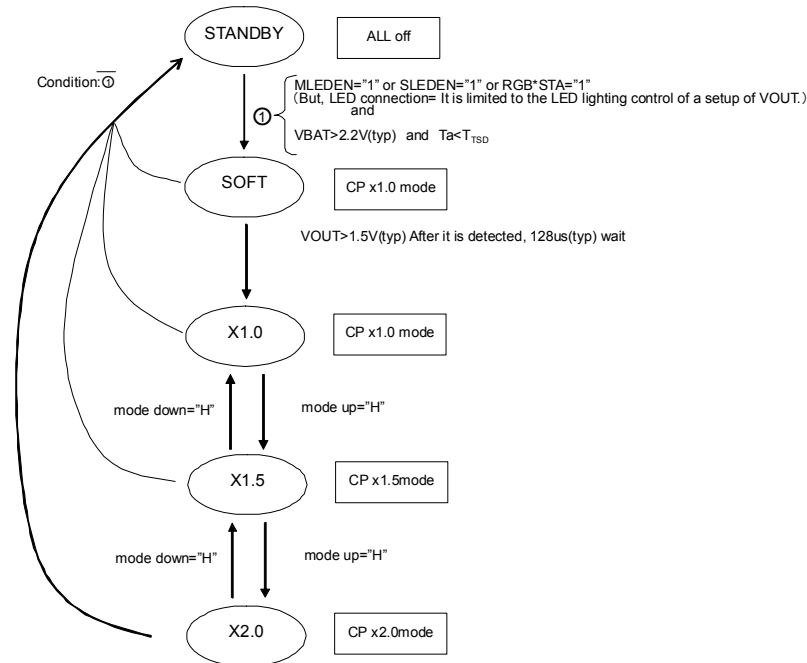

Over voltage protection / Over current protection

DC/DC circuit output (VOUT) is equipped with the over-voltage protection and the over current protection function.
 A VOUT over-voltage detection voltage is about 6.0V. (VOUT at the time of rise in a voltage)
 A detection voltage has a hysteresis, and a detection release voltage is about 5.75V. (Design reference value)
 And, when VOUT output short-circuits in GND, drain electric current is controlled by an over current protection function.

4. LED Driver

LED current value setting

LED maximum current value (White LED driver and RGB LED Driver common) can be established in the resistance value R_{ISET} that it is connected to the ISET Pin.

A setting is shown in the following.

$$I_{LEDmax} = 6.4 \times 0.6 [V] / R_{ISET} [k\Omega] [A] \text{ (Typ)} \quad \text{MLED1to4, SLED1to2}$$

$$I_{LEDmax} = 6.3 \times 0.6 [V] / R_{ISET} [k\Omega] [A] \text{ (Typ)} \quad \text{All RGB LED}$$

The maximum setting of LED current is 32mA (MLED and SLED), 31.5mA (RGB) on the D range of the internal circuit.

LED current overload protection

ISET Pin is mount with the GND short detection function. LED current value prevents excessive LED current from flowing when ISET Pin becomes low impedance because it is shown with a formula of the former extension.

White LED Driver

The number of lighting of white LED can be set up by the register MLEDSEL and SLEDSEL (address02h).

The settlement of the number of lighting can be setup with follow.

Main LCD Back light · · · 3 Light (MLED1 ~ 3) or 4 Light (MLED1 ~ 4)

Sub LCD Back light · · · 1 Light (SLED1) or 2 Light (SLED1 ~ 2)

Connect the LED pin that isn't used to the ground.

RGB LED Driver

By register B*LEDMD and G*LEDMD (address05h), a place of connection of Green LED and Blue LED It can be set up in VBAT or VOUT. When V_f is low, it is connected to VBAT, and it is possible that efficiency is raised.

When a VBAT connection is chosen, a feedback route to the DC/DC circuit is interrupted, and it works as a simple constant current driver.

A write protect is given in the following address when "1" is written in the RGB*STA register.

Register	A protected address
RGB1STA	06h ~ 0Fh
RGB2STA	10h ~ 19h

VBAT connection a start in the setup Sequence

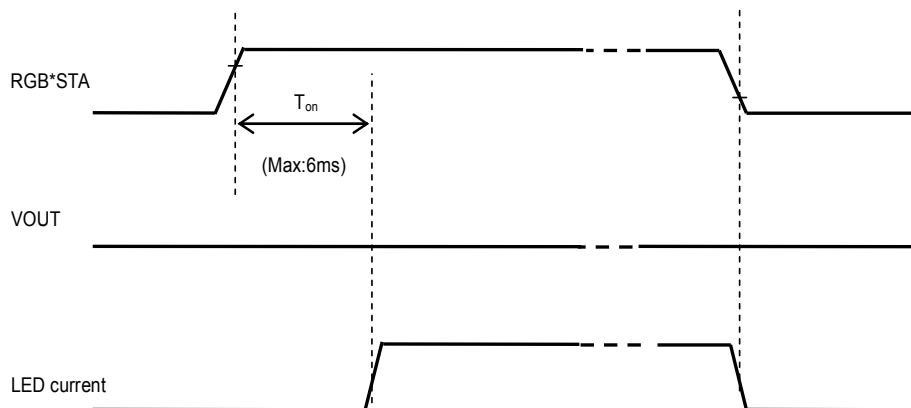

When the connection of LED is VBAT, only a LED driver turns it on, and a DC/DC circuit is turned off.

The LED pin which isn't used is to short to the ground.

But, the setup of a register concerned with LED that isn't used is prohibited.

5. I/O

CPU interface control input is possible low voltage interface. Interface peripheral block diagram is as follows.

VIO voltage or interface voltage is possible the setting range of 1.65~3.3V. (But, VBAT voltage \geq VIO voltage)

Also, I/O of with enable is being used for SCL, SDA input as a prevention of clock propagation to the inside when other LSI shared the SCL, SDA line.

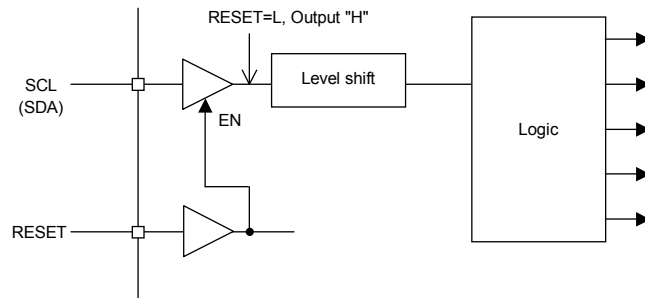

An equivalent circuit around the part I/O becomes p.8. By rising turn of the I/O power supply and the input level be careful enough because an electric current route may occur through the protection Diode of the pin.

6. About the start of REG2 (the voltage for I/O)

It must start as follows when REG2 output is used as VIO voltage.

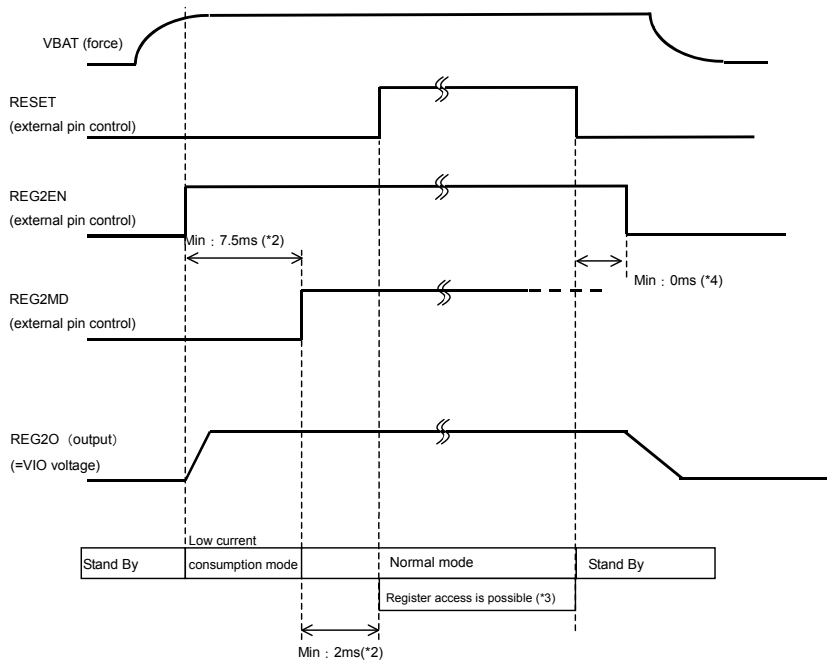

- (*1) This sequence is when REG2O is used as an I/O voltage.
Take the specifications of the outside power supply into consideration when the I/O voltage is applied from outside.
- (*2) When the low consumption mode is unnecessary, REG2EN=REG2MD (simultaneous control) is possible.
But, at that case as well, REG2 rising time in the normal mode Take a (Min : 2ms) into consideration.
- (*3) REG2 should go for a release of RESET at the time of the normal mode.
- (*4) REG2EN= Though "L" and RESET= "L" don't care even about the simultaneous timing,
It is prohibition to take REG2EN= "L" in front of RESET= "L".

It must start as follows when external power supply is used as VIO voltage.

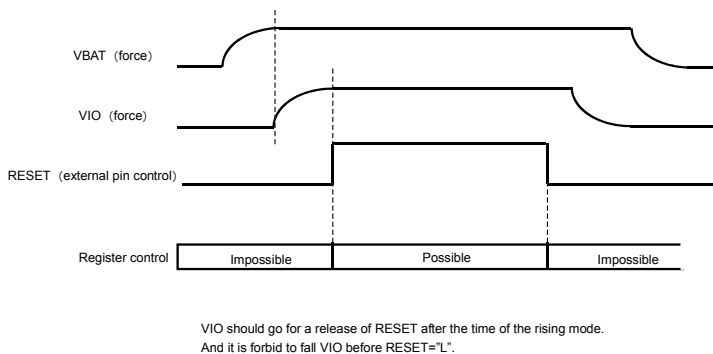

VIO should go for a release of RESET after the time of the rising mode.
And it is forbid to fall VIO before RESET="L".

7. About the pin management of the function that isn't used and test pins

Please connect the pin that isn't used and test pin referred to equivalent circuit (P.8).

- TESTI1, TESTI2 Short to GND (Must) because input pin for test
- TESTO1, TESTO2 Be OPEN because output for test
- T1~T4 Short to GND (Must) because input pin for test
- Non-used LED Pin Short to GND

But, the setup of a register concerned with LED that isn't used is prohibited.

- REG2EN, REG2MD, RGB1CNT, RGB2CNT Pull-Down resistance is built in.
Short to GND

10. BD6081GU PCB pattern of the Power dissipation measuring board

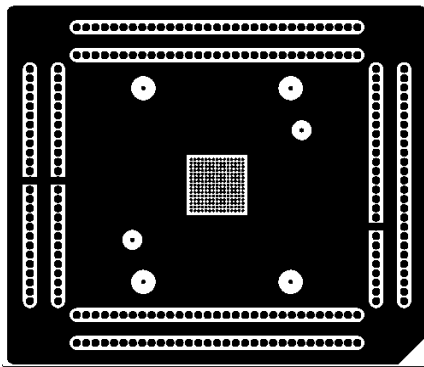

1st layer(component)

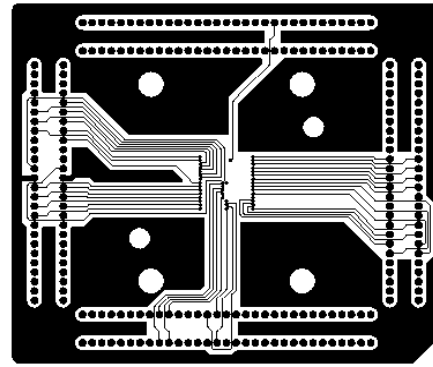

2nd layer

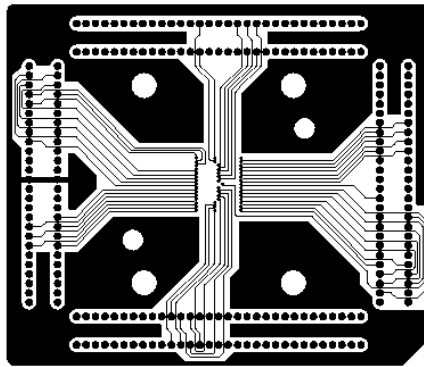

3rd layer

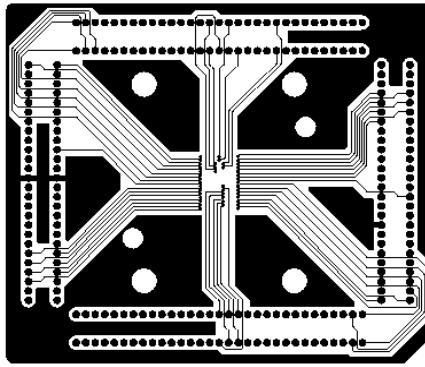

4th layer

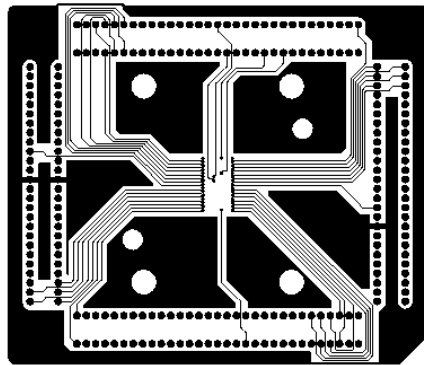

5th layer

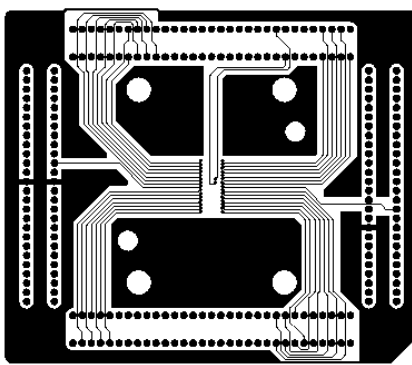

6th layer

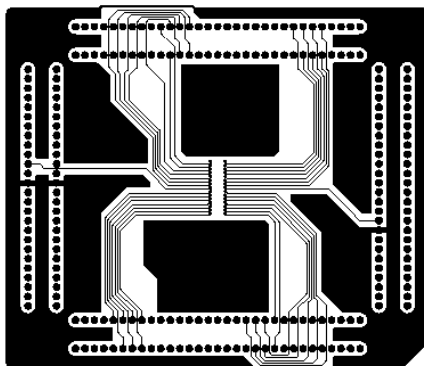

7th layer

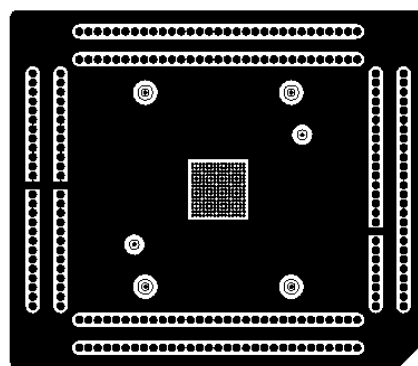

8th layer(solder)

●Notes for use**(1) Absolute Maximum Ratings**

An excess in the absolute maximum ratings, such as supply voltage, temperature range of operating conditions, etc., can break down devices, thus making impossible to identify breaking mode such as a short circuit or an open circuit. If any special mode exceeding the absolute maximum ratings is assumed, consideration should be given to take physical safety measures including the use of fuses, etc.

(2) Power supply and ground line

Design PCB pattern to provide low impedance for the wiring between the power supply and the ground lines. Pay attention to the interference by common impedance of layout pattern when there are plural power supplies and ground lines. Especially, when there are ground pattern for small signal and ground pattern for large current included the external circuits, please separate each ground pattern. Furthermore, for all power supply pins to ICs, mount a capacitor between the power supply and the ground pin. At the same time, in order to use a capacitor, thoroughly check to be sure the characteristics of the capacitor to be used present no problem including the occurrence of capacity dropout at a low temperature, thus determining the constant.

(3) Ground voltage

Make setting of the potential of the ground pin so that it will be maintained at the minimum in any operating state. Furthermore, check to be sure no pins are at a potential lower than the ground voltage including an actual electric transient.

(4) Short circuit between pins and erroneous mounting

In order to mount ICs on a set PCB, pay thorough attention to the direction and offset of the ICs. Erroneous mounting can break down the ICs. Furthermore, if a short circuit occurs due to foreign matters entering between pins or between the pin and the power supply or the ground pin, the ICs can break down.

(5) Operation in strong electromagnetic field

Be noted that using ICs in the strong electromagnetic field can malfunction them.

(6) Input pins

In terms of the construction of IC, parasitic elements are inevitably formed in relation to potential. The operation of the parasitic element can cause interference with circuit operation, thus resulting in a malfunction and then breakdown of the input pin. Therefore, pay thorough attention not to handle the input pins, such as to apply to the input pins a voltage lower than the ground respectively, so that any parasitic element will operate. Furthermore, do not apply a voltage to the input pins when no power supply voltage is applied to the IC. In addition, even if the power supply voltage is applied, apply to the input pins a voltage lower than the power supply voltage or within the guaranteed value of electrical characteristics.

(7) External capacitor

In order to use a ceramic capacitor as the external capacitor, determine the constant with consideration given to a degradation in the nominal capacitance due to DC bias and changes in the capacitance due to temperature, etc.

(8) Thermal shutdown circuit (TSD)

This LSI builds in a thermal shutdown (TSD) circuit. When junction temperatures become detection temperature or higher, the thermal shutdown circuit operates and turns a switch OFF. The thermal shutdown circuit, which is aimed at isolating the LSI from thermal runaway as much as possible, is not aimed at the protection or guarantee of the LSI. Therefore, do not continuously use the LSI with this circuit operating or use the LSI assuming its operation.

(9) Thermal design

Perform thermal design in which there are adequate margins by taking into account the permissible dissipation (Pd) in actual states of use.

(10) LDO

Use each output of LDO by the independence. Don't use under the condition that each output is short-circuited because it has the possibility that an operation becomes unstable.

(11) About the pin for the test, the un-use pin

Prevent a problem from being in the pin for the test and the un-use pin under the state of actual use. Please refer to a function manual and an application notebook. And, as for the pin that doesn't specially have an explanation, ask our company person in charge.

(12) About the function description or application note or more.

The function manual and the application notebook are the design materials to design a set. So, the contents of the materials aren't always guaranteed. Please design application by having fully examination and evaluation include the external elements.

● Ordering part number

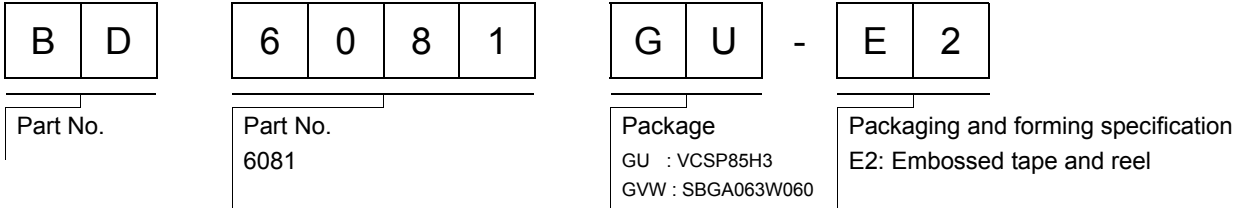

VCSP85H3 (BD6081GU)

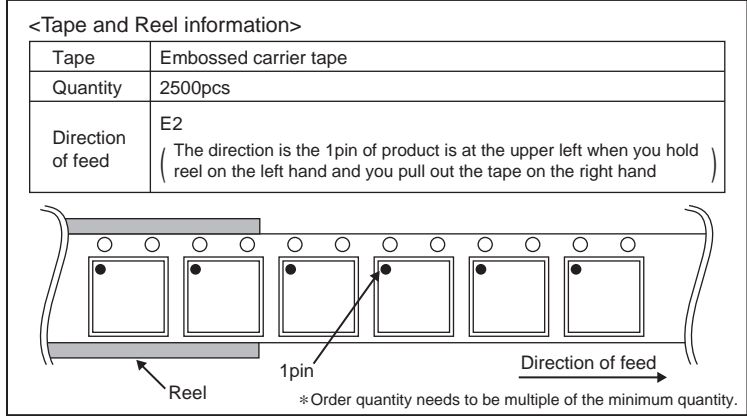
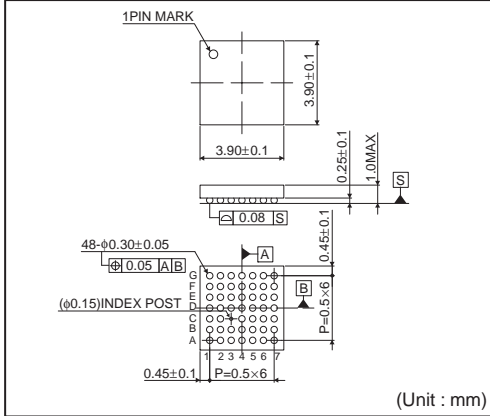

SBGA063W060

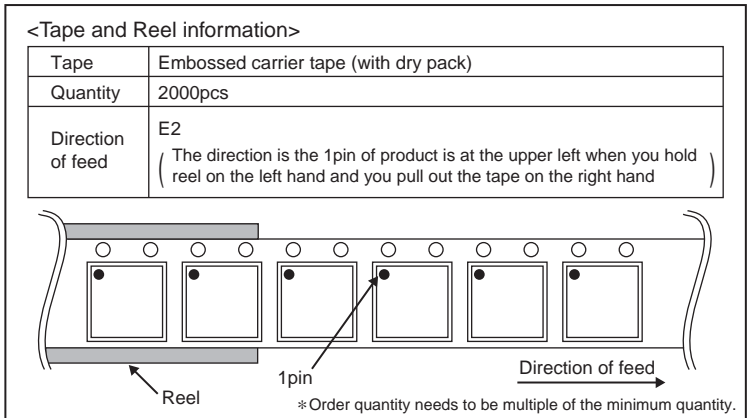
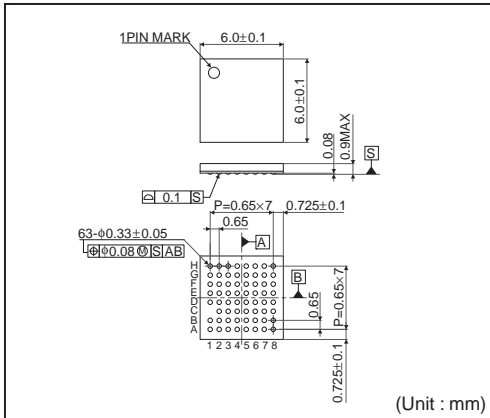

Notes

No copying or reproduction of this document, in part or in whole, is permitted without the consent of ROHM Co.,Ltd.

The content specified herein is subject to change for improvement without notice.

The content specified herein is for the purpose of introducing ROHM's products (hereinafter "Products"). If you wish to use any such Product, please be sure to refer to the specifications, which can be obtained from ROHM upon request.

Examples of application circuits, circuit constants and any other information contained herein illustrate the standard usage and operations of the Products. The peripheral conditions must be taken into account when designing circuits for mass production.

Great care was taken in ensuring the accuracy of the information specified in this document. However, should you incur any damage arising from any inaccuracy or misprint of such information, ROHM shall bear no responsibility for such damage.

The technical information specified herein is intended only to show the typical functions of and examples of application circuits for the Products. ROHM does not grant you, explicitly or implicitly, any license to use or exercise intellectual property or other rights held by ROHM and other parties. ROHM shall bear no responsibility whatsoever for any dispute arising from the use of such technical information.

The Products specified in this document are intended to be used with general-use electronic equipment or devices (such as audio visual equipment, office-automation equipment, communication devices, electronic appliances and amusement devices).

The Products specified in this document are not designed to be radiation tolerant.

While ROHM always makes efforts to enhance the quality and reliability of its Products, a Product may fail or malfunction for a variety of reasons.

Please be sure to implement in your equipment using the Products safety measures to guard against the possibility of physical injury, fire or any other damage caused in the event of the failure of any Product, such as derating, redundancy, fire control and fail-safe designs. ROHM shall bear no responsibility whatsoever for your use of any Product outside of the prescribed scope or not in accordance with the instruction manual.

The Products are not designed or manufactured to be used with any equipment, device or system which requires an extremely high level of reliability the failure or malfunction of which may result in a direct threat to human life or create a risk of human injury (such as a medical instrument, transportation equipment, aerospace machinery, nuclear-reactor controller, fuel-controller or other safety device). ROHM shall bear no responsibility in any way for use of any of the Products for the above special purposes. If a Product is intended to be used for any such special purpose, please contact a ROHM sales representative before purchasing.

If you intend to export or ship overseas any Product or technology specified herein that may be controlled under the Foreign Exchange and the Foreign Trade Law, you will be required to obtain a license or permit under the Law.



Thank you for your accessing to ROHM product informations.
More detail product informations and catalogs are available, please contact us.



ROHM Customer Support System

<http://www.rohm.com/contact/>







Looking for pricing, stock, or lifecycle information?

Click below to explore more details on WIN SOURCE:

-  [View BD6081GU-E2 on WIN SOURCE](#)
-  [Rohm Semiconductor](#) Information

Optimize Your Supply Chain with WIN SOURCE Solutions

-  Global Sourcing Solution
-  Obsolete Management
-  Cost Control Management
-  Shortage Management
-  Alternative Solution
-  Excess Inventory Management