



**THE DATASHEET OF
EVQ-P7L01K**



3.5 mm×2.9 mm Side-operational SMD Light Touch Switches

Type: **EVQP7/EVQP3/EVQ9P7**

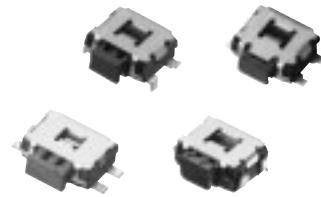

■ Features

- External dimensions : 3.5 mm×2.9 mm, Height 1.35 mm
- A wide range of terminal type : L-shape, J-bent, Straight
- High mount ability
- Push plate strength enhanced type

■ Recommended Applications

- Car navigation, Car audio

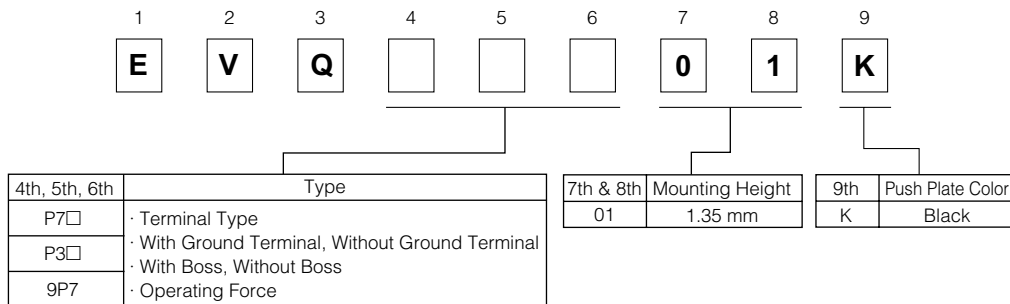

■ Explanation of Part Numbers



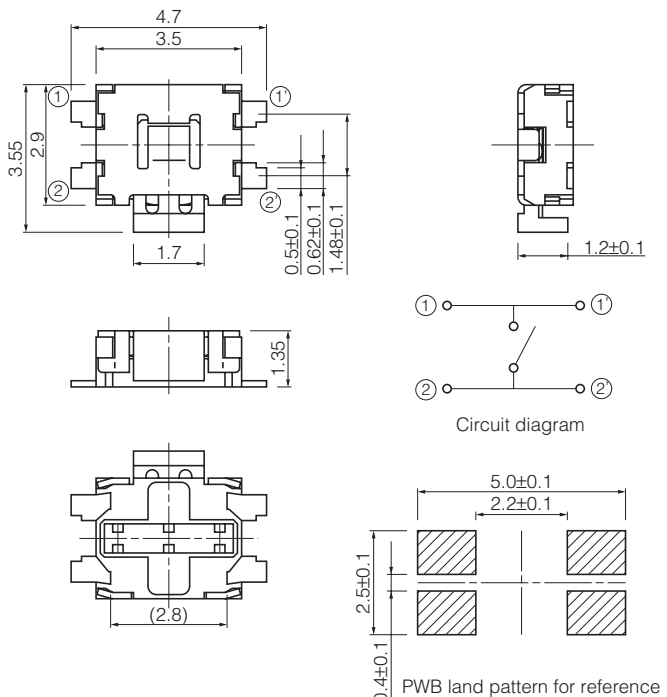

■ Specifications

Type	Snap action / Push-on type SPST	
Electrical	Rating	10 μA 2 Vdc to 50 mA 12 Vdc (Resistive load)
	Contact Resistance	500 mΩ max.
	Insulation Resistance	100 MΩ min. (at 100 Vdc)
	Dielectric Withstanding Voltage	250 Vac (1 minute)
	Bouncing	10 ms max. (ON, OFF)
Mechanical	Operating Force	1.6 N, 2.2 N
	Push Travel	0.2 mm
	Push Strength	30 N (1 minute)
Endurance	Operating Life	100000 cycles min.
Operating Temperature		-20 °C to +70 °C
Storage Temperature		-40 °C to +85 °C (Bulk) -20 °C to +60 °C (Taping)
Minimum Quantity/Packing Unit		5000 pcs. Embossed Taping (Reel Pack)
Quantity/Carton		25000 pcs.

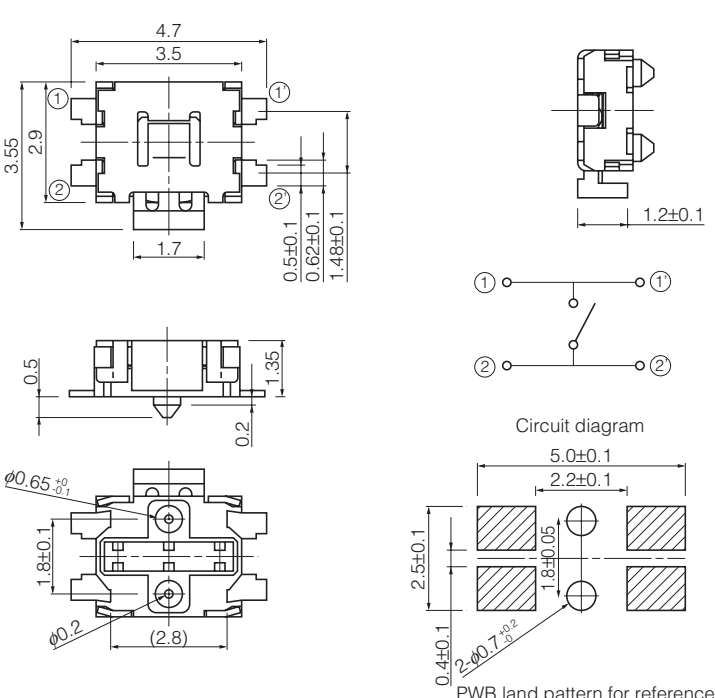
■ Dimensions in mm (not to scale)

<p>No. 1</p> <p>EVQP7A EVQP7J</p> <p>(Embossed Taping)</p> <p>With straight terminals Without boss</p> 				
<p>Part Numbers</p>	<p>Operating Force</p>	<p>Height</p>	<p>Push Plate Color</p>	<p>Operating Life</p>
<p>EVQP7A01K</p>	<p>2.2 N</p>	<p>1.35 mm</p>	<p>Black</p>	<p>100000 cycles</p>
<p>EVQP7J01K</p>	<p>1.6 N</p>	<p>1.35 mm</p>	<p>Black</p>	<p>100000 cycles</p>
<p>No. 2</p> <p>EVQP7C EVQP7L</p> <p>(Embossed Taping)</p> <p>With straight terminals With boss</p> 				
<p>Part Numbers</p>	<p>Operating Force</p>	<p>Height</p>	<p>Push Plate Color</p>	<p>Operating Life</p>
<p>EVQP7C01K</p>	<p>2.2 N</p>	<p>1.35 mm</p>	<p>Black</p>	<p>100000 cycles</p>
<p>EVQP7L01K</p>	<p>1.6 N</p>	<p>1.35 mm</p>	<p>Black</p>	<p>100000 cycles</p>

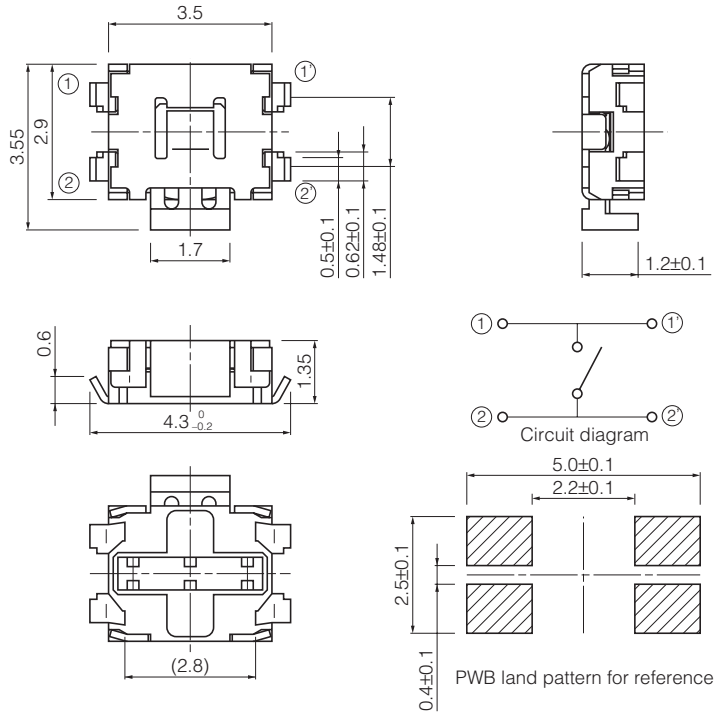
■ Dimensions in mm (not to scale)

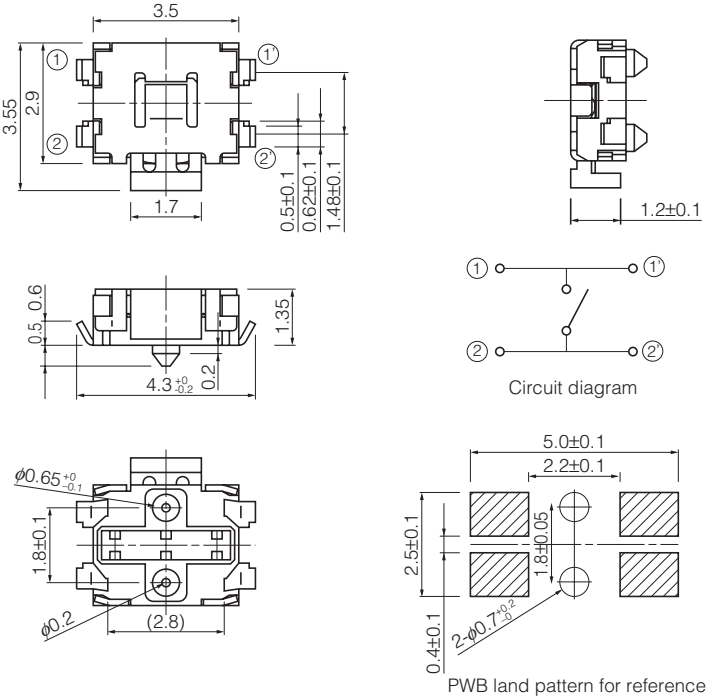
<p>No. 3</p> <p>EVQP7B EVQP7K</p> <p>(Embossed Taping)</p> <p>With J-bent terminals Without boss</p> 				
<p>Part Numbers</p>	<p>Operating Force</p>	<p>Height</p>	<p>Push Plate Color</p>	<p>Operating Life</p>
<p>EVQP7B01K</p>	<p>2.2 N</p>	<p>1.35 mm</p>	<p>Black</p>	<p>100000 cycles</p>
<p>EVQP7K01K</p>	<p>1.6 N</p>	<p>1.35 mm</p>	<p>Black</p>	<p>100000 cycles</p>
<p>No. 4</p> <p>EVQP7D EVQP7M</p> <p>(Embossed Taping)</p> <p>With J-bent terminals With boss</p> 				
<p>Part Numbers</p>	<p>Operating Force</p>	<p>Height</p>	<p>Push Plate Color</p>	<p>Operating Life</p>
<p>EVQP7D01K</p>	<p>2.2 N</p>	<p>1.35 mm</p>	<p>Black</p>	<p>100000 cycles</p>
<p>EVQP7M01K</p>	<p>1.6 N</p>	<p>1.35 mm</p>	<p>Black</p>	<p>100000 cycles</p>

■ Dimensions in mm (not to scale)

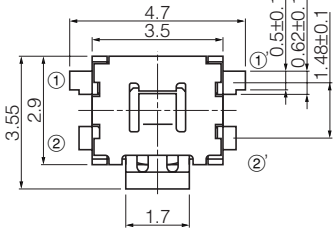
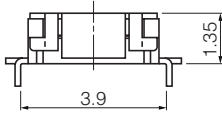
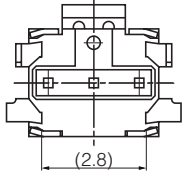
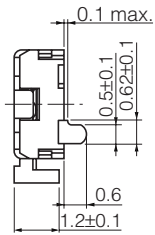
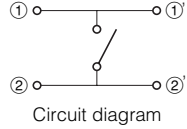
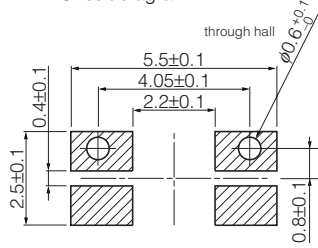
<p>No. 5</p> <p>EVQP3 EVQ9P</p> <p>(Embossed Taping)</p> <p>With L-shape terminals Without boss</p> 	  	  <p>Circuit diagram</p>  <p>PWB land pattern for reference</p>		
Part Numbers	Operating Force	Height	Push Plate Color	Operating Life
EVQP3401K	2.2 N	1.35 mm	Black	100000 cycles
EVQ9P701K	1.6 N	1.35 mm	Black	100000 cycles

■ Recommended Reflow Soldering Conditions

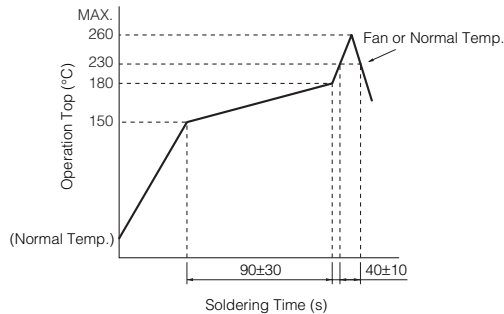

● Embossed Carrier Taping

Tape width=12.0 mm

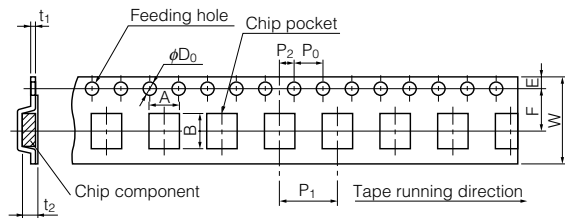

● Straight terminals, L-shape terminals type

Unit: mm

Part No.	Height	A	B	W	F	E	P ₁	P ₂	P ₀	D ₀ Dia.	t ₁	t ₂
EVQP7, EVQP3 EVQ9P7	1.35	5.2±0.2	4.5±0.2	12.0±0.3	5.5±0.1	1.75±0.10	8.0±0.1	2.0±0.1	4.0±0.1	1.5 ^{+0.1} ₋₀	0.3±0.1	1.5±0.2

● J-bent type

Unit: mm

Part No.	Height	A	B	W	F	E	P ₁	P ₂	P ₀	D ₀ Dia.	t ₁	t ₂
EVQP7, EVQP3	1.35	4.5±0.2	4.5±0.2	12.0±0.3	5.5±0.1	1.75±0.10	8.0±0.1	2.0±0.1	4.0±0.1	1.5 ^{+0.1} ₋₀	0.3±0.1	1.5±0.2

● Standard Reel Dimensions in mm (not to scale)

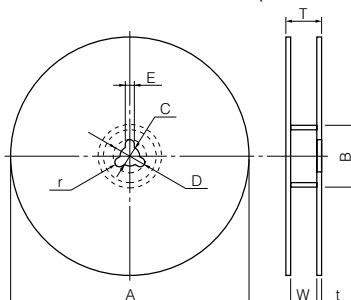

Item	A	B	C	D	E
Rate (mm)	φ380.0±2.0	φ80.0±1.0	φ13.0±0.5	φ21.0±1.0	2.0±0.5
Item	W	T	t	r	
Rate (mm)	13.5±1.0	17.5±1.0	1.0 to 3.0	1.0±0.5	

Looking for pricing, stock, or lifecycle information?

Click below to explore more details on WIN SOURCE:

 [View EVQ-P7L01K on WIN SOURCE](#)

 [Panasonic Information](#)

Optimize Your Supply Chain with WIN SOURCE Solutions

-  Global Sourcing Solution
-  Obsolete Management
-  Cost Control Management
-  Shortage Management
-  Alternative Solution
-  Excess Inventory Management