





**THE DATASHEET OF
ESD5Z5V0**



SPECIFICATION SHEET

SPECIFICATION SHEET NO.	N1004- SOD5235Z5V0SZF
DATE	Oct. 04, 2021
REVISION	A0
DESCRIPTION	<p>SMD Plastic-Encapsulate ESD Protection Diodes, SOD-523 series, 2 pads ESD5Z5V0 Type, TVs for ESD protection</p> <p>Reverse Working Voltage : 5.0V, Clamping Voltage 11.6VC Max.</p> <p>Operating Temp. Range -55°C ~+150°C, Package in Tape/Reel, 3000pcs/Reel RoHS/RoHS III compliant</p>
CUSTOMER	
CUSTOMER PART NUMBER	
CROSS REF. PART NUMBER	
ORIGINAL PART NUMBER	MDD ESD5Z5V0
PART CODE	SOD5235Z5V0SZF

VENDOR APPROVE			
Issued/Checked/Approved			
DATE: Oct. 04, 2021			

CUSTOMER APPROVE	
DATE:	

SMD ESD PROTECTION DIODES SOD-523 SERIES

MAIN FEATURE

- IEC61000-4-2 (ESD) level 4 ESD Protection
- Protects one directional I/O line
- Low clamping voltage
- Low leakage current
- Working voltages : 2.5V/3.3/5V/6V/7V/12V/15V
- Flammability Rating: UL 94V-0
- High temperature soldering recommended : 260°C/10s



APPLICATION

- Cell phone handsets and accessories
- Microprocessor based equipment
- Notebooks, Desktops, and Servers Cellular
- Personal digital assistants (PDA)
- Portable Instrumentation
- Peripherals

RFQ

[Request For Quotation](#)

PART CODE GUIDE

SOD523	5Z5V0	S	ZF
1	2	3	4

1) **SOD523**: SMD Plastic-Encapsulate ESD Protection Diodes, SOD-523 series, 2 pads

2) **5Z5V0**: Type code for original part number ESD5Z5V0

3) **S**: Package code, Package in Tape/Reel, 3000pcs/Reel

4) **ZF**: Marking code for “ZF” on the case surface, Different Marking for different specification.

MORE ITEMS AVAILABLE

SOD5235Z2V5SZD	SOD5235Z3V3SZE	SOD5235Z5V0SZF	SOD5235Z6V0SZG	SOD5235Z7V0SZH
SOD5235Z12VSZM	SOD5235Z15VSZN			

SMD ESD PROTECTION DIODES SOD-523 SERIES

DIMENSION (Unit: Inch/mm)

Image for reference

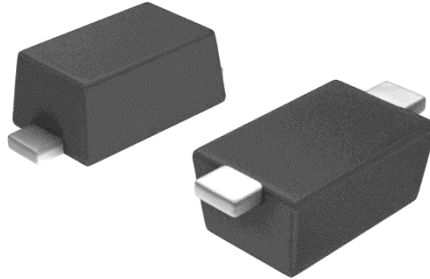

Marking: ZF

SOD-523

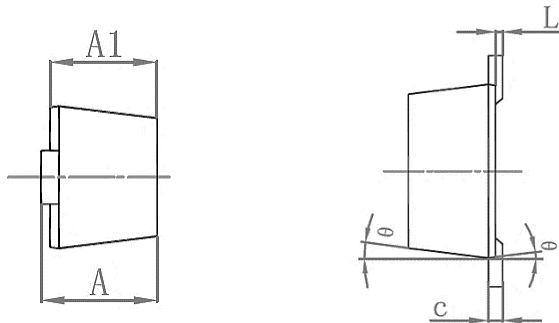
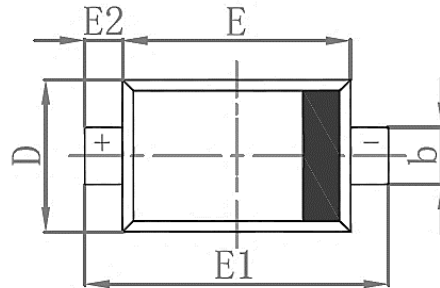

Symbol	Value (mm)		
	Min.	Typ.	Max.
A	0.51		0.770
A1	0.50		0.70
b	0.250		0.350
c	0.080		0.150
D	0.750		0.850
E	1.10		1.30
E1	1.50		1.70
E2	0.20 Ref.		
L	0.010		0.070
K	7° Ref.		

Recommend Pad Layout

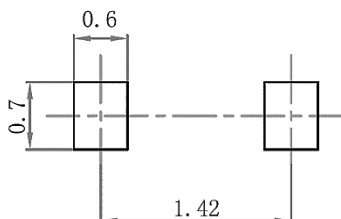

Circuit Diagram

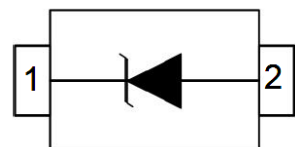

SMD ESD PROTECTION DIODES SOD-523 SERIES

MECHANICAL DATA

Case	Flammability Rating	Polarity	Mounting Position	Weight per piece
JEDEC SOT-523 molded plastic body	UL 94V - 0	-	-	-

ABSOLUTE MAX. RATINGS AT Ta=25 °C (unless otherwise specified)

Parameter	SYMBOLS	VALUE	UNITS
		LIMIT	
ESD per IEC 61000-4-2 (Air)	V ESD	+/-30	KV
ESD per IEC 61000-4-2 (Contact)	V ESD	+/-30	KV
ESD Voltage per human body model	ESD	16	KV
ESD Voltage per machine model	ESD	400	V
Total power dissipation on FR-5 Board (Note 1) @ Ta = 25°C	P D	150	mW
Operating Temperature Range	T J	-55 ~+ 150	°C
Storage Temperature Range	T STG	-55 ~ +150	°C
Lead Solder Temperature- Max. (10 s Duration)	T L	260 /10s	°C

Note: 1. FR-5=1.0x0.75x0.62 in.

SMD ESD PROTECTION DIODES SOD-523 SERIES

ELECTRICAL CHARACTERISTICS (Ta=25 °C unless otherwise specified)

Parameter	SYMBOLS	VALUE			UNITS
		Min.	Typical	Max.	
Reverse Working Voltage	V _{RWM}			5.0	V
Reverse Breakdown Voltage @ I _T = 1.0mA	V _{BR}	6.2			V
Reverse Leakage Current @V _{RWM} = 5.0V, t _p = 8/20μs	I _R			0.08	μA
Clamping Voltage @ I _{PP} = 5.0A, t _p = 8/20μs	V _C			11.6	V
Clamping Voltage @ I _{PP} = 9.4A, t _p = 8/20μs	V _C			18.6	V
Peak Pulse Power per @ t _p = 8/20μs	P _{PK}			174	W
Junction Capacitance	C _J			80	pF

SMD ESD PROTECTION DIODES SOD-523 SERIES
RELIABILITY

Number	Experiment Items	Experiment Method And Conditions	Reference Documents
1	Solder Resistance Test	Test 260°C± 5°C for 10 ± 2 sec. Immerse body into solder 1/16" ± 1/32"	MIL-STD-750D METHOD-2031.2
2	Solderability Test	230°C ±5°C for 5 sec.	MIL-STD-750D METHOD-2026.1 0
3	Pull Test	1 kg in axial lead direction for 10 sec.	MIL-STD-750D METHOD-2036.4
4	Bend Test	0.5Kg Weight Applied To Each Lead, Bending Arcs 90 °C ± 5 °C For 3 Times	MIL-STD-750D METHOD-2036.4
5	High Temperature Reverse Bias Test	TA=100°C for 1000 Hours at VR=80% Rated VR	MIL-STD-750D METHOD-1038.4
6	Forward Operation Life Test	TA=25°C Rated Average Rectified Current	MIL-STD-750D METHOD-1027.3
7	Intermittent Operation Life Test	On state: 5 min with rated IRMS Power Off state: 5 min with Cool Forced Air. On and off for 1000 cycles.	MIL-STD-750D METHOD-1036.3
8	Pressure Cooker Test	15 PSIG, TA=121°C, 4 hours	MIL-S-19500 APPENOIXC
9	Temperature Cycling Test	-55°C~+125°C; 30 Minutes For Dwelled Time 5 minutes for transferred time. Total: 10 cycles.	MIL-STD-750D METHOD-1051.7
10	Thermal Shock Test	0°C for 5 minutes., 100°C for 5minutes, Total: 10 cycles	MIL-STD-750D METHOD-1056.7
11	Forward Surge Test	8.3ms Single Sale Sine-wave One Surge.	MIL-STD-750D METHOD-4066.4
12	Humidity Test	TA=65°C, RH=98% for 1000 hours.	MIL-STD-750D METHOD-1021.3
13	High Temperature Storage life Test	150°C for 1000 Hours	MIL-STD-750D METHOD-1031.5

SMD ESD PROTECTION DIODES SOD-523 SERIES

SUGGESTED REFLOW PROFILE (For Reference Only)

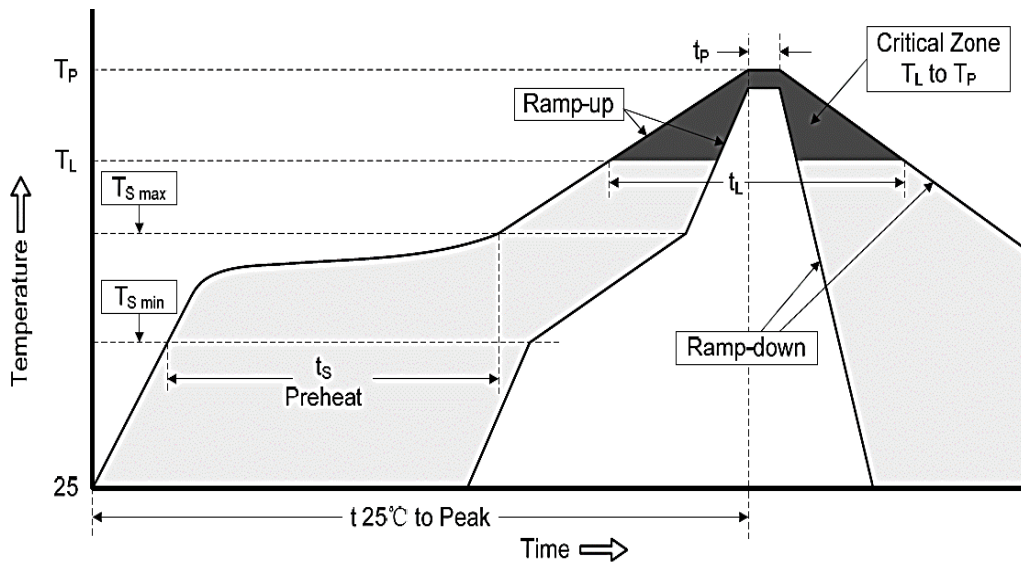

Profile Feature		Pb-Free Assembly
Average Ramp-up Rate (Ts Max to Tp)		3°C/second Max
Preheat	Temperature Min (Ts Min.)	150°C
	Temperature Max (Ts Max.)	200°C
	Time (ts Min. to ts Max.)	60 ~ 180 seconds
Time maintained above	Temperature (Tl)	217°C
	Time (tl)	60 ~ 150 seconds
Peak/Classification Temperature (Tp)		260 °C
Time within 5°C of actual Peak Temperature (tp)		20 ~ 40 seconds
Ramp-down rate		6 °C /Second Max.
Time 25 °C to Peak Temperature		8 minutes Max.
Suggest reflow times		3 Times Max.

SMD ESD PROTECTION DIODES SOD-523 SERIES

RATINGS AND CHARACTERISTIC CURVES (For Reference Only)

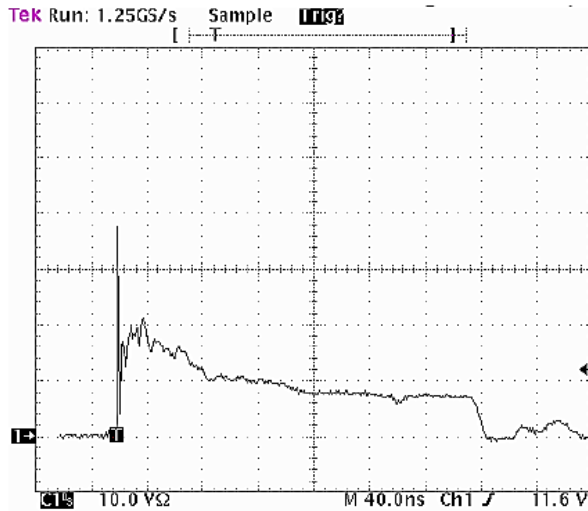

**Figure 1. ESD Clamping Voltage Screenshot
Positive 8 kV contact per IEC 61000-4-2**

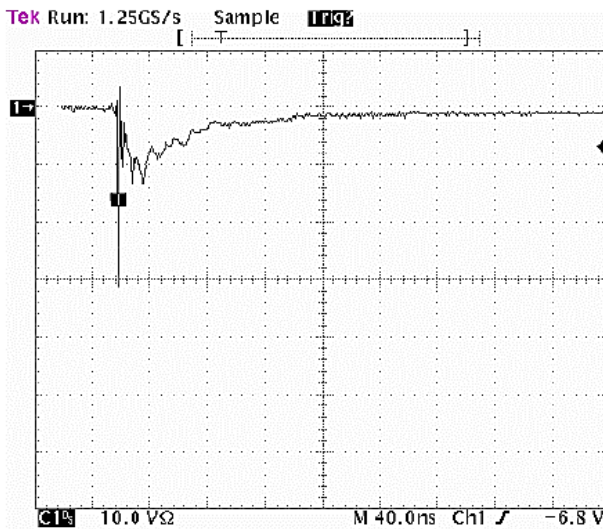
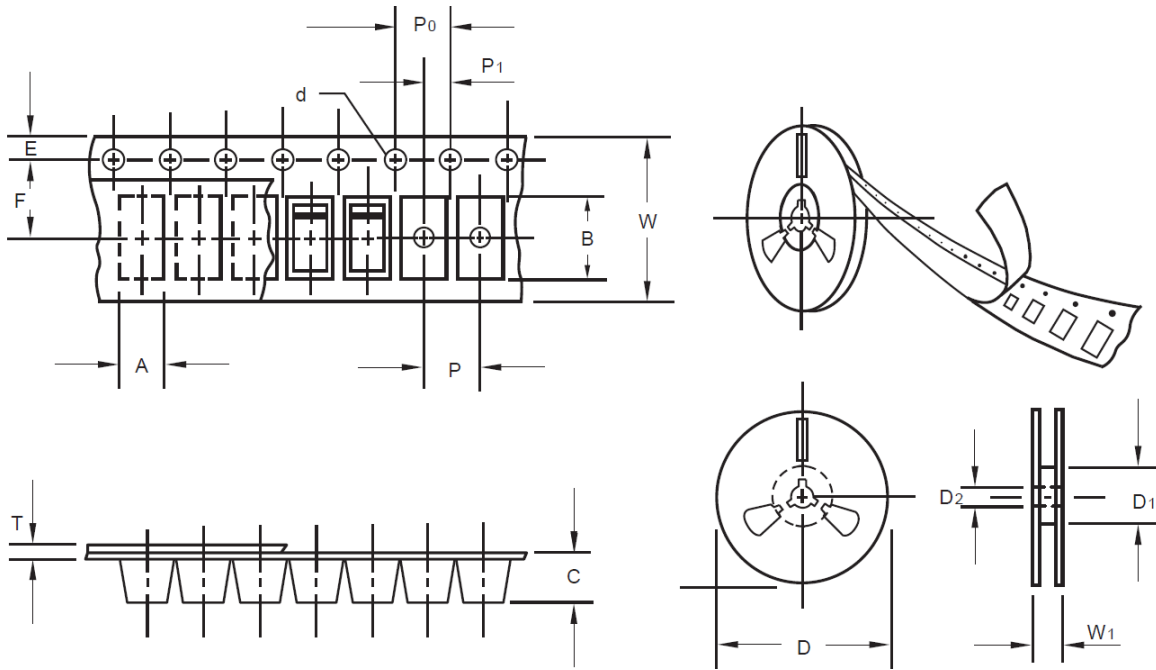

**Figure 2. ESD Clamping Voltage Screenshot
Negative 8 kV contact per IEC 61000-4-2**

SMD ESD PROTECTION DIODES SOD-523 SERIES

TAPE/REEL (Unit: mm)

All Devices are packed in accordance with EIA standard RS-481-A and specifications.



Item	Symbol	Tolerance	SOD-523
Carrier width	A	0.1	2.10
Carrier Length	B	0.1	4.00
Carrier Depth	C	0.1	1.60
Sprocket hole	d	0.05	1.55
7"Reel outside diameter	D	2.0	178.00
7"Reel inner diameter	D1	Min.	50.00
Feed hole diameter	D2	0.5	13.00
Sprocket hole position	E	0.1	1.75
Punch hole position	F	0.1	3.50
Punch hole pitch	P	0.1	4.00
Sprocket hole pitch	P0	0.1	4.00
Embossment center	P1	0.1	2.00
Overall tape thickness	T	0.1	0.25
Tape width	W	0.3	8.15
Reel width	W1	1.0	10.50

SMD ESD PROTECTION DIODES SOD-523 SERIES

SPQ PACKAGE for Reference

Item	Unit	Value
Case Code		SOD-523
Reel Size	Inch	7
Reel Size	mm	178
Tape Space	mm	/
SPQ /Reel	pcs	3000
Weigh /SPQ	LBS	
Weigh /SPQ	KGs	
Qty. Per Box	pcs	6,000
Inner Box	Inch	L8.0*W8.0*H1.5

DISCLAIMER

NextGen Component, Inc. reserves the right to make changes to the product(s) and or information contained herein without notice. No liability is assumed as a result of their use or application. No rights under any patent accompany the sale of any such product(s) or information



Looking for pricing, stock, or lifecycle information?

Click below to explore more details on WIN SOURCE:

 [View ESD5Z5V0 on WIN SOURCE](#)

 [MDD Information](#)

Optimize Your Supply Chain with WIN SOURCE Solutions

-  Global Sourcing Solution
-  Obsolete Management
-  Cost Control Management
-  Shortage Management
-  Alternative Solution
-  Excess Inventory Management