



**THE DATASHEET OF
DSC2042FI2-M0005**





Low-Jitter Configurable HCSL-LVPECL Oscillator

General Description

The DSC2042 series of high performance dual output oscillators utilize a proven silicon MEMS technology to provide excellent jitter and stability while incorporating additional device functionality. The two outputs are controlled by separate supply voltages to allow for high output isolation. The frequencies of the outputs can be identical or independently derived from a common PLL frequency source. The DSC2042 has provision for up to eight user-defined pre-programmed, pin selectable output frequency combinations.

DSC2042 is packaged in a 14-pin 3.2x2.5 mm QFN package and available in temperature grades from Ext. Commercial to Industrial.

Block Diagram

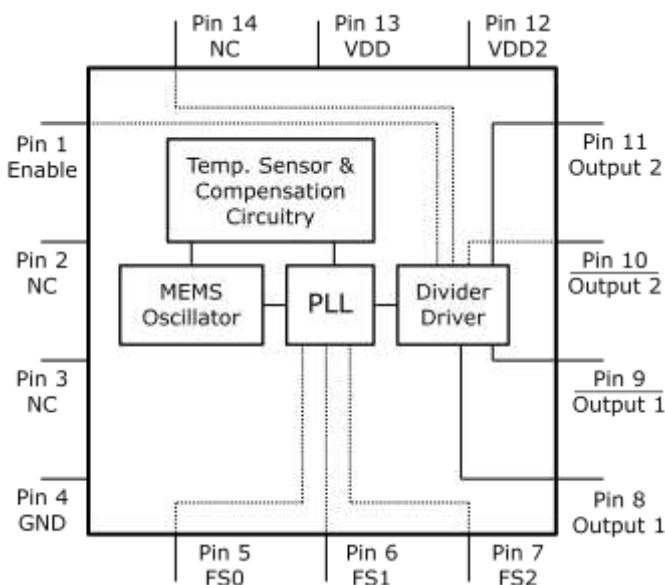

Features

- **Low RMS Phase Jitter: <1 ps (typ)**
- **High Stability: ± 10 , ± 25 , ± 50 ppm**
- **Wide Temperature Range**
 - Industrial: -40° to 85° C
 - Ext. commercial: -20° to 70° C
- **High Supply Noise Rejection: -50 dBc**
- **Two Independent Outputs**
 - HCSL & LVPECL
- **Pin-Selectable Configurations**
 - 3-bit Output Frequency Combinations
- **Short Lead Times: 2 Weeks**
- **Wide Freq. Range:**
 - HCSL Output: 2.3 – 460 MHz
 - LVPECL Output: 2.3 – 460 MHz
- **Miniature Footprint of 3.2x2.5mm**
- **Excellent Shock & Vibration Immunity**
 - Qualified to MIL-STD-883
- **High Reliability**
 - 20x better MTF than quartz oscillators
- **Supply Range of 2.25 to 3.6 V**
- **Lead Free & RoHS Compliant**

Applications

- **Storage Area Networks**
 - SATA, SAS, Fibre Channel
- **Passive Optical Networks**
 - EPON, 10G-EPON, GPON, 10G-PON
- **Ethernet**
 - 1G, 10GBASE-T/KR/LR/SR, and FCoE
- **HD/SD/SDI Video & Surveillance**
- **PCI Express**

Pin Description

Pin No.	Pin Name	Pin Type	Description
1	Enable	I	Enables outputs when high and disables when low
2	NC	NA	Leave unconnected or grounded
3	NC	NA	Leave unconnected or grounded
4	GND	Power	Ground
5	FS0	I	Least significant bit for frequency selection
6	FS1	I	Middle bit for frequency selection
7	FS2	I	Most significant bit for frequency selection
8	Output1+	O	Positive HCSL Output 1
9	Output1-	O	Negative HCSL Output 1
10	Output 2-	O	Negative LVPECL Output 2
11	Output 2+	O	Positive LVPECL Output 2
12	VDD2	Power	Power Supply 2 for HCSL Output 2
13	VDD	Power	Power Supply
14	NC	NA	Leave unconnected or grounded

Operational Description

The DSC2042 is a dual oscillator with an HCSL output and an LVPECL output. The device consists of a MEMS resonator and a support PLL IC. The two outputs are generated through independent 8-bit programmable dividers from the output of the internal PLL. Two constraints are imposed on the output frequencies: 1) $f_2 = M \times f_1 / N$, where M and N are even integers between 4 and 254, 2) $1.2\text{GHz} < N \times f_2 < 1.7\text{GHz}$.

The actual frequencies output by the DSC2042 are controlled by an internal pre-programmed

memory (OTP). This memory stores all coefficients required by the PLL for up to eight different frequency combinations. Three control pins (FS0 – FS2) select the output frequency combination. Discera supports customer defined versions of the DSC2042. Standard frequency options are described in in the following sections.

When Enable (pin 1) is floated or connected to VDD, the DSC2042 is in operational mode. Driving Enable to ground will tri-state both output drivers (hi-impedance mode).

Output Clock Frequencies

Table 1 lists the standard frequency configurations and the associated ordering information to be used in conjunction with the ordering code. Customer defined combinations are available.

Table 1. Pre-programmed pin-selectable output frequency combinations

Ordering Info	Freq (MHz)	Freq Select Bits [FS2, FS1, FS0] – Default is [111]							
		000	001	010	011	100	101	110	111
M0001	f _{OUT1}	156.25	0*	0*	0*	0*	0*	0*	100
	f _{OUT2}	125	0*	0*	0*	0*	0*	0*	156.25
M0002	f _{OUT1}	100	156.25	0*	0*	0*	0*	0*	0*
	f _{OUT2}	100	156.25	0*	0*	0*	0*	0*	0*
MXXXXX	f _{OUT1}	Contact factory for additional configurations.							
	f _{OUT2}								

Frequency select bit are weakly tied high so if left unconnected the default setting will be [111] and the device will output the associated frequency highlighted in **Bold**.

0* – denotes invalid selection, output frequency is not specified.

Absolute Maximum Ratings

Item	Min	Max	Unit	Condition
Supply Voltage	-0.3	+4.0	V	
Input Voltage	-0.3	V _{DD} +0.3	V	
Junction Temp	-	+150	°C	
Storage Temp	-55	+150	°C	
Soldering Temp	-	+260	°C	40sec max.
ESD	-		V	
HBM		4000		
MM		400		
CDM		1500		

Note: 1000+ years of data retention on internal memory

Ordering Code

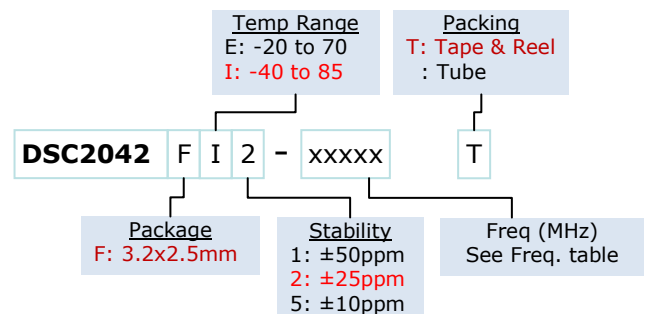

Specifications (Unless specified otherwise: T=25° C)

Parameter		Condition	Min.	Typ.	Max.	Unit
Supply Voltage ¹	V _{DD}		2.25		3.6	V
Supply Current	I _{DD}	EN pin low – outputs are disabled		21	23	mA
Supply Current ²	I _{DD}	EN pin high – outputs are enabled R _L =50Ω, F _{O1} = F _{O2} =156.25 MHz		76		mA
Frequency Stability	Δf	Includes frequency variations due to initial tolerance, temp. and power supply voltage			±10 ±25 ±50	ppm
Aging	Δf	1 year @25°C			±5	ppm
Startup Time ³	t _{SU}	T=25°C			5	ms
Input Logic Levels Input logic high Input logic low	V _{IH} V _{IL}		0.75xV _{DD} -		- 0.25xV _{DD}	V
Output Disable Time ⁴	t _{DA}				5	ns
Output Enable Time	t _{EN}				20	ns
Pull-Up Resistor ²		Pull-up exists on all digital IO		40		kΩ
LVPECL Outputs						
Output Logic Levels Output logic high Output logic low	V _{OH} V _{OL}	R _L =50Ω	V _{DD} -1.08 -		- V _{DD} -1.55	V
Pk to Pk Output Swing		Single-Ended		800		mV
Output Transition time ⁴ Rise Time Fall Time	t _R t _F	20% to 80% R _L =50Ω		250		ps
Frequency	f ₀	Single Frequency	2.3		460	MHz
Output Duty Cycle	SYM	Differential	48		52	%
Period Jitter ⁵	J _{PER}	F _{O1} =125 MHz		2.5		ps _{RMS}
Integrated Phase Noise	J _{CC}	200kHz to 20MHz @156.25MHz 100kHz to 20MHz @156.25MHz 12kHz to 20MHz @156.25MHz		0.25 0.38 1.7	2	ps _{RMS}
HCSL Outputs						
Output Logic Levels Output logic high Output logic low	V _{OH} V _{OL}	R _L =50Ω	0.725 -		- 0.1	V
Pk to Pk Output Swing		Single-Ended		750		mV
Output Transition time ⁴ Rise Time Fall Time	t _R t _F	20% to 80% R _L =50Ω, C _L = 2pF		200	400	ps
Frequency	f ₀	Single Frequency	2.3		460	MHz
Output Duty Cycle	SYM	Differential	48		52	%
Period Jitter ⁵	J _{PER}	F _{O1} =F _{O2} =156.25 MHz		2.8		ps _{RMS}
Integrated Phase Noise	J _{PH}	200kHz to 20MHz @156.25MHz 100kHz to 20MHz @156.25MHz 12kHz to 20MHz @156.25MHz		0.25 0.37 1.7	2	ps _{RMS}

Notes:

1. Pin 4 V_{DD} should be filtered with 0.01uF capacitor.
2. Output is enabled if Enable pad is floated or not connected.
3. t_{SU} is time to 100PPM stable output frequency after V_{DD} is applied and outputs are enabled.
4. Output Waveform and Test Circuit figures below define the parameters.
5. Period Jitter includes crosstalk from adjacent output.

Output Waveform: HCSL

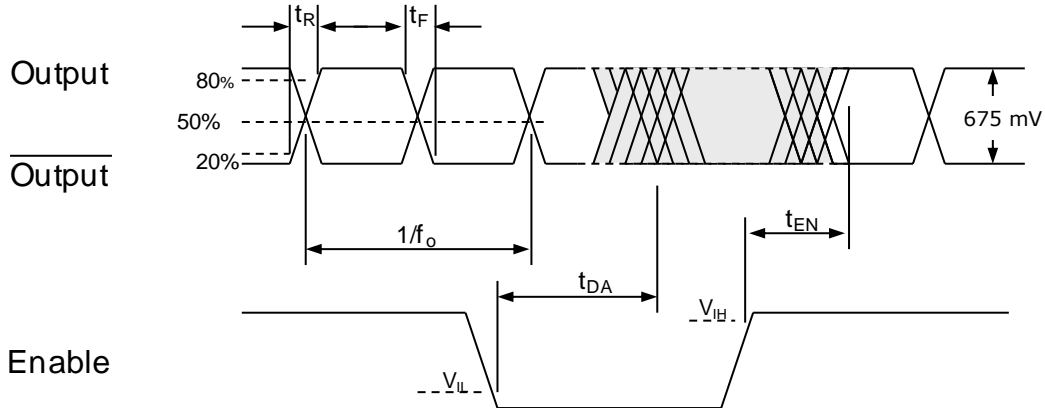

Output Waveform: LVPECL

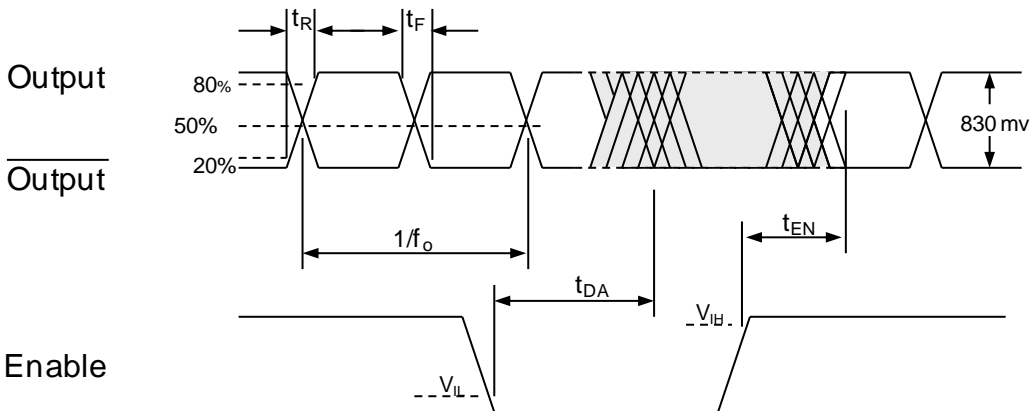

Solder Reflow Profile

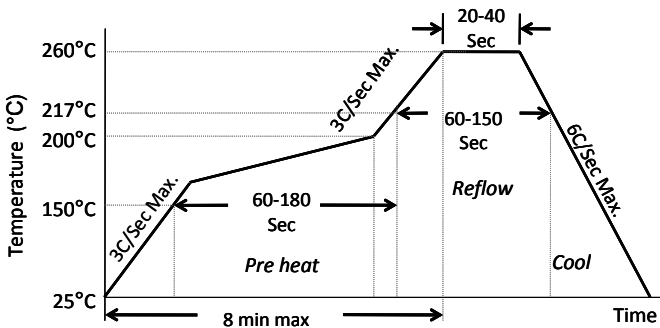

MSL 1 @ 260°C refer to JSTD-020C	
Ramp-Up Rate (200°C to Peak Temp)	3°C/Sec Max.
Preheat Time 150°C to 200°C	60-180 Sec
Time maintained above 217°C	60-150 Sec
Peak Temperature	255-260°C
Time within 5°C of actual Peak	20-40 Sec
Ramp-Down Rate	6°C/Sec Max.
Time 25°C to Peak Temperature	8 min Max.

Package Dimensions

3.2 x 2.5 mm 14 Lead Plastic Package

External Dimensions

units: mm[inch]

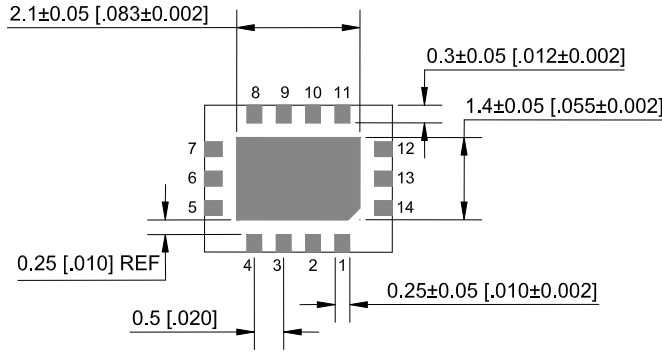
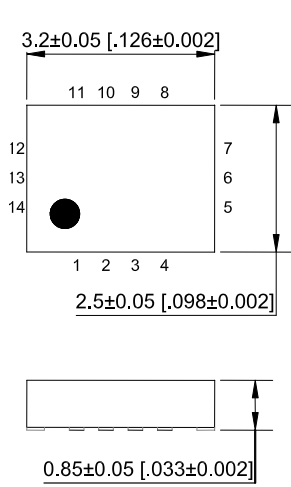

Recommended Solder Pad Layout

units: mm[inch]

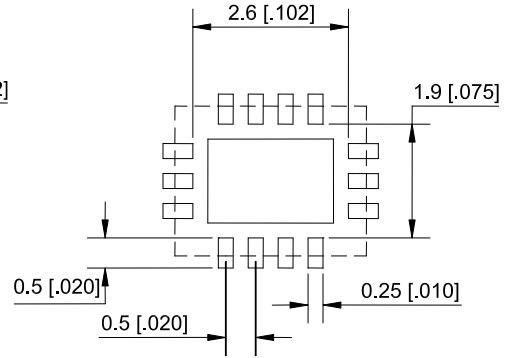

Disclaimer:

Micrel makes no representations or warranties with respect to the accuracy or completeness of the information furnished in this data sheet. This information is not intended as a warranty and Micrel does not assume responsibility for its use. Micrel reserves the right to change circuitry, specifications and descriptions at any time without notice. No license, whether express, implied, arising by estoppel or otherwise, to any intellectual property rights is granted by this document. Except as provided in Micrel's terms and conditions of sale for such products, Micrel assumes no liability whatsoever, and Micrel disclaims any express or implied warranty relating to the sale and/or use of Micrel products including liability or warranties relating to fitness for a particular purpose, merchantability, or infringement of any patent, copyright or other intellectual property right.

Micrel Products are not designed or authorized for use as components in life support appliances, devices or systems where malfunction of a product can reasonably be expected to result in personal injury. Life support devices or systems are devices or systems that (a) are intended for surgical implant into the body or (b) support or sustain life, and whose failure to perform can be reasonably expected to result in a significant injury to the user. A Purchaser's use or sale of Micrel Products for use in life support appliances, devices or systems is a Purchaser's own risk and Purchaser agrees to fully indemnify Micrel for any damages resulting from such use or sale.

Looking for pricing, stock, or lifecycle information?

Click below to explore more details on WIN SOURCE:

- ⊖ [View DSC2042FI2-M0005 on WIN SOURCE](#)
- ⊖ [Microchip Technology](#) Information

Optimize Your Supply Chain with WIN SOURCE Solutions

- ✓ Global Sourcing Solution
- ✓ Obsolete Management
- ✓ Cost Control Management
- ✓ Shortage Management
- ✓ Alternative Solution
- ✓ Excess Inventory Management