



**THE DATASHEET OF  
DSC2030FI2-C0002**





## Low-Jitter Configurable LVDS Oscillator

### General Description

The DSC2030 series of high performance LVDS oscillators utilize a proven silicon MEMS technology to provide excellent jitter and stability while incorporating additional device functionality. The DSC2030 allows the user to easily modify the frequency of the oscillator using pins. The DSC2030 has provision for up to four user-defined pre-programmed, pin-selectable output frequencies.

DSC2030 is packaged in a 14-pin 3.2x2.5 mm QFN package and available in temperature grades from Ext. Commercial to Automotive.

### Block Diagram

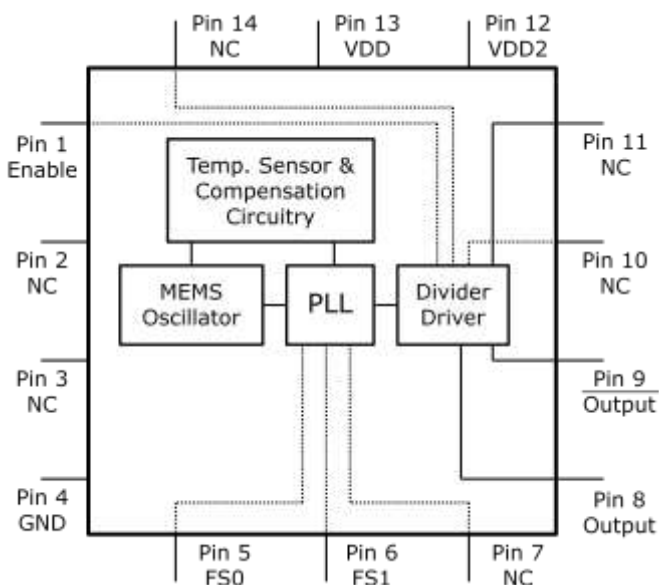

### Features

- **Low RMS Phase Jitter: <1 ps (typ)**
- **High Stability: ±10, ±25, ±50 ppm**
- **Wide Temperature Range**
  - Industrial: -40° to 85° C
  - Ext. commercial: -20° to 70° C
- **High Supply Noise Rejection: -50 dBc**
- **4 Pin-Selectable Output Frequencies**
- **Short Lead Times: 2 Weeks**
- **Wide Freq. Range:**
  - LVDS Output: 2.3 to 460 MHz
- **Miniature Footprint of 3.2x2.5mm**
- **Excellent Shock & Vibration Immunity**
  - Qualified to MIL-STD-883
- **High Reliability**
  - 20x better MTF than quartz oscillators
- **Supply Range of 2.25 to 3.6 V**
- **Lead Free & RoHS Compliant**

### Applications

- **Consumer Electronics**
- **Storage Area Networks**
  - SATA, SAS, Fibre Channel
- **Passive Optical Networks**
  - EPON, 10G-EPON, GPON, 10G-PON
- **Ethernet**
  - 1G, 10GBASE-T/KR/LR/SR, and FCoE
- **HD/SD/SDI Video & Surveillance**
- **PCI Express**

## Pin Description

Pin No.	Pin Name	Pin Type	Description
1	Enable	I	Enables outputs when high and disables when low
2	NC	NA	Leave unconnected or grounded
3	NC	NA	Leave unconnected or grounded
4	GND	Power	Ground
5	FS0	I	Least significant bit for frequency selection
6	FS1	I	Most significant bit for frequency selection
7	NC	NA	Leave unconnected or grounded
8	Output+	O	Positive LVDS Output
9	Output-	O	Negative LVDS Output
10	NC	NA	Leave unconnected or grounded
11	NC	NA	Leave unconnected or grounded
12	VDD2	Power	Power Supply
13	VDD	Power	Power Supply
14	NC	NA	Leave unconnected or grounded

## Operational Description

The DSC2030 is a LVDS oscillator consisting of a MEMS resonator and a support PLL IC. The LVDS output is generated through independent 8-bit programmable dividers from the output of the internal PLL.

The actual frequency output by the DSC2030 is controlled by an internal pre-programmed memory (OTP). This memory stores all coefficients required by the PLL for up to four

different frequencies. Two control pins (FS0 – FS1) select the output frequency. Discera supports customer defined versions of the DSC2030. Standard frequency options are described in the following sections.

When Enable (pin 1) is floated or connected to VDD, the DSC2030 is in operational mode. Driving Enable to ground will tri-state output driver (hi-impedance mode).

## Output Clock Frequencies

Table 1 lists the standard frequency configurations and the associated ordering information to be used in conjunction with the ordering code. Customer defined combinations are available.

Table 1. Pre-programmed pin-selectable output frequency combinations

Ordering Info	Freq (MHz)	Freq Select Bits [FS1, FS0] – <b>Default is [11]</b>			
		00	01	10	<b>11</b>
C0001	$f_{OUT}$	148.35165	74.17582	148.5	<b>74.25</b>
C0002	$f_{OUT}$	100	0*	0*	<b>100</b>
C0003	$f_{OUT}$	100	150	156.25	<b>312.5</b>
C0004	$f_{OUT}$	148.5	148.35	0*	<b>0*</b>
C0005	$f_{OUT}$	315	0*	0*	<b>315</b>
C000X	$f_{OUT}$	Contact factory for additional configurations.			

Frequency select bit are weakly tied high so if left unconnected the default setting will be [11] and the device will output the associated frequency highlighted in **Bold**.

0\* – denotes invalid selection, output frequency is not specified.

## Absolute Maximum Ratings

Item	Min	Max	Unit	Condition
Supply Voltage	-0.3	+4.0	V	
Input Voltage	-0.3	$V_{DD}+0.3$	V	
Junction Temp	-	+150	°C	
Storage Temp	-55	+150	°C	
Soldering Temp	-	+260	°C	40sec max.
ESD	-		V	
	HBM	4000		
	MM	400		
CDM	1500			

Note: 1000+ years of data retention on internal memory

## Ordering Code

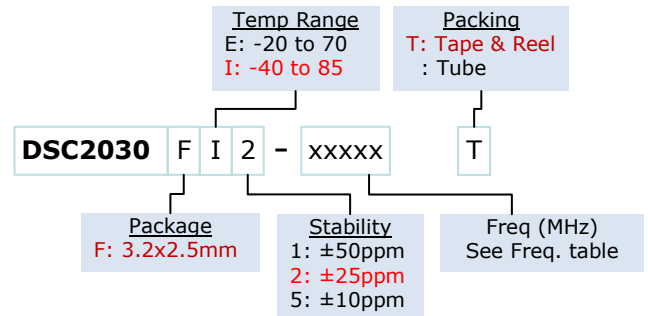

## Specifications (Unless specified otherwise: T=25° C)

Parameter		Condition	Min.	Typ.	Max.	Unit
Supply Voltage <sup>1</sup>	$V_{DD}$		2.25		3.6	V
Supply Current	$I_{DD}$	EN pin low – output is disabled		21	23	mA
Supply Current <sup>2</sup>	$I_{DD}$	EN pin high – outputs are enabled $R_L=100\Omega$ , $F_0=156.25$ MHz		29	32	mA
Frequency Stability	$\Delta f$	Includes frequency variations due to initial tolerance, temp. and power supply voltage			±10 ±25 ±50	ppm
Aging	$\Delta f$	1 year @25°C			±5	ppm
Startup Time <sup>3</sup>	$t_{SU}$	T=25°C			5	ms
Input Logic Levels						
Input logic high	$V_{IH}$		0.75x $V_{DD}$		-	V
Input logic low	$V_{IL}$		-		0.25x $V_{DD}$	
Output Disable Time <sup>4</sup>	$t_{DA}$				5	ns
Output Enable Time	$t_{EN}$				20	ns
Pull-Up Resistor <sup>2</sup>		Pull-up exists on all digital IO		40		k $\Omega$
<b>LVDS Output</b>						
Output Offset Voltage		R=100 $\Omega$ Differential	1.125		1.4	V
Delta Offset Voltage					50	mV
Pk to Pk Output Swing		Single-Ended		350		mV
Output Transition time <sup>4</sup>						
Rise Time	$t_R$	20% to 80% $R_L=100\Omega$ , $C_L=2$ pF		200	350	ps
Fall Time	$t_F$					
Frequency	$f_0$	Single Frequency	2.3		460	MHz
Output Duty Cycle	SYM	Differential	48		52	%
Period Jitter <sup>5</sup>	$J_{PER}$	$F_0=156.25$ MHz		2.5		ps <sub>RMS</sub>
Integrated Phase Noise	$J_{CC}$	200kHz to 20MHz @156.25MHz 100kHz to 20MHz @156.25MHz 12kHz to 20MHz @156.25MHz		0.28 0.4 1.7	2	ps <sub>RMS</sub>

### Notes:

- Pin 4  $V_{DD}$  should be filtered with 0.01uF capacitor.
- Output is enabled if Enable pad is floated or not connected.
- $t_{SU}$  is time to 100PPM stable output frequency after  $V_{DD}$  is applied and outputs are enabled.
- Output Waveform and Test Circuit figures below define the parameters.
- Period Jitter includes crosstalk from adjacent output.

### Nominal Performance Parameters (Unless specified otherwise: $T=25^{\circ}C$ , $V_{DD}=3.3V$ )

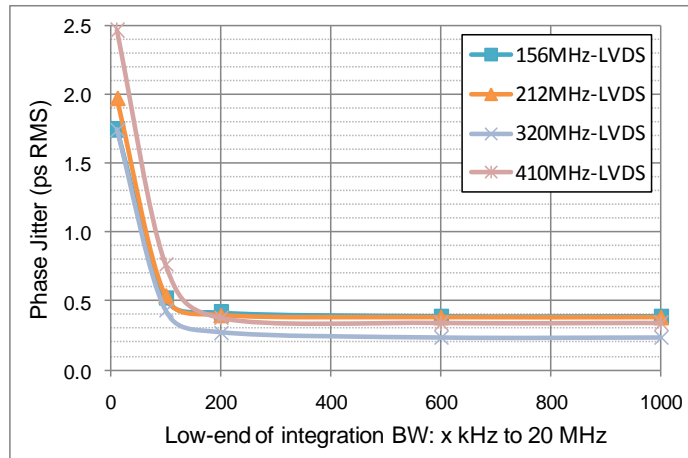

LVDS Phase jitter (integrated phase noise)

### Output Waveform: LVDS

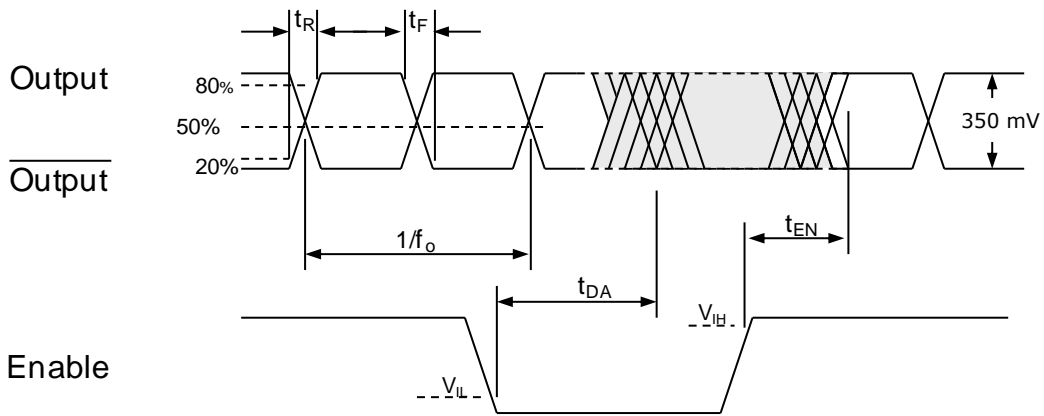

## Solder Reflow Profile

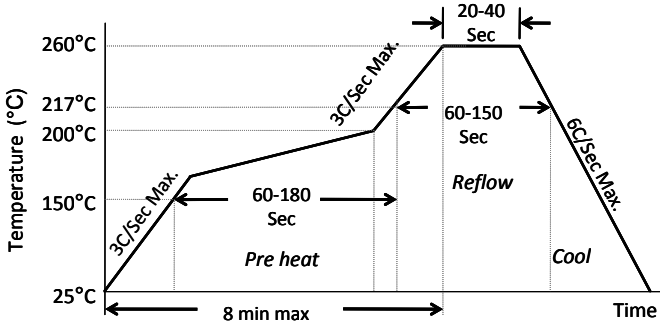

MSL 1 @ 260°C refer to JSTD-020C	
Ramp-Up Rate (200°C to Peak Temp)	3°C/Sec Max.
Preheat Time 150°C to 200°C	60-180 Sec
Time maintained above 217°C	60-150 Sec
Peak Temperature	255-260°C
Time within 5°C of actual Peak	20-40 Sec
Ramp-Down Rate	6°C/Sec Max.
Time 25°C to Peak Temperature	8 min Max.

## Package Dimensions

### 3.2 x 2.5 mm 14 Lead Plastic Package

#### External Dimensions

units: mm[inch]

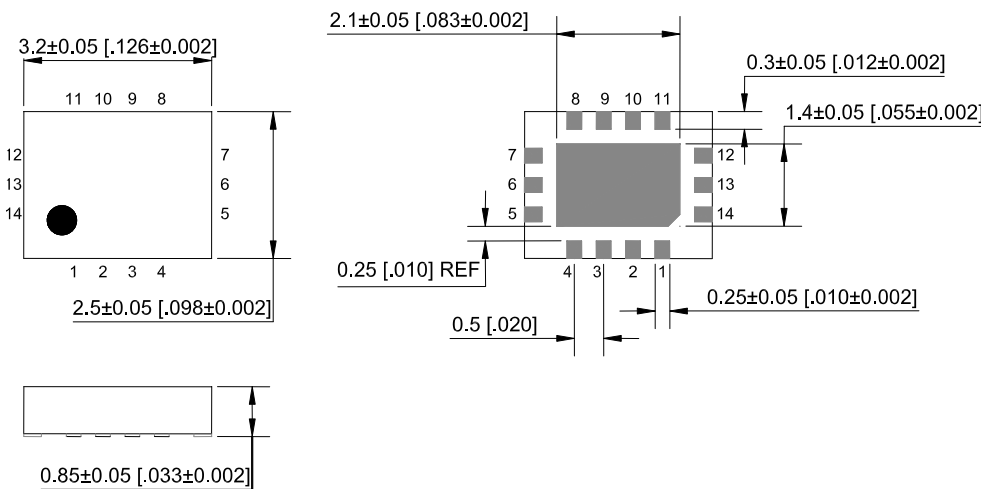

#### Recommended Solder Pad Layout

units: mm[inch]

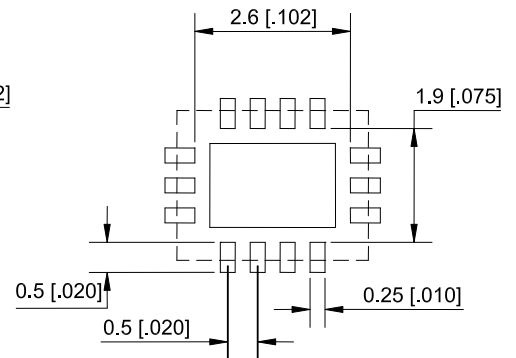

## Disclaimer:

Micrel makes no representations or warranties with respect to the accuracy or completeness of the information furnished in this data sheet. This information is not intended as a warranty and Micrel does not assume responsibility for its use. Micrel reserves the right to change circuitry, specifications and descriptions at any time without notice. No license, whether express, implied, arising by estoppel or otherwise, to any intellectual property rights is granted by this document. Except as provided in Micrel's terms and conditions of sale for such products, Micrel assumes no liability whatsoever, and Micrel disclaims any express or implied warranty relating to the sale and/or use of Micrel products including liability or warranties relating to fitness for a particular purpose, merchantability, or infringement of any patent, copyright or other intellectual property right.

Micrel Products are not designed or authorized for use as components in life support appliances, devices or systems where malfunction of a product can reasonably be expected to result in personal injury. Life support devices or systems are devices or systems that (a) are intended for surgical implant into the body or (b) support or sustain life, and whose failure to perform can be reasonably expected to result in a significant injury to the user. A Purchaser's use or sale of Micrel Products for use in life support appliances, devices or systems is a Purchaser's own risk and Purchaser agrees to fully indemnify Micrel for any damages resulting from such use or sale.

## Looking for pricing, stock, or lifecycle information?

Click below to explore more details on WIN SOURCE:

 [View DSC2030FI2-C0002 on WIN SOURCE](#)

 [Microchip Technology](#) Information

## Optimize Your Supply Chain with WIN SOURCE Solutions

-  Global Sourcing Solution
-  Obsolete Management
-  Cost Control Management
-  Shortage Management
-  Alternative Solution
-  Excess Inventory Management