



**THE DATASHEET OF
DSC1030BC1-030.0000T**





3.0V

Low-Power CMOS Oscillator

General Description

The DSC1030 is a 3.0V fixed frequency MEMS based PureSilicon™ Oscillator. It can be factory programmed to any frequency from 1 to 150MHz.

The DSC1030 incorporates an all silicon resonator that is extremely robust and nearly immune to stress related fractures, common to crystal based oscillators. Without sacrificing the performance and stability required of today's systems, a crystal-less design allows for a higher level of reliability, making the DSC1030 ideal for rugged, industrial, and portable applications where stress, shock, and vibration can damage quartz crystal based systems.

Available in industry standard packages, the DSC1030 can be "dropped-in" to the same PCB footprint as standard crystal oscillators.

Features

- Frequency Range: 1 to 150MHz
- Exceptional Stability over Temperature
 - ± 25 PPM, ± 50 PPM
- Operating voltage
 - 2.7 to 3.3V
- Operating Temperature Range
 - Industrial -40°C to 85°C
 - Ext. Commercial -20°C to 70°C
 - Commercial 0°C to 70°C
- Low Operating and Standby Current
 - 3mA Operating (40MHz)
 - 1uA Standby
- Ultra Miniature Footprint
 - $2.5 \times 2.0 \times 0.85$ mm
 - $3.2 \times 2.5 \times 0.85$ mm
 - $5.0 \times 3.2 \times 0.85$ mm
 - $7.0 \times 5.0 \times 0.85$ mm
- Excellent Shock and Vibration Resistance
- Lead Free, RoHS & Reach SVHC Compliant

Block Diagram

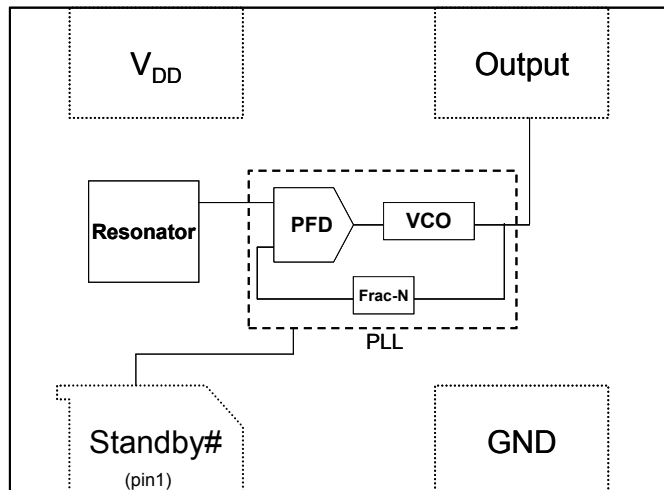

Benefits

- Pin for pin "drop in" replacement for industry standard oscillators
- Semiconductor level reliability, significantly higher than quartz
- Short mass production lead-times
- Longer Battery Life / Reduced Power
- Compact Plastic package
- Cost Effective

Applications

- Mobile Applications
- Consumer Electronics
- Portable Electronics
- CCD Clock for VTR Cameras
- Low Profile Applications
- Industrial

Absolute Maximum Ratings¹

Item	Min.	Max	Unit	Condition
Input Voltage	-0.3	VDD+0.3	V	
Junction Temp	-	+150	°C	
Storage Temp	-55	+150	°C	
Soldering Temp	-	+260	°C	40 sec max.
ESD	-		V	
HBM		2000		
MM		200		
CDM		500		

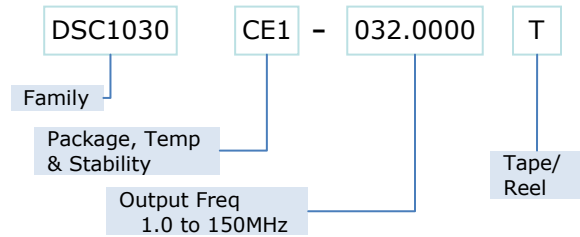

* See Ordering Information for details

Ordering Code

Recommended Operating Conditions

Parameter	Symbol	Range
Supply Voltage	V _{DD}	2.7 to 3.3V
Output Load	Z _L	R>10KΩ, C≤15pF
Operating Temperature	T	-40 – +85 °C
Option 1		-20 – +70 °C
Option 2		0 – +70 °C
Option 3		

Specifications

Parameter	Symbol	Condition	Min.	Typ.	Max.	Unit
Frequency	f ₀	Single Frequency	1		150	MHz
Frequency Tolerance						
Option 1		-40°C to +85°C			±25, ±50	ppm
Option 2		-20°C to +70°C			±25, ±50	
Option 3		0°C to +70°C			±25, ±50	
Supply Current, no load	I _{DD}	C _L =0p R _L =∞ T=25° C	1 to 40MHz 40 to 80MHz 80 to 125MHz 125 to 150MHz	3 4 5 6	10	mA
Supply Current, standby	I _{DD}	T=25°C			1.0	uA
Output Logic Levels						
Output logic high	V _{OH}	C _L =15pF	0.8*V _{DD}		-	Volts
Output logic low	V _{OL}		-		0.2*V _{DD}	
Output Transition time						
Rise Time	t _R	C _L =15pF; T=25°C		1.3	2	ns
Fall Time	t _F	20%/80%*V _{DD}		1.3	2	
Output Startup Time ²	t _{SU}	T=25°C		1.5	3	ms
Output Disable Time	t _{DA}			20	100	ns
Output Duty Cycle	SYM		45		55	%
Input Logic Levels						
Input logic high	V _{IH}		0.75*V _{DD}		-	Volts
Input logic low	V _{IL}		-		0.25*V _{DD}	
Jitter, Cycle to Cycle	J _{CC}	F = 100MHz ³		95		ps

Notes:

1. Absolute maximum ratings are those values beyond which the safety of the device cannot be guaranteed. The device should not be operated beyond these limits.
2. t_{SU} is time to stable output frequency after V_{DD} is applied. t_{SU} and t_{EN} (after EN is asserted) are identical values.
3. See typical cycle to cycle jitter graph for frequency dependence.

Nominal Performance Characteristics

3.0V Characteristics

Supply Current

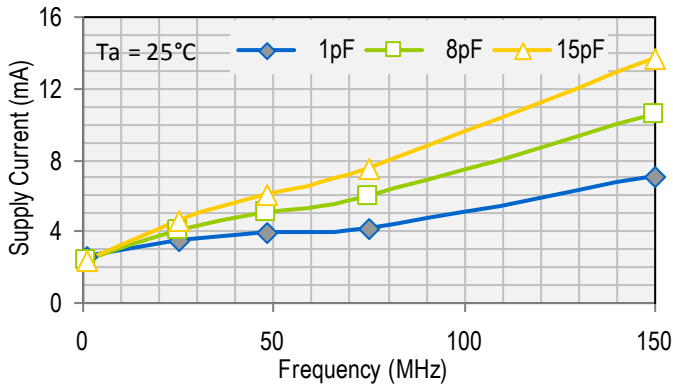

Standby Current

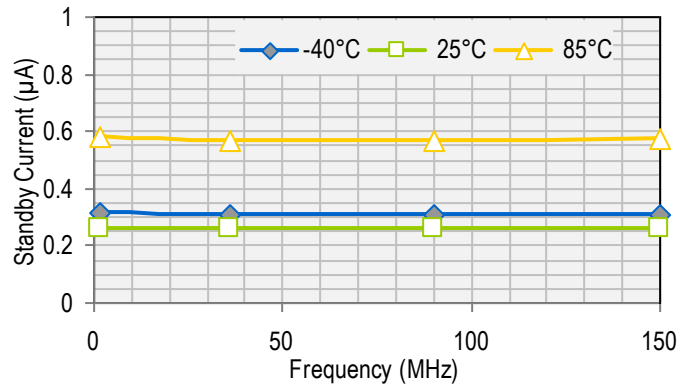

Rise Time

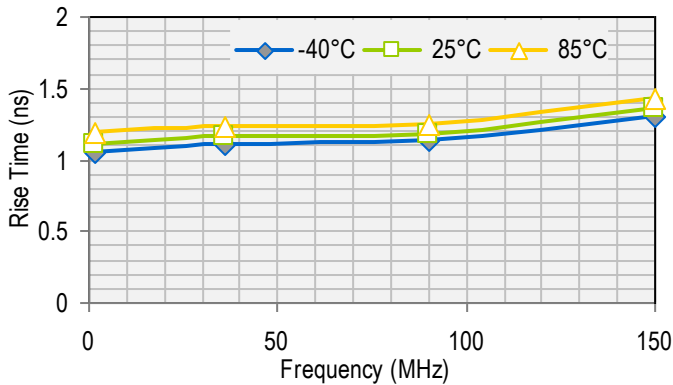

Fall Time

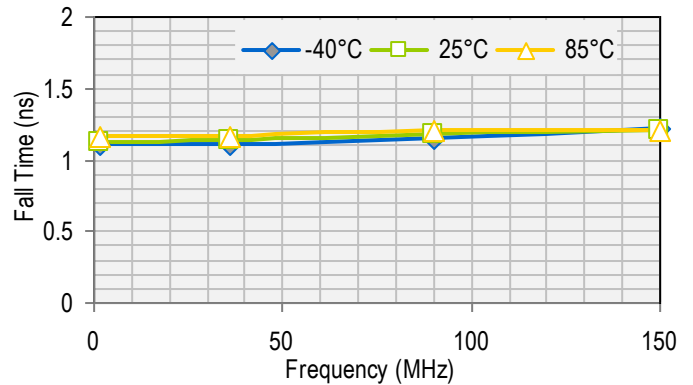

Period Jitter

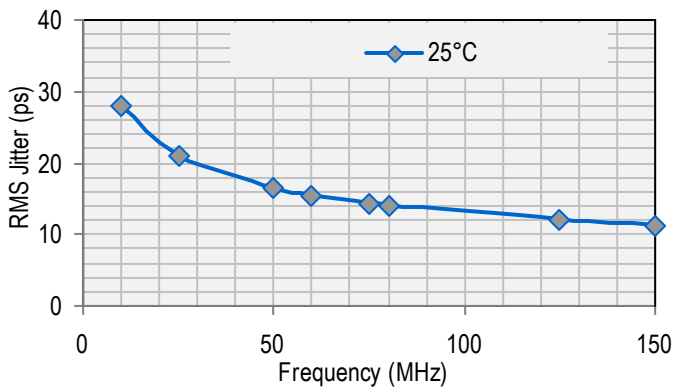

Cycle to Cycle Jitter

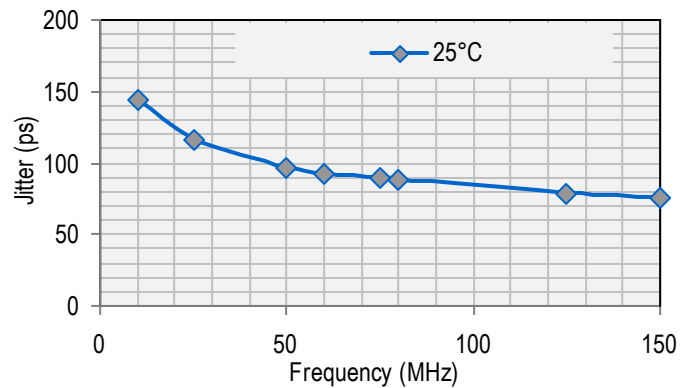

Output Waveform

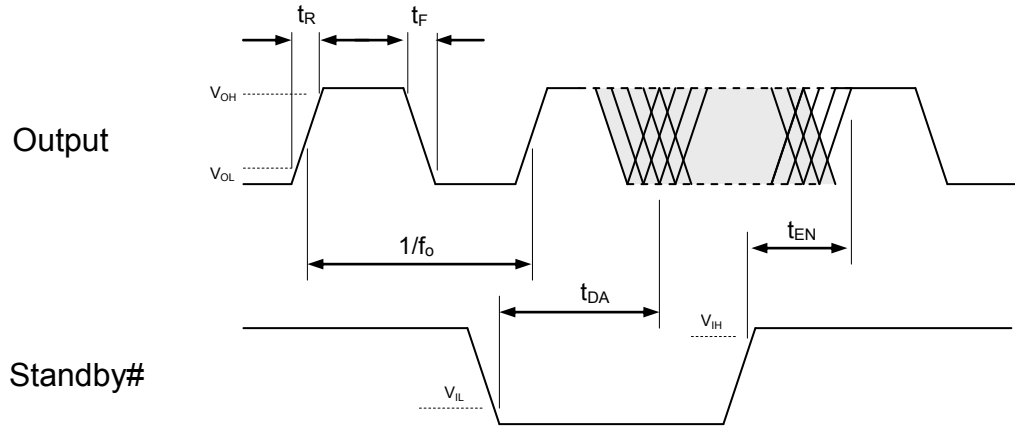

Standby Function

Standby# (pin 1)	Output (pin 3)
Hi Level	Output ON
Open (no connect)	Output ON
Low Level	High Impedance

Test Circuit



Board Layout (recommended)



Solder Reflow Profile



MSL 1 @ 260°C refer to JSTD-020C	
Ramp-Up Rate (200°C to Peak Temp)	3°C/Sec Max.
Preheat Time 150°C to 200°C	60-180 Sec
Time maintained above 217°C	60-150 Sec
Peak Temperature	255-260°C
Time within 5°C of actual Peak	20-40 Sec
Ramp-Down Rate	6°C/Sec Max.
Time 25°C to Peak Temperature	8 min Max.

Package Dimensions

7.0 x 5.0 mm Plastic Package

External Dimensions

Recommended Land Pattern*

No.	Pin Terminal
1	Standby#
2	GND
3	Output
4	VDD

*Note: The center pad is not connected internally and should be left unconnected or tied to GND.

units: mm [inch]

5.0 x 3.2 mm Plastic Package

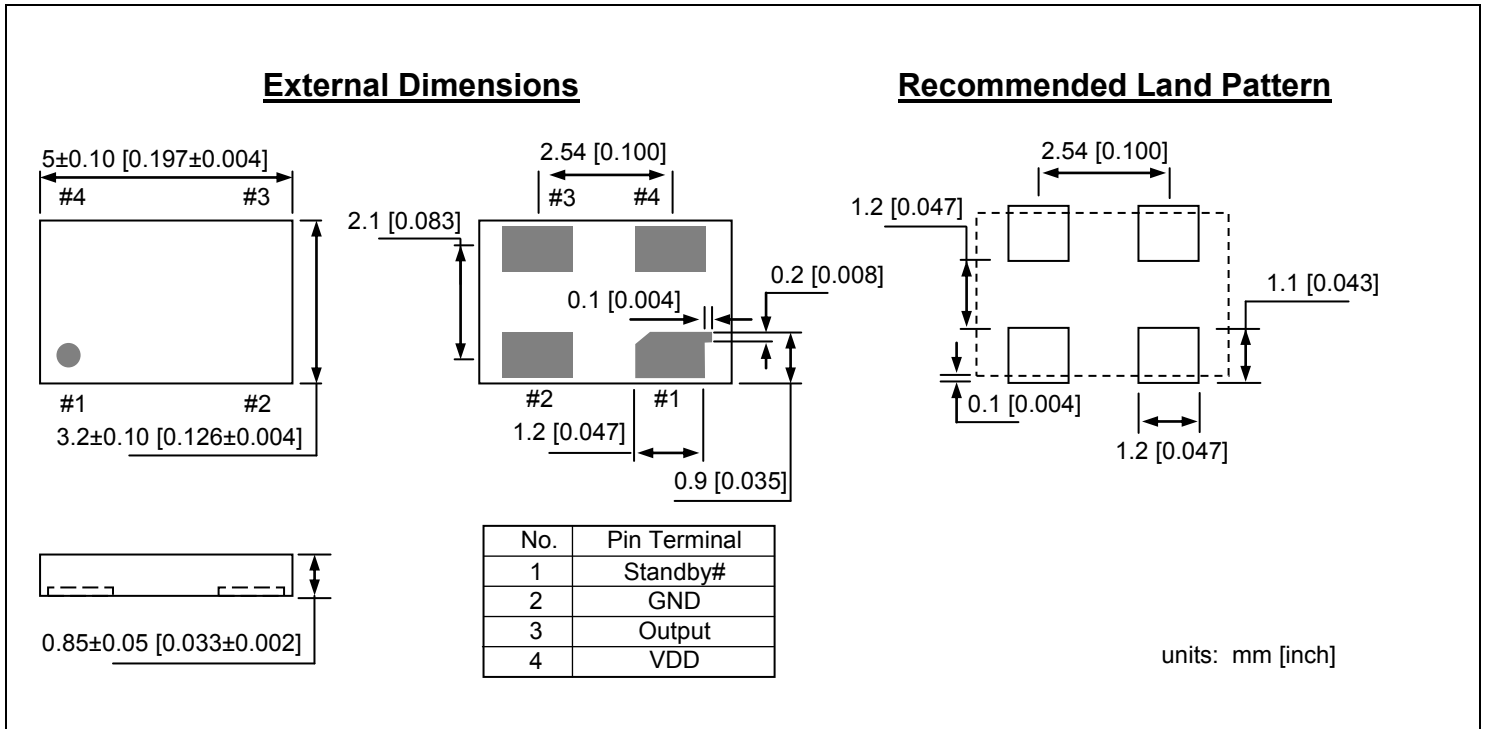

3.2 x 2.5 mm Plastic Package

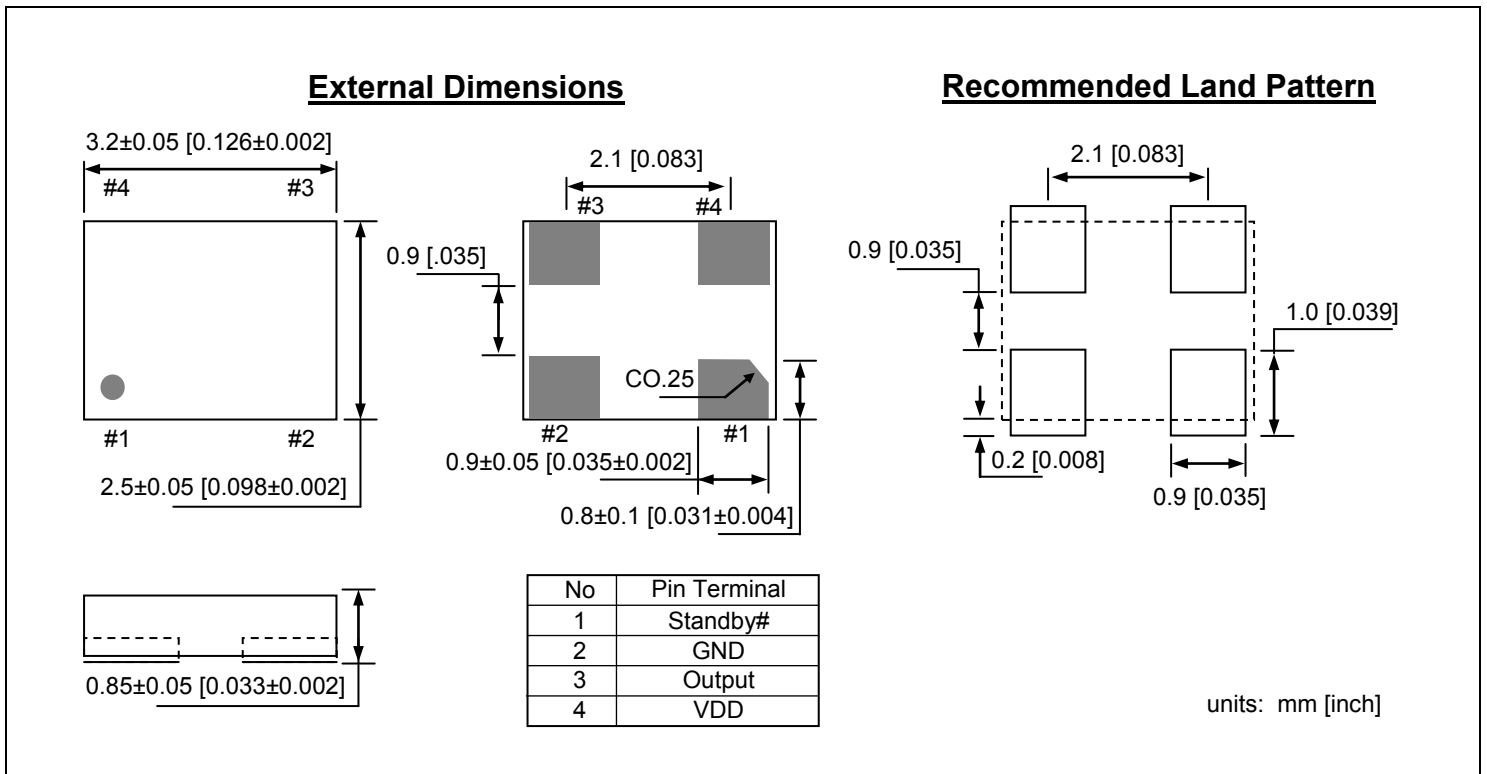

2.5 x 2.0 mm Plastic Package

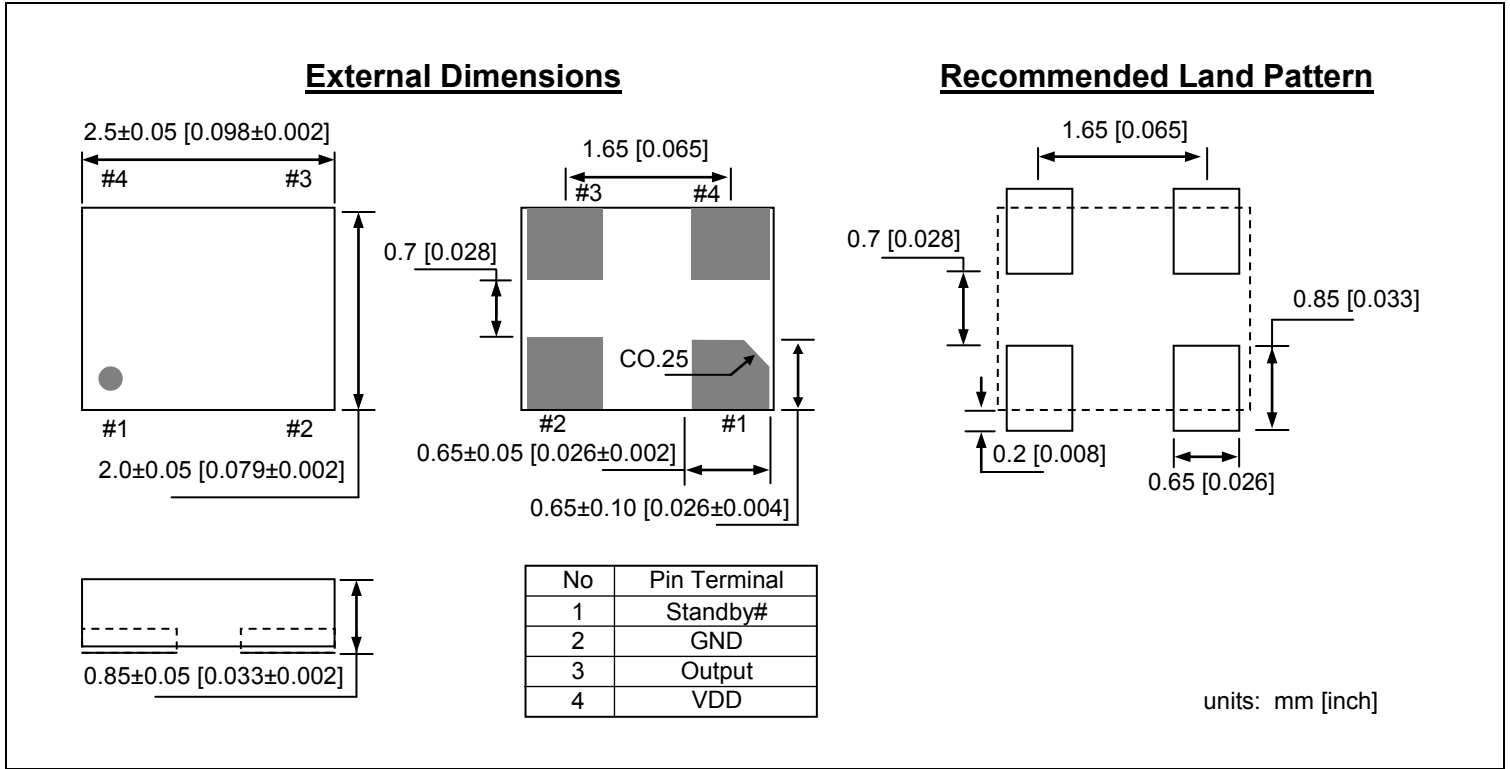

Ordering Information

DSC1030 PTS – xxx.xxxx T

PART NUMBERING GUIDE				
Package (Plastic QFN)	Temperature	Stability	Frequency	Packing Option
P=A: 7.0x5.0mm P=B: 5.0x3.2mm P=C: 3.2x2.5mm P=D: 2.5x2.0mm	T=C: 0° ~ +70° C T=E: -20° ~ +70° C T=I: -40° ~ +85° C	S=1: ±50ppm S=2: ±25ppm	XXX.XXXX (4 decimal places)	Blank: Tubes T: Tape & Reel

Example: DSC1030CE1-123.0000T

The example part number above is a 123.0000MHz oscillator in Plastic 3.2x2.5mm package, with ±50ppm stability over an operating temperature of -20 to +70°C, shipped in Tape and Reel. The reel size (7" or 13" diameter) will be determined by the factory based on quantity.

Disclaimer:

Micrel makes no representations or warranties with respect to the accuracy or completeness of the information furnished in this data sheet. This information is not intended as a warranty and Micrel does not assume responsibility for its use. Micrel reserves the right to change circuitry, specifications and descriptions at any time without notice. No license, whether express, implied, arising by estoppel or otherwise, to any intellectual property rights is granted by this document. Except as provided in Micrel's terms and conditions of sale for such products, Micrel assumes no liability whatsoever, and Micrel disclaims any express or implied warranty relating to the sale and/or use of Micrel products including liability or warranties relating to fitness for a particular purpose, merchantability, or infringement of any patent, copyright or other intellectual property right.

MICREL, Inc.
 Phone: +1 (408) 944-0800

• **2180 Fortune Drive,** **San Jose, California 95131** •
 • **Fax: +1 (408) 474-1000** • **Email: hbwhelp@micrel.com** •

USA
www.micrel.com

Looking for pricing, stock, or lifecycle information?

Click below to explore more details on WIN SOURCE:

- ⊖ [View DSC1030BC1-030.0000T on WIN SOURCE](#)
- ⊖ [Microchip Technology](#) Information

Optimize Your Supply Chain with WIN SOURCE Solutions

- ✓ Global Sourcing Solution
- ✓ Obsolete Management
- ✓ Cost Control Management
- ✓ Shortage Management
- ✓ Alternative Solution
- ✓ Excess Inventory Management