



**THE DATASHEET OF
DS1035Z-6**



FEATURES

- All-silicon timing circuit
- Three independent buffered delays
- Stable and precise over temperature and voltage
- Leading and trailing edge precision preserves the input symmetry
- Standard 8-pin DIP and 8-pin SOIC (150 mil)
- Vapor phasing, IR and wave solderable
- Available in Tape and Reel

PIN ASSIGNMENT

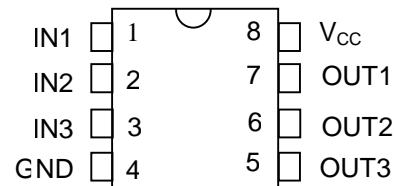

DS1035M 8-Pin DIP
See Mech. Drawings Section

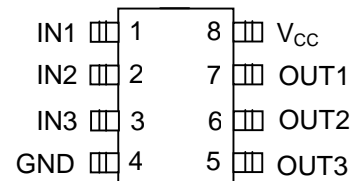

DS1035Z 8-Pin SOIC (150-mil)
See Mech. Drawings Section

PIN DESCRIPTION

IN1-IN3	- Input Signals
OUT1-OUT3	- Output Signals
NC	- No Connection
V _{CC}	- +5 Volt Supply
GND	- Ground
(Sub)	- Internal substrate connection, do not make any external connections to these pins

DESCRIPTION

The DS1035 series is a low-power +5-volt high-speed version of the popular DS1013 and complements the DS1033 +3.3 Volt version.

The DS1035 series of delay lines have three independent logic buffered delays in a single package. The device is Dallas Semiconductor's fastest 3-in-1 delay line. It is available in a standard 8-pin DIP and 150 Mil 8-pin Mini-SOIC.

The device features precise leading and trailing edge accuracies. It has the inherent reliability of an all-silicon delay line solution. The DS1035's initial tolerance is ± 1.5 or ± 2.0 ns with an additional tolerance over temperature and voltage of ± 1.0 ns or ± 1.5 ns, depending on the delay value. Each output is capable of driving up to 10 LS loads.

Standard delay values are indicated in Table 1. Customers may contact Dallas Semiconductor at (982) 371-4348 for further information.

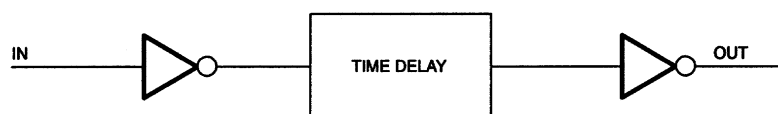
LOGIC DIAGRAM Figure 1

ONE OF THREE

PART NUMBER DELAY TABLE (t_{PLH} , t_{PHL}) Table 1

PART NUMBER	DELAY PER OUTPUT (ns)	INITIAL TOLERANCE	TOLERANCE OVER TEMPERATURE AND VOLTAGE
DS1035-6	6/6/6	±1.5 ns	±1.0 ns
DS1035-8	8/8/8	±1.5 ns	±1.0 ns
DS1035-10	10/10/10	±1.5 ns	±1.0 ns
DS1035-12	12/12/12	±1.5 ns	±1.0 ns
DS1035-15	15/15/15	±1.5 ns	±1.5 ns
DS1035-20	20/20/20	±1.5 ns	±1.5 ns
DS1035-25	25/25/25	±2.0 ns	±1.5 ns
DS1035-30	30/30/30	±2.0 ns	±1.5 ns

NOTES:

1. Nominal conditions are +25°C and $V_{CC}=+5.0$ volts.
2. Temperature range of 0°C to 70°C and voltage range of 4.75 volts to 5.25 volts.
3. Delay accuracy is for both leading and trailing edges.

TEST SETUP DESCRIPTION

Figure 2 illustrates the hardware configuration used for measuring the timing parameters of the DS1035. The input waveform is produced by a precision pulse generator under software control. Time delays are measured by a time interval counter (20 ps resolution) connected to the output. The DS1035 output taps are selected and connected to the interval counter by a VHF switch control unit. All measurements are fully automated with each instrument controlled by the computer over an IEEE 488 bus.

DS1035 TEST CIRCUIT Figure 2

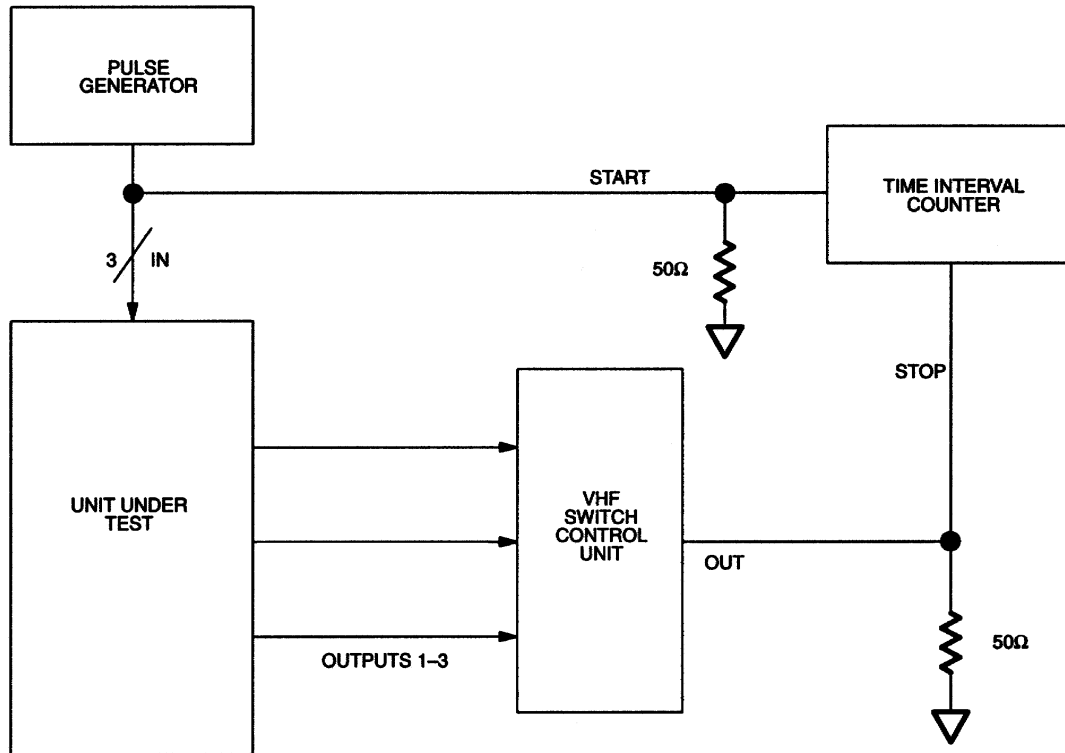

ABSOLUTE MAXIMUM RATINGS*

Voltage on Any Pin Relative to Ground	-1.0V to +7.0V
Operating Temperature	0°C to 70°C
Storage Temperature	-55°C to +125°C
Soldering Temperature	260°C for 10 seconds
Short Circuit Output Current	50 mA for 1 second

* This is a stress rating only and functional operation of the device at these or any other conditions above those indicated in the operation sections of this specification is not implied. Exposure to absolute maximum rating conditions for extended periods of time may affect reliability.

DC ELECTRICAL CHARACTERISTICS (0°C to 70°C; $V_{CC} = +5V \pm 5\%$)

PARAMETER	SYMBOL	TEST CONDITION	MIN	TYP	MAX	UNITS
Supply Voltage	V_{CC}		4.75	5.00	5.25	V
Active Current	I_{CC}	$V_{CC}=5.25V$ Period=1 μ s			35	mA
High Level Input Voltage	V_{IH}		2.2		$V_{CC} + 0.5$	V
Low Level Input Voltage	V_{IL}		-0.5		0.8	V
Input Leakage	I_L	$0V \leq V_I \leq V_{CC}$	-1.0		+1.0	μ A
High Level Output Current	I_{OH}	$V_{CC}=4.75V$ $V_{OH}=4V$			-1.0	mA
Low Level Output Current	I_{OL}	$V_{CC}=4.75V$ $V_{OL}=0.5V$	12			mA

AC ELECTRICAL CHARACTERISTICS (+25°C; $V_{CC} = 5V \pm 5\%$)

PARAMETER	SYMBOL	MIN	TYP	MAX	UNITS	NOTES
Period	t_{PERIOD}	2 (t_{WI})			ns	3
Input Pulse Width	t_{WI}	100% of Tap Delay			ns	3
Input-to-Tap Output Delay	t_{PLH} , t_{PHL}		Table 1		ns	
Output Rise or Fall Time	t_{OR} , t_{OF}		2.0	2.5	ns	
Power-up Time	t_{PU}			100	ms	

CAPACITANCE ($T_A = 25^\circ C$)

PARAMETER	SYMBOL	MIN	TYP	MAX	UNITS	NOTES
Input Capacitance	C_{IN}			10		pF

TEST CONDITIONS

Ambient Temperature: $25^{\circ}\text{C} \pm 3^{\circ}\text{C}$

Supply Voltage (V_{CC}): $5.0\text{V} \pm 0.1\text{V}$

Input Pulse:

High: $3.0\text{V} \pm 0.1\text{V}$

Low: $0.0\text{V} \pm 0.1\text{V}$

Source Impedance: 50Ω max.

Rise and Fall Time: 3.0 ns max. - Measured between 0.6V and 2.4V .

Pulse Width: 500 ns

Pulse Period: $1\ \mu\text{s}$

Output Load Capacitance: 15 pF

Output: Each output is loaded with the equivalent of one 74F04 input gate.
Data is measured at the 1.5V level on the rising and falling edges.

Note: The above conditions are for test only and do not restrict the devices under other data sheet conditions.

TIMING DIAGRAM

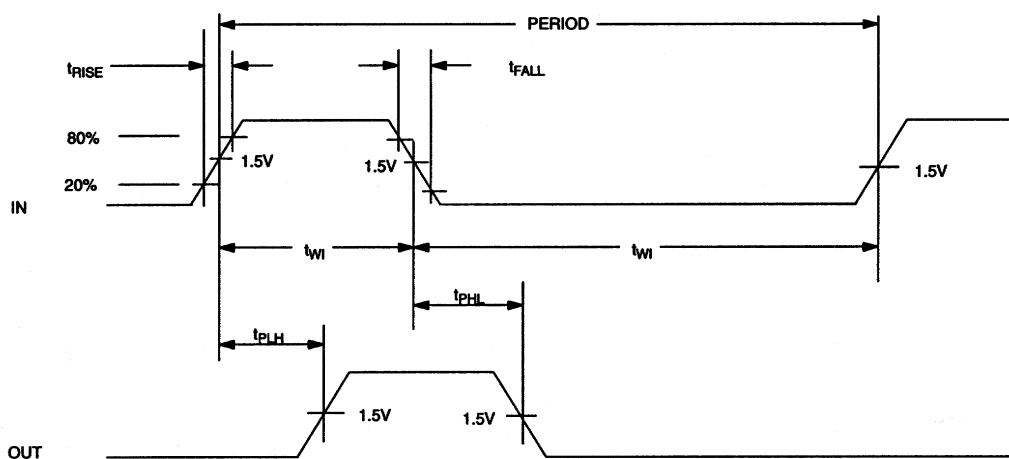

NOTES:

1. All voltages are referenced to ground.
2. @ $V_{\text{CC}}=5\text{ volts}$ and 25°C , delay accuracy on both the rising and falling edges within tolerances given in Table 1.
3. Pulse width and duty cycle specifications may be exceeded; however, accuracy will be application sensitive with respect to decoupling, layout, etc.

TERMINOLOGY

Period: The time elapsed between the leading edge of the first pulse and the leading edge of the following pulse.

t_{WI} (Pulse Width): The elapsed time on the pulse between the 1.5 volt point on the leading edge and the 1.5 volt point on the trailing edge, or the 1.5 volt point on the trailing edge and the 1.5 volt point on the leading edge.

t_{RISE} (Input Rise Time): The elapsed time between the 20% and the 80% point on the leading edge of the input pulse.

t_{FALL} (Input Fall Time): The elapsed time between the 80% and the 20% point on the trailing edge on the input pulse.

t_{PLH} (Time Delay, Rising): The elapsed time between the 1.5 volt point on the leading edge of the input pulse and the 1.5 volt point on the leading edge of the output pulse.

t_{PHL} (Time Delay, Falling): The elapsed time between the 1.5 volt point on the falling edge of the input pulse and the 1.5 volt point on the falling edge of the output pulse.

Looking for pricing, stock, or lifecycle information?

Click below to explore more details on WIN SOURCE:

 [View DS1035Z-6 on WIN SOURCE](#)

 [Maxim Integrated](#) Information

Optimize Your Supply Chain with WIN SOURCE Solutions

-  Global Sourcing Solution
-  Obsolete Management
-  Cost Control Management
-  Shortage Management
-  Alternative Solution
-  Excess Inventory Management