



**THE DATASHEET OF
DE2E3KY102MN2AM01F**



Lead Type Disc Ceramic Capacitors (Safety Standard Certified)

Resin Molding SMD Type Ceramic Capacitors (Safety Standard Certified)

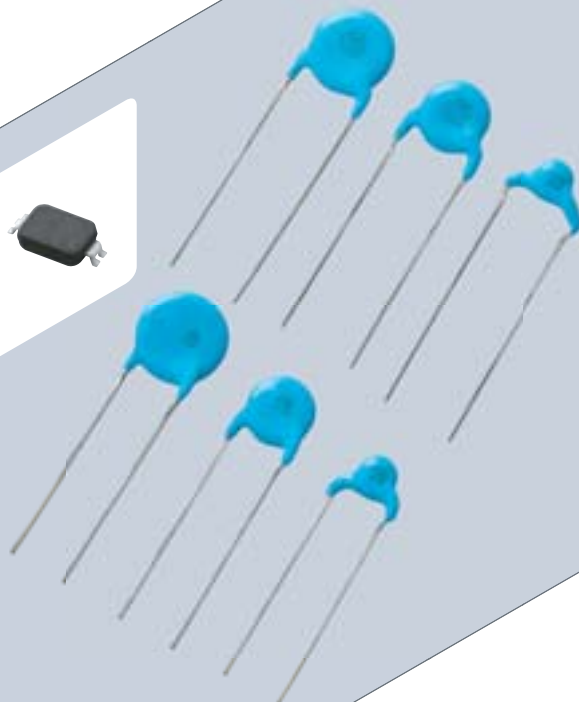



EU RoHS Compliant

- All the products in this catalog comply with EU RoHS.
- EU RoHS is "the European Directive 2011/65/EU on the Restriction of the Use of Certain Hazardous Substances in Electrical and Electronic Equipment."
- For more details, please refer to our web page, "Murata's Approach for EU RoHS" (<https://www.murata.com/en-eu/support/compliance/rohs>).

Contents

Product specifications are as of August 2018.

Part Numbering	p2
----------------------	----

Safety Standard Certified Resin Molding SMD Type Ceramic Capacitors for General Purpose

1 Type EA (Reinforced Insulation) -Class X1, Y1- (Recommend)	p5
Type EA Specifications and Test Methods	p7
Type EA Complement of Test Methods	p9
Type EA Packing	p10
Type EA ⚠Caution	p11
Type EA Notice	p14

Safety Standard Certified Lead Type Disc Ceramic Capacitors for General Purpose

2 Type SA: AC400V (Basic Insulation) -Class X1, Y2- (Recommend)	p15
3 Type RA: AC500V (Reinforced Insulation) -Class X1, Y1- (Recommend)	p17
Type SA: AC400V / RA: AC500V Specifications and Test Methods	p19
4 Type SA: AC250V or AC300V (Basic Insulation) -Class X1, Y2- (Recommend)	p23
5 Type RA: AC250V or AC300V (Reinforced Insulation) -Class X1, Y1- (Recommend)	p26
Type SA: AC250V or AC300V / RA: AC250V or AC300V Specifications and Test Methods	p29
6 Type RB (Reinforced Insulation) -Class X1, Y1- (Recommend)	p33
Type RB: X1: AC760V Specifications and Test Methods	p35
7 Type KY (Basic Insulation) -Class X1, Y2-	p39
8 Type KX New Small Size (Reinforced Insulation) -Class X1, Y1-	p42
Type KY/KX Specifications and Test Methods	p45

Characteristics Data (Typical Example)	p49
Packaging	p53
⚠Caution	p55
Notice	p58

Safety Standard Certified Lead Type Disc Ceramic Capacitors for Automotive

9 Type KJ -Class X1, Y2- (For Automotive Use/AC Line Filter of PHEV/EV Charger)	p59
Type KJ Specifications and Test Methods	p60
Characteristics Data (Typical Example)	p64
Packaging	p65
⚠Caution	p66
Notice	p69

Lead Type Disc Ceramic Capacitors (Safety Certified)/ Resin Molding SMD Type Ceramic Capacitors (Safety Certified) ISO9000 Certifications	p70
--	-----

Please check the MURATA website (<https://www.murata.com/>)
if you cannot find a part number in this catalog.



● Part Numbering

Safety Standard Certified Resin Molding SMD Type Ceramic Capacitors for General Purpose

(Part Number)

DK	1	E3	EA	102	M	86	R	AH01
①	②	③	④	⑤	⑥	⑦	⑧	⑨

① Product ID ② Series Category

Product ID	Code	Outline	Contents
DK	1	Safety Standard Certified	IEC60384-14 ClassX1, Y1

③ Temperature Characteristics

Code	Temperature Characteristics	Cap. Change or Temp. Coeff.	Temperature Range
B3	B	±10%	-25 to +85°C
E3	E	+20%, -55%	
1X	SL	+350 to -1000ppm/°C	+20 to +85°C

④ Rated Voltage/Safety Standard Certified Type

Code	Rated Voltage
EA	X1: AC440V (r.m.s.), Y1: AC250V (r.m.s.) or X1: AC440V (r.m.s.), Y1: AC300V (r.m.s.) (Safety Standard Certified Type EA)

⑤ Capacitance

Expressed by three figures. The unit is pico-farad (pF). The first and second figures are significant digits, and the third figure expresses the number of zeros that follow the two numbers.

⑥ Capacitance Tolerance

Code	Capacitance Tolerance
K	±10%
M	±20%

⑦ Case Size

Code	Dimensions
86	8.0 x 6.0mm

⑧ Packaging

Code	Packaging
R	ø330mm Embossed Taping

⑨ Individual Specification Code

Expressed by four figures.

Safety Standard Certified Lead Type Disc Ceramic Capacitors for General Purpose

(Part Number)

DE	2	E3	KY	102	M	N3	A		F
①	②	③	④	⑤	⑥	⑦	⑧	⑨	⑩

① Product ID ② Series Category

Product ID	Code	Outline	Contents
DE	1	Safety Standard Certified	IEC60384-14 Class X1, Y1
	2		IEC60384-14 Class X1, Y2

For Electrical Appliance and Material Safety Law of Japan, the first three digits (①Product ID and ②Series Category) express "Series Name."

For Safety Certified Capacitors, the first three digits express product code. The fourth figure expresses certified type shown in ④Safety Standard Certified Type column.

③ Temperature Characteristics

Code	Temperature Characteristics	Cap. Change or Temp. Coeff.	Temperature Range
B3	B	±10%	-25 to +85°C
E3	E	+20%, -55%	
F3	F	+30%, -80%	
1X	SL	+350 to -1000ppm/°C	+20 to +85°C

④ Rated Voltage/Safety Standard Certified Type

Code	Rated Voltage
RA	X1: AC440V (r.m.s.), Y1: AC250V (r.m.s.) or X1: AC440V (r.m.s.), Y1: AC300V (r.m.s.) or X1: AC500V (r.m.s.), Y1: AC500V (r.m.s.) (Safety Standard Certified Type RA)
RB	X1: AC760V (r.m.s.), Y1: AC500V (r.m.s.) (Safety Standard Certified Type RB)
KX	X1: AC440V (r.m.s.), Y1: AC250V (r.m.s.) or X1: AC440V (r.m.s.), Y1: AC300V (r.m.s.) (Safety Standard Certified Type KX)
SA	X1: AC300V (r.m.s.), Y2: AC250V (r.m.s.) or X1: AC300V (r.m.s.), Y2: AC300V (r.m.s.) or X1: AC440V (r.m.s.), Y2: AC400V (r.m.s.) (Safety Standard Certified Type SA)
KY	X1: AC250V (r.m.s.), Y2: AC250V (r.m.s.) or X1: AC250V (r.m.s.), Y2: AC300V (r.m.s.) (Safety Standard Certified Type KY)

⑤ Capacitance

Expressed by three figures. The unit is pico-farad (pF). The first and second figures are significant digits, and the third figure expresses the number of zeros that follow the two numbers.

⑥ Capacitance Tolerance

Code	Capacitance Tolerance
J	±5%
K	±10%
M	±20%

⑦ Lead Style

Code	Lead Style	Dimensions (mm)		
		Lead Spacing	Lead Diameter	Pitch of Components
A2	Vertical Crimp Long	5	ø0.6±0.05	—
A3		7.5		
A4		10		
B2/J2	Vertical Crimp Short	5	ø0.6±0.05	—
B3/J3		7.5		
B4/J4		10		
N2	Vertical Crimp Taping	5	ø0.6±0.05	12.7
N3		7.5		15
N4		10		25.4

⑧ Packaging

Code	Packaging
A	Ammo Pack Taping
B	Bulk

⑨ Individual Specification Code

For part number that cannot be identified without "Individual Specification," it is added at the end of part number, expressed by three-digit alphanumerics.

⑩ Halogen-free Compatible Product

Safety Standard Certified Lead Type Disc Ceramic Capacitors for Automotive

(Part Number)

DE	6	E3	KJ	102	M	N3	A	
①	②	③	④	⑤	⑥	⑦	⑧	⑨

① Product ID **② Series Category**

Product ID	Code	Outline	Contents
DE	6	Safety Standard Certified	IEC60384-14 Class X1, Y2

The first three digits express product code. The fourth figure expresses certified type shown in **④ Safety Standard Certified Type** column.

③ Temperature Characteristics

Code	Temperature Characteristics	Cap. Change or Temp. Coeff.	Temperature Range
B3	B	±10%	-25 to +85°C
E3	E	+20%, -55%	

④ Rated Voltage/Safety Standard Certified Type

Code	Rated Voltage
KJ	X1: AC440V (r.m.s.), Y2: AC300V (r.m.s.) (Safety Standard Certified Type KJ)

⑤ Capacitance

Expressed by three figures. The unit is pico-farad (pF). The first and second figures are significant digits, and the third figure expresses the number of zeros that follow the two numbers.

⑥ Capacitance Tolerance

Code	Capacitance Tolerance
K	±10%
M	±20%

⑦ Lead Style

Code	Lead Style	Dimensions (mm)		
		Lead Spacing	Lead Diameter	Pitch of Components
A3	Vertical Crimp Long	7.5	ø0.6±0.05	—
B3	Vertical Crimp Short			—
N3	Vertical Crimp Taping			15

⑧ Packaging

Code	Packaging
A	Ammo Pack Taping
B	Bulk

⑨ Individual Specification Code

For part number that cannot be identified without "Individual Specification," it is added at the end of part number, expressed by three-digit alphanumerics.

Safety Standard Certified Resin Molding SMD Type Ceramic Capacitors for General Purpose

Type EA (Reinforced Insulation) -Class X1, Y1 SMD Type- (Recommend)

Features

1. Small size and low height SMD
2. Operating temperature range guaranteed up to 125°C.
3. Dielectric strength: AC4000V
4. Class X1/Y1 capacitors certified by ENEC (SEMKO)/UL/CQC/KTC
5. Can be use with a component in appliances requiring reinforced insulation and double insulation based on UL1492, IEC60065 and IEC60950.
6. Coated with flame-retardant halogen-free* epoxy resin (conforming to UL94V-0 standard).
 * Cl=900ppm max., Br=900ppm max. and Cl+Br=1500ppm max.
7. Rated voltage: X1: AC440V(r.m.s.), Y1: AC250V(r.m.s.) or X1: AC440V(r.m.s.), Y1: AC300V(r.m.s.)

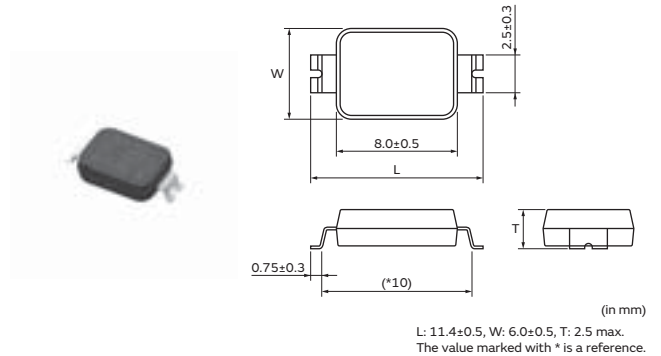

Applications

Ideal for use as Y capacitors and primary-secondary coupling on the reduction in the size and thickness of power supply equipment.

Do not use these products in any automotive power train or safety equipment including battery chargers for electric vehicles and plug-in hybrids. Only Murata products clearly stipulated as "for Automotive use" on its catalog can be used for automobile applications such as power train and safety equipment.

Standard Certification Rated Voltage (250Vac)

	Standard No.	Certified No.	Rated Voltage
ENEC (SEMKO)	EN 60384-14	SE/16008-1	250Vac(r.m.s.)
UL	UL 60384-14	E37921	
CQC	IEC 60384-14	CQC16001142384	
KTC	KC 60384-14	HU03008-16007	

* The certification number might change due to revision of the application standard and changes in the range of acquisition.

Marking Rated Voltage (250Vac)

Example	Item
	① Type Designation EA
	② Nominal Capacitance (Under 100pF: Actual value, 100pF and over: 3 digit system)
	③ Company Name Code Ⓒ15: Made in Thailand
	④ Manufactured Date Code KTC Approval Mark Class Code X1Y1 Rated Voltage Mark 440~, 250~

Continued on the following page. ↗

Continued from the preceding page. ↩

Standard Certification Rated Voltage (300Vac)

	Standard No.	Certified No.	Rated Voltage
ENEC (SEMKO)	EN 60384-14	SE/16008-1	300Vac(r.m.s.)
	UL	UL 60384-14	
CQC	IEC 60384-14	CQC16001142384	

• The certification number might change due to revision of the application standard and changes in the range of acquisition.

Marking Rated Voltage (300Vac)

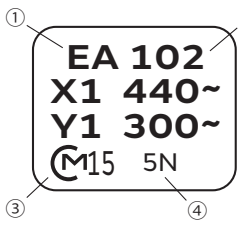
Example	Item
	① Type Designation EA
	② Nominal Capacitance (Under 100pF: Actual value, 100pF and over: 3 digit system)
	③ Company Name Code M15: Made in Thailand
	④ Manufactured Date Code
	Class Code X1Y1
	Rated Voltage Mark 440~, 300~

Rated Voltage 250Vac

Part Number	AC Rated Voltage	Temp. Char.	Capacitance	Dimension L	Dimension W	Body Thickness T
DK11XEA100K86RAH01	250Vac(r.m.s.)	SL	10pF±10%	11.4±0.5mm	6.0±0.5mm	2.5mm max.
DK11XEA220K86RAH01	250Vac(r.m.s.)	SL	22pF±10%	11.4±0.5mm	6.0±0.5mm	2.5mm max.
DK11XEA470K86RAH01	250Vac(r.m.s.)	SL	47pF±10%	11.4±0.5mm	6.0±0.5mm	2.5mm max.
DK1B3EA101K86RAH01	250Vac(r.m.s.)	B	100pF±10%	11.4±0.5mm	6.0±0.5mm	2.5mm max.
DK1B3EA221K86RAH01	250Vac(r.m.s.)	B	220pF±10%	11.4±0.5mm	6.0±0.5mm	2.5mm max.
DK1B3EA331K86RAH01	250Vac(r.m.s.)	B	330pF±10%	11.4±0.5mm	6.0±0.5mm	2.5mm max.
DK1B3EA471K86RAH01	250Vac(r.m.s.)	B	470pF±10%	11.4±0.5mm	6.0±0.5mm	2.5mm max.
DK1B3EA681K86RAH01	250Vac(r.m.s.)	B	680pF±10%	11.4±0.5mm	6.0±0.5mm	2.5mm max.
DK1E3EA102M86RAH01	250Vac(r.m.s.)	E	1000pF±20%	11.4±0.5mm	6.0±0.5mm	2.5mm max.
DK1E3EA152M86RAH01	250Vac(r.m.s.)	E	1500pF±20%	11.4±0.5mm	6.0±0.5mm	2.5mm max.

Murata part numbers might be changed. Therefore, please specify only the type name (EA) and capacitance of products in the part list when it is required for applying safety standard of electric equipments.

Rated Voltage 300Vac

Part Number	AC Rated Voltage	Temp. Char.	Capacitance	Dimension L	Dimension W	Body Thickness T
DK11XEA100K86RBH01	300Vac(r.m.s.)	SL	10pF±10%	11.4±0.5mm	6.0±0.5mm	2.5mm max.
DK11XEA220K86RBH01	300Vac(r.m.s.)	SL	22pF±10%	11.4±0.5mm	6.0±0.5mm	2.5mm max.
DK11XEA470K86RBH01	300Vac(r.m.s.)	SL	47pF±10%	11.4±0.5mm	6.0±0.5mm	2.5mm max.
DK1B3EA101K86RBH01	300Vac(r.m.s.)	B	100pF±10%	11.4±0.5mm	6.0±0.5mm	2.5mm max.
DK1B3EA221K86RBH01	300Vac(r.m.s.)	B	220pF±10%	11.4±0.5mm	6.0±0.5mm	2.5mm max.
DK1B3EA331K86RBH01	300Vac(r.m.s.)	B	330pF±10%	11.4±0.5mm	6.0±0.5mm	2.5mm max.
DK1B3EA471K86RBH01	300Vac(r.m.s.)	B	470pF±10%	11.4±0.5mm	6.0±0.5mm	2.5mm max.
DK1B3EA681K86RBH01	300Vac(r.m.s.)	B	680pF±10%	11.4±0.5mm	6.0±0.5mm	2.5mm max.
DK1E3EA102M86RBH01	300Vac(r.m.s.)	E	1000pF±20%	11.4±0.5mm	6.0±0.5mm	2.5mm max.
DK1E3EA152M86RBH01	300Vac(r.m.s.)	E	1500pF±20%	11.4±0.5mm	6.0±0.5mm	2.5mm max.

Murata part numbers might be changed. Therefore, please specify only the type name (EA) and capacitance of products in the part list when it is required for applying safety standard of electric equipments.

Type EA Specifications and Test Methods

1

Operating Temperature Range: -40 to +125°C

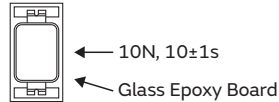
No.	Item	Specifications	Test Method																
1	Appearance	No defects or abnormalities	Visual Inspection.																
2	Dimensions	Within specified dimension	Using calipers and micrometers.																
3	Dielectric Strength	No defects or abnormalities	The capacitor shall not be damage when AC4000V(r.m.s.) is applied between the terminations for 60s.																
4	Insulation Resistance (I.R.)	6000MΩ or more	The insulation resistance shall be measured with DC500±50V within 60±5s of charging. The voltage should be applied to the capacitor through a resistor of 1MΩ.																
5	Capacitance	Within the specified tolerance	Capacitance/D.F. shall be measured at 20°C with the frequency of 1±0.2kHz and a voltage of AC1±0.2V(r.m.s.).																
6	Dissipation Factor (D.F.)	0.025 max.																	
7	Capacitance Temperature Characteristics	Temp. Coefficient SL: +350 to -1000 ppm/°C (Temp. Range: +20 to +85°C) Cap. Change B: within ±10% E: within ±20/-55% (Temp. Range: -25 to +85°C)	The capacitance measurement shall be made at each step in table. •Pretreatment for B, E char. Perform the heat treatment at 150+0/-10°C for 60±5min and then let sit for 24±2h at room condition*. <table border="1" style="margin-left: auto; margin-right: auto;"> <thead> <tr> <th>Step</th> <th>1</th> <th>2</th> <th>3</th> <th>4</th> <th>5</th> </tr> </thead> <tbody> <tr> <td>Temp. (°C)</td> <td>20±2</td> <td>-25±2</td> <td>20±2</td> <td>85±2</td> <td>20±2</td> </tr> </tbody> </table>	Step	1	2	3	4	5	Temp. (°C)	20±2	-25±2	20±2	85±2	20±2				
Step	1	2	3	4	5														
Temp. (°C)	20±2	-25±2	20±2	85±2	20±2														
8	Vibration Resistance	Appearance	No marked defect	Solder the capacitor to the Test Jig a (glass epoxy board) shown in "Complement of test method". The capacitor shall be subjected to a simple harmonic motion having a total amplitude of 1.5mm, the frequency being varied uniformly between the approximate limits of 10 and 55Hz. The frequency range, from 10 to 55Hz and return to 10Hz, shall be traversed in approximately 1min. This motion shall be applied for a period of 2h in each of 3 mutually perpendicular directions (total of 6h).															
		Capacitance	Within the specified tolerance																
		D.F.	Pass the item No.6																
9	Solderability of Termination	75% of the terminations are to be soldered.	Immerse the capacitor in the solution of ethanol (JIS K 8101) and rosin (JIS K 5902) (25% rosin in weight proportion). Immerse in solder solution for 2±0.5s. Temp. of solder: 245±5°C																
10	Soldering Effect (Reflow)	Appearance	No marked defects	Preheat the capacitor at 150 to 180°C for 90±30s. Reflow temp.: 230°C min. (max. temp.: 260°C) Reflow time: 30±10s. Reflow number of times: 4 times Let sit at room condition* for 24±2h, then measure. •The next reflow porcess should be done after the temperature of the sample has dropped to room temperature. •Pretreatment for B, E char. Capacitor should be stored at 150+0/-10°C for 1h, and apply the AC4000V(r.m.s.) 60s then placed at room condition* for 24±2h before initial measurements.															
		Capacitance	Within ±10%																
		I.R.	1000MΩ or more																
		Dielectric Strength	Pass the item No.3																
11	Adhesive strength of Termination	No removal of the terminations or other defects should occur.	Solder the capacitor to the Test Jig a (glass epoxy board) shown in "Complement of test method". Then apply 10N force in the direction of the arrow. 																
12	Temperature Cycle	Appearance	No marked defect	Fix the capacitor to the supporting Test Jig A (glass epoxy board) shown in "Complement of test method". Perform the 5 cycles according to the 4 heat treatments listed the following table. <table border="1" style="margin-left: auto; margin-right: auto;"> <thead> <tr> <th>Step</th> <th>Temp. (°C)</th> <th>Time (min.)</th> </tr> </thead> <tbody> <tr> <td>1</td> <td>-40±3</td> <td>30±3</td> </tr> <tr> <td>2</td> <td>Room Temp.</td> <td>2 to 3</td> </tr> <tr> <td>3</td> <td>125±3</td> <td>30±3</td> </tr> <tr> <td>4</td> <td>Room Temp.</td> <td>2 to 3</td> </tr> </tbody> </table> Let sit for 24±2h, at room condition*, then measure. •Pretreatment for B, E char. Capacitor should be stored at 150+0/-10°C for 1h, and apply the AC4000V(r.m.s.) 60s then placed at room condition* for 24±2h before initial measurements.	Step	Temp. (°C)	Time (min.)	1	-40±3	30±3	2	Room Temp.	2 to 3	3	125±3	30±3	4	Room Temp.	2 to 3
		Step	Temp. (°C)		Time (min.)														
		1	-40±3		30±3														
		2	Room Temp.		2 to 3														
		3	125±3		30±3														
4	Room Temp.	2 to 3																	
Capacitance Change	Within ±15%																		
D.F.	SL: 0.025 max. B, E: 0.05 max.																		
I.R.	3000MΩ or more																		
Dielectric Strength	Pass the item No.3																		

* "Room condition" Temperature: 15 to 35°C, Relative humidity: 45 to 75%, Atmosphere pressure: 86 to 106kPa

Continued on the following page. ↗

7

Type EA Specifications and Test Methods

1

Continued from the preceding page. ↘

No.	Item	Specifications	Test Method
13	Humidity (Steady state)	Appearance	No marked defect
		Capacitance Change	Within $\pm 20\%$
		D.F.	SL: 0.025 max. B, E: 0.05 max.
		I.R.	3000M Ω or more
		Dielectric Strength	Pass the item No.3
14	Humidity Loading	Appearance	No marked defect
		Capacitance Change	Within $\pm 20\%$
		D.F.	SL: 0.025 max. B, E: 0.05 max.
		I.R.	3000M Ω or more
		Dielectric Strength	Pass the item No.3
15	Life	Appearance	No marked defect
		Capacitance Change	Within $\pm 20\%$
		I.R.	3000M Ω or more
		Dielectric Strength	Pass the item No.3
16	Passive Flammability	The burning time should not exceeded the time 30s. The tissue paper should not ignite.	
		The capacitor under test shall be held in the flame in the position which best promotes burning. Each specimen shall only be exposed once to the flame. Time of exposure to flame: 30s. Length of flame: 12 ± 1 mm Gas burner : Length 35mm min. : Inside Dia. 0.5 ± 0.1 mm : Outside Dia. 0.9mm max. Gas : Butane gas Purity 95% min.	

* "Room condition" Temperature: 15 to 35°C, Relative humidity: 45 to 75%, Atmosphere pressure: 86 to 106kPa

Continued on the following page. ↗

Type EA Specifications and Test Methods

Continued from the preceding page. ↘

No.	Item	Specifications	Test Method
17	Active Flammability	The cheesecloth should not be on fire.	<p>The capacitor shall be individually wrapped in at least one but more than two complete layers of cheesecloth. The capacitor shall be subjected to 20 discharges. The interval between successive discharges should be 5s. The UAC shall be maintained for 2min after the last discharge.</p> <p> C1,2 : $1\mu\text{F}\pm 10\%$ C3 : $0.033\mu\text{F}\pm 5\%$ 10kV L1 to 4 : $1.5\text{mH}\pm 20\%$ 16A Rod core choke Ct : $3\mu\text{F}\pm 5\%$ 10kv R : $100\Omega\pm 2\%$ Cx : Capacitor specimens UAC : $U_R\pm 5\%$ F : Fuse, rated 16A UR : Rated Voltage Ut : Voltage impressed on the tank capacitor Ct </p>

Complement of Test Method

Test Jig

The test jig should be Jig A as described in “Specifications and Test Methods”.

The specimen should be soldered by the conditions as described below.

Soldering Method: Reflow soldering

Solder: Sn-3.0Ag-0.5Cu

Test Jig A

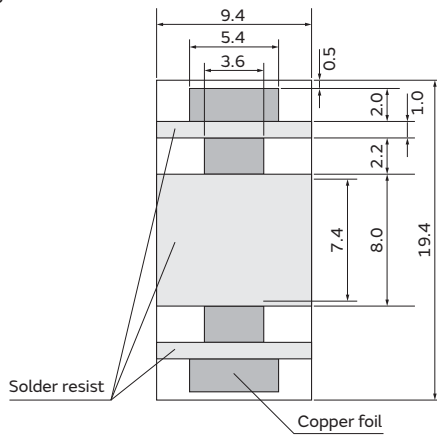

(in mm)

Test Jig

- Material: Glass Epoxy Board
- Thickness: 1.6mm
- Thickness of copper foil: 0.035mm

Type EA Packing

1

Packing

1. Dimension of Tape

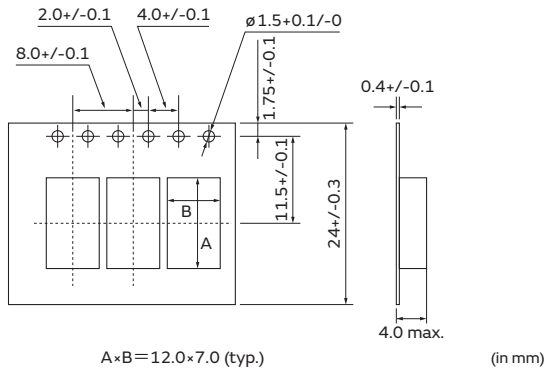

2. Dimension of Reel

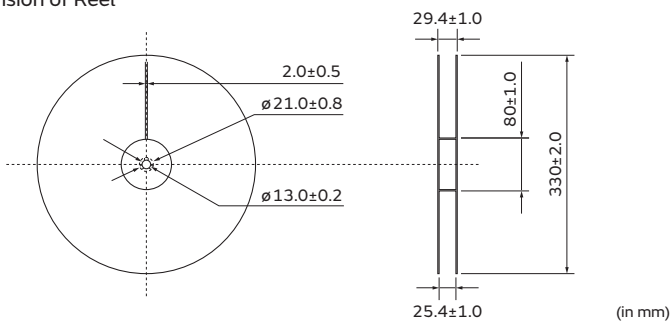

(1) Part of the leader and part of the empty tape shall be attached to the end of the tape as follows.

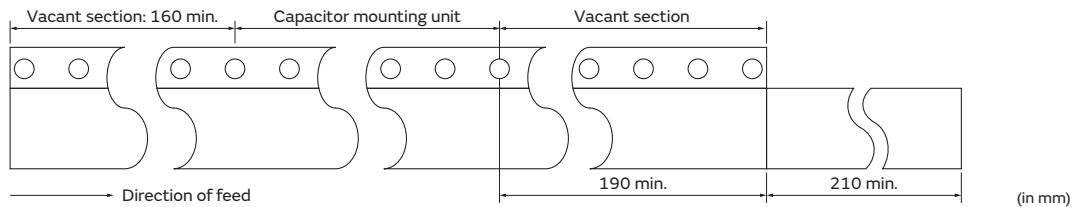

- (2) The top tape or cover tape and base tape are not attached at the end of the tape for a minimum of 2 pitches.
- (3) Missing capacitors number within 0.1% of the number per reel or 1pc, whichever is greater, and not continuous.
- (4) The top tape or cover tape and bottom tape shall not protrude beyond the edges of the tape and shall not cover sprocket holes.
- (5) Cumulative tolerance of sprocket holes, 10 pitches: $\pm 0.3\text{mm}$.
- (6) Peeling off force: 0.1 to 0.6N in the direction shown on the follows.

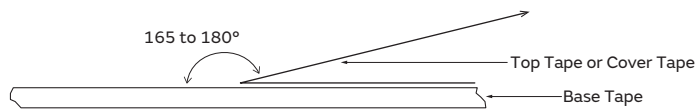

Minimum Quantity (Order in Sets Only)

[Taping]	(pcs./Ammo Pack)
	Packing Qty
Type EA	2,500

Type EA ⚠Caution

1

⚠Caution (Rating)

1. Operating Voltage

When DC-rated capacitors are to be used in AC or ripple current circuits, be sure to maintain the V_{p-p} value of the applied voltage or the V_{o-p} that contains DC bias within the rated voltage range.

When the voltage is applied to the circuit, starting or stopping may generate irregular voltage for a transit period because of resonance or switching. Be sure to use a capacitor with a rated voltage range that includes these irregular voltages.

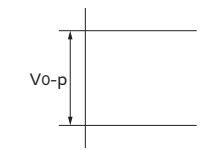
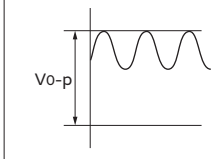
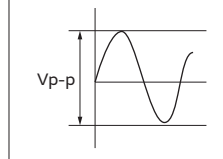
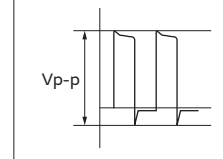
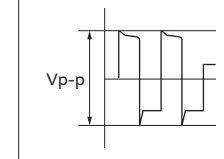
Voltage	DC Voltage	DC+AC Voltage	AC Voltage	Pulse Voltage (1)	Pulse Voltage (2)
Positional Measurement					

2. Operating Temperature and Self-generated Heat (Apply to B/E/F Char.)

Keep the surface temperature of a capacitor below the upper limit of its rated operating temperature range. Be sure to take into account the heat generated by the capacitor itself. When the capacitor is used in a high-frequency current, pulse current or similar current, it may have self-generated heat due to dielectric loss. Applied voltage load should be such that self-generated heat is within 20°C under the condition where the capacitor is subjected to an atmospheric temperature of 25°C. When measuring, use a thermocouple of small thermal capacity-K of $\phi 0.1\text{mm}$ under conditions where the capacitor is not affected by radiant heat from other components or wind from surroundings. Excessive heat may lead to deterioration of the capacitor's characteristics and reliability. (Never attempt to perform measurement with the cooling fan running. Otherwise, accurate measurement cannot be ensured.)

3. Test Condition for Withstanding Voltage

(1) Test Equipment

Test equipment for AC withstanding voltage should be used with the performance of the wave similar to 50/60Hz sine wave.

If the distorted sine wave or overload exceeding the specified voltage value is applied, a defect may be caused.

Continued on the following page. ↗

Type EA ⚠Caution

1

Continued from the preceding page. ↘

(2) Voltage Applied Method

When the withstanding voltage is applied, the capacitor's lead or terminal should be firmly connected to the output of the withstanding voltage test equipment, and then the voltage should be raised from near zero to the test voltage.

If the test voltage without the raise from near zero voltage would be applied directly to capacitor, test voltage should be applied with the zero cross.* At the end of the test time, the test voltage should be reduced to near zero, and then capacitor's lead or terminal should be taken off the output of the withstanding voltage test equipment.

If the test voltage without the raise from near zero voltage would be applied directly to capacitor, the surge voltage may rise, and therefore, a defect may be caused.

*ZERO CROSS is the point where voltage sine wave passes 0V. See the figure at right.

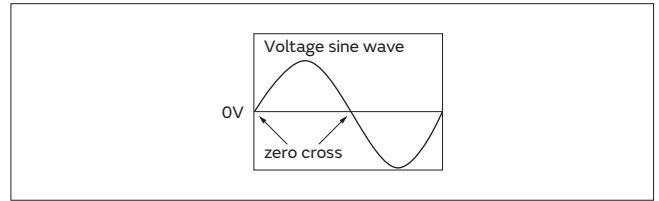

4. Fail-Safe

When the capacitor is broken, failure may result in a short circuit. Be sure to provide an appropriate fail-safe function like a fuse on your product if failure could result in an electric shock, fire or fuming.

FAILURE TO FOLLOW THE ABOVE CAUTIONS MAY RESULT, WORST CASE, IN A SHORT CIRCUIT AND CAUSE FUMING OR PARTIAL DISPERSION WHEN THE PRODUCT IS USED.

Type EA △Caution

1

△Caution (Storage and Operating Condition)

Operating and Storage Environment

The insulation coating of capacitors does not form a perfect seal; therefore, do not use or store capacitors in a corrosive atmosphere, especially where chloride gas, sulfide gas, acid, alkali, salt or the like are present. And avoid exposure to moisture. Before cleaning, bonding, or molding this product, verify that these processes do not affect product quality by testing the performance of a cleaned, bonded or molded product in the intended equipment.

This one is MSL 3 product. So, in order to avoid the absorption of moisture, capacitors are packed in moisture-proof envelope.

Store the capacitors in the following conditions at all times, and use within 6 months after delivered.

Temperature: 10 to 30°C.

Humidity: 60% max.

Solder the enclosed capacitors within 168 hours after opening the moisture-proof package.

After opening, store the capacitors in moisture-proof package with a desiccant and HIC card and keep the described condition.

In case the storage period has been exceeded 6 months or the indicator color of a enclosed HIC card has changed when the package has been opened, perform baking (60°C x 168h) before soldering.

FAILURE TO FOLLOW THE ABOVE CAUTIONS MAY RESULT, WORST CASE, IN A SHORT CIRCUIT AND CAUSE FUMING OR PARTIAL DISPERSION WHEN THE PRODUCT IS USED.

△Caution (Soldering and Mounting)

1. VIBRATION AND IMPACT

Do not expose a capacitor or its leads to excessive shock or vibration during use.

2. SOLDERING

(1) Reflow Soldering

When soldering capacitor, it should be performed in following conditions.

Soldering temperature: 230 to 260°C

Soldering time: 10 to 30s.

Preheating temperature: 170°C max.

(2) Flow Soldering

When soldering capacitor, it should be performed in following conditions.

Soldering temperature: 260°C max.

Soldering time: 5s max.

Preheating temperature: 120°C max.

Preheating time: 60s max.

(3) Soldering Iron

When soldering this product to a PCB/PWB, do not exceed the solder heat resistance specification of the capacitor. Subjecting this product to excessive heating could melt the internal junction solder and may result in thermal shocks that can crack the ceramic element.

When soldering capacitor with a soldering iron, it should be performed in following conditions.

Temperature of iron-tip: 400°C max.

Soldering iron wattage: 50W max.

Soldering time: 3.5s max.

3. BONDING, RESIN MOLDING AND COATING

Before bonding, molding or coating this product, verify that these processes do not affect the quality of capacitor

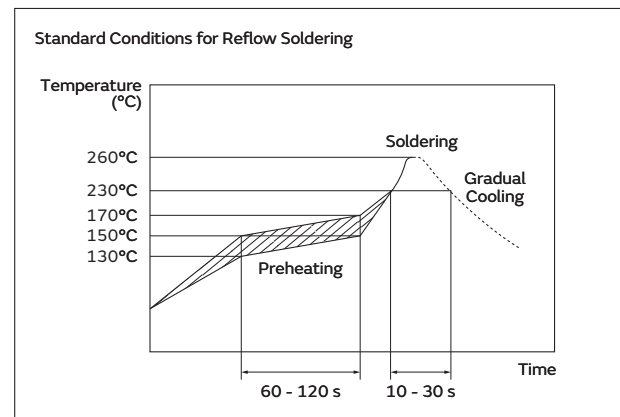

by testing the performance of the bonded, molded or coated product in the intended equipment. In case of the amount of applications, dryness / hardening conditions of adhesives and molding resins containing organic solvents (ethyl acetate, methyl ethyl ketone, toluene, etc.) are unsuitable, the outer coating resin of a capacitor is damaged by the organic solvents and it may result, worst case, in a short circuit.

The variation in thickness of adhesive, molding resin or coating may cause a outer coating resin cracking and/or ceramic element cracking of a capacitor in a temperature cycling.

FAILURE TO FOLLOW THE ABOVE CAUTIONS MAY RESULT, WORST CASE, IN A SHORT CIRCUIT AND CAUSE FUMING OR PARTIAL DISPERSION WHEN THE PRODUCT IS USED.

Type EA ⚠Caution/Notice

1

⚠Caution (Handling)

VIBRATION AND IMPACT

Do not expose a capacitor or its leads to excessive shock or vibration during use.

FAILURE TO FOLLOW THE ABOVE CAUTIONS MAY RESULT, WORST CASE, IN A SHORT CIRCUIT AND CAUSE FUMING OR PARTIAL DISPERSION WHEN THE PRODUCT IS USED.

Notice (Soldering and Mounting)

CLEANING (ULTRASONIC CLEANING)

To perform ultrasonic cleaning, observe the following conditions.

Rinse bath capacity: Output of 20 watts per liter or less.

Rinsing time: 5min maximum.

Do not vibrate the PCB/PWB directly.

Excessive ultrasonic cleaning may lead to fatigue destruction of the terminals.

Notice (Rating)

1. CAPACITANCE CHANGE OF CAPACITORS

(1) Class 1 capacitors

Capacitance might change a little depending on a surrounding temperature or an applied voltage.

Please contact us if you use for the strict time constant circuit.

(2) Class 2 capacitors

Class 2 capacitors like temperature characteristic B, E and F have an aging characteristic, whereby the capacitor continually decreases its capacitance slightly if the capacitor leaves for a long time.

Moreover, capacitance might change greatly depending on a surrounding temperature or an applied voltage.

So, it is not likely to be able to use for the time constant circuit.

Please contact us if you need a detail information.

2. PERFORMANCE CHECK BY EQUIPMENT

Before using a capacitor, check that there is no problem in the equipment's performance and the specifications.

Generally speaking, Class 2 ceramic capacitors have voltage dependence characteristics and temperature dependence characteristics in capacitance.

So, the capacitance value may change depending on the operating condition in a equipment.

Therefore, be sure to confirm the apparatus performance of receiving influence in a capacitance value change of a capacitor, such as leakage current and noise suppression characteristic.

Moreover, check the surge-proof ability of a capacitor in the equipment, if needed, because the surge voltage may exceed specific value by the inductance of the circuit.

Safety Standard Certified Lead Type Disc Ceramic Capacitors for General Purpose

Type SA: AC400V (Basic Insulation) -Class X1, Y2- (Recommend)

Features

1. Impulse voltage guaranteed 8kV_{0-p}.
2. Operating temperature range guaranteed up to 125°C.
3. Dielectric strength: AC2600V
4. Class X1/Y2 capacitors certified by ENEC(VDE)/UL/CQC.
5. Coated with flame-retardant halogen-free* epoxy resin (conforming to UL94V-0 standard).
 * Cl=900ppm max., Br=900ppm max. and Cl+Br=1500ppm max.
6. Taping available for automatic insertion.
7. Rated Voltage: X1: AC440V(r.m.s.), Y2: AC400V(r.m.s.)

Applications

Ideal for use as X/Y capacitors for AC line filters and primary-secondary coupling on switching power supplies and AC adapters.

Do not use these products in any automotive power train or safety equipment including battery chargers for electric vehicles and plug-in hybrids. Only Murata products clearly stipulated as "for Automotive use" on its catalog can be used for automobile applications such as power train and safety equipment.

Standard Certification

	Standard No.	Certified No.	Rated Voltage
ENEC (VDE)	EN 60384-14	40042990	400Vac(r.m.s.)
UL	UL 60384-14	E37921	
CQC	IEC 60384-14	CQC15001137840	

* The certification number might change due to revision of the application standard and changes in the range of acquisition.

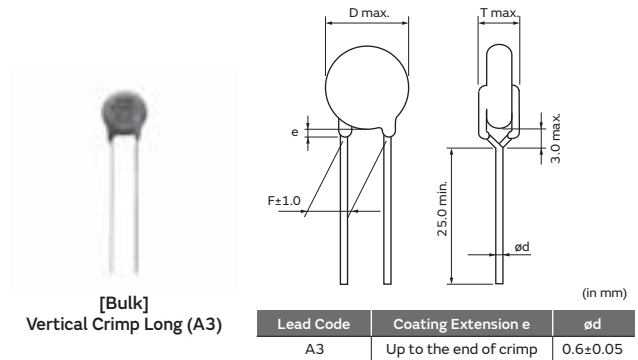

[Bulk]
 Vertical Crimp Long (A3)

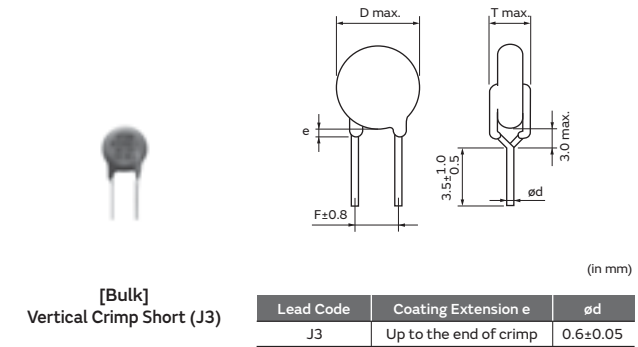

[Bulk]
 Vertical Crimp Short (J3)

Marking

Example	Item
	① Type Designation SA
	② Nominal Capacitance (Under 100pF: Actual value, 100pF and over: 3 digit system)
	③ Capacitance Tolerance
	④ Company Name Code Ⓒ15: Made in Thailand
	⑤ Manufactured Date Code Class Code X1Y2 Rated Voltage Mark 440~, 400~

Rated Voltage 400Vac

Part Number	AC Rated Voltage	Temp. Char.	Capacitance	Body Dia. D	Lead Spacing F (mm)	Body Thickness T	Lead Package Long Bulk	Lead Package Short Bulk	Lead Package Taping
DE21XSA100K□□□Y02F	400Vac(r.m.s.)	SL	10pF±10%	7.0mm max.	7.5	5.0mm max.	A3B	J3B	N3A
DE21XSA150K□□□Y02F	400Vac(r.m.s.)	SL	15pF±10%	6.0mm max.	7.5	6.0mm max.	A3B	J3B	N3A
DE21XSA220K□□□Y02F	400Vac(r.m.s.)	SL	22pF±10%	6.0mm max.	7.5	5.0mm max.	A3B	J3B	N3A
DE21XSA330K□□□Y02F	400Vac(r.m.s.)	SL	33pF±10%	7.0mm max.	7.5	5.0mm max.	A3B	J3B	N3A
DE21XSA470K□□□Y02F	400Vac(r.m.s.)	SL	47pF±10%	7.0mm max.	7.5	5.0mm max.	A3B	J3B	N3A
DE21XSA680K□□□Y02F	400Vac(r.m.s.)	SL	68pF±10%	9.0mm max.	7.5	5.0mm max.	A3B	J3B	N3A
DE2B3SA101K□□□Y02F	400Vac(r.m.s.)	B	100pF±10%	6.0mm max.	7.5	5.0mm max.	A3B	J3B	N3A
DE2B3SA151K□□□Y02F	400Vac(r.m.s.)	B	150pF±10%	6.0mm max.	7.5	5.0mm max.	A3B	J3B	N3A
DE2B3SA221K□□□Y02F	400Vac(r.m.s.)	B	220pF±10%	6.0mm max.	7.5	6.0mm max.	A3B	J3B	N3A
DE2B3SA331K□□□Y02F	400Vac(r.m.s.)	B	330pF±10%	6.0mm max.	7.5	5.0mm max.	A3B	J3B	N3A
DE2B3SA471K□□□Y02F	400Vac(r.m.s.)	B	470pF±10%	7.0mm max.	7.5	5.0mm max.	A3B	J3B	N3A
DE2B3SA681K□□□Y02F	400Vac(r.m.s.)	B	680pF±10%	8.0mm max.	7.5	5.0mm max.	A3B	J3B	N3A
DE2E3SA102M□□□Y02F	400Vac(r.m.s.)	E	1000pF±20%	7.0mm max.	7.5	5.0mm max.	A3B	J3B	N3A
DE2E3SA152M□□□Y02F	400Vac(r.m.s.)	E	1500pF±20%	8.0mm max.	7.5	5.0mm max.	A3B	J3B	N3A
DE2E3SA222M□□□Y02F	400Vac(r.m.s.)	E	2200pF±20%	9.0mm max.	7.5	5.0mm max.	A3B	J3B	N3A
DE2E3SA332M□□□Y02F	400Vac(r.m.s.)	E	3300pF±20%	12.0mm max.	7.5	5.0mm max.	A3B	J3B	N3A
DE2E3SA472M□□□Y02F	400Vac(r.m.s.)	E	4700pF±20%	13.0mm max.	7.5	5.0mm max.	A3B	J3B	N3A
DE2E3SA103M□□□Y02F	400Vac(r.m.s.)	E	10000pF±20%	17.0mm max.	7.5	6.0mm max.	A3B	J3B	N7A

Three blank columns are filled with the lead and packaging codes. Please refer to the 3 columns on the right for the appropriate codes.

Individual specification code "Y02F" express "simplicity marking and guarantee of dielectric strength between lead wires: AC2600V."

Murata part numbers might be changed depending on lead code or any other changes. Therefore, please specify only the type name (SA) and capacitance of products in the part list when it is required for applying safety standard of electric equipments.

Safety Standard Certified Lead Type Disc Ceramic Capacitors for General Purpose

Type RA: AC500V (Reinforced Insulation) -Class X1, Y1- (Recommend)

Features

1. Impulse voltage guaranteed 12kV_{0-p}.
2. Operating temperature range guaranteed up to 125°C.
3. Dielectric strength: AC4000V
4. Class X1/Y1 capacitors certified by ENEC(VDE)/UL/CQC.
5. Can be use with a component in appliances requiring reinforced insulation and double insulation based on UL1492, IEC60065 and IEC60950.
6. Coated with flame-retardant halogen-free* epoxy resin (conforming to UL94V-0 standard).
 * Cl=900ppm max., Br=900ppm max. and Cl+Br=1500ppm max.
7. Taping available for automatic insertion.
8. Rated Voltage: X1: AC500V(r.m.s.), Y1: AC500V(r.m.s.)

Applications

Ideal for use as X/Y capacitors for AC line filters and primary-secondary coupling on switching power supplies and AC adapters.

Do not use these products in any automotive power train or safety equipment including battery chargers for electric vehicles and plug-in hybrids. Only Murata products clearly stipulated as "for Automotive use" on its catalog can be used for automobile applications such as power train and safety equipment.

Standard Certification

	Standard No.	Certified No.	Rated Voltage
ENEC (VDE)	EN 60384-14	40043033	500Vac(r.m.s.)
UL	UL 60384-14	E37921	
CQC	IEC 60384-14	CQC16001138225	

• The certification number might change due to revision of the application standard and changes in the range of acquisition.

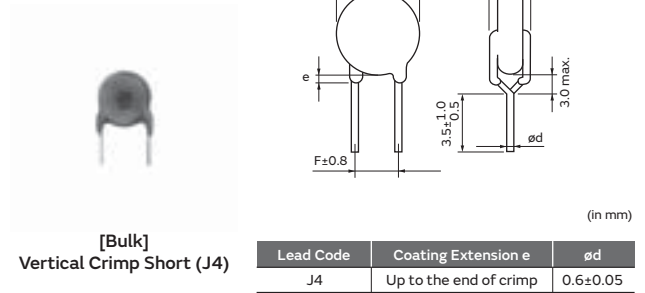
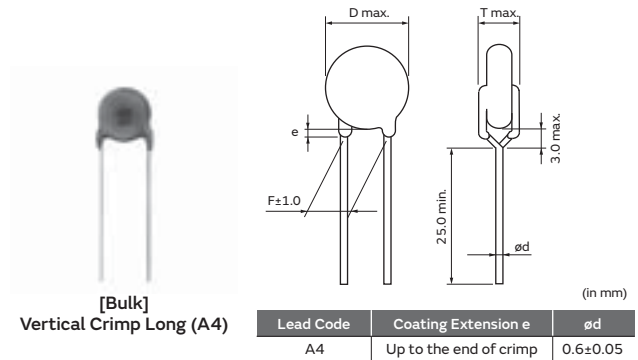

Marking

Example	Item
	① Type Designation RA
	② Nominal Capacitance (Under 100pF: Actual value, 100pF and over: 3 digit system)
	③ Capacitance Tolerance
	④ Company Name Code ©15: Made in Thailand
	⑤ Manufactured Date Code Class Code X1Y1 Rated Voltage Mark 500~

Rated Voltage 500Vac

Part Number	AC Rated Voltage	Temp. Char.	Capacitance	Body Dia. D	Lead Spacing F (mm)	Body Thickness T	Lead Package Long Bulk	Lead Package Short Bulk	Lead Package Taping
DE11XRA100K□□□Q01F	500Vac(r.m.s.)	SL	10pF±10%	8.0mm max.	10.0	5.0mm max.	A4B	J4B	N4A
DE11XRA150K□□□Q01F	500Vac(r.m.s.)	SL	15pF±10%	6.0mm max.	10.0	6.0mm max.	A4B	J4B	N4A
DE11XRA220K□□□Q01F	500Vac(r.m.s.)	SL	22pF±10%	6.0mm max.	10.0	5.0mm max.	A4B	J4B	N4A
DE11XRA330K□□□Q01F	500Vac(r.m.s.)	SL	33pF±10%	7.0mm max.	10.0	5.0mm max.	A4B	J4B	N4A
DE11XRA470K□□□Q01F	500Vac(r.m.s.)	SL	47pF±10%	8.0mm max.	10.0	5.0mm max.	A4B	J4B	N4A
DE11XRA680K□□□Q01F	500Vac(r.m.s.)	SL	68pF±10%	9.0mm max.	10.0	5.0mm max.	A4B	J4B	N4A
DE1B3RA101K□□□Q01F	500Vac(r.m.s.)	B	100pF±10%	6.0mm max.	10.0	5.0mm max.	A4B	J4B	N4A
DE1B3RA151K□□□Q01F	500Vac(r.m.s.)	B	150pF±10%	8.0mm max.	10.0	5.0mm max.	A4B	J4B	N4A
DE1B3RA221K□□□Q01F	500Vac(r.m.s.)	B	220pF±10%	6.0mm max.	10.0	6.0mm max.	A4B	J4B	N4A
DE1B3RA331K□□□Q01F	500Vac(r.m.s.)	B	330pF±10%	7.0mm max.	10.0	6.0mm max.	A4B	J4B	N4A
DE1B3RA471K□□□Q01F	500Vac(r.m.s.)	B	470pF±10%	8.0mm max.	10.0	6.0mm max.	A4B	J4B	N4A
DE1B3RA681K□□□Q01F	500Vac(r.m.s.)	B	680pF±10%	9.0mm max.	10.0	6.0mm max.	A4B	J4B	N4A
DE1E3RA102M□□□Q01F	500Vac(r.m.s.)	E	1000pF±20%	8.0mm max.	10.0	6.0mm max.	A4B	J4B	N4A
DE1E3RA152M□□□Q01F	500Vac(r.m.s.)	E	1500pF±20%	9.0mm max.	10.0	6.0mm max.	A4B	J4B	N4A
DE1E3RA222M□□□Q01F	500Vac(r.m.s.)	E	2200pF±20%	11.0mm max.	10.0	6.0mm max.	A4B	J4B	N4A
DE1E3RA332M□□□Q01F	500Vac(r.m.s.)	E	3300pF±20%	13.0mm max.	10.0	6.0mm max.	A4B	J4B	N4A
DE1E3RA472M□□□Q01F	500Vac(r.m.s.)	E	4700pF±20%	14.0mm max.	10.0	6.0mm max.	A4B	J4B	N4A

Three blank columns are filled with the lead and packaging codes. Please refer to the 3 columns on the right for the appropriate codes.

Murata part numbers might be changed depending on lead code or any other changes. Therefore, please specify only the type name (RA) and capacitance of products in the part list when it is required for applying safety standard of electric equipments.

3

Type SA: AC400V / RA: AC500V Specifications and Test Methods

Operating Temperature Range: -40 to +125°C

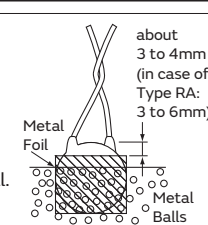
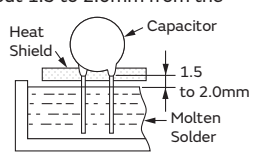
No.	Item	Specifications	Test Method																						
1	Appearance and Dimensions	No visible defect, and dimensions are within specified range.	The capacitor should be visually inspected for evidence of defect. Dimensions should be measured with slide calipers.																						
2	Marking	To be easily legible	The capacitor should be visually inspected.																						
3	Capacitance	Within specified tolerance	The capacitance, dissipation factor should be measured at 20°C with 1±0.1kHz and AC1±0.2V max.																						
4	Dissipation Factor (D.F.)	2.5% max.																							
5	Insulation Resistance (I.R.)	10000MΩ min.	The insulation resistance should be measured with DC500±50V within 60±5s of charging. The voltage should be applied to the capacitor through a resistor of 1MΩ.																						
6	Between Lead Wires	No failure	The capacitor should not be damaged when the test voltages from Table 1 are applied between the lead wires for 60s. <div style="text-align: center;"> <table border="1" style="margin: auto;"> <thead> <tr style="background-color: #444; color: white;"> <th>Type</th> <th>Test Voltage</th> </tr> </thead> <tbody> <tr> <td>SA</td> <td>AC2600V(r.m.s.) <50/60Hz></td> </tr> <tr> <td>RA</td> <td>AC4000V(r.m.s.) <50/60Hz></td> </tr> </tbody> </table> </div> First, the terminals of the capacitor should be connected together. Then, as shown in the figure at right, a metal foil should be closely wrapped around the body of the capacitor to the distance of about 3 to 4mm (in case of Type RA: 3 to 6mm) from each terminal. Then, the capacitor should be inserted into a container filled with metal balls of about 1mm diameter. Finally, AC voltage from Table 2 is applied for 60s between the capacitor lead wires and metal balls. <div style="text-align: right; margin-top: 10px;">  <p style="font-size: small;">about 3 to 4mm (in case of Type RA: 3 to 6mm)</p> </div> <div style="text-align: center;"> <table border="1" style="margin: auto;"> <thead> <tr style="background-color: #444; color: white;"> <th>Type</th> <th>Test Voltage</th> </tr> </thead> <tbody> <tr> <td>SA</td> <td>AC2600V(r.m.s.) <50/60Hz></td> </tr> <tr> <td>RA</td> <td>AC4000V(r.m.s.) <50/60Hz></td> </tr> </tbody> </table> </div>	Type	Test Voltage	SA	AC2600V(r.m.s.) <50/60Hz>	RA	AC4000V(r.m.s.) <50/60Hz>	Type	Test Voltage	SA	AC2600V(r.m.s.) <50/60Hz>	RA	AC4000V(r.m.s.) <50/60Hz>										
	Type	Test Voltage																							
SA	AC2600V(r.m.s.) <50/60Hz>																								
RA	AC4000V(r.m.s.) <50/60Hz>																								
Type	Test Voltage																								
SA	AC2600V(r.m.s.) <50/60Hz>																								
RA	AC4000V(r.m.s.) <50/60Hz>																								
Body Insulation	No failure																								
7	Temperature Characteristics	<table border="1" style="margin: auto; border-collapse: collapse;"> <thead> <tr style="background-color: #444; color: white;"> <th>Char.</th> <th>Capacitance Change</th> </tr> </thead> <tbody> <tr> <td>B</td> <td>Within ±10%</td> </tr> <tr> <td>E</td> <td>Within $\pm\frac{20}{55}\%$</td> </tr> </tbody> </table> (Temp. range: -25 to +85°C) <table border="1" style="margin: auto; border-collapse: collapse;"> <thead> <tr style="background-color: #444; color: white;"> <th>Char.</th> <th>Temperature Coefficient</th> </tr> </thead> <tbody> <tr> <td>SL</td> <td>+350 to -1000ppm/°C</td> </tr> </tbody> </table> (Temp. range: +20 to +85°C)	Char.	Capacitance Change	B	Within ±10%	E	Within $\pm\frac{20}{55}\%$	Char.	Temperature Coefficient	SL	+350 to -1000ppm/°C	The capacitance measurement should be made at each step specified in Table 3. <div style="text-align: center;"> <table border="1" style="margin: auto;"> <thead> <tr style="background-color: #444; color: white;"> <th>Step</th> <th>Temperature (°C)</th> </tr> </thead> <tbody> <tr><td>1</td><td>20±2</td></tr> <tr><td>2</td><td>-25±2</td></tr> <tr><td>3</td><td>20±2</td></tr> <tr><td>4</td><td>85±2</td></tr> <tr><td>5</td><td>20±2</td></tr> </tbody> </table> </div>	Step	Temperature (°C)	1	20±2	2	-25±2	3	20±2	4	85±2	5	20±2
Char.	Capacitance Change																								
B	Within ±10%																								
E	Within $\pm\frac{20}{55}\%$																								
Char.	Temperature Coefficient																								
SL	+350 to -1000ppm/°C																								
Step	Temperature (°C)																								
1	20±2																								
2	-25±2																								
3	20±2																								
4	85±2																								
5	20±2																								
8	Solderability of Leads	Lead wire should be soldered with uniform coating on the axial direction over 3/4 of the circumferential direction.	The lead wire of a capacitor should be dipped into molten solder for 2±0.5s. The depth of immersion is up to about 1.5 to 2.0mm from the root of lead wires. Temp. of solder: Lead Free Solder (Sn-3Ag-0.5Cu) 245±5°C																						
9	Appearance	No marked defect	Solder Temperature : 350±10°C or 260±5°C Immersion time : 3.5±0.5s (In case of 260±5°C : 10±1s) The depth of immersion is up to about 1.5 to 2.0mm from the roof of lead wires. <div style="text-align: right; margin-top: 10px;">  </div> Pre-treatment: Capacitor should be stored at 125±2°C for 1h, and apply the AC2000V(r.m.s.) 60s (in case of Type RA, apply the AC4000V(r.m.s.) 60s) then placed at room condition* for 24±2h before initial measurements. (Do not apply to SL char.) Post-treatment: Capacitor should be stored for 1 to 2h at room condition*.																						
	Capacitance Change	Within ±10%																							
	I.R.	1000MΩ min.																							
	Soldering Effect (Non-Preheat)	Dielectric Strength		Per Item 6																					

* "Room condition" Temperature: 15 to 35°C, Relative humidity: 45 to 75%, Atmosphere pressure: 86 to 106kPa

Continued on the following page. ↗

Type SA: AC400V / RA: AC500V Specifications and Test Methods

Continued from the preceding page. ↘

No.	Item	Specifications	Test Method								
10	Soldering Effect (On-Preheat)	Appearance	No marked defect								
		Capacitance Change	Within $\pm 10\%$								
		I.R.	1000M Ω min.								
		Dielectric Strength	Per Item 6								
<p>First the capacitor should be stored at 120+0/-5°C for 60+0/-5s. Then, as in the figure, the lead wires should be immersed in solder of 260+0/-5°C up to 1.5 to 2.0mm from the root of terminal for 7.5+0/-1s.</p> <p>Pre-treatment: Capacitor should be stored at 125\pm2°C for 1h, and apply the AC2000V(r.m.s.) 60s (in case of Type RA, apply the AC4000V(r.m.s.) 60s) then placed at room condition* for 24\pm2h before initial measurements. (Do not apply to SL char.)</p> <p>Post-treatment: Capacitor should be stored for 1 to 2h at room condition*.</p>											
11	Vibration Resistance	Appearance	No marked defect								
		Capacitance	Within the specified tolerance								
		D.F.	2.5% max.								
<p>The capacitor should be firmly soldered to the supporting lead wire and vibrated at a frequency range of 10 to 55Hz, 1.5mm in total amplitude, with about a 1-minute rate of vibration change from 10 to 55Hz and back to 10Hz. Apply for a total of 6h, 2h each in 3 mutually perpendicular directions.</p>											
12	Humidity (Under Steady State)	Appearance	No marked defect								
		Capacitance Change	<table border="1" style="margin-left: auto; margin-right: auto;"> <thead> <tr style="background-color: #333; color: white;"> <th>Char.</th> <th>Capacitance Change</th> </tr> </thead> <tbody> <tr> <td>B</td> <td>Within $\pm 10\%$</td> </tr> <tr> <td>E</td> <td>Within $\pm 15\%$</td> </tr> <tr> <td>SL</td> <td>Within $\pm 5\%$</td> </tr> </tbody> </table>	Char.	Capacitance Change	B	Within $\pm 10\%$	E	Within $\pm 15\%$	SL	Within $\pm 5\%$
		Char.	Capacitance Change								
		B	Within $\pm 10\%$								
		E	Within $\pm 15\%$								
SL	Within $\pm 5\%$										
D.F.	<table border="1" style="margin-left: auto; margin-right: auto;"> <thead> <tr style="background-color: #333; color: white;"> <th>Char.</th> <th>Specifications</th> </tr> </thead> <tbody> <tr> <td>B, E</td> <td>D.F. $\leq 5.0\%$</td> </tr> <tr> <td>SL</td> <td>D.F. $\leq 2.5\%$</td> </tr> </tbody> </table>	Char.	Specifications	B, E	D.F. $\leq 5.0\%$	SL	D.F. $\leq 2.5\%$				
Char.	Specifications										
B, E	D.F. $\leq 5.0\%$										
SL	D.F. $\leq 2.5\%$										
I.R.	3000M Ω min.										
Dielectric Strength	Per Item 6										
<p>Set the capacitor for 500\pm12h at 40\pm2°C in 90 to 95% relative humidity.</p> <p>Pre-treatment: Capacitor should be stored at 125\pm2°C for 1h, and apply the AC2000V(r.m.s.) 60s (in case of Type RA, apply the AC4000V(r.m.s.) 60s) then placed at room condition* for 24\pm2h before initial measurements. (Do not apply to SL char.)</p> <p>Post-treatment: Capacitor should be stored for 1 to 2h at room condition*.</p>											
13	Humidity Loading	Appearance	No marked defect								
		Capacitance Change	<table border="1" style="margin-left: auto; margin-right: auto;"> <thead> <tr style="background-color: #333; color: white;"> <th>Char.</th> <th>Capacitance Change</th> </tr> </thead> <tbody> <tr> <td>B</td> <td>Within $\pm 10\%$</td> </tr> <tr> <td>E</td> <td>Within $\pm 15\%$</td> </tr> <tr> <td>SL</td> <td>Within $\pm 5\%$</td> </tr> </tbody> </table>	Char.	Capacitance Change	B	Within $\pm 10\%$	E	Within $\pm 15\%$	SL	Within $\pm 5\%$
		Char.	Capacitance Change								
		B	Within $\pm 10\%$								
		E	Within $\pm 15\%$								
SL	Within $\pm 5\%$										
D.F.	<table border="1" style="margin-left: auto; margin-right: auto;"> <thead> <tr style="background-color: #333; color: white;"> <th>Char.</th> <th>Specifications</th> </tr> </thead> <tbody> <tr> <td>B, E</td> <td>D.F. $\leq 5.0\%$</td> </tr> <tr> <td>SL</td> <td>D.F. $\leq 2.5\%$</td> </tr> </tbody> </table>	Char.	Specifications	B, E	D.F. $\leq 5.0\%$	SL	D.F. $\leq 2.5\%$				
Char.	Specifications										
B, E	D.F. $\leq 5.0\%$										
SL	D.F. $\leq 2.5\%$										
I.R.	3000M Ω min.										
Dielectric Strength	Per Item 6										
<p>Apply the AC440V (r.m.s.) (in case of Type RA: AC500V (r.m.s.)) for 500\pm12h at 40\pm2°C in 90 to 95% relative humidity.</p> <p>Pre-treatment: Capacitor should be stored at 125\pm2°C for 1h, and apply the AC2000V(r.m.s.) 60s (in case of Type RA, apply the AC4000V(r.m.s.) 60s) then placed at room condition* for 24\pm2h before initial measurements. (Do not apply to SL char.)</p> <p>Post-treatment: Capacitor should be stored for 1 to 2h at room condition*.</p>											

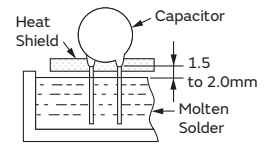

* "Room condition" Temperature: 15 to 35°C, Relative humidity: 45 to 75%, Atmosphere pressure: 86 to 106kPa

Continued on the following page. ↗

Type SA: AC400V / RA: AC500V Specifications and Test Methods

Continued from the preceding page. ↘

No.	Item	Specifications	Test Method																											
17	Passive Flammability	The burning time should not exceed 30s. The tissue paper should not ignite.	<p>The capacitor under test should be held in the flame in the position that best promotes burning. Each specimen should only be exposed once to the flame. Time of exposure to flame: 30s.</p> <p>Length of flame: 12±1mm Gas burner : Length 35mm min. Inside Dia. 0.5±0.1mm Outside Dia. 0.9mm max. Gas : Butane gas Purity 95% min.</p>																											
18	Appearance	No marked defect	<p>The capacitor should be subjected to 5 temperature cycles, then consecutively to 2 immersion cycles.</p> <p><Temperature Cycle></p> <table border="1"> <thead> <tr> <th>Step</th> <th>Temperature (°C)</th> <th>Time (min.)</th> </tr> </thead> <tbody> <tr> <td>1</td> <td>-40+0/-3</td> <td>30</td> </tr> <tr> <td>2</td> <td>Room temp.</td> <td>3</td> </tr> <tr> <td>3</td> <td>125+3/-0</td> <td>30</td> </tr> <tr> <td>4</td> <td>Room temp.</td> <td>3</td> </tr> </tbody> </table> <p>Cycle time: 500 cycles</p> <p><Immersion Cycle></p> <table border="1"> <thead> <tr> <th>Step</th> <th>Temperature (°C)</th> <th>Time (min.)</th> <th>Immersion Water</th> </tr> </thead> <tbody> <tr> <td>1</td> <td>65+5/-0</td> <td>15</td> <td>Clean water</td> </tr> <tr> <td>2</td> <td>0±3</td> <td>15</td> <td>Salt water</td> </tr> </tbody> </table> <p>Cycle time: 2 cycles</p> <p>Pre-treatment: Capacitor should be stored at 125±2°C for 1h, and apply the AC2000V(r.m.s.) 60s (in case of Type RA, apply the AC4000V(r.m.s.) 60s) then placed at room condition* for 24±2h. (Do not apply to SL char.) Post-treatment: Capacitor should be stored for 24±2h at room condition*.</p>	Step	Temperature (°C)	Time (min.)	1	-40+0/-3	30	2	Room temp.	3	3	125+3/-0	30	4	Room temp.	3	Step	Temperature (°C)	Time (min.)	Immersion Water	1	65+5/-0	15	Clean water	2	0±3	15	Salt water
	Step	Temperature (°C)		Time (min.)																										
	1	-40+0/-3		30																										
	2	Room temp.		3																										
	3	125+3/-0		30																										
4	Room temp.	3																												
Step	Temperature (°C)	Time (min.)	Immersion Water																											
1	65+5/-0	15	Clean water																											
2	0±3	15	Salt water																											
Capacitance Change	<table border="1"> <thead> <tr> <th>Char.</th> <th>Capacitance Change</th> </tr> </thead> <tbody> <tr> <td>B</td> <td>Within ±10%</td> </tr> <tr> <td>E</td> <td>Within ±20%</td> </tr> <tr> <td>SL</td> <td>Within ± 5%</td> </tr> </tbody> </table>	Char.	Capacitance Change	B	Within ±10%	E	Within ±20%	SL	Within ± 5%																					
Char.	Capacitance Change																													
B	Within ±10%																													
E	Within ±20%																													
SL	Within ± 5%																													
D.F.	<table border="1"> <thead> <tr> <th>Char.</th> <th>Specifications</th> </tr> </thead> <tbody> <tr> <td>B, E</td> <td>D.F. ≤5.0%</td> </tr> <tr> <td>SL</td> <td>D.F. ≤2.5%</td> </tr> </tbody> </table>	Char.	Specifications	B, E	D.F. ≤5.0%	SL	D.F. ≤2.5%																							
Char.	Specifications																													
B, E	D.F. ≤5.0%																													
SL	D.F. ≤2.5%																													
I.R.	3000MΩ min.																													
Dielectric Strength	Per Item 6																													

* "Room condition" Temperature: 15 to 35°C, Relative humidity: 45 to 75%, Atmosphere pressure: 86 to 106kPa

Safety Standard Certified Lead Type Disc Ceramic Capacitors for General Purpose

Type SA: AC250V or AC300V (Basic Insulation) -Class X1, Y2- (Recommend)

Features

1. For some capacitance, reduced body size than current new "Type KY", reduced the diameter size 1~2mm.
2. Operating temperature range guaranteed up to 125°C.
3. Dielectric strength:
 AC2000V (for lead spacing F=5mm)
 AC2600V (for lead spacing F=7.5mm)
4. Class X1/Y2 capacitors certified by ENEC(VDE)/UL/CQC/KTC.
5. Coated with flame-retardant halogen-free* epoxy resin (conforming to UL94V-0 standard).
 * Cl=900ppm max., Br=900ppm max. and Cl+Br=1500ppm max.
6. Taping available for automatic insertion.
7. Rated Voltage: X1: AC300V(r.m.s.), Y2: AC250V(r.m.s.)
 X1: AC300V(r.m.s.), Y2: AC300V(r.m.s.)

Applications

Ideal for use as X/Y capacitors for AC line filters and primary-secondary coupling on switching power supplies and AC adapters.

Do not use these products in any automotive power train or safety equipment including battery chargers for electric vehicles and plug-in hybrids. Only Murata products clearly stipulated as "for Automotive use" on its catalog can be used for automobile applications such as power train and safety equipment.

Standard Certification Rated Voltage (250Vac)

	Standard No.	Certified No.	Rated Voltage
ENEC (VDE)	EN 60384-14	40042990	250Vac(r.m.s.)
UL	UL 60384-14	E37921	
CQC	IEC 60384-14	CQC15001137840	
KTC	KC 60384-14	HU03008-17009	

* The certification number might change due to revision of the application standard and changes in the range of acquisition.

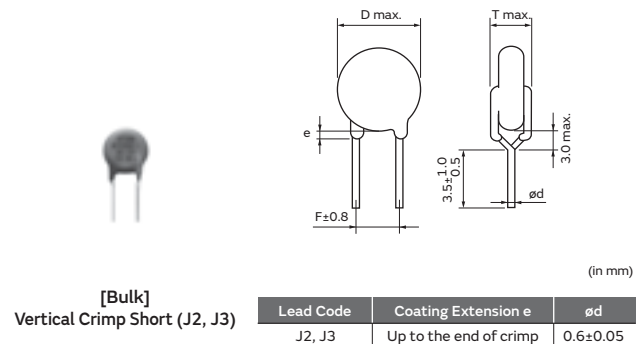
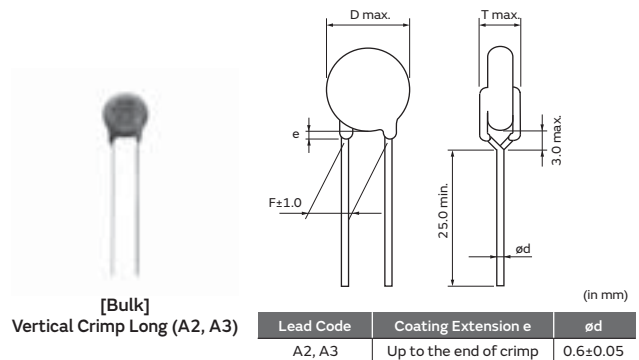

Marking Rated Voltage (250Vac)

Example	Item
	① Type Designation SA
	② Nominal Capacitance (Under 100pF: Actual value, 100pF and over: 3 digit system)
	③ Capacitance Tolerance
	④ Company Name Code ©15: Made in Thailand
	⑤ Manufactured Date Code Class Code X1Y2 Rated Voltage Mark 300~, 250~

Continued on the following page. ↗

Continued from the preceding page. ↘

Standard Certification Rated Voltage (300Vac)

	Standard No.	Certified No.	Rated Voltage
ENEC (VDE)	EN 60384-14	40042990	300Vac(r.m.s.)
UL	UL 60384-14	E37921	
CQC	IEC 60384-14	CQC15001137840	

• The certification number might change due to revision of the application standard and changes in the range of acquisition.

Marking Rated Voltage (300Vac)

Example	Item
	① Type Designation SA
	② Nominal Capacitance (Under 100pF: Actual value, 100pF and over: 3 digit system)
	③ Capacitance Tolerance
	④ Company Name Code <small>©15: Made in Thailand</small>
	⑤ Manufactured Date Code
	Class Code X1Y2
	Rated Voltage Mark 300~

Rated Voltage 250Vac

Lead Spacing F=7.5mm

Part Number	AC Rated Voltage	Temp. Char.	Capacitance	Body Dia. D	Lead Spacing F (mm)	Body Thickness T	Lead Package Long Bulk	Lead Package Short Bulk	Lead Package Taping
DE21XSA100K□□□T02F	250Vac(r.m.s.)	SL	10pF±10%	7.0mm max.	7.5	4.0mm max.	A3B	J3B	N3A
DE21XSA150K□□□T02F	250Vac(r.m.s.)	SL	15pF±10%	6.0mm max.	7.5	5.0mm max.	A3B	J3B	N3A
DE21XSA220K□□□T02F	250Vac(r.m.s.)	SL	22pF±10%	6.0mm max.	7.5	4.0mm max.	A3B	J3B	N3A
DE21XSA330K□□□T02F	250Vac(r.m.s.)	SL	33pF±10%	7.0mm max.	7.5	4.0mm max.	A3B	J3B	N3A
DE21XSA470K□□□T02F	250Vac(r.m.s.)	SL	47pF±10%	7.0mm max.	7.5	4.0mm max.	A3B	J3B	N3A
DE21XSA680K□□□T02F	250Vac(r.m.s.)	SL	68pF±10%	8.0mm max.	7.5	4.0mm max.	A3B	J3B	N3A
DE2B3SA101K□□□T02F	250Vac(r.m.s.)	B	100pF±10%	6.0mm max.	7.5	4.0mm max.	A3B	J3B	N3A
DE2B3SA151K□□□T02F	250Vac(r.m.s.)	B	150pF±10%	6.0mm max.	7.5	4.0mm max.	A3B	J3B	N3A
DE2B3SA221K□□□T02F	250Vac(r.m.s.)	B	220pF±10%	6.0mm max.	7.5	5.0mm max.	A3B	J3B	N3A
DE2B3SA331K□□□T02F	250Vac(r.m.s.)	B	330pF±10%	6.0mm max.	7.5	4.0mm max.	A3B	J3B	N3A
DE2B3SA471K□□□T02F	250Vac(r.m.s.)	B	470pF±10%	7.0mm max.	7.5	4.0mm max.	A3B	J3B	N3A
DE2B3SA681K□□□T02F	250Vac(r.m.s.)	B	680pF±10%	7.0mm max.	7.5	4.0mm max.	A3B	J3B	N3A
DE2E3SA102M□□□T02F	250Vac(r.m.s.)	E	1000pF±20%	6.0mm max.	7.5	4.0mm max.	A3B	J3B	N3A
DE2E3SA152M□□□T02F	250Vac(r.m.s.)	E	1500pF±20%	7.0mm max.	7.5	4.0mm max.	A3B	J3B	N3A
DE2E3SA222M□□□T02F	250Vac(r.m.s.)	E	2200pF±20%	8.0mm max.	7.5	4.0mm max.	A3B	J3B	N3A
DE2E3SA332M□□□T02F	250Vac(r.m.s.)	E	3300pF±20%	9.0mm max.	7.5	4.0mm max.	A3B	J3B	N3A
DE2E3SA472M□□□T02F	250Vac(r.m.s.)	E	4700pF±20%	10.0mm max.	7.5	5.0mm max.	A3B	J3B	N3A
DE2E3SA103M□□□T02F	250Vac(r.m.s.)	E	10000pF±20%	15.0mm max.	7.5	5.0mm max.	A3B	J3B	N7A

Three blank columns are filled with the lead and packaging codes. Please refer to the 3 columns on the right for the appropriate codes.

Individual specification code "T02F" express "simplicity marking and guarantee of dielectric strength between lead wires: AC2600V."

Murata part numbers might be changed depending on lead code or any other changes. Therefore, please specify only the type name (SA) and capacitance of products in the part list when it is required for applying safety standard of electric equipments.

Continued on the following page. ↗

Continued from the preceding page. ↘

Lead Spacing F=5mm

Part Number	AC Rated Voltage	Temp. Char.	Capacitance	Body Dia. D	Lead Spacing F (mm)	Body Thickness T	Lead Package Long Bulk	Lead Package Short Bulk	Lead Package Taping
DE21XSA100K□□□T01F	250Vac(r.m.s.)	SL	10pF±10%	7.0mm max.	5.0	4.0mm max.	A2B	J2B	N2A
DE21XSA150K□□□T01F	250Vac(r.m.s.)	SL	15pF±10%	6.0mm max.	5.0	5.0mm max.	A2B	J2B	N2A
DE21XSA220K□□□T01F	250Vac(r.m.s.)	SL	22pF±10%	6.0mm max.	5.0	4.0mm max.	A2B	J2B	N2A
DE21XSA330K□□□T01F	250Vac(r.m.s.)	SL	33pF±10%	7.0mm max.	5.0	4.0mm max.	A2B	J2B	N2A
DE21XSA470K□□□T01F	250Vac(r.m.s.)	SL	47pF±10%	7.0mm max.	5.0	4.0mm max.	A2B	J2B	N2A
DE21XSA680K□□□T01F	250Vac(r.m.s.)	SL	68pF±10%	8.0mm max.	5.0	4.0mm max.	A2B	J2B	N2A
DE2B3SA101K□□□T01F	250Vac(r.m.s.)	B	100pF±10%	6.0mm max.	5.0	4.0mm max.	A2B	J2B	N2A
DE2B3SA151K□□□T01F	250Vac(r.m.s.)	B	150pF±10%	6.0mm max.	5.0	4.0mm max.	A2B	J2B	N2A
DE2B3SA221K□□□T01F	250Vac(r.m.s.)	B	220pF±10%	6.0mm max.	5.0	5.0mm max.	A2B	J2B	N2A
DE2B3SA331K□□□T01F	250Vac(r.m.s.)	B	330pF±10%	6.0mm max.	5.0	4.0mm max.	A2B	J2B	N2A
DE2B3SA471K□□□T01F	250Vac(r.m.s.)	B	470pF±10%	7.0mm max.	5.0	4.0mm max.	A2B	J2B	N2A
DE2B3SA681K□□□T01F	250Vac(r.m.s.)	B	680pF±10%	7.0mm max.	5.0	4.0mm max.	A2B	J2B	N2A
DE2E3SA102M□□□T01F	250Vac(r.m.s.)	E	1000pF±20%	6.0mm max.	5.0	4.0mm max.	A2B	J2B	N2A
DE2E3SA152M□□□T01F	250Vac(r.m.s.)	E	1500pF±20%	7.0mm max.	5.0	4.0mm max.	A2B	J2B	N2A
DE2E3SA222M□□□T01F	250Vac(r.m.s.)	E	2200pF±20%	8.0mm max.	5.0	4.0mm max.	A2B	J2B	N2A
DE2E3SA332M□□□T01F	250Vac(r.m.s.)	E	3300pF±20%	9.0mm max.	5.0	4.0mm max.	A2B	J2B	N2A
DE2E3SA472M□□□T01F	250Vac(r.m.s.)	E	4700pF±20%	10.0mm max.	5.0	5.0mm max.	A2B	J2B	N2A

Three blank columns are filled with the lead and packaging codes. Please refer to the 3 columns on the right for the appropriate codes.
 Individual specification code "T01F" express "simplicity marking and guarantee of dielectric strength between lead wires: AC2000V."
 Murata part numbers might be changed depending on lead code or any other changes. Therefore, please specify only the type name (SA) and capacitance of products in the part list when it is required for applying safety standard of electric equipments.

Rated Voltage 300Vac

Lead Spacing F=7.5mm

Part Number	AC Rated Voltage	Temp. Char.	Capacitance	Body Dia. D	Lead Spacing F (mm)	Body Thickness T	Lead Package Long Bulk	Lead Package Short Bulk	Lead Package Taping
DE21XSA100K□□□X02F	300Vac(r.m.s.)	SL	10pF±10%	7.0mm max.	7.5	4.0mm max.	A3B	J3B	N3A
DE21XSA150K□□□X02F	300Vac(r.m.s.)	SL	15pF±10%	6.0mm max.	7.5	5.0mm max.	A3B	J3B	N3A
DE21XSA220K□□□X02F	300Vac(r.m.s.)	SL	22pF±10%	6.0mm max.	7.5	4.0mm max.	A3B	J3B	N3A
DE21XSA330K□□□X02F	300Vac(r.m.s.)	SL	33pF±10%	7.0mm max.	7.5	4.0mm max.	A3B	J3B	N3A
DE21XSA470K□□□X02F	300Vac(r.m.s.)	SL	47pF±10%	7.0mm max.	7.5	4.0mm max.	A3B	J3B	N3A
DE21XSA680K□□□X02F	300Vac(r.m.s.)	SL	68pF±10%	8.0mm max.	7.5	4.0mm max.	A3B	J3B	N3A
DE2B3SA101K□□□X02F	300Vac(r.m.s.)	B	100pF±10%	6.0mm max.	7.5	4.0mm max.	A3B	J3B	N3A
DE2B3SA151K□□□X02F	300Vac(r.m.s.)	B	150pF±10%	6.0mm max.	7.5	4.0mm max.	A3B	J3B	N3A
DE2B3SA221K□□□X02F	300Vac(r.m.s.)	B	220pF±10%	6.0mm max.	7.5	5.0mm max.	A3B	J3B	N3A
DE2B3SA331K□□□X02F	300Vac(r.m.s.)	B	330pF±10%	6.0mm max.	7.5	4.0mm max.	A3B	J3B	N3A
DE2B3SA471K□□□X02F	300Vac(r.m.s.)	B	470pF±10%	7.0mm max.	7.5	4.0mm max.	A3B	J3B	N3A
DE2B3SA681K□□□X02F	300Vac(r.m.s.)	B	680pF±10%	7.0mm max.	7.5	4.0mm max.	A3B	J3B	N3A
DE2E3SA102M□□□X02F	300Vac(r.m.s.)	E	1000pF±20%	6.0mm max.	7.5	4.0mm max.	A3B	J3B	N3A
DE2E3SA152M□□□X02F	300Vac(r.m.s.)	E	1500pF±20%	7.0mm max.	7.5	4.0mm max.	A3B	J3B	N3A
DE2E3SA222M□□□X02F	300Vac(r.m.s.)	E	2200pF±20%	8.0mm max.	7.5	4.0mm max.	A3B	J3B	N3A
DE2E3SA332M□□□X02F	300Vac(r.m.s.)	E	3300pF±20%	9.0mm max.	7.5	4.0mm max.	A3B	J3B	N3A
DE2E3SA472M□□□X02F	300Vac(r.m.s.)	E	4700pF±20%	10.0mm max.	7.5	5.0mm max.	A3B	J3B	N3A
DE2E3SA103M□□□X02F	300Vac(r.m.s.)	E	10000pF±20%	15.0mm max.	7.5	5.0mm max.	A3B	J3B	N7A

Three blank columns are filled with the lead and packaging codes. Please refer to the 3 columns on the right for the appropriate codes.
 Individual specification code "X02F" express "simplicity marking and guarantee of dielectric strength between lead wires: AC2600V."
 Murata part numbers might be changed depending on lead code or any other changes. Therefore, please specify only the type name (SA) and capacitance of products in the part list when it is required for applying safety standard of electric equipments.

Safety Standard Certified Lead Type Disc Ceramic Capacitors for General Purpose

Type RA: AC250V or AC300V (Reinforced Insulation) -Class X1, Y1- (Recommend)

Features

1. For some capacitance, Reduced body size than current new small "Type KX", reduced the diameter size 1~2mm.
2. Operating temperature range guaranteed up to 125°C.
3. Dielectric strength: AC4000V
4. Class X1/Y1 capacitors certified by ENEC(VDE)/UL/CQC/KTC.
5. Can be use with a component in appliances requiring reinforced insulation and double insulation based on UL1492, IEC60065 and IEC60950.
6. Coated with flame-retardant halogen-free* epoxy resin (conforming to UL94V-0 standard).
 * Cl=900ppm max., Br=900ppm max. and Cl+Br=1500ppm max.
7. Taping available for automatic insertion.
8. Rated Voltage: X1: AC440V(r.m.s.), Y1: AC250V(r.m.s.) or X1: AC440V(r.m.s.), Y1: AC300V(r.m.s.)

Applications

Ideal for use as X/Y capacitors for AC line filters and primary-secondary coupling on switching power supplies and AC adapters.

Do not use these products in any automotive power train or safety equipment including battery chargers for electric vehicles and plug-in hybrids. Only Murata products clearly stipulated as "for Automotive use" on its catalog can be used for automobile applications such as power train and safety equipment.

Standard Certification Rated Voltage (250Vac)

	Standard No.	Certified No.	Rated Voltage
ENEC (VDE)	EN 60384-14	40043033	250Vac(r.m.s.)
UL	UL 60384-14	E37921	
CQC	IEC 60384-14	CQC16001138225	
KTC	KC 60384-14	HU03008-17008	

* The certification number might change due to revision of the application standard and changes in the range of acquisition.

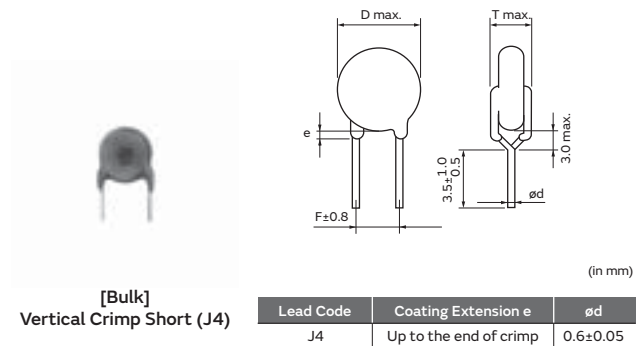
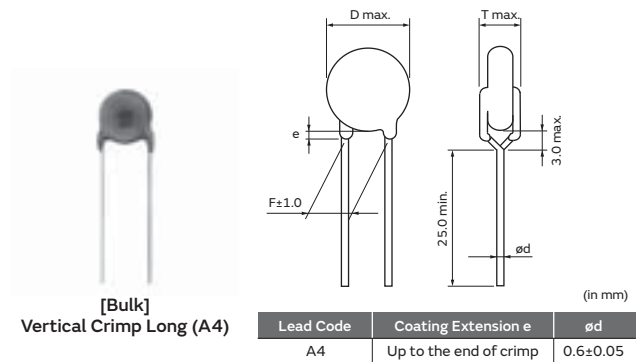

Marking Rated Voltage (250Vac)

Example	Item
	① Type Designation RA
	② Nominal Capacitance (Under 100pF: Actual value, 100pF and over: 3 digit system)
	③ Capacitance Tolerance
	④ Company Name Code M15: Made in Thailand
	⑤ Manufactured Date Code
Class Code X1Y1	
Rated Voltage Mark 440~, 250~	

Continued on the following page. ↗

Continued from the preceding page. ↘

Standard Certification Rated Voltage (300Vac)

	Standard No.	Certified No.	Rated Voltage
ENEC (VDE)	EN 60384-14	40043033	300Vac(r.m.s.)
UL	UL 60384-14	E37921	
CQC	IEC 60384-14	CQC16001138225	

• The certification number might change due to revision of the application standard and changes in the range of acquisition.

Marking Rated Voltage (300Vac)

Example	Item
	① Type Designation RA
	② Nominal Capacitance (Under 100pF: Actual value, 100pF and over: 3 digit system)
	③ Capacitance Tolerance
	④ Company Name Code M15: Made in Thailand
	⑤ Manufactured Date Code
	Class Code X1Y1
Rated Voltage Mark 440~, 300~	

Rated Voltage 250Vac

Part Number	AC Rated Voltage	Temp. Char.	Capacitance	Body Dia. D	Lead Spacing F (mm)	Body Thickness T	Lead Package Long Bulk	Lead Package Short Bulk	Lead Package Taping
DE11XRA100K□□□N01F	250Vac(r.m.s.)	SL	10pF±10%	7.0mm max.	10.0	4.0mm max.	A4B	J4B	N4A
DE11XRA150K□□□N01F	250Vac(r.m.s.)	SL	15pF±10%	6.0mm max.	10.0	5.0mm max.	A4B	J4B	N4A
DE11XRA220K□□□N01F	250Vac(r.m.s.)	SL	22pF±10%	6.0mm max.	10.0	4.0mm max.	A4B	J4B	N4A
DE11XRA330K□□□N01F	250Vac(r.m.s.)	SL	33pF±10%	7.0mm max.	10.0	4.0mm max.	A4B	J4B	N4A
DE11XRA470K□□□N01F	250Vac(r.m.s.)	SL	47pF±10%	7.0mm max.	10.0	4.0mm max.	A4B	J4B	N4A
DE11XRA680K□□□N01F	250Vac(r.m.s.)	SL	68pF±10%	8.0mm max.	10.0	4.0mm max.	A4B	J4B	N4A
DE1B3RA101K□□□N01F	250Vac(r.m.s.)	B	100pF±10%	6.0mm max.	10.0	4.0mm max.	A4B	J4B	N4A
DE1B3RA151K□□□N01F	250Vac(r.m.s.)	B	150pF±10%	7.0mm max.	10.0	4.0mm max.	A4B	J4B	N4A
DE1B3RA221K□□□N01F	250Vac(r.m.s.)	B	220pF±10%	6.0mm max.	10.0	5.0mm max.	A4B	J4B	N4A
DE1B3RA331K□□□N01F	250Vac(r.m.s.)	B	330pF±10%	6.0mm max.	10.0	5.0mm max.	A4B	J4B	N4A
DE1B3RA471K□□□N01F	250Vac(r.m.s.)	B	470pF±10%	7.0mm max.	10.0	5.0mm max.	A4B	J4B	N4A
DE1B3RA681K□□□N01F	250Vac(r.m.s.)	B	680pF±10%	8.0mm max.	10.0	5.0mm max.	A4B	J4B	N4A
DE1E3RA102M□□□N01F	250Vac(r.m.s.)	E	1000pF±20%	7.0mm max.	10.0	4.0mm max.	A4B	J4B	N4A
DE1E3RA152M□□□N01F	250Vac(r.m.s.)	E	1500pF±20%	8.0mm max.	10.0	4.0mm max.	A4B	J4B	N4A
DE1E3RA222M□□□N01F	250Vac(r.m.s.)	E	2200pF±20%	9.0mm max.	10.0	4.0mm max.	A4B	J4B	N4A
DE1E3RA332M□□□N01F	250Vac(r.m.s.)	E	3300pF±20%	10.0mm max.	10.0	5.0mm max.	A4B	J4B	N4A
DE1E3RA472M□□□N01F	250Vac(r.m.s.)	E	4700pF±20%	12.0mm max.	10.0	5.0mm max.	A4B	J4B	N4A

Three blank columns are filled with the lead and packaging codes. Please refer to the 3 columns on the right for the appropriate codes.

Murata part numbers might be changed depending on lead code or any other changes. Therefore, please specify only the type name (RA) and capacitance of products in the part list when it is required for applying safety standard of electric equipments.

Continued on the following page. ↗

Continued from the preceding page. ↘

Rated Voltage 300Vac

Part Number	AC Rated Voltage	Temp. Char.	Capacitance	Body Dia. D	Lead Spacing F (mm)	Body Thickness T	Lead Package Long Bulk	Lead Package Short Bulk	Lead Package Taping
DE11XRA100K□□□P01F	300Vac(r.m.s.)	SL	10pF±10%	7.0mm max.	10.0	4.0mm max.	A4B	J4B	N4A
DE11XRA150K□□□P01F	300Vac(r.m.s.)	SL	15pF±10%	6.0mm max.	10.0	5.0mm max.	A4B	J4B	N4A
DE11XRA220K□□□P01F	300Vac(r.m.s.)	SL	22pF±10%	6.0mm max.	10.0	4.0mm max.	A4B	J4B	N4A
DE11XRA330K□□□P01F	300Vac(r.m.s.)	SL	33pF±10%	7.0mm max.	10.0	4.0mm max.	A4B	J4B	N4A
DE11XRA470K□□□P01F	300Vac(r.m.s.)	SL	47pF±10%	7.0mm max.	10.0	4.0mm max.	A4B	J4B	N4A
DE11XRA680K□□□P01F	300Vac(r.m.s.)	SL	68pF±10%	8.0mm max.	10.0	4.0mm max.	A4B	J4B	N4A
DE1B3RA101K□□□P01F	300Vac(r.m.s.)	B	100pF±10%	6.0mm max.	10.0	4.0mm max.	A4B	J4B	N4A
DE1B3RA151K□□□P01F	300Vac(r.m.s.)	B	150pF±10%	7.0mm max.	10.0	4.0mm max.	A4B	J4B	N4A
DE1B3RA221K□□□P01F	300Vac(r.m.s.)	B	220pF±10%	6.0mm max.	10.0	5.0mm max.	A4B	J4B	N4A
DE1B3RA331K□□□P01F	300Vac(r.m.s.)	B	330pF±10%	6.0mm max.	10.0	5.0mm max.	A4B	J4B	N4A
DE1B3RA471K□□□P01F	300Vac(r.m.s.)	B	470pF±10%	7.0mm max.	10.0	5.0mm max.	A4B	J4B	N4A
DE1B3RA681K□□□P01F	300Vac(r.m.s.)	B	680pF±10%	8.0mm max.	10.0	5.0mm max.	A4B	J4B	N4A
DE1E3RA102M□□□P01F	300Vac(r.m.s.)	E	1000pF±20%	7.0mm max.	10.0	4.0mm max.	A4B	J4B	N4A
DE1E3RA152M□□□P01F	300Vac(r.m.s.)	E	1500pF±20%	8.0mm max.	10.0	4.0mm max.	A4B	J4B	N4A
DE1E3RA222M□□□P01F	300Vac(r.m.s.)	E	2200pF±20%	9.0mm max.	10.0	4.0mm max.	A4B	J4B	N4A
DE1E3RA332M□□□P01F	300Vac(r.m.s.)	E	3300pF±20%	10.0mm max.	10.0	5.0mm max.	A4B	J4B	N4A
DE1E3RA472M□□□P01F	300Vac(r.m.s.)	E	4700pF±20%	12.0mm max.	10.0	5.0mm max.	A4B	J4B	N4A

Three blank columns are filled with the lead and packaging codes. Please refer to the 3 columns on the right for the appropriate codes.

Murata part numbers might be changed depending on lead code or any other changes. Therefore, please specify only the type name (RA) and capacitance of products in the part list when it is required for applying safety standard of electric equipments.

Type SA: AC250V or AC300V / RA: AC250V or AC300V Specifications and Test Methods

Operating Temperature Range: -40 to +125°C

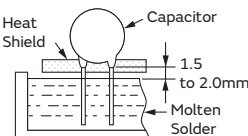
No.	Item	Specifications	Test Method																						
1	Appearance and Dimensions	No visible defect, and dimensions are within specified range.	The capacitor should be visually inspected for evidence of defect. Dimensions should be measured with slide calipers.																						
2	Marking	To be easily legible	The capacitor should be visually inspected.																						
3	Capacitance	Within specified tolerance	The capacitance, dissipation factor should be measured at 20°C with 1±0.1kHz and AC1±0.2V(r.m.s.) max.																						
4	Dissipation Factor (D.F.)	2.5% max.																							
5	Insulation Resistance (I.R.)	10000MΩ min.	The insulation resistance should be measured with DC500±50V within 60±5s of charging. The voltage should be applied to the capacitor through a resistor of 1MΩ.																						
6	Between Lead Wires	No failure	The capacitor should not be damaged when the test voltages from Table 1 are applied between the lead wires for 60s. <div style="text-align: center;"> <table border="1" style="margin: auto;"> <thead> <tr> <th style="background-color: #333; color: white;">Type</th> <th style="background-color: #333; color: white;">Test Voltage</th> </tr> </thead> <tbody> <tr> <td>SA</td> <td>For lead spacing F=5mm AC2000V(r.m.s.) <50/60Hz> For lead spacing F=7.5mm AC2600V(r.m.s.) <50/60Hz></td> </tr> <tr> <td>RA</td> <td>AC4000V(r.m.s.) <50/60Hz></td> </tr> </tbody> </table> </div>	Type	Test Voltage	SA	For lead spacing F=5mm AC2000V(r.m.s.) <50/60Hz> For lead spacing F=7.5mm AC2600V(r.m.s.) <50/60Hz>	RA	AC4000V(r.m.s.) <50/60Hz>																
	Type	Test Voltage																							
SA	For lead spacing F=5mm AC2000V(r.m.s.) <50/60Hz> For lead spacing F=7.5mm AC2600V(r.m.s.) <50/60Hz>																								
RA	AC4000V(r.m.s.) <50/60Hz>																								
Body Insulation	No failure	First, the terminals of the capacitor should be connected together. Then, as shown in the figure at right, a metal foil should be closely wrapped around the body of the capacitor to the distance of about 3 to 4mm (in case of Type RA: 3 to 6mm) from each terminal. Then, the capacitor should be inserted into a container filled with metal balls of about 1mm diameter. Finally, AC voltage from Table 2 is applied for 60s between the capacitor lead wires and metal balls. <div style="text-align: center;"> <table border="1" style="margin: auto;"> <thead> <tr> <th style="background-color: #333; color: white;">Type</th> <th style="background-color: #333; color: white;">Test Voltage</th> </tr> </thead> <tbody> <tr> <td>SA</td> <td>AC2600V(r.m.s.) <50/60Hz></td> </tr> <tr> <td>RA</td> <td>AC4000V(r.m.s.) <50/60Hz></td> </tr> </tbody> </table> </div>	Type	Test Voltage	SA	AC2600V(r.m.s.) <50/60Hz>	RA	AC4000V(r.m.s.) <50/60Hz>																	
Type	Test Voltage																								
SA	AC2600V(r.m.s.) <50/60Hz>																								
RA	AC4000V(r.m.s.) <50/60Hz>																								
7	Temperature Characteristics	<table border="1" style="margin: auto;"> <thead> <tr> <th style="background-color: #333; color: white;">Char.</th> <th style="background-color: #333; color: white;">Capacitance Change</th> </tr> </thead> <tbody> <tr> <td>B</td> <td>Within ±10%</td> </tr> <tr> <td>E</td> <td>Within ±20%</td> </tr> </tbody> </table> (Temp. range: -25 to +85°C) <table border="1" style="margin: auto;"> <thead> <tr> <th style="background-color: #333; color: white;">Char.</th> <th style="background-color: #333; color: white;">Temperature Coefficient</th> </tr> </thead> <tbody> <tr> <td>SL</td> <td>+350 to -1000ppm/°C</td> </tr> </tbody> </table> (Temp. range: +20 to +85°C)	Char.	Capacitance Change	B	Within ±10%	E	Within ±20%	Char.	Temperature Coefficient	SL	+350 to -1000ppm/°C	The capacitance measurement should be made at each step specified in Table 3. <div style="text-align: center;"> <table border="1" style="margin: auto;"> <thead> <tr> <th style="background-color: #333; color: white;">Step</th> <th style="background-color: #333; color: white;">Temperature (°C)</th> </tr> </thead> <tbody> <tr><td>1</td><td>20±2</td></tr> <tr><td>2</td><td>-25±2</td></tr> <tr><td>3</td><td>20±2</td></tr> <tr><td>4</td><td>85±2</td></tr> <tr><td>5</td><td>20±2</td></tr> </tbody> </table> </div>	Step	Temperature (°C)	1	20±2	2	-25±2	3	20±2	4	85±2	5	20±2
Char.	Capacitance Change																								
B	Within ±10%																								
E	Within ±20%																								
Char.	Temperature Coefficient																								
SL	+350 to -1000ppm/°C																								
Step	Temperature (°C)																								
1	20±2																								
2	-25±2																								
3	20±2																								
4	85±2																								
5	20±2																								
8	Solderability of Leads	Lead wire should be soldered with uniform coating on the axial direction over 3/4 of the circumferential direction.	The lead wire of a capacitor should be dipped into molten solder for 2±0.5s. The depth of immersion is up to about 1.5 to 2.0mm from the root of lead wires. Temp. of solder: Lead Free Solder (Sn-3Ag-0.5Cu) 245±5°C																						
9	Appearance	No marked defect	Solder Temperature : 350±10°C or 260±5°C Immersion time : 3.5±0.5s (In case of 260±5°C : 10±1s) The depth of immersion is up to about 1.5 to 2.0mm from the roof of lead wires. <div style="text-align: center;">  </div>																						
	Capacitance Change	Within ±10%																							
	I.R.	1000MΩ min.																							
	Soldering Effect (Non-Preheat)	Dielectric Strength		Per Item 6																					
			Pre-treatment: Capacitor should be stored at 125±2°C for 1h, and apply the AC2000V(r.m.s.) 60s (in case of Type RA, apply the AC4000V(r.m.s.) 60s) then placed at room condition* for 24±2h before initial measurements. (Do not apply to SL char.) Post-treatment: Capacitor should be stored for 1 to 2h at room condition*.																						

* "Room condition" Temperature: 15 to 35°C, Relative humidity: 45 to 75%, Atmosphere pressure: 86 to 106kPa

Continued on the following page. ➔

Type SA: AC250V or AC300V / RA: AC250V or AC300V Specifications and Test Methods

Continued from the preceding page. ↘

No.	Item	Specifications	Test Method								
10	Soldering Effect (On-Preheat)	Appearance	No marked defect								
		Capacitance Change	Within $\pm 10\%$								
		I.R.	1000M Ω min.								
		Dielectric Strength	Per Item 6								
<p>First the capacitor should be stored at $120+0/-5^{\circ}\text{C}$ for 60+0/-5s. Then, as in the figure, the lead wires should be immersed in solder of $260+0/-5^{\circ}\text{C}$ up to 1.5 to 2.0mm from the root of terminal for 7.5+0/-1s.</p> <p>Pre-treatment: Capacitor should be stored at $125\pm 2^{\circ}\text{C}$ for 1h, and apply the AC2000V(r.m.s.) 60s (in case of Type RA, apply the AC4000V(r.m.s.) 60s) then placed at room condition* for 24\pm2h before initial measurements. (Do not apply to SL char.)</p> <p>Post-treatment: Capacitor should be stored for 1 to 2h at room condition*.</p>											
11	Vibration Resistance	Appearance	No marked defect								
		Capacitance	Within the specified tolerance								
		D.F.	2.5% max.								
<p>The capacitor should be firmly soldered to the supporting lead wire and vibrated at a frequency range of 10 to 55Hz, 1.5mm in total amplitude, with about a 1-minute rate of vibration change from 10 to 55Hz and back to 10Hz. Apply for a total of 6h, 2h each in 3 mutually perpendicular directions.</p>											
12	Humidity (Under Steady State)	Appearance	No marked defect								
		Capacitance Change	<table border="1" style="margin-left: auto; margin-right: auto;"> <thead> <tr style="background-color: #333; color: white;"> <th>Char.</th> <th>Capacitance Change</th> </tr> </thead> <tbody> <tr> <td>B</td> <td>Within $\pm 10\%$</td> </tr> <tr> <td>E</td> <td>Within $\pm 15\%$</td> </tr> <tr> <td>SL</td> <td>Within $\pm 5\%$</td> </tr> </tbody> </table>	Char.	Capacitance Change	B	Within $\pm 10\%$	E	Within $\pm 15\%$	SL	Within $\pm 5\%$
		Char.	Capacitance Change								
		B	Within $\pm 10\%$								
		E	Within $\pm 15\%$								
SL	Within $\pm 5\%$										
D.F.	<table border="1" style="margin-left: auto; margin-right: auto;"> <thead> <tr style="background-color: #333; color: white;"> <th>Char.</th> <th>Specifications</th> </tr> </thead> <tbody> <tr> <td>B, E</td> <td>D.F. $\leq 5.0\%$</td> </tr> <tr> <td>SL</td> <td>D.F. $\leq 2.5\%$</td> </tr> </tbody> </table>	Char.	Specifications	B, E	D.F. $\leq 5.0\%$	SL	D.F. $\leq 2.5\%$				
Char.	Specifications										
B, E	D.F. $\leq 5.0\%$										
SL	D.F. $\leq 2.5\%$										
I.R.	3000M Ω min.										
Dielectric Strength	Per Item 6										
<p>Set the capacitor for 500\pm12h at $40\pm 2^{\circ}\text{C}$ in 90 to 95% relative humidity.</p> <p>Pre-treatment: Capacitor should be stored at $125\pm 2^{\circ}\text{C}$ for 1h, and apply the AC2000V(r.m.s.) 60s (in case of Type RA, apply the AC4000V(r.m.s.) 60s) then placed at room condition* for 24\pm2h before initial measurements. (Do not apply to SL char.)</p> <p>Post-treatment: Capacitor should be stored for 1 to 2h at room condition*.</p>											
13	Humidity Loading	Appearance	No marked defect								
		Capacitance Change	<table border="1" style="margin-left: auto; margin-right: auto;"> <thead> <tr style="background-color: #333; color: white;"> <th>Char.</th> <th>Capacitance Change</th> </tr> </thead> <tbody> <tr> <td>B</td> <td>Within $\pm 10\%$</td> </tr> <tr> <td>E</td> <td>Within $\pm 15\%$</td> </tr> <tr> <td>SL</td> <td>Within $\pm 5\%$</td> </tr> </tbody> </table>	Char.	Capacitance Change	B	Within $\pm 10\%$	E	Within $\pm 15\%$	SL	Within $\pm 5\%$
		Char.	Capacitance Change								
		B	Within $\pm 10\%$								
		E	Within $\pm 15\%$								
SL	Within $\pm 5\%$										
D.F.	<table border="1" style="margin-left: auto; margin-right: auto;"> <thead> <tr style="background-color: #333; color: white;"> <th>Char.</th> <th>Specifications</th> </tr> </thead> <tbody> <tr> <td>B, E</td> <td>D.F. $\leq 5.0\%$</td> </tr> <tr> <td>SL</td> <td>D.F. $\leq 2.5\%$</td> </tr> </tbody> </table>	Char.	Specifications	B, E	D.F. $\leq 5.0\%$	SL	D.F. $\leq 2.5\%$				
Char.	Specifications										
B, E	D.F. $\leq 5.0\%$										
SL	D.F. $\leq 2.5\%$										
I.R.	3000M Ω min.										
Dielectric Strength	Per Item 6										
<p>Apply the AC300V (r.m.s.) (in case of Type RA: AC440V (r.m.s.)) for 500\pm12h at $40\pm 2^{\circ}\text{C}$ in 90 to 95% relative humidity.</p> <p>Pre-treatment: Capacitor should be stored at $125\pm 2^{\circ}\text{C}$ for 1h, and apply the AC2000V(r.m.s.) 60s (in case of Type RA, apply the AC4000V(r.m.s.) 60s) then placed at room condition* for 24\pm2h before initial measurements. (Do not apply to SL char.)</p> <p>Post-treatment: Capacitor should be stored for 1 to 2h at room condition*.</p>											

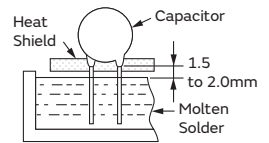

* "Room condition" Temperature: 15 to 35°C, Relative humidity: 45 to 75%, Atmosphere pressure: 86 to 106kPa

Continued on the following page. ↗

Type SA: AC250V or AC300V / RA: AC250V or AC300V Specifications and Test Methods

Continued from the preceding page. ↘

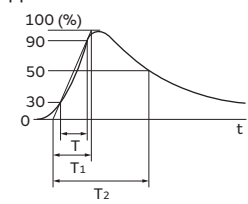
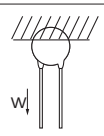
No.	Item	Specifications	Test Method						
14	Life	<table border="1" style="width: 100%; border-collapse: collapse;"> <tr> <td style="width: 15%;">Appearance</td> <td>No marked defect</td> </tr> <tr> <td>Capacitance Change</td> <td>Within $\pm 20\%$</td> </tr> <tr> <td>I.R.</td> <td>3000MΩ min.</td> </tr> </table>	Appearance	No marked defect	Capacitance Change	Within $\pm 20\%$	I.R.	3000M Ω min.	<p>Impulse Voltage Each individual capacitor should be subjected to a 5kV (Type RA: 8kV) impulses for three times. Then the capacitors are applied to life test.</p> <div style="text-align: center;">  </div> <p style="text-align: right;">Front time (T1) = 1.2μs = 1.67T Time to half-value (T2) = 50μs</p> <p>Apply a voltage from Table 4 for 1000h at 125+2/-0°C, and relative humidity of 50% max.</p> <p style="text-align: center;"><Table 4></p> <div style="background-color: #ccc; padding: 2px; margin-bottom: 2px;"> In Case of Type SA rated voltage: AC250V AC425V(r.m.s.) <50/60Hz> except that once each hour the voltage is increased to AC1000V(r.m.s.) for 0.1 sec. </div> <div style="background-color: #ccc; padding: 2px; margin-bottom: 2px;"> In Case of Type SA rated voltage: AC300V AC510V(r.m.s.) <50/60Hz> except that once each hour the voltage is increased to AC1000V(r.m.s.) for 0.1 sec. </div> <div style="background-color: #ccc; padding: 2px;"> In Case of Type RA rated voltage: AC250V or AC300V AC550V(r.m.s.) <50/60Hz> except that once each hour the voltage is increased to AC1000V(r.m.s.) for 0.1 sec. </div> <p>Pre-treatment: Capacitor should be stored at 125\pm2°C for 1h, and apply the AC2000V(r.m.s.) 60s (in case of Type RA, apply the AC4000V(r.m.s.) 60s) then placed at room condition* for 24\pm2h before initial measurements. (Do not apply to SL char.)</p> <p>Post-treatment: Capacitor should be stored for 24h at room condition*.</p>
	Appearance	No marked defect							
Capacitance Change	Within $\pm 20\%$								
I.R.	3000M Ω min.								
	Dielectric Strength	Per Item 6							
15	Robustness of Terminations	<table border="1" style="width: 100%; border-collapse: collapse;"> <tr> <td style="width: 15%;">Tensile</td> <td rowspan="2">Lead wire should not be cut off. Capacitor should not be broken.</td> </tr> <tr> <td>Bending</td> </tr> </table>	Tensile	Lead wire should not be cut off. Capacitor should not be broken.	Bending	<p>As shown in the figure at right, fix the body of the capacitor and apply a tensile weight gradually to each lead wire in the radial direction of the capacitor up to 10N and keep it for 10\pm1s.</p> <div style="text-align: right;">  </div> <p>Each lead wire should be subjected to 5N of weight and bent 90° at the point of egress, in one direction, then returned to its original position and bent 90° in the opposite direction at the rate of one bend in 2 to 3s.</p>			
	Tensile	Lead wire should not be cut off. Capacitor should not be broken.							
Bending									

* "Room condition" Temperature: 15 to 35°C, Relative humidity: 45 to 75%, Atmosphere pressure: 86 to 106kPa

Continued on the following page. ↗

Safety Standard Certified Lead Type Disc Ceramic Capacitors for General Purpose

Type RB: X1: AC760V (Reinforced Insulation) -Class X1, Y1- (Recommend)

Features

1. Operating temperature range guaranteed up to 125°C.
2. Dielectric strength: AC4000V
3. Class X1/Y1 capacitors certified by ENEC(VDE)/UL/CQC.
4. Can be use with a component in appliances requiring reinforced insulation and double insulation based on UL1492, IEC60065 and IEC60950.
5. Coated with flame-retardant halogen-free* epoxy resin (conforming to UL94V-0 standard).
 * Cl=900ppm max., Br=900ppm max. and Cl+Br=1500ppm max.
6. Taping available for automatic insertion.
7. Rated Voltage: X1: AC760V(r.m.s.), Y1: AC500V(r.m.s.)

Applications

Possible to use for X/Y capacitors for AC line filters and capacitors for primary and secondary coupling, use in industrial devices such as inverters for motor control.

Do not use these products in any automotive power train or safety equipment including battery chargers for electric vehicles and plug-in hybrids. Only Murata products clearly stipulated as "for Automotive use" on its catalog can be used for automobile applications such as power train and safety equipment.

Standard Certification

	Standard No.	Certified No.	Rated Voltage
UL/cUL	UL 60384-14	E37921	X1:760Vac(r.m.s.) Y1:500Vac(r.m.s.)
ENEC (VDE)	DIN 60384-14	40046675	
	EN 60384-14 IEC 60384-14		
CQC	IEC 60384-14	CQC17001178139	

* The certification number might change due to revision of the application standard and changes in the range of acquisition.

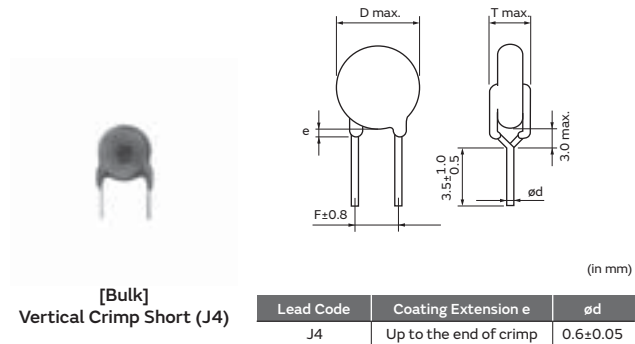
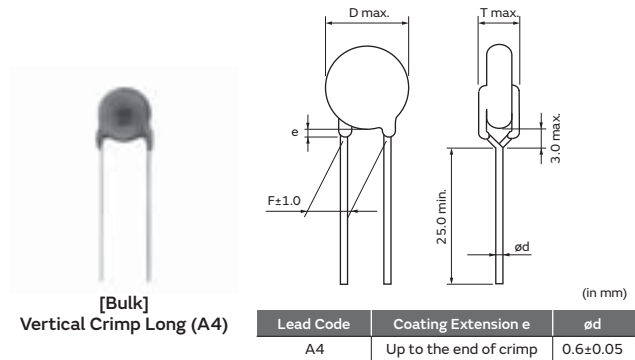

Marking

Example	Item
	① Type Designation RB
	② Nominal Capacitance (Under 100pF: Actual value, 100pF and over: 3 digit system)
	③ Capacitance Tolerance
	④ Company Name Code M15: Made in Thailand
	⑤ Manufactured Date Code Class Code X1Y1 Rated Voltage Mark 760~,500~

Rated Voltage X1: 760Vac

Part Number	AC Rated Voltage	Temp. Char.	Capacitance	Body Dia. D	Lead Spacing F (mm)	Body Thickness T	Lead Package Long Bulk	Lead Package Short Bulk	Lead Package Taping
DE11XRB100K□□□R01F	X1: 760Vac(r.m.s.), Y1: 500Vac(r.m.s.)	SL	10pF±10%	8.0mm max.	10.0	5.0mm max.	A4B	J4B	N4A
DE11XRB150K□□□R01F	X1: 760Vac(r.m.s.), Y1: 500Vac(r.m.s.)	SL	15pF±10%	6.0mm max.	10.0	6.0mm max.	A4B	J4B	N4A
DE11XRB220K□□□R01F	X1: 760Vac(r.m.s.), Y1: 500Vac(r.m.s.)	SL	22pF±10%	6.0mm max.	10.0	5.0mm max.	A4B	J4B	N4A
DE11XRB330K□□□R01F	X1: 760Vac(r.m.s.), Y1: 500Vac(r.m.s.)	SL	33pF±10%	7.0mm max.	10.0	5.0mm max.	A4B	J4B	N4A
DE11XRB470K□□□R01F	X1: 760Vac(r.m.s.), Y1: 500Vac(r.m.s.)	SL	47pF±10%	8.0mm max.	10.0	5.0mm max.	A4B	J4B	N4A
DE11XRB680K□□□R01F	X1: 760Vac(r.m.s.), Y1: 500Vac(r.m.s.)	SL	68pF±10%	9.0mm max.	10.0	5.0mm max.	A4B	J4B	N4A
DE1B3RB101K□□□R01F	X1: 760Vac(r.m.s.), Y1: 500Vac(r.m.s.)	B	100pF±10%	6.0mm max.	10.0	5.0mm max.	A4B	J4B	N4A
DE1B3RB151K□□□R01F	X1: 760Vac(r.m.s.), Y1: 500Vac(r.m.s.)	B	150pF±10%	8.0mm max.	10.0	5.0mm max.	A4B	J4B	N4A
DE1B3RB221K□□□R01F	X1: 760Vac(r.m.s.), Y1: 500Vac(r.m.s.)	B	220pF±10%	6.0mm max.	10.0	6.0mm max.	A4B	J4B	N4A
DE1B3RB331K□□□R01F	X1: 760Vac(r.m.s.), Y1: 500Vac(r.m.s.)	B	330pF±10%	7.0mm max.	10.0	6.0mm max.	A4B	J4B	N4A
DE1B3RB471K□□□R01F	X1: 760Vac(r.m.s.), Y1: 500Vac(r.m.s.)	B	470pF±10%	8.0mm max.	10.0	6.0mm max.	A4B	J4B	N4A
DE1B3RB681K□□□R01F	X1: 760Vac(r.m.s.), Y1: 500Vac(r.m.s.)	B	680pF±10%	9.0mm max.	10.0	6.0mm max.	A4B	J4B	N4A
DE1E3RB102M□□□R01F	X1: 760Vac(r.m.s.), Y1: 500Vac(r.m.s.)	E	1000pF±20%	8.0mm max.	10.0	6.0mm max.	A4B	J4B	N4A
DE1E3RB152M□□□R01F	X1: 760Vac(r.m.s.), Y1: 500Vac(r.m.s.)	E	1500pF±20%	9.0mm max.	10.0	6.0mm max.	A4B	J4B	N4A
DE1E3RB222M□□□R01F	X1: 760Vac(r.m.s.), Y1: 500Vac(r.m.s.)	E	2200pF±20%	11.0mm max.	10.0	6.0mm max.	A4B	J4B	N4A
DE1E3RB332M□□□R01F	X1: 760Vac(r.m.s.), Y1: 500Vac(r.m.s.)	E	3300pF±20%	13.0mm max.	10.0	6.0mm max.	A4B	J4B	N4A
DE1E3RB472M□□□R01F	X1: 760Vac(r.m.s.), Y1: 500Vac(r.m.s.)	E	4700pF±20%	14.0mm max.	10.0	6.0mm max.	A4B	J4B	N4A

Three blank columns are filled with the lead and packaging codes. Please refer to the 3 columns on the right for the appropriate codes.

Murata part numbers might be changed depending on lead code or any other changes. Therefore, please specify only the type name (RB) and capacitance of products in the part list when it is required for applying safety standard of electric equipments.

Type RB: X1: AC760V Specifications and Test Methods

Operating Temperature Range: -40 to +125°C

No.	Item	Specifications	Test Method																		
1	Appearance and Dimensions	No visible defect, and dimensions are within specified range.	The capacitor should be visually inspected for evidence of defect. Dimensions should be measured with slide calipers.																		
2	Marking	To be easily legible	The capacitor should be visually inspected.																		
3	Capacitance	Within specified tolerance	The capacitance, dissipation factor should be measured at 20°C with 1±0.1kHz and AC1±0.2V max.																		
4	Dissipation Factor (D.F.)	2.5% max.																			
5	Insulation Resistance (I.R.)	10000MΩ min.	The insulation resistance should be measured with DC500±50V within 60±5s of charging. The voltage should be applied to the capacitor through a resistor of 1MΩ.																		
6	Between Lead Wires	No failure	The capacitor should not be damaged when AC4000V (r.m.s.) <50/60Hz> is applied between the lead wires for 60s. First, the terminals of the capacitor should be connected together. Then, as shown in the figure at right, a metal foil should be closely wrapped around the body of the capacitor to the distance of about 3 to 6mm from each terminal. Then, the capacitor should be inserted into a container filled with metal balls of about 1mm diameter. Finally, AC4000V (r.m.s.) <50/60Hz> is applied for 60s between the capacitor lead wires and metal balls.																		
	Dielectric Strength	No failure																			
7	Temperature Characteristics	<table border="1"> <thead> <tr> <th>Char.</th> <th>Capacitance Change</th> </tr> </thead> <tbody> <tr> <td>B</td> <td>Within ±10%</td> </tr> <tr> <td>E</td> <td>Within ±$\frac{20}{55}$%</td> </tr> </tbody> </table> (Temp. range: -25 to +85°C)	Char.	Capacitance Change	B	Within ±10%	E	Within ± $\frac{20}{55}$ %	The capacitance measurement should be made at each step specified in Table 1. <Table 1> <table border="1"> <thead> <tr> <th>Step</th> <th>Temperature (°C)</th> </tr> </thead> <tbody> <tr> <td>1</td> <td>20±2</td> </tr> <tr> <td>2</td> <td>-25±2</td> </tr> <tr> <td>3</td> <td>20±2</td> </tr> <tr> <td>4</td> <td>85±2</td> </tr> <tr> <td>5</td> <td>20±2</td> </tr> </tbody> </table>	Step	Temperature (°C)	1	20±2	2	-25±2	3	20±2	4	85±2	5	20±2
		Char.	Capacitance Change																		
B	Within ±10%																				
E	Within ± $\frac{20}{55}$ %																				
Step	Temperature (°C)																				
1	20±2																				
2	-25±2																				
3	20±2																				
4	85±2																				
5	20±2																				
		<table border="1"> <thead> <tr> <th>Char.</th> <th>Temperature Coefficient</th> </tr> </thead> <tbody> <tr> <td>SL</td> <td>+350 to -1000ppm/°C</td> </tr> </tbody> </table> (Temp. range: +20 to +85°C)	Char.	Temperature Coefficient	SL	+350 to -1000ppm/°C															
Char.	Temperature Coefficient																				
SL	+350 to -1000ppm/°C																				
8	Solderability of Leads	Lead wire should be soldered with uniform coating on the axial direction over 3/4 of the circumferential direction.	The lead wire of a capacitor should be dipped into molten solder for 2±0.5s. The depth of immersion is up to about 1.5 to 2.0mm from the root of lead wires. Temp. of solder: Lead Free Solder (Sn-3Ag-0.5Cu) 245±5°C																		
9	Appearance	No marked defect	Solder Temperature : 350±10°C or 260±5°C Immersion time : 3.5±0.5s (In case of 260±5°C : 10±1s) The depth of immersion is up to about 1.5 to 2.0mm from the roof of lead wires.																		
	Capacitance Change	Within ±10%																			
	I.R.	1000MΩ min.																			
	Dielectric Strength	Per Item 6																			
Soldering Effect (Non-Preheat)			Pre-treatment: Capacitor should be stored at 125±2°C for 1h, and apply the AC4000V(r.m.s.) 60s then placed at room condition* for 24±2h before initial measurements. (Do not apply to SL char.) Post-treatment: Capacitor should be stored for 1 to 2h at room condition*.																		

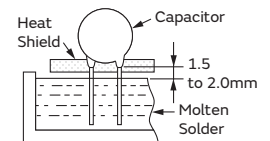
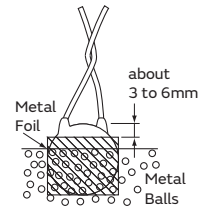

* "Room condition" Temperature: 15 to 35°C, Relative humidity: 45 to 75%, Atmosphere pressure: 86 to 106kPa

Continued on the following page. ↗

Type RB: X1: AC760V Specifications and Test Methods

Continued from the preceding page. ↘

No.	Item	Specifications	Test Method								
10	Soldering Effect (On-Preheat)	Appearance	No marked defect								
		Capacitance Change	Within $\pm 10\%$								
		I.R.	1000M Ω min.								
		Dielectric Strength	Per Item 6								
11	Vibration Resistance	Appearance	No marked defect								
		Capacitance	Within the specified tolerance								
		D.F.	2.5% max.								
12	Humidity (Under Steady State)	Appearance	No marked defect								
		Capacitance Change	<table border="1"> <thead> <tr> <th>Char.</th> <th>Capacitance Change</th> </tr> </thead> <tbody> <tr> <td>B</td> <td>Within $\pm 10\%$</td> </tr> <tr> <td>E</td> <td>Within $\pm 15\%$</td> </tr> <tr> <td>SL</td> <td>Within $\pm 5\%$</td> </tr> </tbody> </table>	Char.	Capacitance Change	B	Within $\pm 10\%$	E	Within $\pm 15\%$	SL	Within $\pm 5\%$
		Char.	Capacitance Change								
		B	Within $\pm 10\%$								
		E	Within $\pm 15\%$								
SL	Within $\pm 5\%$										
D.F.	<table border="1"> <thead> <tr> <th>Char.</th> <th>Specifications</th> </tr> </thead> <tbody> <tr> <td>B, E</td> <td>D.F. $\leq 5.0\%$</td> </tr> <tr> <td>SL</td> <td>D.F. $\leq 2.5\%$</td> </tr> </tbody> </table>	Char.	Specifications	B, E	D.F. $\leq 5.0\%$	SL	D.F. $\leq 2.5\%$				
Char.	Specifications										
B, E	D.F. $\leq 5.0\%$										
SL	D.F. $\leq 2.5\%$										
I.R.	3000M Ω min.										
Dielectric Strength	Per Item 6										
13	Humidity Loading	Appearance	No marked defect								
		Capacitance Change	<table border="1"> <thead> <tr> <th>Char.</th> <th>Capacitance Change</th> </tr> </thead> <tbody> <tr> <td>B</td> <td>Within $\pm 10\%$</td> </tr> <tr> <td>E</td> <td>Within $\pm 15\%$</td> </tr> <tr> <td>SL</td> <td>Within $\pm 5\%$</td> </tr> </tbody> </table>	Char.	Capacitance Change	B	Within $\pm 10\%$	E	Within $\pm 15\%$	SL	Within $\pm 5\%$
		Char.	Capacitance Change								
		B	Within $\pm 10\%$								
		E	Within $\pm 15\%$								
SL	Within $\pm 5\%$										
D.F.	<table border="1"> <thead> <tr> <th>Char.</th> <th>Specifications</th> </tr> </thead> <tbody> <tr> <td>B, E</td> <td>D.F. $\leq 5.0\%$</td> </tr> <tr> <td>SL</td> <td>D.F. $\leq 2.5\%$</td> </tr> </tbody> </table>	Char.	Specifications	B, E	D.F. $\leq 5.0\%$	SL	D.F. $\leq 2.5\%$				
Char.	Specifications										
B, E	D.F. $\leq 5.0\%$										
SL	D.F. $\leq 2.5\%$										
I.R.	3000M Ω min.										
Dielectric Strength	Per Item 6										

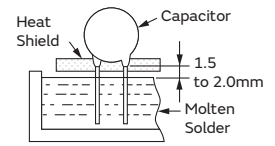

First the capacitor should be stored at $120+0/-5^{\circ}\text{C}$ for $60+0/-5\text{s}$. Then, as in the figure, the lead wires should be immersed in solder of $260+0/-5^{\circ}\text{C}$ up to 1.5 to 2.0mm from the root of terminal for $7.5+0/-1\text{s}$.
 Pre-treatment:
 Capacitor should be stored at $125\pm 2^{\circ}\text{C}$ for 1h, and apply the AC4000V(r.m.s.) 60s then placed at room condition* for $24\pm 2\text{h}$ before initial measurements. (Do not apply to SL char.)
 Post-treatment:
 Capacitor should be stored for 1 to 2h at room condition*.

The capacitor should be firmly soldered to the supporting lead wire and vibrated at a frequency range of 10 to 55Hz, 1.5mm in total amplitude, with about a 1-minute rate of vibration change from 10 to 55Hz and back to 10Hz. Apply for a total of 6h, 2h each in 3 mutually perpendicular directions.

Set the capacitor for $500\pm 12\text{h}$ at $40\pm 2^{\circ}\text{C}$ in 90 to 95% relative humidity.
 Pre-treatment:
 Capacitor should be stored at $125\pm 2^{\circ}\text{C}$ for 1h, and apply the AC4000V(r.m.s.) 60s then placed at room condition* for $24\pm 2\text{h}$ before initial measurements. (Do not apply to SL char.)
 Post-treatment:
 Capacitor should be stored for 1 to 2h at room condition*.

Apply the AC760V (r.m.s.) for $500\pm 12\text{h}$ at $40\pm 2^{\circ}\text{C}$ in 90 to 95% relative humidity.
 Pre-treatment:
 Capacitor should be stored at $125\pm 2^{\circ}\text{C}$ for 1h, and apply the AC4000V(r.m.s.) 60s then placed at room condition* for $24\pm 2\text{h}$ before initial measurements. (Do not apply to SL char.)
 Post-treatment:
 Capacitor should be stored for 1 to 2h at room condition*.

* "Room condition" Temperature: 15 to 35°C , Relative humidity: 45 to 75%, Atmosphere pressure: 86 to 106kPa

Continued on the following page. ↗

Type RB: X1: AC760V Specifications and Test Methods

Continued from the preceding page. ↘

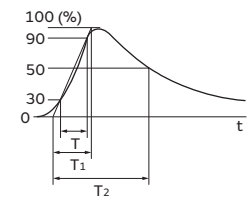
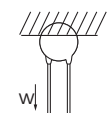
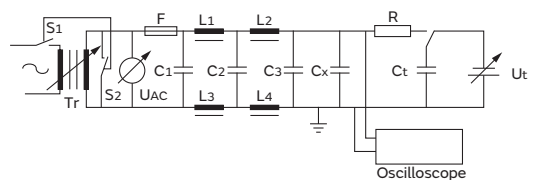
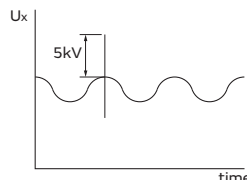
No.	Item	Specifications	Test Method
14	Appearance	No marked defect	Impulse Voltage 12kV impulses for three times. Then the capacitors are applied to life test.
	Capacitance Change	Within ±20%	
14	I.R.	3000MΩ min.	 <p style="text-align: right;">Front time (T1) = 1.2μs = 1.67T Time to half-value (T2) = 50μs</p>
	Dielectric Strength	Per Item 6	
14	Life		Apply a voltage from Table 2 for 1000h at 125±2/-0°C, and relative humidity of 50% max. <div style="text-align: center;"> <Table 2> Applied voltage AC950V(r.m.s.) <50/60Hz> except that once each hour the voltage is increased to AC1000V(r.m.s.) for 0.1 sec. </div> Pre-treatment: Capacitor should be stored at 125±2°C for 1h, and apply the AC4000V(r.m.s.) 60s then placed at room condition* for 24±2h before initial measurements. (Do not apply to SL char.) Post-treatment: Capacitor should be stored for 24h at room condition*.
15	Tensile	Lead wire should not be cut off. Capacitor should not be broken.	As shown in the figure at right, fix the body of the capacitor and apply a tensile weight gradually to each lead wire in the radial direction of the capacitor up to 10N and keep it for 10±1s. 
	Bending		Each lead wire should be subjected to 5N of weight and bent 90° at the point of egress, in one direction, then returned to its original position and bent 90° in the opposite direction at the rate of one bend in 2 to 3s.
16	Active Flammability	The cheesecloth should not be on fire.	The capacitor should be individually wrapped in at least one but not more than two complete layers of cheesecloth. The capacitor should be subjected to 20 discharges. The interval between successive discharges should be 5s. The UAC should be maintained for 2min after the last discharge.  <p style="margin-top: 10px;"> C1,2 : 1μF±10% C3 : 0.033μF±5% 10kV L1 to 4 : 1.5mH±20% 16A Rod core choke Ct : 3μF±5% 10kV R : 100Ω±2% Cx : Capacitor under test UAC : UR±5% F : Fuse, Rated 10A UR : Rated Voltage Ut : Voltage applied to Ct </p> 

* "Room condition" Temperature: 15 to 35°C, Relative humidity: 45 to 75%, Atmosphere pressure: 86 to 106kPa

Continued on the following page. ↗

Type RB: X1: AC760V Specifications and Test Methods

Continued from the preceding page. ↘

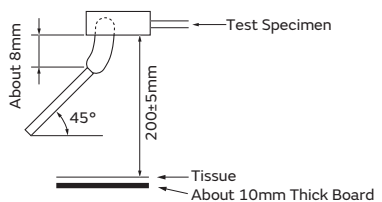
No.	Item	Specifications	Test Method																																									
17	Passive Flammability	The burning time should not exceed 30s. The tissue paper should not ignite.	<p>The capacitor under test should be held in the flame in the position that best promotes burning. Each specimen should only be exposed once to the flame. Time of exposure to flame: 30s.</p> <p style="margin-left: 20px;">Length of flame : 12±1mm Gas burner : Length 35mm min. : Inside Dia. 0.5±0.1mm : Outside Dia. 0.9mm max. Gas : Butane gas Purity 95% min.</p> 																																									
18	Temperature and Immersion Cycle	<p>Appearance : No marked defect</p> <table border="1" style="width: 100%; border-collapse: collapse; margin-bottom: 5px;"> <thead> <tr style="background-color: #444; color: white;"> <th style="width: 15%;">Char.</th> <th style="width: 85%;">Capacitance Change</th> </tr> </thead> <tbody> <tr> <td style="text-align: center;">B</td> <td style="text-align: center;">Within ±10%</td> </tr> <tr> <td style="text-align: center;">E</td> <td style="text-align: center;">Within ±20%</td> </tr> <tr> <td style="text-align: center;">SL</td> <td style="text-align: center;">Within ± 5%</td> </tr> </tbody> </table> <table border="1" style="width: 100%; border-collapse: collapse; margin-bottom: 5px;"> <thead> <tr style="background-color: #444; color: white;"> <th style="width: 15%;">Char.</th> <th style="width: 85%;">Specifications</th> </tr> </thead> <tbody> <tr> <td style="text-align: center;">B, E</td> <td style="text-align: center;">D.F. ≤5.0%</td> </tr> <tr> <td style="text-align: center;">SL</td> <td style="text-align: center;">D.F. ≤2.5%</td> </tr> </tbody> </table> <p>I.R. : 3000MΩ min.</p> <p>Dielectric Strength : Per Item 6</p>	Char.	Capacitance Change	B	Within ±10%	E	Within ±20%	SL	Within ± 5%	Char.	Specifications	B, E	D.F. ≤5.0%	SL	D.F. ≤2.5%	<p>The capacitor should be subjected to 5 temperature cycles, then consecutively to 2 immersion cycles.</p> <p style="text-align: center;"><Temperature Cycle></p> <table border="1" style="width: 100%; border-collapse: collapse; margin-bottom: 10px;"> <thead> <tr style="background-color: #444; color: white;"> <th style="width: 10%;">Step</th> <th style="width: 60%;">Temperature (°C)</th> <th style="width: 30%;">Time (min.)</th> </tr> </thead> <tbody> <tr> <td style="text-align: center;">1</td> <td style="text-align: center;">-40+0/-3</td> <td style="text-align: center;">30</td> </tr> <tr> <td style="text-align: center;">2</td> <td style="text-align: center;">Room temp.</td> <td style="text-align: center;">3</td> </tr> <tr> <td style="text-align: center;">3</td> <td style="text-align: center;">125+3/-0</td> <td style="text-align: center;">30</td> </tr> <tr> <td style="text-align: center;">4</td> <td style="text-align: center;">Room temp.</td> <td style="text-align: center;">3</td> </tr> </tbody> </table> <p style="text-align: right;">Cycle time: 500 cycles</p> <p style="text-align: center;"><Immersion Cycle></p> <table border="1" style="width: 100%; border-collapse: collapse; margin-bottom: 10px;"> <thead> <tr style="background-color: #444; color: white;"> <th style="width: 10%;">Step</th> <th style="width: 40%;">Temperature (°C)</th> <th style="width: 15%;">Time (min.)</th> <th style="width: 35%;">Immersion Water</th> </tr> </thead> <tbody> <tr> <td style="text-align: center;">1</td> <td style="text-align: center;">65+5/-0</td> <td style="text-align: center;">15</td> <td style="text-align: center;">Clean water</td> </tr> <tr> <td style="text-align: center;">2</td> <td style="text-align: center;">0±3</td> <td style="text-align: center;">15</td> <td style="text-align: center;">Salt water</td> </tr> </tbody> </table> <p style="text-align: right;">Cycle time: 2 cycles</p> <p>Pre-treatment: Capacitor should be stored at 125±2°C for 1h, and apply the AC400V(r.m.s.) 60s then placed at room condition* for 24±2h. (Do not apply to SL char.)</p> <p>Post-treatment: Capacitor should be stored for 24±2h at room condition*.</p>	Step	Temperature (°C)	Time (min.)	1	-40+0/-3	30	2	Room temp.	3	3	125+3/-0	30	4	Room temp.	3	Step	Temperature (°C)	Time (min.)	Immersion Water	1	65+5/-0	15	Clean water	2	0±3	15	Salt water
Char.	Capacitance Change																																											
B	Within ±10%																																											
E	Within ±20%																																											
SL	Within ± 5%																																											
Char.	Specifications																																											
B, E	D.F. ≤5.0%																																											
SL	D.F. ≤2.5%																																											
Step	Temperature (°C)	Time (min.)																																										
1	-40+0/-3	30																																										
2	Room temp.	3																																										
3	125+3/-0	30																																										
4	Room temp.	3																																										
Step	Temperature (°C)	Time (min.)	Immersion Water																																									
1	65+5/-0	15	Clean water																																									
2	0±3	15	Salt water																																									

* "Room condition" Temperature: 15 to 35°C, Relative humidity: 45 to 75%, Atmosphere pressure: 86 to 106kPa

Safety Standard Certified Lead Type Disc Ceramic Capacitors for General Purpose

Type KY (Basic Insulation) -Class X1, Y2-

Features

1. Compact size; diameter 25% less than Type KH.
2. Operating temperature range guaranteed up to 125°C.
3. Dielectric strength:
 AC2000V (for lead spacing F=5mm)
 AC2600V (for lead spacing F=7.5mm)
4. Class X1/Y2 capacitors certified by UL/CSA/VDE/BSI/SEMKO/DEMKO/FIMKO/NEMKO/ESTI/NSW/CQC.
5. Coated with flame-retardant halogen-free* epoxy resin (conforming to UL94V-0 standard).
 * Cl=900ppm max., Br=900ppm max. and Cl+Br=1500ppm max.
6. Taping available for automatic insertion.
7. Rated Voltage: X1: AC250V(r.m.s.), Y2: AC250V(r.m.s.) or X1: AC250V(r.m.s.), Y2: AC300V(r.m.s.)

Applications

Ideal for use as X/Y capacitors for AC line filters and primary-secondary coupling on switching power supplies and AC adapters.

Do not use these products in any automotive power train or safety equipment including battery chargers for electric vehicles and plug-in hybrids. Only Murata products clearly stipulated as "for Automotive use" on its catalog can be used for automobile applications such as power train and safety equipment.

Standard Certification

	Standard No.	Certified No.	Rated Voltage
UL	UL60384-14	E37921	250Vac(r.m.s.)
CSA	CSA E60384-14	1283280	
VDE	IEC 60384-14 EN 60384-14	40006273	
BSI	EN 60065 (8.8, 14.2)	KM 37901	
	IEC 60384-14 EN 60384-14		
SEMKO	IEC 60384-14 EN 60384-14	1612608	
DEMKO		D-05317	
FIMKO		FI29603	
NEMKO		P16221234	
ESTI		18.0080	
NSW	IEC 60384-14 AS3250	6824	
CQC	GB/T6346.14	CQC06001017447	

- The certification number might change due to revision of the application standard and changes in the range of acquisition.
- Please contact us when the certification of South Korean Safety Standard is necessary.

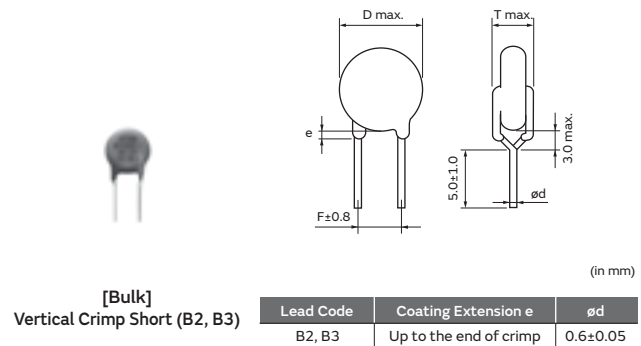
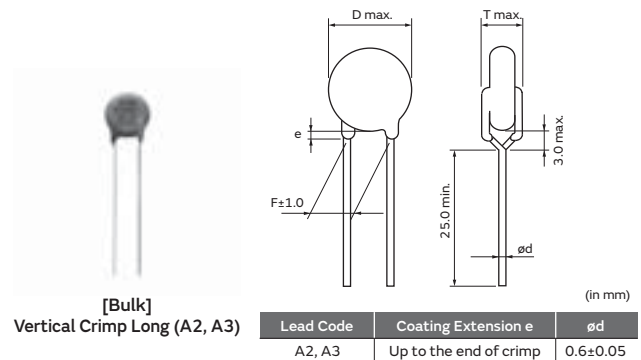

	Standard No.	Certified No.	Rated Voltage
UL	UL60384-14	E37921	300Vac(r.m.s.)
CSA	CSA E60384-14	1283280	
VDE	IEC 60384-14 EN 60384-14	40006273	
BSI	EN 60065 (8.8, 14.2)	KM 37901	
	IEC 60384-14 EN 60384-14		
SEMKO	IEC 60384-14 EN 60384-14	1612608	
DEMKO		D-05317	
FIMKO		FI29603	
NEMKO		P16221234	
ESTI		18.0080	
NSW	IEC 60384-14 AS3250	6824	
CQC	IEC 60384-14	CQC12001079940	

- The certification number might change due to revision of the application standard and changes in the range of acquisition.

Continued on the following page. ↗

Continued from the preceding page. ↘

Marking

Example	Item
	① Type Designation KY
	② Nominal Capacitance (Under 100pF: Actual value, 100pF and over: 3 digit system)
	③ Capacitance Tolerance
	④ Company Name Code ©15: Made in Thailand
	⑤ Manufactured Date Code
	Class Code X1Y2
	Rated Voltage Mark 250~, 300~
	Halogen Free Mark HF

Rated Voltage 250Vac

Lead Spacing F=7.5mm

Part Number	AC Rated Voltage	Temp. Char.	Capacitance	Body Dia. D	Lead Spacing F (mm)	Body Thickness T	Lead Package Long Bulk	Lead Package Short Bulk	Lead Package Taping
DE21XKY100J□□□M02F	250Vac(r.m.s.)	SL	10pF±5%	8.0mm max.	7.5	5.0mm max.	A3B	B3B	N3A
DE21XKY150J□□□M02F	250Vac(r.m.s.)	SL	15pF±5%	8.0mm max.	7.5	5.0mm max.	A3B	B3B	N3A
DE21XKY220J□□□M02F	250Vac(r.m.s.)	SL	22pF±5%	8.0mm max.	7.5	5.0mm max.	A3B	B3B	N3A
DE21XKY330J□□□M02F	250Vac(r.m.s.)	SL	33pF±5%	8.0mm max.	7.5	5.0mm max.	A3B	B3B	N3A
DE21XKY470J□□□M02F	250Vac(r.m.s.)	SL	47pF±5%	8.0mm max.	7.5	5.0mm max.	A3B	B3B	N3A
DE21XKY680J□□□M02F	250Vac(r.m.s.)	SL	68pF±5%	8.0mm max.	7.5	5.0mm max.	A3B	B3B	N3A
DE2B3KY101K□□□M02F	250Vac(r.m.s.)	B	100pF±10%	7.0mm max.	7.5	5.0mm max.	A3B	B3B	N3A
DE2B3KY151K□□□M02F	250Vac(r.m.s.)	B	150pF±10%	7.0mm max.	7.5	5.0mm max.	A3B	B3B	N3A
DE2B3KY221K□□□M02F	250Vac(r.m.s.)	B	220pF±10%	7.0mm max.	7.5	5.0mm max.	A3B	B3B	N3A
DE2B3KY331K□□□M02F	250Vac(r.m.s.)	B	330pF±10%	7.0mm max.	7.5	5.0mm max.	A3B	B3B	N3A
DE2B3KY471K□□□M02F	250Vac(r.m.s.)	B	470pF±10%	7.0mm max.	7.5	5.0mm max.	A3B	B3B	N3A
DE2B3KY681K□□□M02F	250Vac(r.m.s.)	B	680pF±10%	8.0mm max.	7.5	5.0mm max.	A3B	B3B	N3A
DE2E3KY102M□□□M02F	250Vac(r.m.s.)	E	1000pF±20%	7.0mm max.	7.5	5.0mm max.	A3B	B3B	N3A
DE2E3KY152M□□□M02F	250Vac(r.m.s.)	E	1500pF±20%	7.0mm max.	7.5	5.0mm max.	A3B	B3B	N3A
DE2E3KY222M□□□M02F	250Vac(r.m.s.)	E	2200pF±20%	8.0mm max.	7.5	5.0mm max.	A3B	B3B	N3A
DE2E3KY332M□□□M02F	250Vac(r.m.s.)	E	3300pF±20%	9.0mm max.	7.5	5.0mm max.	A3B	B3B	N3A
DE2E3KY472M□□□M02F	250Vac(r.m.s.)	E	4700pF±20%	10.0mm max.	7.5	5.0mm max.	A3B	B3B	N3A
DE2F3KY103M□□□M02F	250Vac(r.m.s.)	F	10000pF±20%	14.0mm max.	7.5	5.0mm max.	A3B	B3B	N3A

Three blank columns are filled with the lead and packaging codes. Please refer to the 3 columns on the right for the appropriate code.

Individual specification code "M02" expresses "simplicity marking and guarantee of dielectric strength between lead wires: AC2600V."

Murata part numbers might be changed depending on lead code or any other changes. Therefore, please specify only the type name (KY) and capacitance of products in the parts list when it is required for applying safety standard of electric equipment.

Continued on the following page. ↗

Continued from the preceding page. ↘

Lead Spacing F=5mm

Part Number	AC Rated Voltage	Temp. Char.	Capacitance	Body Dia. D	Lead Spacing F (mm)	Body Thickness T	Lead Package Long Bulk	Lead Package Short Bulk	Lead Package Taping
DE21XKY100J□□□M01F	250Vac(r.m.s.)	SL	10pF±5%	8.0mm max.	5.0	5.0mm max.	A2B	B2B	N2A
DE21XKY150J□□□M01F	250Vac(r.m.s.)	SL	15pF±5%	8.0mm max.	5.0	5.0mm max.	A2B	B2B	N2A
DE21XKY220J□□□M01F	250Vac(r.m.s.)	SL	22pF±5%	8.0mm max.	5.0	5.0mm max.	A2B	B2B	N2A
DE21XKY330J□□□M01F	250Vac(r.m.s.)	SL	33pF±5%	8.0mm max.	5.0	5.0mm max.	A2B	B2B	N2A
DE21XKY470J□□□M01F	250Vac(r.m.s.)	SL	47pF±5%	8.0mm max.	5.0	5.0mm max.	A2B	B2B	N2A
DE21XKY680J□□□M01F	250Vac(r.m.s.)	SL	68pF±5%	8.0mm max.	5.0	5.0mm max.	A2B	B2B	N2A
DE2B3KY101K□□□M01F	250Vac(r.m.s.)	B	100pF±10%	7.0mm max.	5.0	5.0mm max.	A2B	B2B	N2A
DE2B3KY151K□□□M01F	250Vac(r.m.s.)	B	150pF±10%	7.0mm max.	5.0	5.0mm max.	A2B	B2B	N2A
DE2B3KY221K□□□M01F	250Vac(r.m.s.)	B	220pF±10%	7.0mm max.	5.0	5.0mm max.	A2B	B2B	N2A
DE2B3KY331K□□□M01F	250Vac(r.m.s.)	B	330pF±10%	7.0mm max.	5.0	5.0mm max.	A2B	B2B	N2A
DE2B3KY471K□□□M01F	250Vac(r.m.s.)	B	470pF±10%	7.0mm max.	5.0	5.0mm max.	A2B	B2B	N2A
DE2B3KY681K□□□M01F	250Vac(r.m.s.)	B	680pF±10%	8.0mm max.	5.0	5.0mm max.	A2B	B2B	N2A
DE2E3KY102M□□□M01F	250Vac(r.m.s.)	E	1000pF±20%	7.0mm max.	5.0	5.0mm max.	A2B	B2B	N2A
DE2E3KY152M□□□M01F	250Vac(r.m.s.)	E	1500pF±20%	7.0mm max.	5.0	5.0mm max.	A2B	B2B	N2A
DE2E3KY222M□□□M01F	250Vac(r.m.s.)	E	2200pF±20%	8.0mm max.	5.0	5.0mm max.	A2B	B2B	N2A
DE2E3KY332M□□□M01F	250Vac(r.m.s.)	E	3300pF±20%	9.0mm max.	5.0	5.0mm max.	A2B	B2B	N2A
DE2E3KY472M□□□M01F	250Vac(r.m.s.)	E	4700pF±20%	10.0mm max.	5.0	5.0mm max.	A2B	B2B	N2A

Three blank columns are filled with the lead and packaging codes. Please refer to the 3 columns on the right for the appropriate code.
 Individual specification code "M01" expresses "simplicity marking and guarantee of dielectric strength between lead wires: AC2000V."
 Murata part numbers might be changed depending on lead code or any other changes. Therefore, please specify only the type name (KY) and capacitance of products in the parts list when it is required for applying safety standard of electric equipment.

Rated Voltage 300Vac

Lead Spacing F=7.5mm

Part Number	AC Rated Voltage	Temp. Char.	Capacitance	Body Dia. D	Lead Spacing F (mm)	Body Thickness T	Lead Package Long Bulk	Lead Package Short Bulk	Lead Package Taping
DE2B3KY101K□□□U02F	300Vac(r.m.s.)	B	100pF±10%	7.0mm max.	7.5	5.0mm max.	A3B	B3B	N3A
DE2B3KY151K□□□U02F	300Vac(r.m.s.)	B	150pF±10%	7.0mm max.	7.5	5.0mm max.	A3B	B3B	N3A
DE2B3KY221K□□□U02F	300Vac(r.m.s.)	B	220pF±10%	7.0mm max.	7.5	5.0mm max.	A3B	B3B	N3A
DE2B3KY331K□□□U02F	300Vac(r.m.s.)	B	330pF±10%	7.0mm max.	7.5	5.0mm max.	A3B	B3B	N3A
DE2B3KY471K□□□U02F	300Vac(r.m.s.)	B	470pF±10%	7.0mm max.	7.5	5.0mm max.	A3B	B3B	N3A
DE2B3KY681K□□□U02F	300Vac(r.m.s.)	B	680pF±10%	8.0mm max.	7.5	5.0mm max.	A3B	B3B	N3A
DE2E3KY102M□□□U02F	300Vac(r.m.s.)	E	1000pF±20%	7.0mm max.	7.5	5.0mm max.	A3B	B3B	N3A
DE2E3KY152M□□□U02F	300Vac(r.m.s.)	E	1500pF±20%	7.0mm max.	7.5	5.0mm max.	A3B	B3B	N3A
DE2E3KY222M□□□U02F	300Vac(r.m.s.)	E	2200pF±20%	8.0mm max.	7.5	5.0mm max.	A3B	B3B	N3A
DE2E3KY332M□□□U02F	300Vac(r.m.s.)	E	3300pF±20%	9.0mm max.	7.5	5.0mm max.	A3B	B3B	N3A
DE2E3KY472M□□□U02F	300Vac(r.m.s.)	E	4700pF±20%	10.0mm max.	7.5	5.0mm max.	A3B	B3B	N3A
DE2F3KY103M□□□U02F	300Vac(r.m.s.)	F	10000pF±20%	14.0mm max.	7.5	5.0mm max.	A3B	B3B	N3A

Three blank columns are filled with the lead and packaging codes. Please refer to the 3 columns on the right for the appropriate code.
 Individual specification code "U02" expresses "simplicity marking and guarantee of dielectric strength between lead wires: AC2600V."
 Murata part numbers might be changed depending on lead code or any other changes. Therefore, please specify only the type name (KY) and capacitance of products in the parts list when it is required for applying safety standard of electric equipment.



Safety Standard Certified Lead Type Disc Ceramic Capacitors for General Purpose

Type KX New Small Size (Reinforced Insulation) -Class X1, Y1-

Features

1. We design capacitors much more compact in size than current Type KX, having reduced the diameter by 20% max.
2. Operating temperature range guaranteed up to 125°C.
3. Dielectric strength: AC4000V
4. Class X1/Y1 capacitors certified by UL/CSA/VDE/BSI/SEMKO/DEMKO/FIMKO/NEMKO/ ESTI/IMQ/CQC.
5. Can be use with a component in appliances requiring reinforced insulation and double insulation based on UL1492, IEC60065 and IEC60950.
6. Coated with flame-retardant halogen-free* epoxy resin (conforming to UL94V-0 standard).
 * Cl=900ppm max., Br=900ppm max. and Cl+Br=1500ppm max.
7. Taping available for automatic insertion.
8. Rated Voltage: X1: AC440V(r.m.s.), Y1: AC250V(r.m.s.) or X1: AC440V(r.m.s.), Y1: AC300V(r.m.s.)

Applications

Ideal for use as X/Y capacitors for AC line filters and primary-secondary coupling on switching power supplies and AC adapters.

Do not use these products in any automotive power train or safety equipment including battery chargers for electric vehicles and plug-in hybrids. Only Murata products clearly stipulated as "for Automotive use" on its catalog can be used for automobile applications such as power train and safety equipment.

* Small sized Type KX differs from current Type KX in electrical characteristics, such as the voltage dependency, capacitance temperature dependency, and Dielectric strength. Therefore, before replacing current Type KX, please make a performance check by equipment. Please also refer to Notice (Rating) item 2, "Performance Check by Equipment," below.

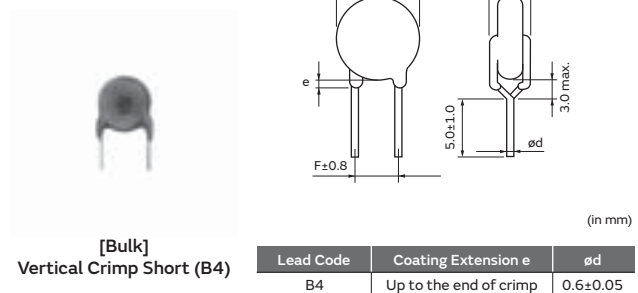
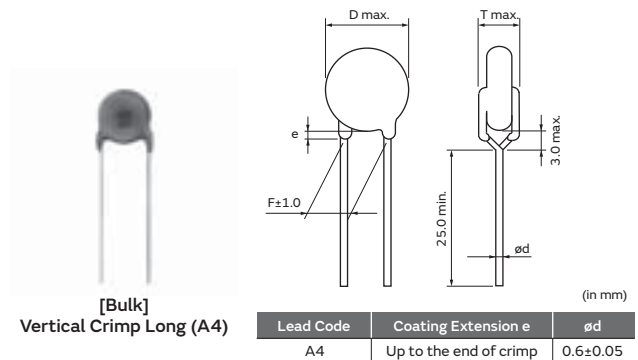

Standard Certification Rated Voltage (AC250V) B, E Char.

	Standard No.	Certified No.
UL	UL60384-14	E37921
CSA	CSA E60384-14	1343810
VDE	IEC 60384-14 EN 60384-14	40002831
BSI	EN 60065 (8.8, 14.2) IEC 60384-14 EN 60384-14	KM 37901
SEMKO		1612604
DEMKO		D-05321
FIMKO	IEC 60384-14	F129602
NEMKO	EN 60384-14	P16221232
ESTI		18.0079
IMQ	EN 60384-14	V4069
CQC	GB/T6346.14	CQC04001011643

- The certification number might change due to revision of the application standard and changes in the range of acquisition.
- Please contact us when the certification of South Korean Safety Standard is necessary.

Marking Rated Voltage (AC250V) B, E Char.

Example	Item
	① Type Designation KX
	② Nominal Capacitance (3 digit system)
	③ Capacitance Tolerance
	④ Company Name Code Ⓜ15: Made in Thailand
	⑤ Manufactured Date Code
	Class Code X1Y1
	Rated Voltage Mark 250~
	Halogen Free Mark HF

Standard Certification Rated Voltage (AC300V) B, E Char.

	Standard No.	Certified No.
UL	UL60384-14	E37921
CSA	CSA E60384-14	1343810
VDE	IEC 60384-14 EN 60384-14	40002831
BSI	EN 60065 (8.8, 14.2) IEC 60384-14 EN 60384-14	KM 37901
SEMKO		1612604
DEMKO		D-05321
FIMKO	IEC 60384-14	F129602
NEMKO	EN 60384-14	P16221232
ESTI		18.0079
IMQ	EN 60384-14	V4069
CQC	IEC 60384-14	CQC12001079941

- The certification number might change due to revision of the application standard and changes in the range of acquisition.

Marking Rated Voltage (AC300V) B, E Char.

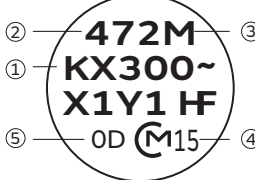
Example	Item
	① Type Designation KX
	② Nominal Capacitance (3 digit system)
	③ Capacitance Tolerance
	④ Company Name Code Ⓜ15: Made in Thailand
	⑤ Manufactured Date Code
	Class Code X1Y1
	Rated Voltage Mark 300~
	Halogen Free Mark HF

Rated Voltage 250Vac

Part Number	AC Rated Voltage	Temp. Char.	Capacitance	Body Dia. D	Lead Spacing F (mm)	Body Thickness T	Lead Package Long Bulk	Lead Package Short Bulk	Lead Package Taping
DE1B3KX101K□□□N01F	250Vac(r.m.s.)	B	100pF±10%	7.0mm max.	10.0	7.0mm max.	A4B	B4B	N4A
DE1B3KX151K□□□N01F	250Vac(r.m.s.)	B	150pF±10%	7.0mm max.	10.0	7.0mm max.	A4B	B4B	N4A
DE1B3KX221K□□□N01F	250Vac(r.m.s.)	B	220pF±10%	8.0mm max.	10.0	7.0mm max.	A4B	B4B	N4A
DE1B3KX331K□□□N01F	250Vac(r.m.s.)	B	330pF±10%	7.0mm max.	10.0	7.0mm max.	A4B	B4B	N4A
DE1B3KX471K□□□N01F	250Vac(r.m.s.)	B	470pF±10%	7.0mm max.	10.0	7.0mm max.	A4B	B4B	N4A
DE1B3KX681K□□□N01F	250Vac(r.m.s.)	B	680pF±10%	8.0mm max.	10.0	7.0mm max.	A4B	B4B	N4A
DE1E3KX102M□□□N01F	250Vac(r.m.s.)	E	1000pF±20%	7.0mm max.	10.0	7.0mm max.	A4B	B4B	N4A
DE1E3KX152M□□□N01F	250Vac(r.m.s.)	E	1500pF±20%	8.0mm max.	10.0	7.0mm max.	A4B	B4B	N4A
DE1E3KX222M□□□N01F	250Vac(r.m.s.)	E	2200pF±20%	9.0mm max.	10.0	7.0mm max.	A4B	B4B	N4A
DE1E3KX332M□□□N01F	250Vac(r.m.s.)	E	3300pF±20%	10.0mm max.	10.0	7.0mm max.	A4B	B4B	N4A
DE1E3KX472M□□□N01F	250Vac(r.m.s.)	E	4700pF±20%	12.0mm max.	10.0	7.0mm max.	A4B	B4B	N4A

Three blank columns are filled with the lead and packaging codes. Please refer to the 3 columns on the right for the appropriate code.
 Murata part numbers might be changed depending on lead code or any other changes. Therefore, please specify only the type name (KX) and capacitance of products in the parts list when it is required for applying safety standard of electric equipment.
 Please contact us when less than 100pF capacitance product is necessary.

Continued on the following page. ↗

Continued from the preceding page. ↘

Rated Voltage 300Vac

Part Number	AC Rated Voltage	Temp. Char.	Capacitance	Body Dia. D	Lead Spacing F (mm)	Body Thickness T	Lead Package Long Bulk	Lead Package Short Bulk	Lead Package Taping
DE1B3KX101K□□□P01F	300Vac(r.m.s.)	B	100pF±10%	7.0mm max.	10.0	7.0mm max.	A4B	B4B	N4A
DE1B3KX151K□□□P01F	300Vac(r.m.s.)	B	150pF±10%	7.0mm max.	10.0	7.0mm max.	A4B	B4B	N4A
DE1B3KX221K□□□P01F	300Vac(r.m.s.)	B	220pF±10%	8.0mm max.	10.0	7.0mm max.	A4B	B4B	N4A
DE1B3KX331K□□□P01F	300Vac(r.m.s.)	B	330pF±10%	7.0mm max.	10.0	7.0mm max.	A4B	B4B	N4A
DE1B3KX471K□□□P01F	300Vac(r.m.s.)	B	470pF±10%	7.0mm max.	10.0	7.0mm max.	A4B	B4B	N4A
DE1B3KX681K□□□P01F	300Vac(r.m.s.)	B	680pF±10%	8.0mm max.	10.0	7.0mm max.	A4B	B4B	N4A
DE1E3KX102M□□□P01F	300Vac(r.m.s.)	E	1000pF±20%	7.0mm max.	10.0	7.0mm max.	A4B	B4B	N4A
DE1E3KX152M□□□P01F	300Vac(r.m.s.)	E	1500pF±20%	8.0mm max.	10.0	7.0mm max.	A4B	B4B	N4A
DE1E3KX222M□□□P01F	300Vac(r.m.s.)	E	2200pF±20%	9.0mm max.	10.0	7.0mm max.	A4B	B4B	N4A
DE1E3KX332M□□□P01F	300Vac(r.m.s.)	E	3300pF±20%	10.0mm max.	10.0	7.0mm max.	A4B	B4B	N4A
DE1E3KX472M□□□P01F	300Vac(r.m.s.)	E	4700pF±20%	12.0mm max.	10.0	7.0mm max.	A4B	B4B	N4A

Three blank columns are filled with the lead and packaging codes. Please refer to the 3 columns on the right for the appropriate code. Murata part numbers might be changed depending on lead code or any other changes. Therefore, please specify only the type name (KX) and capacitance of products in the parts list when it is required for applying safety standard of electric equipment.

Type KY/KX Specifications and Test Methods

Operating Temperature Range: -40 to +125°C (Except for UL/VDE, -25 to +125°C)

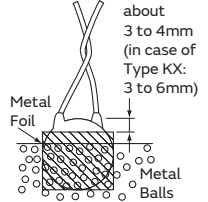
No.	Item	Specifications	Test Method																								
1	Appearance and Dimensions	No visible defect, and dimensions are within specified range.	The capacitor should be visually inspected for evidence of defect. Dimensions should be measured with slide calipers.																								
2	Marking	To be easily legible	The capacitor should be visually inspected.																								
3	Capacitance	Within specified tolerance	The capacitance, dissipation factor and Q should be measured at 20°C with 1±0.1kHz (char. SL: 1±0.1MHz) and AC5V(r.m.s.) max.																								
4	Dissipation Factor (D.F.) Q	<table border="1"> <thead> <tr> <th>Char.</th> <th>Specifications</th> </tr> </thead> <tbody> <tr> <td>B, E</td> <td>D.F. ≤2.5%</td> </tr> <tr> <td>F</td> <td>D.F. ≤5.0%</td> </tr> <tr> <td>SL</td> <td>Q ≥400+20C*(C<30pF) Q ≥1000 (C ≥30pF)</td> </tr> </tbody> </table>		Char.	Specifications	B, E	D.F. ≤2.5%	F	D.F. ≤5.0%	SL	Q ≥400+20C*(C<30pF) Q ≥1000 (C ≥30pF)																
Char.	Specifications																										
B, E	D.F. ≤2.5%																										
F	D.F. ≤5.0%																										
SL	Q ≥400+20C*(C<30pF) Q ≥1000 (C ≥30pF)																										
5	Insulation Resistance (I.R.)	10000MΩ min.	The insulation resistance should be measured with DC500±50V within 60±5s of charging. The voltage should be applied to the capacitor through a resistor of 1MΩ.																								
6	Between Lead Wires	No failure	<p>The capacitor should not be damaged when the test voltages from Table 1 are applied between the lead wires for 60s.</p> <p style="text-align: center;"><Table 1></p> <table border="1"> <thead> <tr> <th>Type</th> <th>Test Voltage</th> </tr> </thead> <tbody> <tr> <td>KY</td> <td>For lead spacing F=5mm AC2000V(r.m.s.) <50/60Hz> For lead spacing F=7.5mm AC2600V(r.m.s.) <50/60Hz></td> </tr> <tr> <td>KX</td> <td>AC4000V(r.m.s.) <50/60Hz></td> </tr> </tbody> </table>	Type	Test Voltage	KY	For lead spacing F=5mm AC2000V(r.m.s.) <50/60Hz> For lead spacing F=7.5mm AC2600V(r.m.s.) <50/60Hz>	KX	AC4000V(r.m.s.) <50/60Hz>																		
	Type	Test Voltage																									
KY	For lead spacing F=5mm AC2000V(r.m.s.) <50/60Hz> For lead spacing F=7.5mm AC2600V(r.m.s.) <50/60Hz>																										
KX	AC4000V(r.m.s.) <50/60Hz>																										
Body Insulation	No failure	<p>First, the terminals of the capacitor should be connected together. Then, as shown in the figure at right, a metal foil should be closely wrapped around the body of the capacitor to the distance of about 3 to 4mm (in case of Type KX: 3 to 6mm) from each terminal. Then, the capacitor should be inserted into a container filled with metal balls of about 1mm diameter. Finally, AC voltage from Table 2 is applied for 60s between the capacitor lead wires and metal balls.</p>  <p style="text-align: center;"><Table 2></p> <table border="1"> <thead> <tr> <th>Type</th> <th>Test Voltage</th> </tr> </thead> <tbody> <tr> <td>KY</td> <td>AC2600V(r.m.s.) <50/60Hz></td> </tr> <tr> <td>KX</td> <td>AC4000V(r.m.s.) <50/60Hz></td> </tr> </tbody> </table>	Type	Test Voltage	KY	AC2600V(r.m.s.) <50/60Hz>	KX	AC4000V(r.m.s.) <50/60Hz>																			
Type	Test Voltage																										
KY	AC2600V(r.m.s.) <50/60Hz>																										
KX	AC4000V(r.m.s.) <50/60Hz>																										
7	Temperature Characteristics	<table border="1"> <thead> <tr> <th>Char.</th> <th>Capacitance Change</th> </tr> </thead> <tbody> <tr> <td>B</td> <td>Within ±10%</td> </tr> <tr> <td>E</td> <td>Within ±20%</td> </tr> <tr> <td>F</td> <td>Within ±30%</td> </tr> </tbody> </table> <p>(Temp. range: -25 to +85°C)</p> <table border="1"> <thead> <tr> <th>Char.</th> <th>Temperature Coefficient</th> </tr> </thead> <tbody> <tr> <td>SL</td> <td>+350 to -1000ppm/°C</td> </tr> </tbody> </table> <p>(Temp. range: +20 to +85°C)</p>	Char.	Capacitance Change	B	Within ±10%	E	Within ±20%	F	Within ±30%	Char.	Temperature Coefficient	SL	+350 to -1000ppm/°C	<p>The capacitance measurement should be made at each step specified in Table 3.</p> <p style="text-align: center;"><Table 3></p> <table border="1"> <thead> <tr> <th>Step</th> <th>Temperature (°C)</th> </tr> </thead> <tbody> <tr> <td>1</td> <td>20±2</td> </tr> <tr> <td>2</td> <td>-25±2</td> </tr> <tr> <td>3</td> <td>20±2</td> </tr> <tr> <td>4</td> <td>85±2</td> </tr> <tr> <td>5</td> <td>20±2</td> </tr> </tbody> </table>	Step	Temperature (°C)	1	20±2	2	-25±2	3	20±2	4	85±2	5	20±2
Char.	Capacitance Change																										
B	Within ±10%																										
E	Within ±20%																										
F	Within ±30%																										
Char.	Temperature Coefficient																										
SL	+350 to -1000ppm/°C																										
Step	Temperature (°C)																										
1	20±2																										
2	-25±2																										
3	20±2																										
4	85±2																										
5	20±2																										
8	Solderability of Leads	Lead wire should be soldered with uniform coating on the axial direction over 3/4 of the circumferential direction.	<p>The lead wire of a capacitor should be dipped into molten solder for 2±0.5s. The depth of immersion is up to about 1.5 to 2.0mm from the root of lead wires. Temp. of solder: Lead Free Solder (Sn-3Ag-0.5Cu) 245±5°C H63 Eutectic Solder 235±5°C</p>																								

* "C" expresses nominal capacitance value (pF).

Continued on the following page. ↗

Type KY/KX Specifications and Test Methods

Continued from the preceding page. ↘

No.	Item	Specifications	Test Method								
9	Appearance	No marked defect	As shown in the figure, the lead wires should be immersed in solder of $350\pm 10^{\circ}\text{C}$ or $260\pm 5^{\circ}\text{C}$ up to 1.5 to 2.0mm from the root of terminal for 3.5±0.5s (10±1s for $260\pm 5^{\circ}\text{C}$). Pre-treatment: Capacitor should be stored at $85\pm 2^{\circ}\text{C}$ for 1h, then placed at room condition* ² for 24±2h before initial measurements. Post-treatment: Capacitor should be stored for 1 to 2h at room condition* ² .								
	Capacitance Change	Within ±10%									
	I.R.	1000MΩ min.									
	Dielectric Strength	Per Item 6									
10	Appearance	No marked defect	First the capacitor should be stored at $120+0/-5^{\circ}\text{C}$ for 60+0/-5s. Then, as in the figure, the lead wires should be immersed in solder of $260+0/-5^{\circ}\text{C}$ up to 1.5 to 2.0mm from the root of terminal for 7.5+0/-1s. Pre-treatment: Capacitor should be stored at $85\pm 2^{\circ}\text{C}$ for 1h, then placed at room condition* ² for 24±2h before initial measurements. Post-treatment: Capacitor should be stored for 1 to 2h at room condition* ² .								
	Capacitance Change	Within ±10%									
	I.R.	1000MΩ min.									
	Dielectric Strength	Per Item 6									
11	Appearance	No marked defect	The capacitor should be firmly soldered to the supporting lead wire and vibrated at a frequency range of 10 to 55Hz, 1.5mm in total amplitude, with about a 1-minute rate of vibration change from 10 to 55Hz and back to 10Hz. Apply for a total of 6h, 2h each in 3 mutually perpendicular directions.								
	Capacitance	Within the specified tolerance									
	D.F. Q	<table border="1"> <thead> <tr> <th>Char.</th> <th>Specifications</th> </tr> </thead> <tbody> <tr> <td>B, E</td> <td>D.F. ≤ 2.5%</td> </tr> <tr> <td>F</td> <td>D.F. ≤ 5.0%</td> </tr> <tr> <td>SL</td> <td> $Q \geq 400 + 20C^{*1}$ (C < 30pF) $Q \geq 1000$ (C ≥ 30pF) </td> </tr> </tbody> </table>		Char.	Specifications	B, E	D.F. ≤ 2.5%	F	D.F. ≤ 5.0%	SL	$Q \geq 400 + 20C^{*1}$ (C < 30pF) $Q \geq 1000$ (C ≥ 30pF)
	Char.	Specifications									
B, E	D.F. ≤ 2.5%										
F	D.F. ≤ 5.0%										
SL	$Q \geq 400 + 20C^{*1}$ (C < 30pF) $Q \geq 1000$ (C ≥ 30pF)										
Dielectric Strength	Per Item 6										
12	Appearance	No marked defect	Set the capacitor for 500±12h at $40\pm 2^{\circ}\text{C}$ in 90 to 95% relative humidity. Post-treatment: Capacitor should be stored for 1 to 2h at room condition* ² .								
	Capacitance Change	<table border="1"> <thead> <tr> <th>Char.</th> <th>Capacitance Change</th> </tr> </thead> <tbody> <tr> <td>B</td> <td>Within ±10%</td> </tr> <tr> <td>E, F</td> <td>Within ±15%</td> </tr> <tr> <td>SL</td> <td>Within ± 5%</td> </tr> </tbody> </table>		Char.	Capacitance Change	B	Within ±10%	E, F	Within ±15%	SL	Within ± 5%
	Char.	Capacitance Change									
	B	Within ±10%									
	E, F	Within ±15%									
	SL	Within ± 5%									
D.F. Q	<table border="1"> <thead> <tr> <th>Char.</th> <th>Specifications</th> </tr> </thead> <tbody> <tr> <td>B, E</td> <td>D.F. ≤ 5.0%</td> </tr> <tr> <td>F</td> <td>D.F. ≤ 7.5%</td> </tr> <tr> <td>SL</td> <td> $Q \geq 275 + 5/2C^{*1}$ (C < 30pF) $Q \geq 350$ (C ≥ 30pF) </td> </tr> </tbody> </table>	Char.	Specifications	B, E	D.F. ≤ 5.0%	F	D.F. ≤ 7.5%	SL	$Q \geq 275 + 5/2C^{*1}$ (C < 30pF) $Q \geq 350$ (C ≥ 30pF)		
Char.	Specifications										
B, E	D.F. ≤ 5.0%										
F	D.F. ≤ 7.5%										
SL	$Q \geq 275 + 5/2C^{*1}$ (C < 30pF) $Q \geq 350$ (C ≥ 30pF)										
I.R.	3000MΩ min.										
Dielectric Strength	Per Item 6										
13	Appearance	No marked defect	Apply the rated voltage for 500±12h at $40\pm 2^{\circ}\text{C}$ in 90 to 95% relative humidity. Post-treatment: Capacitor should be stored for 1 to 2h at room condition* ² .								
	Capacitance Change	<table border="1"> <thead> <tr> <th>Char.</th> <th>Capacitance Change</th> </tr> </thead> <tbody> <tr> <td>B</td> <td>Within ±10%</td> </tr> <tr> <td>E, F</td> <td>Within ±15%</td> </tr> <tr> <td>SL</td> <td>Within ± 5%</td> </tr> </tbody> </table>		Char.	Capacitance Change	B	Within ±10%	E, F	Within ±15%	SL	Within ± 5%
	Char.	Capacitance Change									
	B	Within ±10%									
	E, F	Within ±15%									
SL	Within ± 5%										
D.F. Q	<table border="1"> <thead> <tr> <th>Char.</th> <th>Specifications</th> </tr> </thead> <tbody> <tr> <td>B, E</td> <td>D.F. ≤ 5.0%</td> </tr> <tr> <td>F</td> <td>D.F. ≤ 7.5%</td> </tr> <tr> <td>SL</td> <td> $Q \geq 275 + 5/2C^{*1}$ (C < 30pF) $Q \geq 350$ (C ≥ 30pF) </td> </tr> </tbody> </table>	Char.	Specifications	B, E	D.F. ≤ 5.0%	F	D.F. ≤ 7.5%	SL	$Q \geq 275 + 5/2C^{*1}$ (C < 30pF) $Q \geq 350$ (C ≥ 30pF)		
Char.	Specifications										
B, E	D.F. ≤ 5.0%										
F	D.F. ≤ 7.5%										
SL	$Q \geq 275 + 5/2C^{*1}$ (C < 30pF) $Q \geq 350$ (C ≥ 30pF)										
I.R.	3000MΩ min.										
Dielectric Strength	Per Item 6										

*¹ "C" expresses nominal capacitance value (pF).

*² "Room condition" Temperature: 15 to 35°C, Relative humidity: 45 to 75%, Atmosphere pressure: 86 to 106kPa

Continued on the following page. ↗

Type KY/KX Specifications and Test Methods

Continued from the preceding page. ↘

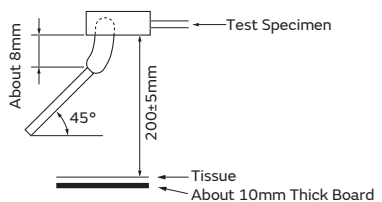
No.	Item	Specifications	Test Method																																																							
17	Passive Flammability	The burning time should not exceed 30s. The tissue paper should not ignite.	<p>The capacitor under test should be held in the flame in the position that best promotes burning. Each specimen should only be exposed once to the flame. Time of exposure to flame: 30s.</p> <p>Length of flame: 12±1mm Gas burner : Length 35mm min. Inside Dia. 0.5±0.1mm Outside Dia. 0.9mm max. Gas : Butane gas Purity 95% min.</p> 																																																							
18	Temperature and Immersion Cycle	<table border="1"> <tr> <td>Appearance</td> <td>No marked defect</td> </tr> <tr> <td rowspan="3">Capacitance Change</td> <td> <table border="1"> <tr> <th>Char.</th> <th>Capacitance Change</th> </tr> <tr> <td>B</td> <td>Within ±10%</td> </tr> <tr> <td>E, F</td> <td>Within ±20%</td> </tr> <tr> <td>SL</td> <td>Within ± 5%</td> </tr> </table> </td> </tr> <tr> <td rowspan="3">D.F. Q</td> <td> <table border="1"> <tr> <th>Char.</th> <th>Specifications</th> </tr> <tr> <td>B, E</td> <td>D.F. ≤5.0%</td> </tr> <tr> <td>F</td> <td>D.F. ≤7.5%</td> </tr> <tr> <td>SL</td> <td>Q ≥ 275 + 5/2C*¹ (C < 30pF) Q ≥ 350 (C ≥ 30pF)</td> </tr> </table> </td> </tr> <tr> <td>I.R.</td> <td>3000MΩ min.</td> </tr> </table> <table border="1"> <tr> <td rowspan="4">Dielectric Strength</td> <td colspan="3">Per Item 6</td> </tr> </table>	Appearance	No marked defect	Capacitance Change	<table border="1"> <tr> <th>Char.</th> <th>Capacitance Change</th> </tr> <tr> <td>B</td> <td>Within ±10%</td> </tr> <tr> <td>E, F</td> <td>Within ±20%</td> </tr> <tr> <td>SL</td> <td>Within ± 5%</td> </tr> </table>	Char.	Capacitance Change	B	Within ±10%	E, F	Within ±20%	SL	Within ± 5%	D.F. Q	<table border="1"> <tr> <th>Char.</th> <th>Specifications</th> </tr> <tr> <td>B, E</td> <td>D.F. ≤5.0%</td> </tr> <tr> <td>F</td> <td>D.F. ≤7.5%</td> </tr> <tr> <td>SL</td> <td>Q ≥ 275 + 5/2C*¹ (C < 30pF) Q ≥ 350 (C ≥ 30pF)</td> </tr> </table>	Char.	Specifications	B, E	D.F. ≤5.0%	F	D.F. ≤7.5%	SL	Q ≥ 275 + 5/2C* ¹ (C < 30pF) Q ≥ 350 (C ≥ 30pF)	I.R.	3000MΩ min.	Dielectric Strength	Per Item 6			<p>The capacitor should be subjected to 5 temperature cycles, then consecutively to 2 immersion cycles.</p> <p><Temperature Cycle></p> <table border="1"> <thead> <tr> <th>Step</th> <th>Temperature (°C)</th> <th>Time (min.)</th> </tr> </thead> <tbody> <tr> <td>1</td> <td>-40+0/-3</td> <td>30</td> </tr> <tr> <td>2</td> <td>Room temp.</td> <td>3</td> </tr> <tr> <td>3</td> <td>125+3/-0</td> <td>30</td> </tr> <tr> <td>4</td> <td>Room temp.</td> <td>3</td> </tr> </tbody> </table> <p style="text-align: right;">Cycle time: 5 cycles</p> <p><Immersion Cycle></p> <table border="1"> <thead> <tr> <th>Step</th> <th>Temperature (°C)</th> <th>Time (min.)</th> <th>Immersion Water</th> </tr> </thead> <tbody> <tr> <td>1</td> <td>65+5/-0</td> <td>15</td> <td>Clean water</td> </tr> <tr> <td>2</td> <td>0±3</td> <td>15</td> <td>Salt water</td> </tr> </tbody> </table> <p style="text-align: right;">Cycle time: 2 cycles</p> <p>Pre-treatment: Capacitor should be stored at 85±2°C for 1h, then placed at room condition*² for 24±2h.</p> <p>Post-treatment: Capacitor should be stored for 24±2h at room condition*².</p>	Step	Temperature (°C)	Time (min.)	1	-40+0/-3	30	2	Room temp.	3	3	125+3/-0	30	4	Room temp.	3	Step	Temperature (°C)	Time (min.)	Immersion Water	1	65+5/-0	15	Clean water	2	0±3	15	Salt water
Appearance	No marked defect																																																									
Capacitance Change	<table border="1"> <tr> <th>Char.</th> <th>Capacitance Change</th> </tr> <tr> <td>B</td> <td>Within ±10%</td> </tr> <tr> <td>E, F</td> <td>Within ±20%</td> </tr> <tr> <td>SL</td> <td>Within ± 5%</td> </tr> </table>	Char.	Capacitance Change	B		Within ±10%	E, F	Within ±20%	SL	Within ± 5%																																																
	Char.	Capacitance Change																																																								
	B	Within ±10%																																																								
E, F	Within ±20%																																																									
SL	Within ± 5%																																																									
D.F. Q	<table border="1"> <tr> <th>Char.</th> <th>Specifications</th> </tr> <tr> <td>B, E</td> <td>D.F. ≤5.0%</td> </tr> <tr> <td>F</td> <td>D.F. ≤7.5%</td> </tr> <tr> <td>SL</td> <td>Q ≥ 275 + 5/2C*¹ (C < 30pF) Q ≥ 350 (C ≥ 30pF)</td> </tr> </table>	Char.	Specifications	B, E	D.F. ≤5.0%	F	D.F. ≤7.5%	SL	Q ≥ 275 + 5/2C* ¹ (C < 30pF) Q ≥ 350 (C ≥ 30pF)																																																	
	Char.	Specifications																																																								
	B, E	D.F. ≤5.0%																																																								
F	D.F. ≤7.5%																																																									
SL	Q ≥ 275 + 5/2C* ¹ (C < 30pF) Q ≥ 350 (C ≥ 30pF)																																																									
I.R.	3000MΩ min.																																																									
Dielectric Strength	Per Item 6																																																									
	Step	Temperature (°C)	Time (min.)																																																							
	1	-40+0/-3	30																																																							
	2	Room temp.	3																																																							
3	125+3/-0	30																																																								
4	Room temp.	3																																																								
Step	Temperature (°C)	Time (min.)	Immersion Water																																																							
1	65+5/-0	15	Clean water																																																							
2	0±3	15	Salt water																																																							

*¹ "C" expresses nominal capacitance value (pF).

*² "Room condition" Temperature: 15 to 35°C, Relative humidity: 45 to 75%, Atmosphere pressure: 86 to 106kPa

Characteristics Data (Typical Example)

Capacitance - Temperature Characteristics

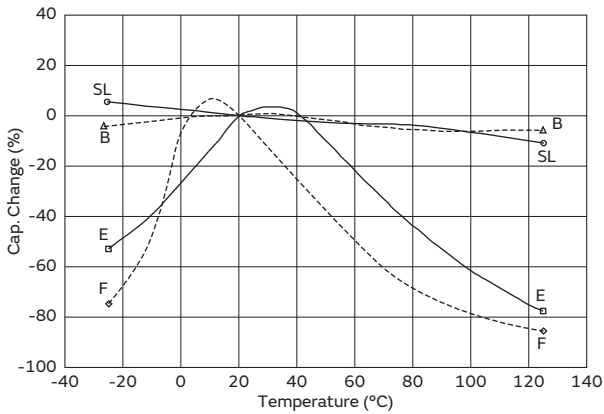

Insertion Loss - Frequency Characteristics

Type SA (AC400V(r.m.s.))

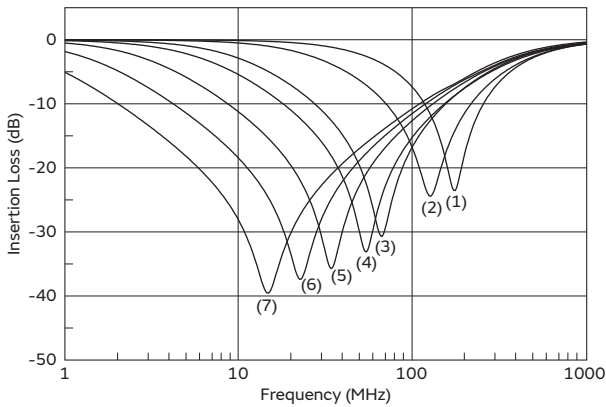

- Type SA (AC400V(r.m.s.)) (Out Put Power) 100mW (20dBm)
- (1) DE2B3SA101KA3BY02F
 - (2) DE2B3SA221KA3BY02F
 - (3) DE2B3SA681KA3BY02F
 - (4) DE2E3SA102MA3BY02F
 - (5) DE2E3SA222MA3BY02F
 - (6) DE2E3SA472MA3BY02F
 - (7) DE2E3SA103MA3BY02F

Type RA (AC500V(r.m.s.))

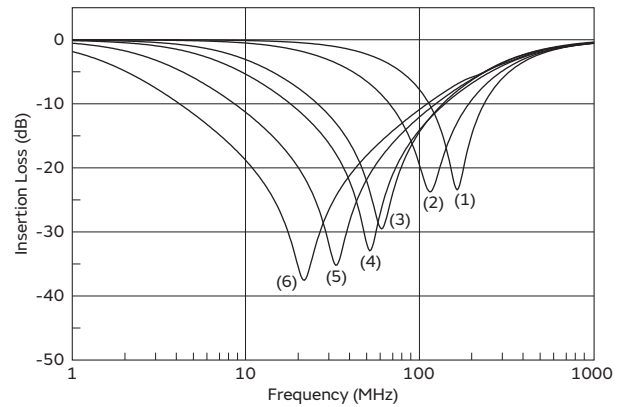

- Type RA (AC500V(r.m.s.)) (Out Put Power) 100mW (20dBm)
- (1) DE1B3RA101KA4BQ01F
 - (2) DE1B3RA221KA4BQ01F
 - (3) DE1B3RA681KA4BQ01F
 - (4) DE1E3RA102MA4BQ01F
 - (5) DE1E3RA222MA4BQ01F
 - (6) DE1E3RA472MA4BQ01F
 - (7) DE1E3RA103MA4BQ01F

Type SA (AC250V(r.m.s.))

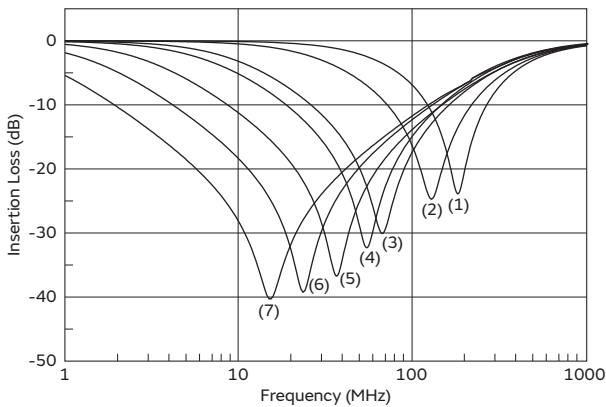

- Type SA (AC250V(r.m.s.)) (Out Put Power) 100mW (20dBm)
- (1) DE2B3SA101KA3BT02F
 - (2) DE2B3SA221KA3BT02F
 - (3) DE2B3SA681KA3BT02F
 - (4) DE2E3SA102MA3BT02F
 - (5) DE2E3SA222MA3BT02F
 - (6) DE2E3SA472MA3BT02F
 - (7) DE2E3SA103MA3BT02F

Type RA (AC250V(r.m.s.))

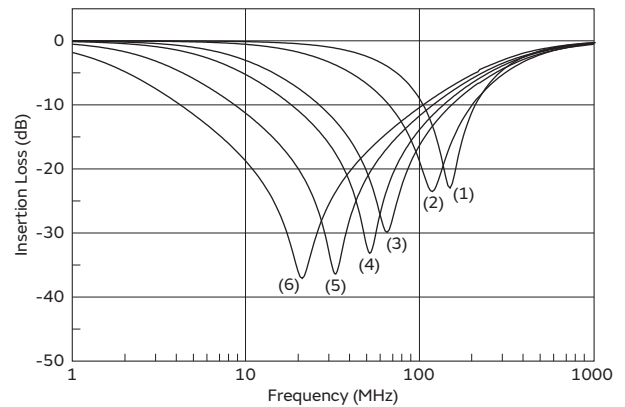

- Type RA (AC250V(r.m.s.)) (Out Put Power) 100mW (20dBm)
- (1) DE1B3RA101KA4BN01F
 - (2) DE1B3RA221KA4BN01F
 - (3) DE1B3RA681KA4BN01F
 - (4) DE1E3RA102MA4BN01F
 - (5) DE1E3RA222MA4BN01F
 - (6) DE1E3RA472MA4BN01F
 - (7) DE1E3RA103MA4BN01F

Continued on the following page. ↗

Characteristics Data (Typical Example)

Continued from the preceding page. ↘

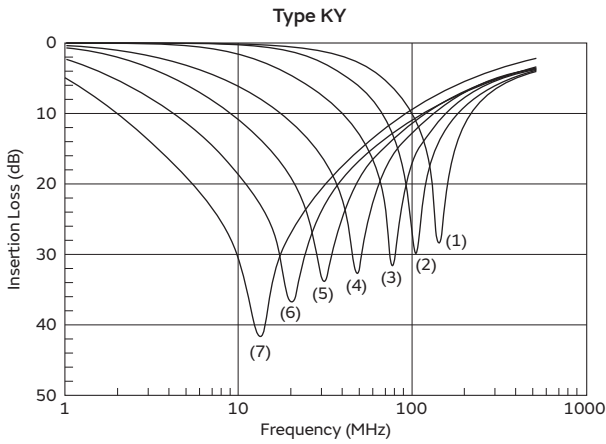

Type KY
 Signal power: 1mW
 (1) DE2B3KY101KA2B****
 (2) DE2B3KY221KA2B****
 (3) DE2B3KY471KA2B****
 (4) DE2E3KY102MA2B****
 (5) DE2E3KY222MA2B****
 (6) DE2E3KY472MA2B****
 (7) DE2F3KY103MA3B****

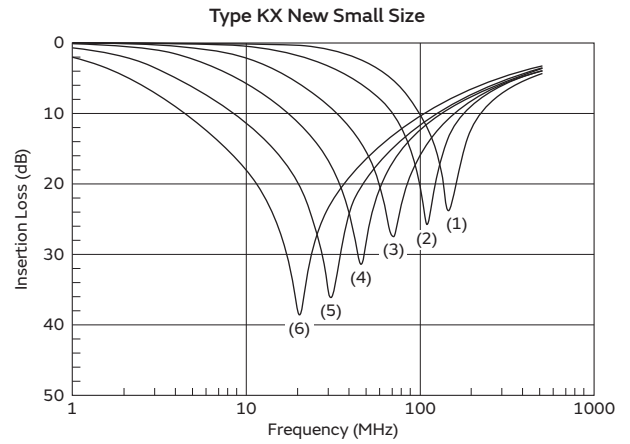

Type KX New Small Size
 Signal power: 1mW
 (1) DE1B3KX101KA4BN01F
 (2) DE1B3KX221KA4BN01F
 (3) DE1B3KX471KA4BN01F
 (4) DE1E3KX102MA4BN01F
 (5) DE1E3KX222MA4BN01F
 (6) DE1E3KX472MA4BN01F

Leakage Current Characteristics

Type SA (AC400V(r.m.s.)) (B char.)

AC voltage : 60Hz
 Temperature: 25°C

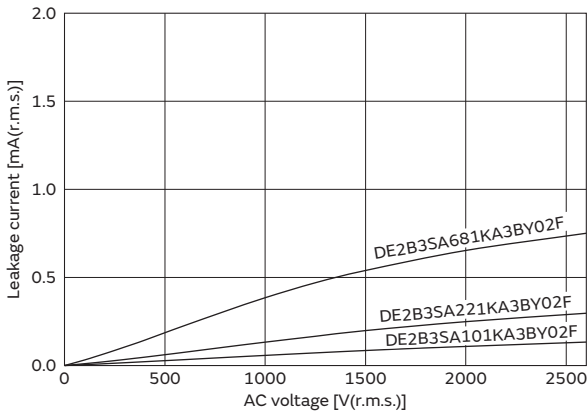

Type SA (AC400V(r.m.s.)) (E char.)

AC voltage : 60Hz
 Temperature: 25°C

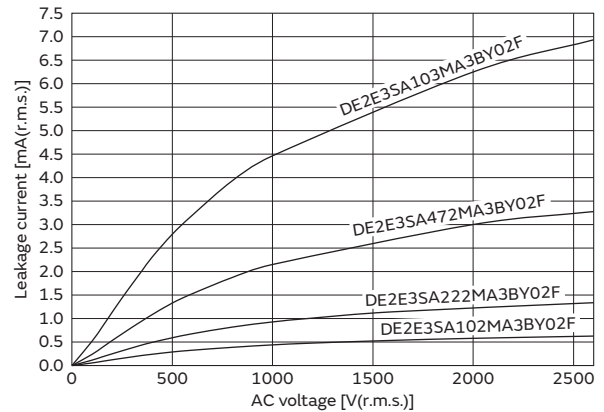

Type RA (AC500V(r.m.s.)) (B char.)

AC voltage : 60Hz
 Temperature: 25°C

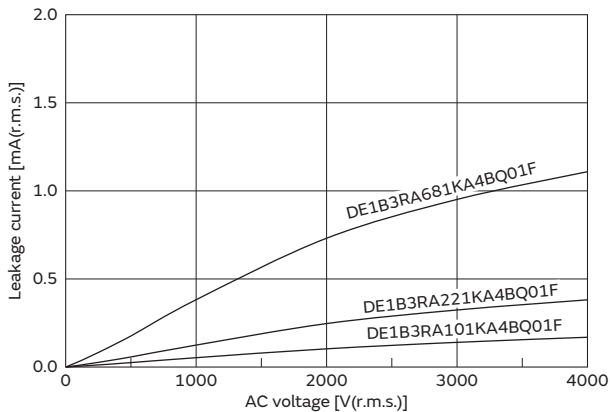

Type RA (AC500V(r.m.s.)) (E char.)

AC voltage : 60Hz
 Temperature: 25°C

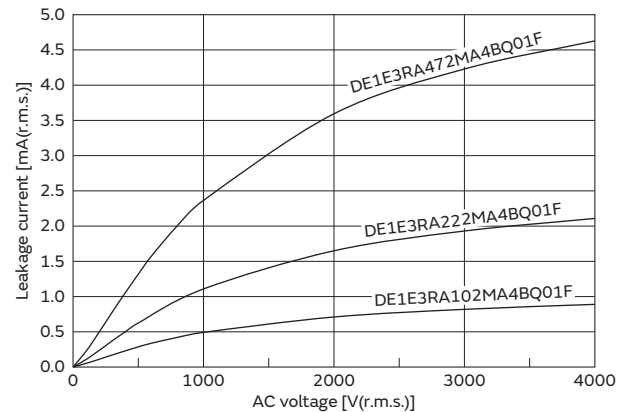

Continued on the following page. ↗

Characteristics Data (Typical Example)

Continued from the preceding page. ↘

Type SA (AC250V(r.m.s.)) (B char.)

AC voltage : 60Hz
 Temperature: 25°C

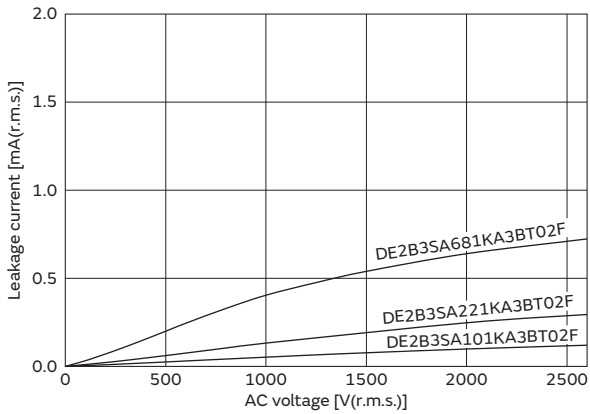

Type SA (AC250V(r.m.s.)) (E char.)

AC voltage : 60Hz
 Temperature: 25°C

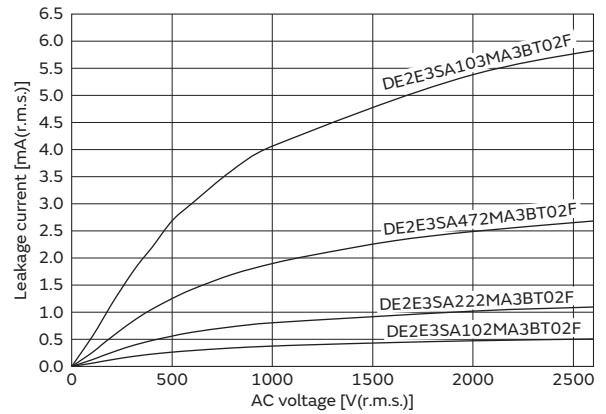

Type RA (AC250V(r.m.s.)) (B char.)

AC voltage : 60Hz
 Temperature: 25°C

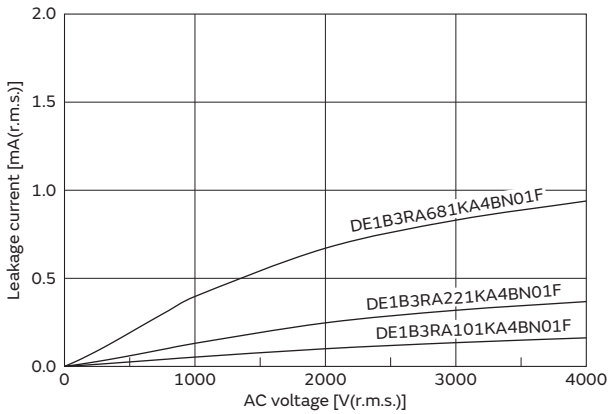

Type RA (AC250V(r.m.s.)) (E char.)

AC voltage : 60Hz
 Temperature: 25°C

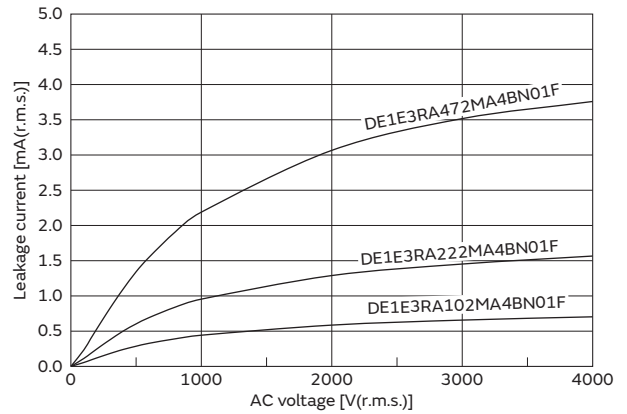

Type KY (B char.)

AC voltage : 60Hz
 Temperature: 25°C

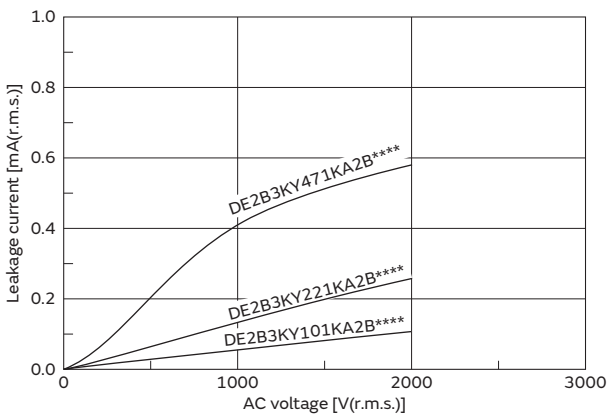

Type KY (E,F char.)

AC voltage : 60Hz
 Temperature: 25°C

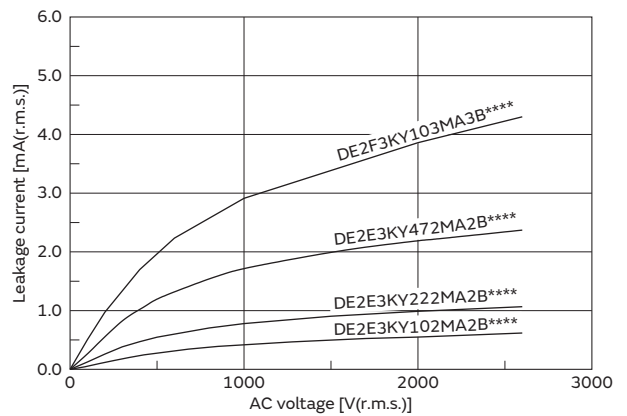

Continued on the following page. ↗

Characteristics Data (Typical Example)

Continued from the preceding page. ↘

Type KX New Small Size (B char.)

AC voltage : 60Hz
 Temperature: 25°C

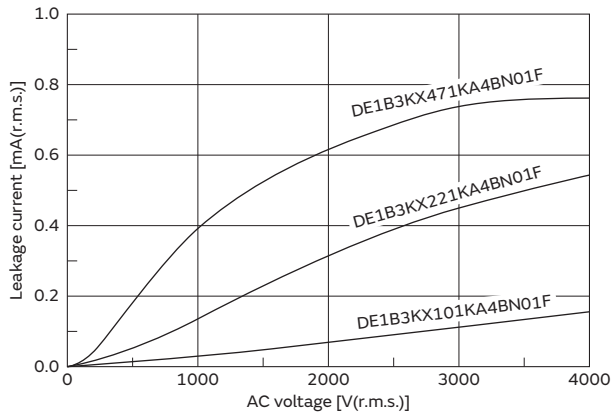

Type KX New Small Size (E char.)

AC voltage : 60Hz
 Temperature: 25°C

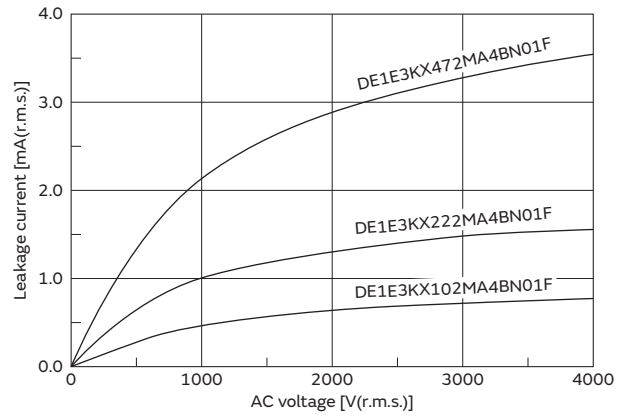

Packaging

Taping Specifications

- 12.7mm pitch / lead spacing 5mm taping
 Vertical crimp type
 (Lead Code: N2)

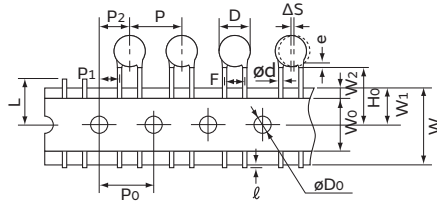

- 15mm pitch / lead spacing 7.5mm taping
 Vertical crimp type
 (Lead Code: N3)

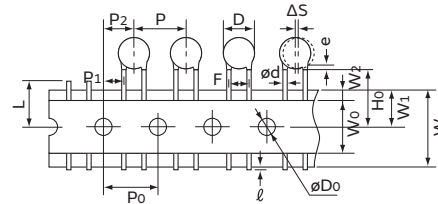

- 30mm pitch / lead spacing 7.5mm taping
 Vertical crimp type
 (Lead Code: N7)

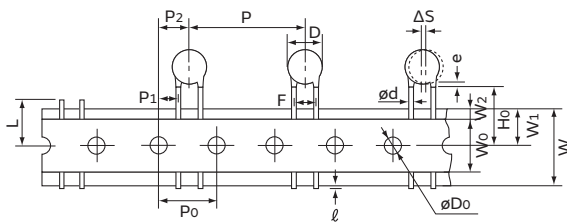

- 25.4mm pitch / lead spacing 10.0mm taping
 Vertical crimp type
 (Lead Code: N4)

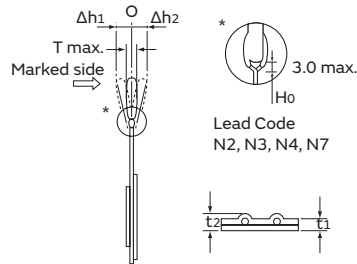
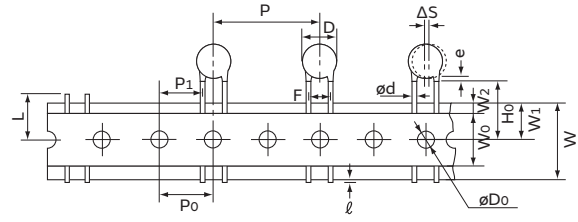

Lead Code
 N2, N3, N4, N7

Item	Code	N2	N3	N7	N4
Pitch of component	P	12.7±1.0	15.0±2.0	30.0±2.0	25.4±2.0
Pitch of sprocket hole	P0	12.7±0.3	15.0±0.3		12.7±0.3
Lead spacing	F	5.0 ^{+0.8} _{-0.2}	7.5±1.0		10.0±1.0
Length from hole center to component center	P2	6.35±1.3	7.5±1.5		—
Length from hole center to lead	P1	3.85±0.7	3.75±1.0		7.7±1.5
Body diameter	D	See the individual product specifications.			
Deviation along tape, left or right	ΔS	0±1.0	0±2.0		
Carrier tape width	W	18.0±0.5			
Position of sprocket hole	W1	9.0±0.5			
Lead distance between reference and bottom planes	H0	18.0 ^{+2.0} ₋₀			18.0 ^{+2.0} ₋₀
	H	—			—
Protrusion length	ℓ	+0.5 to -1.0			
Diameter of sprocket hole	∅Do	4.0±0.1			
Lead diameter	∅d	0.6±0.05			
Total tape thickness	t1	0.6±0.3			
Total thickness, tape and lead wire	t2	1.5 max.			
Body thickness	T	See the individual product specifications.			
Portion to cut in case of defect	L	11.0 ⁺⁰ _{-1.0}			
Hold down tape width	W0	11.5 min.			
Hold down tape position	W2	1.5±1.5			
Coating extension on lead	e	Up to the end of crimp		Up to the end of crimp	
Deviation across tape, front	Δh1	1.0 max.		2.0 max.	
Deviation across tape, rear	Δh2				



(in mm)

Continued on the following page. ↗

Packaging

Continued from the preceding page. ↘

Packaging Styles

Bulk	Taping
Polyethylene Bag 	Ammo Pack 

Minimum Quantity (Order in Sets Only)

[Bulk]	(pcs./Bag)		
	Body Dia. D (mm)	Lead Code A□	Lead Code B□, J□
		Long	Short
Type SA	6	500	500
Type RA	7	250 *1	500
Type RB	8 to 11	250	500
Type KY	12 to 14	200	250
Type KX (New Small Size)	15 to 17	100	200

*1 Lead Spacing F=5.0mm (Code: A2): 500pcs.

[Taping]	(pcs./Ammo Pack)			
Lead Code	N2	N3	N4	N7
Type SA (AC400V)	–	900	–	400
Type SA (AC250V or AC300V)	1,500 *2	1,000	–	400
Type RA (AC500V), Type RB	–	–	500	–
Type RA (AC250V or AC300V)	–	–	600	–
Type KY	1,000	900	–	–
Type KX (New Small Size)	–	–	500	–

*2 Body Dia. D (mm) 9, 10: 1,000pcs.

⚠Caution

⚠Caution (Rating)

1. Operating Voltage

When DC-rated capacitors are to be used in AC or ripple current circuits, be sure to maintain the V_{p-p} value of the applied voltage or the V_{o-p} that contains DC bias within the rated voltage range.

When the voltage is applied to the circuit, starting or stopping may generate irregular voltage for a transit period because of resonance or switching. Be sure to use a capacitor with a rated voltage range that includes these irregular voltages.

Voltage	DC Voltage	DC+AC Voltage	AC Voltage	Pulse Voltage (1)	Pulse Voltage (2)
Positional Measurement					

2. Operating Temperature and Self-generated Heat (Apply to B/E/F Char.)

Keep the surface temperature of a capacitor below the upper limit of its rated operating temperature range. Be sure to take into account the heat generated by the capacitor itself. When the capacitor is used in a high-frequency current, pulse current or similar current, it may have self-generated heat due to dielectric loss. Applied voltage load should be such that self-generated heat is within 20°C under the condition where the capacitor is subjected to an atmospheric temperature of 25°C. When measuring, use a thermocouple of small thermal capacity-K of $\phi 0.1\text{mm}$ under conditions where the capacitor is not affected by radiant heat from other components or wind from surroundings. Excessive heat may lead to deterioration of the capacitor's characteristics and reliability. (Never attempt to perform measurement with the cooling fan running. Otherwise, accurate measurement cannot be ensured.)

3. Test Condition for Withstanding Voltage

(1) Test Equipment

Test equipment for AC withstanding voltage should be used with the performance of the wave similar to 50/60Hz sine wave.

If the distorted sine wave or overload exceeding the specified voltage value is applied, a defect may be caused.

Continued on the following page. ↗

⚠️Caution

Continued from the preceding page. ↘

(2) Voltage Applied Method

When the withstanding voltage is applied, the capacitor's lead or terminal should be firmly connected to the output of the withstanding voltage test equipment, and then the voltage should be raised from near zero to the test voltage.

If the test voltage without the raise from near zero voltage would be applied directly to capacitor, test voltage should be applied with the zero cross.* At the end of the test time, the test voltage should be reduced to near zero, and then capacitor's lead or terminal should be taken off the output of the withstanding voltage test equipment.

If the test voltage without the raise from near zero voltage would be applied directly to capacitor, the surge voltage may rise, and therefore, a defect may be caused.

*ZERO CROSS is the point where voltage sine wave passes 0V. See the figure at right.

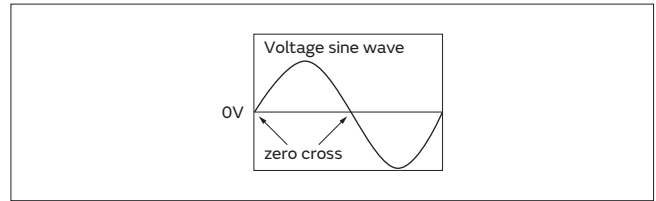

4. Fail-Safe

When the capacitor is broken, failure may result in a short circuit. Be sure to provide an appropriate fail-safe function like a fuse on your product if failure could result in an electric shock, fire or fuming.

FAILURE TO FOLLOW THE ABOVE CAUTIONS MAY RESULT, WORST CASE, IN A SHORT CIRCUIT AND CAUSE FUMING OR PARTIAL DISPERSION WHEN THE PRODUCT IS USED.

⚠️Caution

⚠️Caution (Storage and Operating Condition)

Operating and Storage Environment

The insulating coating of capacitors does not form a perfect seal; therefore, do not use or store capacitors in a corrosive atmosphere, especially where chloride gas, sulfide gas, acid, alkali, salt or the like are present. Also, avoid exposure to moisture. Before cleaning, bonding, or molding this product, verify that these processes do not affect product quality by testing the performance of a cleaned, bonded or molded product in the intended equipment. Store the capacitors where the temperature and relative humidity do not exceed -10 to 40 degrees centigrade and 15 to 85%.

Use capacitors within 6 months after delivery.
Check the solderability after 6 months or more.

FAILURE TO FOLLOW THE ABOVE CAUTIONS MAY RESULT, WORST CASE, IN A SHORT CIRCUIT AND CAUSE FUMING OR PARTIAL DISPERSION WHEN THE PRODUCT IS USED.

⚠️Caution (Soldering and Mounting)

1. Vibration and Impact

Do not expose a capacitor or its lead wires to excessive shock or vibration during use. Excessive shock or vibration may cause fatigue destruction of lead wires mounted on the circuit board.
Please take measures to hold a capacitor on the circuit boards by adhesive, molding resin or another coating.
Please confirm there is no influence of holding measures on the product with the intended equipment.

2. Soldering

When soldering this product to a PCB/PWB, do not exceed the solder heat resistance specifications of the capacitor. Subjecting this product to excessive heating could melt the internal junction solder and may result in thermal shocks that can crack the ceramic element.
Soldering the capacitor with a soldering iron should be performed in the following conditions.
Temperature of iron-tip: 400 degrees C. max.
Soldering iron wattage: 50W max.
Soldering time: 3.5 sec. max.

3. Bonding, Resin Molding and Coating

For bonding, molding or coating this product, verify that these processes do not affect the quality of the capacitor by testing the performance of the bonded, molded or coated product in the intended equipment. When the amount of applications, dryness/hardening conditions of adhesives and molding resins containing organic solvents (ethyl acetate, methyl ethyl ketone, toluene, etc). are unsuitable, the outer coating resin of a capacitor is damaged by the organic solvents and it may result, worst case, in a short circuit.
The variation in thickness of adhesive, molding resin or coating may cause outer coating resin cracking and/or ceramic element cracking of a capacitor in a temperature cycling.

4. Treatment after Bonding, Resin Molding and Coating

When the outer coating is hot (over 100 degrees C.) after soldering, it becomes soft and fragile. Therefore, please be careful not to give it mechanical stress.

FAILURE TO FOLLOW THE ABOVE CAUTIONS MAY RESULT, WORST CASE, IN A SHORT CIRCUIT AND CAUSE FUMING OR PARTIAL DISPERSION WHEN THE PRODUCT IS USED.

⚠️Caution (Handling)

Vibration and Impact

Do not expose a capacitor or its lead wires to excessive shock or vibration during use. Excessive shock or vibration may cause fatigue destruction of lead wires mounted on the circuit board.
Please take measures to hold a capacitor on the circuit boards by adhesive, molding resin or another coating.

Please confirm there is no influence of holding measures on the product with the intended equipment.

FAILURE TO FOLLOW THE ABOVE CAUTIONS MAY RESULT, WORST CASE, IN A SHORT CIRCUIT AND CAUSE FUMING OR PARTIAL DISPERSION WHEN THE PRODUCT IS USED.

Notice

Notice (Soldering and Mounting)

Cleaning (ultrasonic cleaning)

To perform ultrasonic cleaning, observe the following conditions.

Rinse bath capacity: Output of 20 watts per liter or less.

Rinsing time: 5min maximum.

Do not vibrate the PCB/PWB directly.

Excessive ultrasonic cleaning may lead to fatigue destruction of the lead wires.

Notice (Rating)

1. Capacitance Change of Capacitors

(1) For SL char.

Capacitance might change a little depending on a surrounding temperature or an applied voltage.

Please contact us if you use a strict constant time circuit.

(2) For B/E/F char.

Capacitors have an aging characteristic, whereby the capacitor continually decreases its capacitance slightly if the capacitor is left on for a long time. Moreover, capacitance might change greatly depending on the surrounding temperature or an applied voltage. Therefore, it is not likely to be suitable for use in a constant time circuit.

Please contact us if you need detailed information.

2. Performance Check by Equipment

Before using a capacitor, check that there is no problem in the equipment's performance and the specifications.

Generally speaking, CLASS 2 (B/E/F char.) ceramic capacitors have voltage dependence characteristics and temperature dependence characteristics in capacitance, so the capacitance value may change depending on the operating condition in the equipment. Therefore, be sure to confirm the apparatus performance of receiving influence in the capacitance value change of a capacitor, such as leakage current and noise suppression characteristic.

Moreover, check the surge-proof ability of a capacitor in the equipment, if needed, because the surge voltage may exceed specific value by the inductance of the circuit.

Safety Standard Certified Lead Type Disc Ceramic Capacitors for Automotive

Type KJ -Class X1, Y2- (For Automotive Use/AC Line Filter of PHEV/EV Charger)

Features

1. Capacitors designed for AC line filters for PHEV/EV.
2. Meet AEC-Q200
3. Heat cycle: 1000cycle (-55/+125 deg.)
4. Class X1/Y2 capacitors certified by UL/ENEC(VDE).
5. Rated Voltage: AC300V
6. Coated with flame-retardant epoxy resin (conforming to UL94V-0 standard).
7. Available product for RoHS Restriction (EU Directive 2002/95/EC).
8. Taping available for automatic insertion.

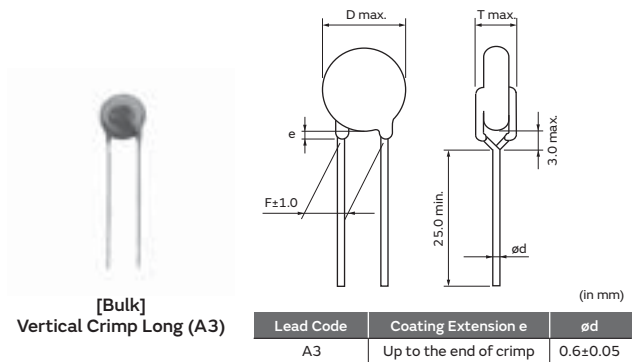

Applications

1. Ideal for use as Y capacitors for AC line filters and primary-secondary coupling on battery chargers for PHEV/EV.
2. Ideal for use as a filter capacitor for DC-DC converters for PHEV/EV and HEV.

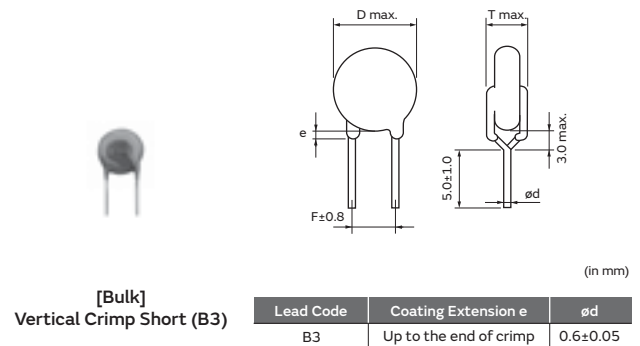

Standard Certification

	Standard No.	Certified No.	Rated Voltage
UL	UL 60384-14	E37921	AC300V(r.m.s.)
ENEC (VDE)	EN 60384-14 IEC 60384-14	40031217	

Marking

Example	Item
	① Type Designation KJ
	② Nominal Capacitance (Marked with 3 figures)
	③ Capacitance Tolerance
	④ Company Name Code Ⓞ15: Made in Thailand
	⑤ Manufactured Date Code
	Class Code X1Y2
	Rated Voltage Mark 300~

Part Number	AC Rated Voltage	Temp. Char.	Capacitance	Body Dia. D	Lead Spacing F (mm)	Body Thickness T	Lead Package Long Bulk	Lead Package Short Bulk	Lead Package Taping
DE6B3KJ101K□□□	300Vac(r.m.s.)	B	100pF±10%	8.0mm max.	7.5	7.0mm max.	A3B	B3B	N3A
DE6B3KJ151K□□□	300Vac(r.m.s.)	B	150pF±10%	8.0mm max.	7.5	7.0mm max.	A3B	B3B	N3A
DE6B3KJ221K□□□	300Vac(r.m.s.)	B	220pF±10%	8.0mm max.	7.5	7.0mm max.	A3B	B3B	N3A
DE6B3KJ331K□□□	300Vac(r.m.s.)	B	330pF±10%	8.0mm max.	7.5	7.0mm max.	A3B	B3B	N3A
DE6B3KJ471K□□□	300Vac(r.m.s.)	B	470pF±10%	8.0mm max.	7.5	7.0mm max.	A3B	B3B	N3A
DE6B3KJ681K□□□	300Vac(r.m.s.)	B	680pF±10%	9.0mm max.	7.5	7.0mm max.	A3B	B3B	N3A
DE6E3KJ102M□□□	300Vac(r.m.s.)	E	1000pF±20%	7.0mm max.	7.5	7.0mm max.	A3B	B3B	N3A
DE6E3KJ152M□□□	300Vac(r.m.s.)	E	1500pF±20%	8.0mm max.	7.5	7.0mm max.	A3B	B3B	N3A
DE6E3KJ222M□□□	300Vac(r.m.s.)	E	2200pF±20%	9.0mm max.	7.5	7.0mm max.	A3B	B3B	N3A
DE6E3KJ332M□□□	300Vac(r.m.s.)	E	3300pF±20%	10.0mm max.	7.5	7.0mm max.	A3B	B3B	N3A
DE6E3KJ472M□□□	300Vac(r.m.s.)	E	4700pF±20%	12.0mm max.	7.5	7.0mm max.	A3B	B3B	N3A

Three blank columns are filled with the lead and packaging codes. Please refer to the 3 columns on the right for the appropriate code. Murata part numbers might be changed depending on lead code or any other changes. Therefore, please specify only the type name (KJ) and capacitance of products in the parts list when it is required for applying safety standard of electric equipment.

Type KJ Specifications and Test Methods

Operating Temperature Range: -40 to +125°C

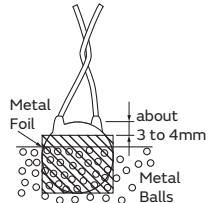
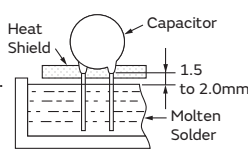
No.	Item	Specifications	Test Method																		
1	Appearance and Dimensions	No visible defect, and dimensions are within specified range.	The capacitor should be visually inspected for evidence of defect. Dimensions should be measured with slide calipers.																		
2	Marking	To be easily legible	The capacitor should be visually inspected.																		
3	Capacitance	Within specified tolerance																			
4	Dissipation Factor (D.F.)	<table border="1"> <thead> <tr> <th>Char.</th> <th>Specifications</th> </tr> </thead> <tbody> <tr> <td>B, E</td> <td>D.F. ≤ 2.5%</td> </tr> </tbody> </table>	Char.	Specifications	B, E	D.F. ≤ 2.5%	The dissipation factor should be measured at 20°C with 1±0.1kHz and AC5V(r.m.s.) max.														
Char.	Specifications																				
B, E	D.F. ≤ 2.5%																				
5	Insulation Resistance (I.R.)	10000MΩ min.	The insulation resistance should be measured with DC500±50V within 60±5s of charging. The voltage should be applied to the capacitor through a resistor of 1MΩ.																		
6	Between Lead Wires	No failure	The capacitor should not be damaged when the test voltages from Table 1 are applied between the lead wires for 60s. <table border="1"> <thead> <tr> <th>Type</th> <th>Test Voltage</th> </tr> </thead> <tbody> <tr> <td>KJ</td> <td>AC2600V(r.m.s.) <50/60Hz></td> </tr> </tbody> </table>	Type	Test Voltage	KJ	AC2600V(r.m.s.) <50/60Hz>														
	Type	Test Voltage																			
KJ	AC2600V(r.m.s.) <50/60Hz>																				
Body Insulation	No failure	First, the terminals of the capacitor should be connected together. Then, as shown in the figure at right, a metal foil should be closely wrapped around the body of the capacitor to the distance of about 3 to 4mm from each terminal.  Then, the capacitor should be inserted into a container filled with metal balls of about 1mm diameter. Finally, AC voltage from Table 2 is applied for 60s between the capacitor lead wires and metal balls. <table border="1"> <thead> <tr> <th>Type</th> <th>Test Voltage</th> </tr> </thead> <tbody> <tr> <td>KJ</td> <td>AC2600V(r.m.s.) <50/60Hz></td> </tr> </tbody> </table>	Type	Test Voltage	KJ	AC2600V(r.m.s.) <50/60Hz>															
Type	Test Voltage																				
KJ	AC2600V(r.m.s.) <50/60Hz>																				
7	Temperature Characteristics	<table border="1"> <thead> <tr> <th>Char.</th> <th>Capacitance Change</th> </tr> </thead> <tbody> <tr> <td>B</td> <td>Within ±10%</td> </tr> <tr> <td>E</td> <td>Within ±20%</td> </tr> </tbody> </table> (Temp. range: -25 to +85°C)	Char.	Capacitance Change	B	Within ±10%	E	Within ±20%	The capacitance measurement should be made at each step specified in Table 3. <table border="1"> <thead> <tr> <th>Step</th> <th>Temperature (°C)</th> </tr> </thead> <tbody> <tr> <td>1</td> <td>20±2</td> </tr> <tr> <td>2</td> <td>-25±2</td> </tr> <tr> <td>3</td> <td>20±2</td> </tr> <tr> <td>4</td> <td>85±2</td> </tr> <tr> <td>5</td> <td>20±2</td> </tr> </tbody> </table> Pre-treatment: Capacitor should be stored at 125±3°C for 1h, then placed at room condition* for 24±2h before initial measurements.	Step	Temperature (°C)	1	20±2	2	-25±2	3	20±2	4	85±2	5	20±2
Char.	Capacitance Change																				
B	Within ±10%																				
E	Within ±20%																				
Step	Temperature (°C)																				
1	20±2																				
2	-25±2																				
3	20±2																				
4	85±2																				
5	20±2																				
8	Solderability	Lead wire should be soldered with uniform coating on the axial direction over 3/4 of the circumferential direction.	Should be placed into steam aging for 8h±15min. After the steam aging, the lead wire of a capacitor should be dipped into an ethanol solution of 25% rosin and then into molten solder for 5+0/-0.5s. The depth of immersion is up to about 1.5 to 2.0mm from the root of lead wires. Temp. of solder: Lead Free Solder (Sn-3Ag-0.5Cu) 245±5°C H63 Eutectic Solder 235±5°C																		
9	Appearance	No marked defect	As shown in the figure, the lead wires should be immersed in solder of 260±5°C up to 1.5 to 2.0mm from the root of terminal for 10±1s.  Pre-treatment: Capacitor should be stored at 125±3°C for 1h, then placed at room condition* for 24±2h before initial measurements. Post-treatment: Capacitor should be stored for 1 to 2h at room condition*.																		
	Capacitance Change	Within ±10%																			
	I.R.	1000MΩ min.																			
	Dielectric Strength	Per Item 6																			

* "Room condition" Temperature: 15 to 35°C, Relative humidity: 45 to 75%, Atmosphere pressure: 86 to 106kPa

Continued on the following page. ↗

Type KJ Specifications and Test Methods

Continued from the preceding page. ↘

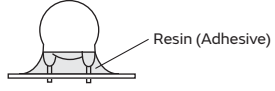
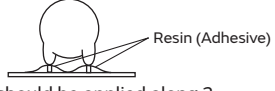
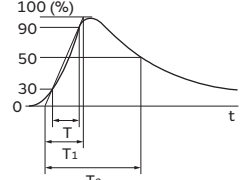
No.	Item	Specifications	Test Method						
10	Appearance	No marked defect	Solder the capacitor and gum up the body to the test jig (glass epoxy board) by resin (adhesive).  The capacitor should be firmly soldered to the supporting lead wire, 1.5mm in total amplitude, with about a 20 minutes rate of vibration change from 10Hz to 2000Hz and back to 10Hz. This motion should be applied 12 times in each of 3 mutually perpendicular directions (total of 36 times). The acceleration is 5g max.						
	Capacitance	Within the specified tolerance							
	D.F.	<table border="1"> <thead> <tr> <th>Char.</th> <th>Specifications</th> </tr> </thead> <tbody> <tr> <td>B, E</td> <td>D.F. ≤2.5%</td> </tr> </tbody> </table>		Char.	Specifications	B, E	D.F. ≤2.5%		
Char.	Specifications								
B, E	D.F. ≤2.5%								
11	Appearance	No marked defect	Solder the capacitor and gum up the body to the test jig (glass epoxy board) by resin (adhesive).  Three shocks in each direction should be applied along 3 mutually perpendicular axes to and from of the test specimen (18 shocks). The specified test pulse should be half-sine and should have a duration: 0.5ms, peak value: 100g and velocity change: 4.7m/s						
	Capacitance	Within the specified tolerance							
	D.F.	<table border="1"> <thead> <tr> <th>Char.</th> <th>Specifications</th> </tr> </thead> <tbody> <tr> <td>B, E</td> <td>D.F. ≤5.0%</td> </tr> </tbody> </table>		Char.	Specifications	B, E	D.F. ≤5.0%		
	Char.	Specifications							
B, E	D.F. ≤5.0%								
I.R.	10000MΩ min.								
12	Appearance	No marked defect	Set the capacitor for 1000±12h at 85±3°C in 80 to 85% relative humidity. Pre-treatment: Capacitor should be stored at 125±3°C for 1h, then placed at room condition* for 24±2h before initial measurements. Post-treatment: Capacitor should be stored for 1 to 2h at room condition*.						
	Capacitance Change	<table border="1"> <thead> <tr> <th>Char.</th> <th>Capacitance Change</th> </tr> </thead> <tbody> <tr> <td>B</td> <td>Within ±10%</td> </tr> <tr> <td>E</td> <td>Within ±15%</td> </tr> </tbody> </table>		Char.	Capacitance Change	B	Within ±10%	E	Within ±15%
	Char.	Capacitance Change							
	B	Within ±10%							
	E	Within ±15%							
D.F.	<table border="1"> <thead> <tr> <th>Char.</th> <th>Specifications</th> </tr> </thead> <tbody> <tr> <td>B, E</td> <td>D.F. ≤5.0%</td> </tr> </tbody> </table>	Char.	Specifications	B, E	D.F. ≤5.0%				
Char.	Specifications								
B, E	D.F. ≤5.0%								
I.R.	3000MΩ min.								
Dielectric Strength	Per Item 6								
13	Appearance	No marked defect	Apply the rated voltage for 1000±12h at 85±3°C in 80 to 85% relative humidity. Pre-treatment: Capacitor should be stored at 125±3°C for 1h, then placed at room condition* for 24±2h before initial measurements. Post-treatment: Capacitor should be stored for 1 to 2h at room condition*.						
	Capacitance Change	<table border="1"> <thead> <tr> <th>Char.</th> <th>Capacitance Change</th> </tr> </thead> <tbody> <tr> <td>B</td> <td>Within ±10%</td> </tr> <tr> <td>E</td> <td>Within ±15%</td> </tr> </tbody> </table>		Char.	Capacitance Change	B	Within ±10%	E	Within ±15%
	Char.	Capacitance Change							
	B	Within ±10%							
E	Within ±15%								
D.F.	<table border="1"> <thead> <tr> <th>Char.</th> <th>Specifications</th> </tr> </thead> <tbody> <tr> <td>B, E</td> <td>D.F. ≤5.0%</td> </tr> </tbody> </table>	Char.	Specifications	B, E	D.F. ≤5.0%				
Char.	Specifications								
B, E	D.F. ≤5.0%								
I.R.	3000MΩ min.								
14	Appearance	No marked defect	Impulse Voltage Each individual capacitor should be subjected to a 5kV impulses for three times. Then the capacitors are applied to life test.  Front time (T ₁) = 1.2μs = 1.67T Time to half-value (T ₂) = 50μs						
	Capacitance Change	Within ±20%							
	I.R.	3000MΩ min.							
	Dielectric Strength	Per Item 6							

* "Room condition" Temperature: 15 to 35°C, Relative humidity: 45 to 75%, Atmosphere pressure: 86 to 106kPa

Continued on the following page. ↗

Type KJ Specifications and Test Methods

Continued from the preceding page. ↘

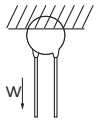
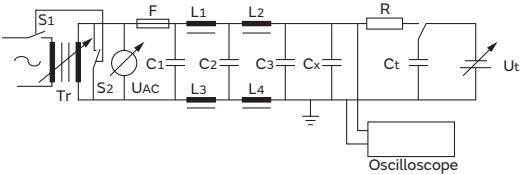
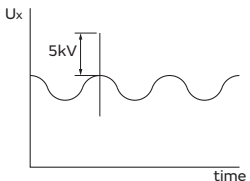
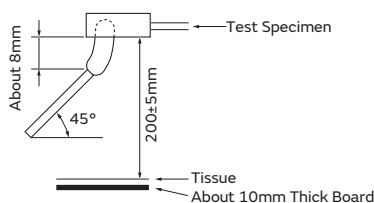
No.	Item	Specifications	Test Method															
15	Robustness of Terminations	Lead wire should not be cut off. Capacitor should not be broken.	<p>As shown in the figure at right, fix the body of the capacitor and apply a tensile weight gradually to each lead wire in the radial direction of the capacitor up to 10N and keep it for 10±1s.</p> 															
	Bending		<p>Each lead wire should be subjected to 5N of weight and bent 90° at the point of egress, in one direction, then returned to its original position and bent 90° in the opposite direction at the rate of one bend in 2 to 3s.</p>															
16	Active Flammability	The cheesecloth should not catch on fire.	<p>The capacitor should be individually wrapped in at least one, but not more than two, complete layers of cheesecloth. The capacitor should be subjected to 20 discharges. The interval between successive discharges should be 5s. The UAC should be maintained for 2min after the last discharge.</p>  <p> C1,2 : 1μF±10% C3 : 0.033μF±5% 10kV L1 to 4 : 1.5mH±20% 16A Rod core choke Ct : 3μF±5% 10kV R : 100Ω±2% Cx : Capacitor under test UAC : UR±5% F : Fuse, Rated 10A UR : Rated Voltage Ut : Voltage applied to Ct </p> 															
17	Passive Flammability	The burning time should not exceed 30s. The tissue paper should not ignite.	<p>The capacitor under test should be held in the flame in the position that best promotes burning. Each specimen should only be exposed once to the flame. Time of exposure to flame: 30s.</p> <p> Length of flame : 12±1mm Gas burner : Length 35mm min. : Inside Dia. 0.5±0.1mm : Outside Dia. 0.9mm max. Gas : Butane gas Purity 95% min. </p> 															
18	Appearance	No marked defect	<p>The capacitor should be subjected to 1000 temperature cycles.</p> <table border="1"> <thead> <tr> <th>Step</th> <th>Temperature (°C)</th> <th>Time (min.)</th> </tr> </thead> <tbody> <tr> <td>1</td> <td>-55+0/-3</td> <td>30</td> </tr> <tr> <td>2</td> <td>Room temp.</td> <td>3</td> </tr> <tr> <td>3</td> <td>125+3/-0</td> <td>30</td> </tr> <tr> <td>4</td> <td>Room temp.</td> <td>3</td> </tr> </tbody> </table> <p style="text-align: right;">Cycle time: 1000 cycles</p> <p>Pre-treatment: Capacitor should be stored at 125±3°C for 1h, then placed at room condition* for 24±2h. Post-treatment: Capacitor should be stored for 24±2h at room condition*.</p>	Step	Temperature (°C)	Time (min.)	1	-55+0/-3	30	2	Room temp.	3	3	125+3/-0	30	4	Room temp.	3
	Step	Temperature (°C)		Time (min.)														
	1	-55+0/-3		30														
	2	Room temp.		3														
	3	125+3/-0		30														
4	Room temp.	3																
Capacitance Change	<table border="1"> <thead> <tr> <th>Char.</th> <th>Capacitance Change</th> </tr> </thead> <tbody> <tr> <td>B</td> <td>Within ±10%</td> </tr> <tr> <td>E</td> <td>Within ±20%</td> </tr> </tbody> </table>	Char.	Capacitance Change	B	Within ±10%	E	Within ±20%											
Char.	Capacitance Change																	
B	Within ±10%																	
E	Within ±20%																	
D.F.	<table border="1"> <thead> <tr> <th>Char.</th> <th>Specifications</th> </tr> </thead> <tbody> <tr> <td>B, E</td> <td>D.F. ≤5.0%</td> </tr> </tbody> </table>	Char.	Specifications	B, E	D.F. ≤5.0%													
Char.	Specifications																	
B, E	D.F. ≤5.0%																	
I.R.	3000MΩ min.																	
Dielectric Strength	Per Item 6																	

* "Room condition" Temperature: 15 to 35°C, Relative humidity: 45 to 75%, Atmosphere pressure: 86 to 106kPa

Continued on the following page. ↗

Type KJ Specifications and Test Methods

Continued from the preceding page. ↘

No.	Item	Specifications	Test Method									
19	High Temperature Exposure (Storage)	Capacitance Change Within $\pm 20\%$	Set the capacitor for 1000 \pm 12h at 150 \pm 3°C. Pre-treatment: Capacitor should be stored at 125 \pm 3°C for 1h, then placed at room condition* for 24 \pm 2h. Post-treatment: Capacitor should be stored for 24 \pm 2h at room condition*.									
	D.F.	<table border="1"> <tr> <th>Char.</th> <th>Specifications</th> </tr> <tr> <td>B, E</td> <td>D.F. $\leq 5.0\%$</td> </tr> </table>		Char.	Specifications	B, E	D.F. $\leq 5.0\%$					
	Char.	Specifications										
B, E	D.F. $\leq 5.0\%$											
I.R.	1000M Ω min.											
20	Thermal Shock	Appearance No marked defect except color change of outer coating.	The capacitor should be subjected to 300 cycles. <table border="1"> <thead> <tr> <th>Step</th> <th>Temperature (°C)</th> <th>Time (min.)</th> </tr> </thead> <tbody> <tr> <td>1</td> <td>-55+0/-3</td> <td>15\pm3</td> </tr> <tr> <td>2</td> <td>125+3/-0</td> <td>15\pm3</td> </tr> </tbody> </table> Pre-treatment: Capacitor should be stored at 125 \pm 3°C for 1h, then placed at room condition* for 24 \pm 2h. Post-treatment: Capacitor should be stored for 24 \pm 2h at room condition*.	Step	Temperature (°C)	Time (min.)	1	-55+0/-3	15 \pm 3	2	125+3/-0	15 \pm 3
	Step	Temperature (°C)		Time (min.)								
	1	-55+0/-3		15 \pm 3								
	2	125+3/-0		15 \pm 3								
Capacitance Change	<table border="1"> <tr> <th>Char.</th> <th>Capacitance Change</th> </tr> <tr> <td>B</td> <td>Within $\pm 10\%$</td> </tr> <tr> <td>E</td> <td>Within $\pm 20\%$</td> </tr> </table>	Char.	Capacitance Change	B	Within $\pm 10\%$	E	Within $\pm 20\%$					
Char.	Capacitance Change											
B	Within $\pm 10\%$											
E	Within $\pm 20\%$											
D.F.	<table border="1"> <tr> <th>Char.</th> <th>Specifications</th> </tr> <tr> <td>B, E</td> <td>D.F. $\leq 5.0\%$</td> </tr> </table>	Char.	Specifications	B, E	D.F. $\leq 5.0\%$							
Char.	Specifications											
B, E	D.F. $\leq 5.0\%$											
I.R.	3000M Ω min.											
21	Resistance to Solvents	Appearance No marked defect	Per MIL-STD-202 Method 215 Solvent 1: 1 part (by volume) of isopropyl alcohol 3 parts (by volume) of mineral spirits Solvent 2: Terpene defluxer Solvent 3: 42 parts (by volume) of water 1 part (by volume) of propylene glycol monomethyl ether 1 part (by volume) of monoethanolamine									
	Capacitance Change	<table border="1"> <tr> <th>Char.</th> <th>Capacitance Change</th> </tr> <tr> <td>B</td> <td>Within $\pm 10\%$</td> </tr> <tr> <td>E</td> <td>Within $\pm 20\%$</td> </tr> </table>		Char.	Capacitance Change	B	Within $\pm 10\%$	E	Within $\pm 20\%$			
	Char.	Capacitance Change										
	B	Within $\pm 10\%$										
E	Within $\pm 20\%$											
D.F.	<table border="1"> <tr> <th>Char.</th> <th>Specifications</th> </tr> <tr> <td>B, E</td> <td>D.F. $\leq 5.0\%$</td> </tr> </table>	Char.	Specifications	B, E	D.F. $\leq 5.0\%$							
Char.	Specifications											
B, E	D.F. $\leq 5.0\%$											
I.R.	3000M Ω min.											
22	Biased Humidity	Appearance No marked defect	Apply the rated voltage and DC1.3+0.2/-0V (add 6.8k Ω resistor) at 85 \pm 3°C and 80 to 85% humidity for 1000 \pm 12h. Pre-treatment: Capacitor should be stored at 125 \pm 3°C for 1h, then placed at room condition* for 24 \pm 2h. Post-treatment: Capacitor should be stored for 24 \pm 2h at room condition*.									
	Capacitance Change	<table border="1"> <tr> <th>Char.</th> <th>Capacitance Change</th> </tr> <tr> <td>B</td> <td>Within $\pm 10\%$</td> </tr> <tr> <td>E</td> <td>Within $\pm 15\%$</td> </tr> </table>		Char.	Capacitance Change	B	Within $\pm 10\%$	E	Within $\pm 15\%$			
	Char.	Capacitance Change										
	B	Within $\pm 10\%$										
E	Within $\pm 15\%$											
D.F.	<table border="1"> <tr> <th>Char.</th> <th>Specifications</th> </tr> <tr> <td>B, E</td> <td>D.F. $\leq 5.0\%$</td> </tr> </table>	Char.	Specifications	B, E	D.F. $\leq 5.0\%$							
Char.	Specifications											
B, E	D.F. $\leq 5.0\%$											
I.R.	3000M Ω min.											
23	Moisture Resistance	Appearance No marked defect	Apply 24h of heat (25 to 65°C) and humidity (80 to 98%) treatment shown below, 10 consecutive times. Pre-treatment: Capacitor should be stored at 125 \pm 3°C for 1h, then placed at room condition* for 24 \pm 2h. Post-treatment: Capacitor should be stored for 24 \pm 2h at room condition*.									
	Capacitance Change	<table border="1"> <tr> <th>Char.</th> <th>Capacitance Change</th> </tr> <tr> <td>B</td> <td>Within $\pm 10\%$</td> </tr> <tr> <td>E</td> <td>Within $\pm 20\%$</td> </tr> </table>		Char.	Capacitance Change	B	Within $\pm 10\%$	E	Within $\pm 20\%$			
	Char.	Capacitance Change										
	B	Within $\pm 10\%$										
E	Within $\pm 20\%$											
D.F.	<table border="1"> <tr> <th>Char.</th> <th>Specifications</th> </tr> <tr> <td>B, E</td> <td>D.F. $\leq 5.0\%$</td> </tr> </table>	Char.	Specifications	B, E	D.F. $\leq 5.0\%$							
Char.	Specifications											
B, E	D.F. $\leq 5.0\%$											
I.R.	3000M Ω min.											

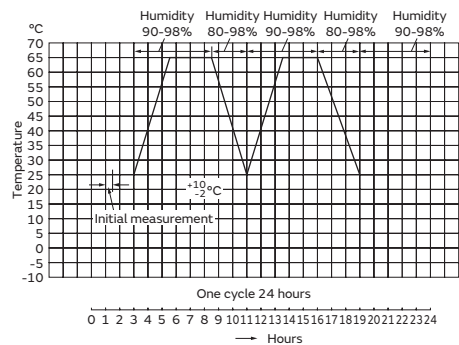

* "Room condition" Temperature: 15 to 35°C, Relative humidity: 45 to 75%, Atmosphere pressure: 86 to 106kPa

Characteristics Data (Typical Example)

Capacitance - Temperature Characteristics

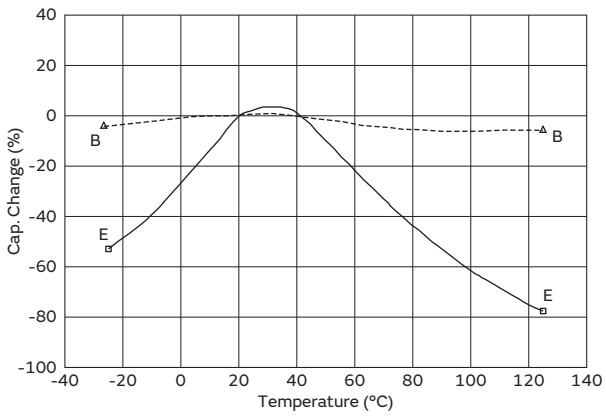

Insertion Loss - Frequency Characteristics

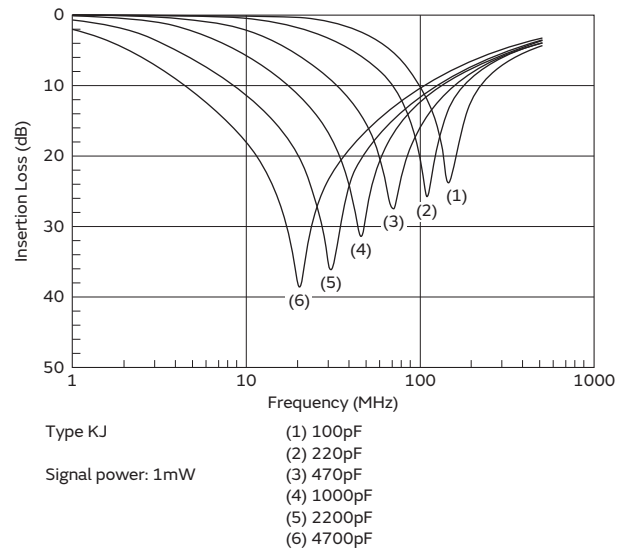

Leakage Current Characteristics

Type KJ (B char.)

AC voltage : 60Hz
 Temperature: 25°C

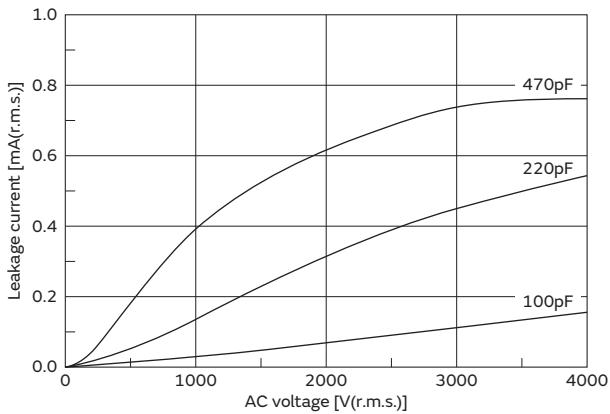

Type KJ (E char.)

AC voltage : 60Hz
 Temperature: 25°C

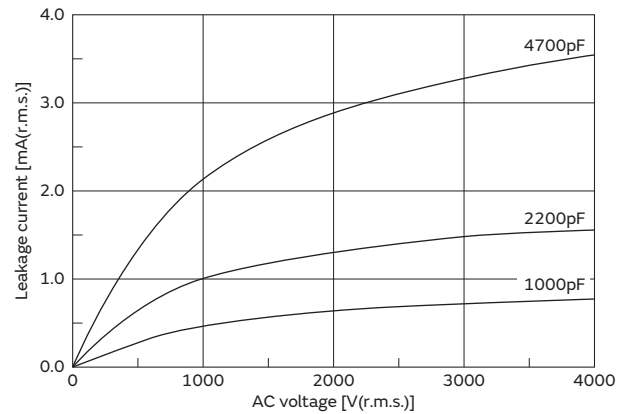

Packaging

Taping Specifications

- 15mm pitch / lead spacing 7.5mm taping
 Vertical crimp type
 (Lead Code: N3)

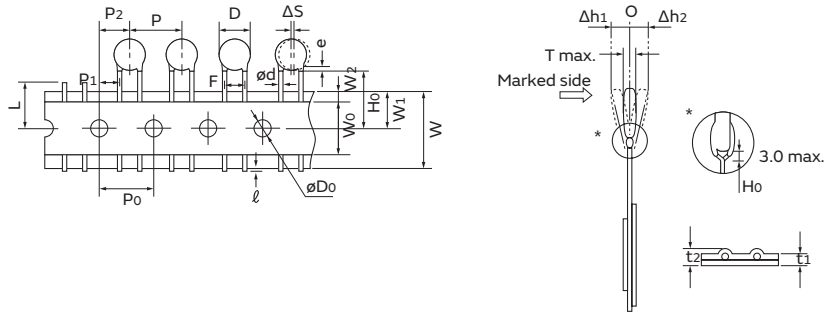

Item	Code	N3
Pitch of component	P	15.0±2.0
Pitch of sprocket hole	P ₀	15.0±0.3
Lead spacing	F	7.5±1.0
Length from hole center to component center	P ₂	7.5±1.5
Length from hole center to lead	P ₁	3.75±1.0
Body diameter	D	See the individual product specifications.
Deviation along tape, left or right	ΔS	0±2.0
Carrier tape width	W	18.0±0.5
Position of sprocket hole	W ₁	9.0±0.5
Lead distance between reference and bottom planes	H ₀	18.0 ^{+2.0} ₀
Protrusion length	ℓ	+0.5 to -1.0
Diameter of sprocket hole	øD ₀	4.0±0.1
Lead diameter	ød	0.6±0.05
Total tape thickness	t ₁	0.6±0.3
Total thickness, tape and lead wire	t ₂	1.5 max.
Body thickness	T	7.0 max.
Portion to cut in case of defect	L	11.0 ⁰ _{-1.0}
Hold down tape width	W ₀	11.5 min.
Hold down tape position	W ₂	1.5±1.5
Coating extension on lead	e	Up to the end of crimp
Deviation across tape, front	Δh ₁	2.0 max.
Deviation across tape, rear	Δh ₂	

(in mm)

Packaging Styles

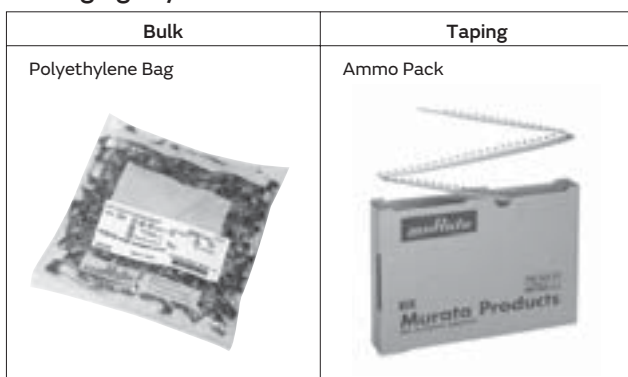

Minimum Quantity (Order in Sets Only)

Body Dia. D (mm)	[Bulk] (pcs./Bag)	
	Lead Code A3 Long	Lead Code B3 Short
7 to 10	250	500
12	200	250

[Taping]

Lead Code: N3
 700pcs./Ammo Pack

⚠Caution

⚠Caution (Rating)

1. Operating Voltage

When DC-rated capacitors are to be used in AC or ripple current circuits, be sure to maintain the V_{p-p} value of the applied voltage or the V_{o-p} that contains DC bias within the rated voltage range.

When the voltage is applied to the circuit, starting or stopping may generate irregular voltage for a transit period because of resonance or switching. Be sure to use a capacitor with a rated voltage range that includes these irregular voltages.

Voltage	DC Voltage	DC+AC Voltage	AC Voltage	Pulse Voltage (1)	Pulse Voltage (2)
Positional Measurement					

2. Operating Temperature and Self-generated Heat

Keep the surface temperature of a capacitor below the upper limit of its rated operating temperature range. Be sure to take into account the heat generated by the capacitor itself. When the capacitor is used in a high-frequency current, pulse current or similar current, it may have self-generated heat due to dielectric loss. Applied voltage load should be such that self-generated heat is within 20°C under the condition where the capacitor is subjected to an atmospheric temperature of 25°C. When measuring, use a thermocouple of small thermal capacity-K of $\phi 0.1\text{mm}$ under conditions where the capacitor is not affected by radiant heat from other components or wind from surroundings. Excessive heat may lead to deterioration of the capacitor's characteristics and reliability. (Never attempt to perform measurement with the cooling fan running. Otherwise, accurate measurement cannot be ensured.)

3. Test Condition for Withstanding Voltage

(1) Test Equipment

Test equipment for AC withstanding voltage should be used with the performance of the wave similar to 50/60Hz sine wave.

If the distorted sine wave or overload exceeding the specified voltage value is applied, a defect may be caused.

Continued on the following page. ↗

⚠Caution

Continued from the preceding page. ↘

(2) Voltage Applied Method

When the withstanding voltage is applied, the capacitor's lead or terminal should be firmly connected to the output of the withstanding voltage test equipment, and then the voltage should be raised from near zero to the test voltage.

If the test voltage without the raise from near zero voltage would be applied directly to capacitor, test voltage should be applied with the zero cross.* At the end of the test time, the test voltage should be reduced to near zero, and then capacitor's lead or terminal should be taken off the output of the withstanding voltage test equipment.

If the test voltage without the raise from near zero voltage would be applied directly to capacitor, the surge voltage may rise, and therefore, a defect may be caused.

*ZERO CROSS is the point where voltage sine wave passes 0V. See the figure at right.

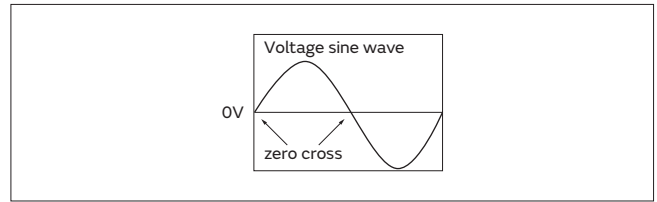

4. Fail-Safe

When the capacitor is broken, failure may result in a short circuit. Be sure to provide an appropriate fail-safe function like a fuse on your product if failure could result in an electric shock, fire or fuming.

FAILURE TO FOLLOW THE ABOVE CAUTIONS MAY RESULT, WORST CASE, IN A SHORT CIRCUIT AND CAUSE FUMING OR PARTIAL DISPERSION WHEN THE PRODUCT IS USED.

⚠️Caution

⚠️Caution (Storage and Operating Condition)

Operating and Storage Environment

The insulating coating of capacitors does not form a perfect seal; therefore, do not use or store capacitors in a corrosive atmosphere, especially where chloride gas, sulfide gas, acid, alkali, salt or the like are present. Also, avoid exposure to moisture. Before cleaning, bonding, or molding this product, verify that these processes do not affect product quality by testing the performance of a cleaned, bonded or molded product in the intended equipment. Store the capacitors where the temperature and relative humidity do not exceed -10 to 40 degrees centigrade and 15 to 85%.

Use capacitors within 6 months after delivery.
Check the solderability after 6 months or more.

FAILURE TO FOLLOW THE ABOVE CAUTIONS MAY RESULT, WORST CASE, IN A SHORT CIRCUIT AND CAUSE FUMING OR PARTIAL DISPERSION WHEN THE PRODUCT IS USED.

⚠️Caution (Soldering and Mounting)

1. Vibration and Impact

Do not expose a capacitor or its lead wires to excessive shock or vibration during use. Excessive shock or vibration may cause fatigue destruction of lead wires mounted on the circuit board. Please take measures to hold a capacitor on the circuit boards by adhesive, molding resin or another coating. Please confirm there is no influence of holding measures on the product with the intended equipment.

2. Soldering

When soldering this product to a PCB/PWB, do not exceed the solder heat resistance specifications of the capacitor. Subjecting this product to excessive heating could melt the internal junction solder and may result in thermal shocks that can crack the ceramic element. Soldering the capacitor with a soldering iron should be performed in the following conditions.
Temperature of iron-tip: 400 degrees C. max.
Soldering iron wattage: 50W max.
Soldering time: 3.5 sec. max.

3. Bonding, Resin Molding and Coating

For bonding, molding or coating this product, verify that these processes do not affect the quality of the capacitor by testing the performance of the bonded, molded or coated product in the intended equipment. When the amount of applications, dryness/hardening conditions of adhesives and molding resins containing organic solvents (ethyl acetate, methyl ethyl ketone, toluene, etc.) are unsuitable, the outer coating resin of a capacitor is damaged by the organic solvents and it may result, worst case, in a short circuit. The variation in thickness of adhesive, molding resin or coating may cause outer coating resin cracking and/or ceramic element cracking of a capacitor in a temperature cycling.

4. Treatment after Bonding, Resin Molding and Coating

When the outer coating is hot (over 100 degrees C.) after soldering, it becomes soft and fragile. Therefore, please be careful not to give it mechanical stress.

FAILURE TO FOLLOW THE ABOVE CAUTIONS MAY RESULT, WORST CASE, IN A SHORT CIRCUIT AND CAUSE FUMING OR PARTIAL DISPERSION WHEN THE PRODUCT IS USED.

⚠️Caution (Handling)

Vibration and Impact

Do not expose a capacitor or its lead wires to excessive shock or vibration during use. Excessive shock or vibration may cause fatigue destruction of lead wires mounted on the circuit board. Please take measures to hold a capacitor on the circuit boards by adhesive, molding resin or another coating.

Please confirm there is no influence of holding measures on the product with the intended equipment.

FAILURE TO FOLLOW THE ABOVE CAUTIONS MAY RESULT, WORST CASE, IN A SHORT CIRCUIT AND CAUSE FUMING OR PARTIAL DISPERSION WHEN THE PRODUCT IS USED.

Notice

Notice (Soldering and Mounting)

Cleaning (ultrasonic cleaning)

To perform ultrasonic cleaning, observe the following conditions.

Rinse bath capacity: Output of 20 watts per liter or less.

Rinsing time: 5min maximum.

Do not vibrate the PCB/PWB directly.

Excessive ultrasonic cleaning may lead to fatigue destruction of the lead wires.

Notice (Rating)

1. Capacitance Change of Capacitors

Capacitors have an aging characteristic, whereby the capacitor continually decreases its capacitance slightly if the capacitor is left on for a long time. Moreover, capacitance might change greatly depending on the surrounding temperature or an applied voltage. Therefore, it is not likely to be suitable for use in a constant time circuit.

Please contact us if you need detailed information.

2. Performance Check by Equipment

Before using a capacitor, check that there is no problem in the equipment's performance and the specifications.

Generally speaking, CLASS 2 ceramic capacitors have voltage dependence characteristics and temperature dependence characteristics in capacitance. Therefore, the capacitance value may change depending on the operating condition in the equipment. Therefore, be sure to confirm the apparatus performance of receiving influence in the capacitance value change of a capacitor, such as leakage current and noise suppression characteristic.

Moreover, check the surge-proof ability of a capacitor in the equipment, if needed, because the surge voltage may exceed specific value by the inductance of the circuit.

Lead Type Disc Ceramic Capacitors (Safety Certified)/ Resin Molding SMD Type Ceramic Capacitors (Safety Certified) ISO9000 Certifications

Manufacturing plants that produce the products in this catalog have obtained the ISO9000 quality system certificate.

Plant	Applied Standard
Murata Electronics (Thailand), Ltd.	ISO9001

Global Locations

For details please visit www.murata.com



⚠ Note

1 Export Control

For customers outside Japan:

No Murata products should be used or sold, through any channels, for use in the design, development, production, utilization, maintenance or operation of, or otherwise contribution to (1) any weapons (Weapons of Mass Destruction [nuclear, chemical or biological weapons or missiles] or conventional weapons) or (2) goods or systems specially designed or intended for military end-use or utilization by military end-users.

For customers in Japan:

For products which are controlled items subject to the "Foreign Exchange and Foreign Trade Law" of Japan, the export license specified by the law is required for export.

2 Please contact our sales representatives or product engineers before using the products in this catalog for the applications listed below, which require especially high reliability for the prevention of defects which might directly damage a third party's life, body or property, or when one of our products is intended for use in applications other than those specified in this catalog.

- ① Aircraft equipment
- ② Aerospace equipment
- ③ Undersea equipment
- ④ Power plant equipment
- ⑤ Medical equipment
- ⑥ Transportation equipment (vehicles, trains, ships, etc.)
- ⑦ Traffic signal equipment
- ⑧ Disaster prevention / crime prevention equipment
- ⑨ Data-processing equipment
- ⑩ Application of similar complexity and/or reliability requirements to the applications listed above

3 Product specifications in this catalog are as of August 2018. They are subject to change or our products in it may be discontinued without advance notice. Please check with our sales representatives or product engineers before ordering. If there are any questions, please contact our sales representatives or product engineers.

4 Please read rating and ⚠CAUTION (for storage, operating, rating, soldering, mounting and handling) in this catalog to prevent smoking and/or burning, etc.

5 This catalog has only typical specifications. Therefore, please approve our product specifications or transact the approval sheet for product specifications before ordering.

6 Please note that unless otherwise specified, we shall assume no responsibility whatsoever for any conflict or dispute that may occur in connection with the effect of our and/or a third party's intellectual property rights and other related rights in consideration of your use of our products and/or information described or contained in our catalogs. In this connection, no representation shall be made to the effect that any third parties are authorized to use the rights mentioned above under licenses without our consent.

7 No ozone depleting substances (ODS) under the Montreal Protocol are used in our manufacturing process.

Murata Manufacturing Co., Ltd.

www.murata.com

muRata
INNOVATOR IN ELECTRONICS

Looking for pricing, stock, or lifecycle information?

Click below to explore more details on WIN SOURCE:

- ⊖ [View DE2E3KY102MN2AM01F on WIN SOURCE](#)
- ⊖ [Murata Electronics North America Information](#)

Optimize Your Supply Chain with WIN SOURCE Solutions

- ✓ Global Sourcing Solution
- ✓ Obsolete Management
- ✓ Cost Control Management
- ✓ Shortage Management
- ✓ Alternative Solution
- ✓ Excess Inventory Management