



**THE DATASHEET OF
CNY17F3TVM**



6-Pin DIP High BV_{CEO} Phototransistor Optocouplers

CNY17 Series, MOC8106M

Description

The CNY17XM, CNY17FXM, and MOC8106M devices consist of a gallium arsenide infrared emitting diode coupled with an NPN phototransistor in a dual in-line package.

Features

- High BV_{CEO} : 70 V Minimum (CNY17XM, CNY17FXM, MOC8106M)
- Closely Matched Current Transfer Ratio (CTR) Minimizes Unit-to-Unit Variation
- Current Transfer Ratio In Select Groups
- Very Low Coupled Capacitance Along With No Chip-to-Pin 6 Base Connection for Minimum Noise Susceptibility (CNY17FXM, MOC8106M)
- Safety and Regulatory Approvals:
 - ◆ UL1577, 4,170 VAC_{RMS} for 1 Minute
 - ◆ DIN-EN/IEC60747-5-5, 850 V Peak Working Insulation Voltage

Applications

- Power Supply Regulators
- Digital Logic Inputs
- Microprocessor Inputs
- Appliance Sensor Systems
- Industrial Controls

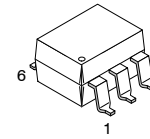

PDIP6
CASE 646BY

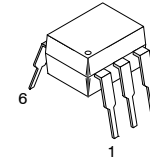

PDIP6
CASE 646BX

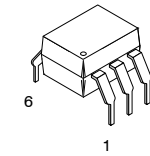

PDIP6
CASE 646BZ

MARKING DIAGRAM

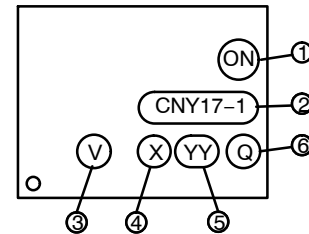

1. ON = onsemi Logo
2. CNY17 = Device Number
3. V = DIN EN/IEC60747-5-5 Option (only appears on component ordered with this option)
4. X = One-Digit Year Code
5. YY = Digit Work Week
6. Q = Assembly Package Code

ORDERING INFORMATION

See detailed ordering and shipping information on page 8 of this data sheet.

CNY17 Series, MOC8106M

SCHEMATICS

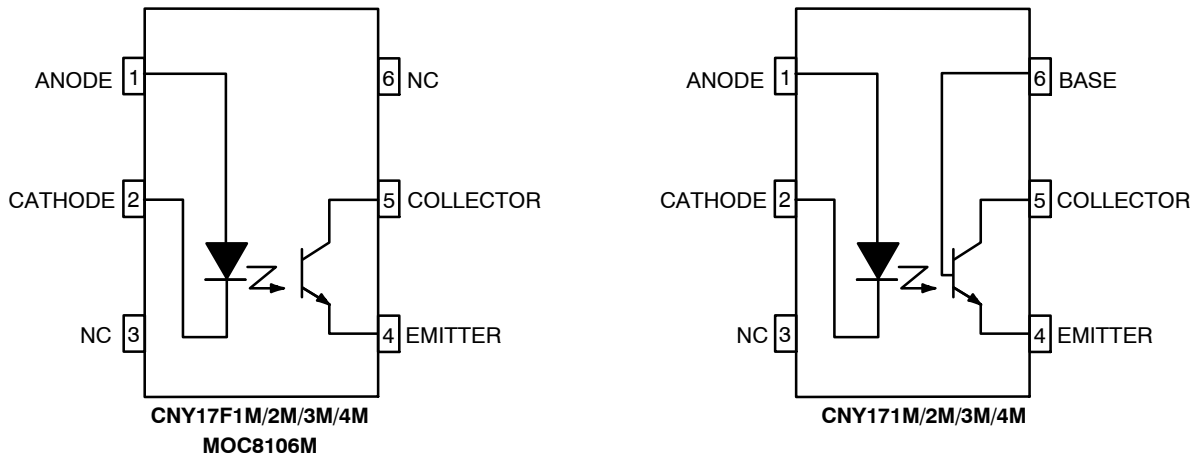

Figure 1. Schematics

SAFETY AND INSULATION RATINGS

As per DIN EN/IEC 60747-5-5, this optocoupler is suitable for “safe electrical insulation” only within the safety limit data. Compliance with the safety ratings shall be ensured by means of protective circuits.

| Parameter | | Characteristics |
|---|------------------------|-----------------|
| Installation Classifications per DIN VDE 0110/1.89 Table 1, For Rated Mains Voltage | < 150 V _{RMS} | I-IV |
| | < 300 V _{RMS} | I-IV |
| Climatic Classification | | 55/100/21 |
| Pollution Degree (DIN VDE 0110/1.89) | | 2 |
| Comparative Tracking Index | | 175 |

| Symbol | Parameter | Value | Unit |
|------------------------|--|-------------------|-------------------|
| V _{PR} | Input-to-Output Test Voltage, Method A, V _{IORM} × 1.6 = V _{PR} , Type and Sample Test with t _m = 10 s, Partial Discharge < 5 pC | 1360 | V _{peak} |
| | Input-to-Output Test Voltage, Method B, V _{IORM} × 1.875 = V _{PR} , 100% Production Test with t _m = 1 s, Partial Discharge < 5 pC | 1594 | V _{peak} |
| V _{IORM} | Maximum Working Insulation Voltage | 850 | V _{peak} |
| V _{IOTM} | Highest Allowable Over-Voltage | 6000 | V _{peak} |
| | External Creepage | ≥ 7 | mm |
| | External Clearance | ≥ 7 | mm |
| | External Clearance (for Option TV, 0.4" Lead Spacing) | ≥ 10 | mm |
| DTI | Distance Through Insulation (Insulation Thickness) | ≥ 0.5 | mm |
| T _S | Case Temperature (Note 1) | 175 | °C |
| I _{S, INPUT} | Input Current (Note 1) | 350 | mA |
| P _{S, OUTPUT} | Output Power (Note 1) | 800 | mW |
| R _{IO} | Insulation Resistance at T _S , V _{IO} = 500 V (Note 1) | > 10 ⁹ | Ω |

1. Safety limit values – maximum values allowed in the event of a failure.

CNY17 Series, MOC8106M

ABSOLUTE MAXIMUM RATINGS

| Symbol | Parameter | Value | Unit |
|---------------------|--|--------------------|-------|
| TOTAL DEVICE | | | |
| T_{STG} | Storage Temperature | -40 to +125 | °C |
| T_A | Ambient Operating Temperature | -40 to +100 | °C |
| T_J | Junction Temperature | -40 to +125 | °C |
| T_{SOL} | Lead Solder Temperature | 260 for 10 seconds | °C |
| P_D | Total Device Power Dissipation @ 25°C (LED plus detector) Derate Linearly From 25°C | 270 | mW |
| | | 2.94 | mW/°C |
| EMITTER | | | |
| I_F | Continuous Forward Current | 60 | mA |
| V_R | Reverse Voltage | 6 | V |
| I_F (pk) | Forward Current – Peak (1 μ s pulse, 300 pps) | 1.5 | A |
| P_D | LED Power Dissipation 25°C Ambient Derate Linearly From 25°C | 120 | mW |
| | | 1.41 | mW/°C |
| DETECTOR | | | |
| I_C | Continuous Collector Current | 50 | mA |
| V_{CEO} | Collector–Emitter Voltage | 70 | V |
| V_{ECO} | Emitter Collector Voltage | 7 | V |
| P_D | Detector Power Dissipation @ 25°C Derate Linearly from 25°C | 150 | mW |
| | | 1.76 | mW/°C |

Stresses exceeding those listed in the Maximum Ratings table may damage the device. If any of these limits are exceeded, device functionality should not be assumed, damage may occur and reliability may be affected.

CNY17 Series, MOC8106M

ELECTRICAL CHARACTERISTICS

(T_A = 25°C unless otherwise specified)

INDIVIDUAL COMPONENT CHARACTERISTICS

| Symbol | Parameter | Test Conditions | Device | Min. | Typ. | Max. | Unit |
|----------------|-------------------------|-----------------------------------|-------------------|------|-------|------|------|
| EMITTER | | | | | | | |
| V _F | Input Forward Voltage | I _F = 10 mA | All Devices | 1.0 | 1.15 | 1.50 | V |
| | | I _F = 60 mA | CNY17XM, CNY17FXM | 1.0 | 1.35 | 1.65 | V |
| C _J | Capacitance | V _F = 0 V, f = 1.0 MHz | All Devices | – | 18 | – | pF |
| I _R | Reverse Leakage Current | V _R = 6 V | All Devices | – | 0.001 | 10 | μA |

DETECTOR

| | | | | | | | |
|-------------------|---|---|-------------|----|-----|----|----|
| BV _{CEO} | Breakdown Voltage Collector-to-Emitter | I _C = 1 mA, I _F = 0 | All Devices | 70 | 100 | – | V |
| BV _{CBO} | Collector-to-Base | I _C = 10 μA, I _F = 0 | CNY17XM | 70 | 120 | – | V |
| BV _{ECO} | Emitter-to-Collector | I _E = 100 μA, I _F = 0 | All Devices | 7 | 10 | – | V |
| I _{CEO} | Leakage Current Collector-to-Emitter | V _{CE} = 10 V, I _F = 0 | All Devices | – | 1 | 50 | nA |
| I _{CBO} | Collector-to-Base | V _{CB} = 10 V, I _F = 0 | CNY17XM | – | – | 20 | nA |
| C _{CE} | Capacitance Collector-to-Emitter | V _{CE} = 0, f = 1 MHz | All Devices | – | 8 | – | pF |
| C _{CB} | Collector-to-Base | V _{CB} = 0, f = 1 MHz | CNY17XM | – | 20 | – | pF |
| C _{EB} | Emitter-to-Base | V _{EB} = 0, f = 1 MHz | CNY17XM | – | 10 | – | pF |

TRANSFER CHARACTERISTICS

| Symbol | Parameter | Test Conditions | Device | Min. | Typ. | Max. | Unit |
|----------------------|---|---|-------------------|------|------|------|------|
| COUPLED | | | | | | | |
| CTR | Current Transfer Ratio | I _F = 10 mA, V _{CE} = 10 V | MOC8106M | 50 | – | 150 | % |
| | | I _F = 10 mA, V _{CE} = 5 V | CNY171M, CNY17F1M | 40 | – | 80 | % |
| | | I _F = 10 mA, V _{CE} = 5 V | CNY172M, CNY17F2M | 63 | – | 125 | % |
| | | I _F = 10 mA, V _{CE} = 5 V | CNY173M, CNY17F3M | 100 | – | 200 | % |
| | | I _F = 10 mA, V _{CE} = 5 V | CNY174M, CNY17F4M | 160 | – | 320 | % |
| V _{CE(SAT)} | Collector-Emitter Saturation Voltage | I _C = 0.5 mA, I _F = 5 mA | MOC8106M | – | – | 0.4 | V |
| | | I _C = 2.5 mA, I _F = 10 mA | CNY17XM/CNY17FXM | – | – | | |

CNY17 Series, MOC8106M

AC CHARACTERISTICS

| Symbol | Parameter | Test Conditions | Device | Min. | Typ. | Max. | Unit |
|--------|-----------|-----------------|--------|------|------|------|------|
|--------|-----------|-----------------|--------|------|------|------|------|

NON-SATURATED SWITCHING TIME

| | | | | | | | |
|-----------|---------------|---|------------------|---|-----|------|---------------|
| t_{on} | Turn-On Time | $I_C = 2.0 \text{ mA}$, $V_{CC} = 10 \text{ V}$, $R_L = 100 \Omega$ | All Devices | - | 2.0 | 10.0 | μs |
| t_{off} | Turn-Off Time | $I_C = 2.0 \text{ mA}$, $V_{CC} = 10 \text{ V}$, $R_L = 100 \Omega$ | All Devices | - | 3.0 | 10.0 | μs |
| t_d | Delay Time | $I_F = 10 \text{ mA}$, $V_{CC} = 5 \text{ V}$, $R_L = 75 \Omega$ | CNY17XM/CNY17FXM | - | - | 5.6 | μs |
| t_r | Rise Time | $I_F = 10 \text{ mA}$, $V_{CC} = 5 \text{ V}$, $R_L = 75 \Omega$ | CNY17XM/CNY17FXM | - | - | 4.0 | μs |
| t_s | Storage Time | $I_F = 10 \text{ mA}$, $V_{CC} = 5 \text{ V}$, $R_L = 75 \Omega$ | CNY17XM/CNY17FXM | - | - | 4.1 | μs |
| t_f | Fall Time | $I_F = 10 \text{ mA}$, $V_{CC} = 5 \text{ V}$, $R_L = 75 \Omega$ | CNY17XM/CNY17FXM | - | - | 3.5 | μs |

SATURATED SWITCHING TIME

| | | | | | | | |
|-------|--------------|--|-----------------------------------|---|---|------|---------------|
| t_d | Delay Time | $I_F = 20 \text{ mA}$, $V_{CC} = 5 \text{ V}$, $R_L = 1 \text{ k}\Omega$ | CNY171M/F1M | - | - | 5.5 | μs |
| | | $I_F = 10 \text{ mA}$, $V_{CC} = 5 \text{ V}$, $R_L = 1 \text{ k}\Omega$ | CNY172M/3M/4M CNY17F2M/F3M/F4M | - | - | 8.0 | μs |
| t_r | Rise Time | $I_F = 20 \text{ mA}$, $V_{CC} = 5 \text{ V}$, $R_L = 1 \text{ k}\Omega$ | CNY171M/F1M | - | - | 4.0 | μs |
| | | $I_F = 10 \text{ mA}$, $V_{CC} = 5 \text{ V}$, $R_L = 1 \text{ k}\Omega$ | CNY172M/3M/4M CNY17F2M/F3M/F4M | - | - | 6.0 | μs |
| t_s | Storage Time | $I_F = 20 \text{ mA}$, $V_{CC} = 5 \text{ V}$, $R_L = 1 \text{ k}\Omega$ | CNY171M/F1M | - | - | 34.0 | μs |
| | | $I_F = 10 \text{ mA}$, $V_{CC} = 5 \text{ V}$, $R_L = 1 \text{ k}\Omega$ | CNY172M/3M/4M CNY17F2M/F3M/F4M | - | - | 39.0 | μs |
| t_f | Fall Time | $I_F = 20 \text{ mA}$, $V_{CC} = 5 \text{ V}$, $R_L = 1 \text{ k}\Omega$ | CNY171M/F1M | - | - | 20.0 | μs |
| | | $I_F = 10 \text{ mA}$, $V_{CC} = 5 \text{ V}$, $R_L = 1 \text{ k}\Omega$ | CNY172M/3M/4M CNY17F2M/F3M/F4M | - | - | 24.0 | μs |

ISOLATION CHARACTERISTICS

| Symbol | Parameter | Test Conditions | Min. | Typ. | Max. | Unit |
|--------|--------------------------------|--|-----------|------|------|----------------|
| VISO | Input-Output Isolation Voltage | $t = 1 \text{ Minute}$ | 4170 | - | - | $V_{AC_{RMS}}$ |
| CISO | Isolation Capacitance | $V_{I-O} = 0 \text{ V}$, $f = 1 \text{ MHz}$ | - | 0.2 | - | pF |
| RISO | Isolation Resistance | $V_{I-O} = \pm 500 \text{ VDC}$, $T_A = 25^\circ\text{C}$ | 10^{11} | - | - | Ω |

TYPICAL PERFORMANCE CHARACTERISTICS

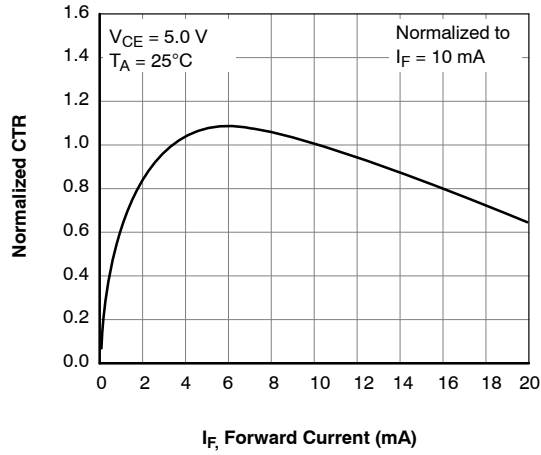

Figure 2. Normalized CTR vs. Forward Current

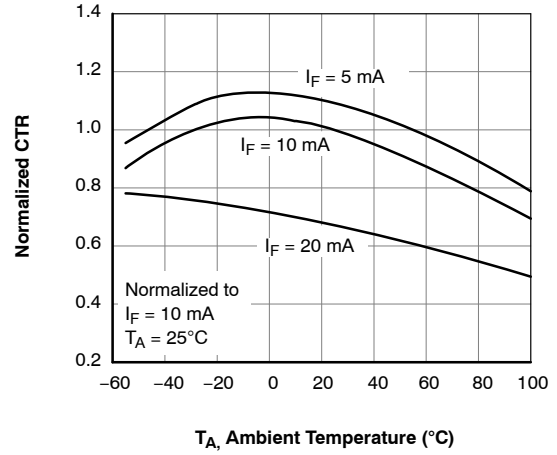

Figure 3. Normalized CTR vs. Ambient Temperature

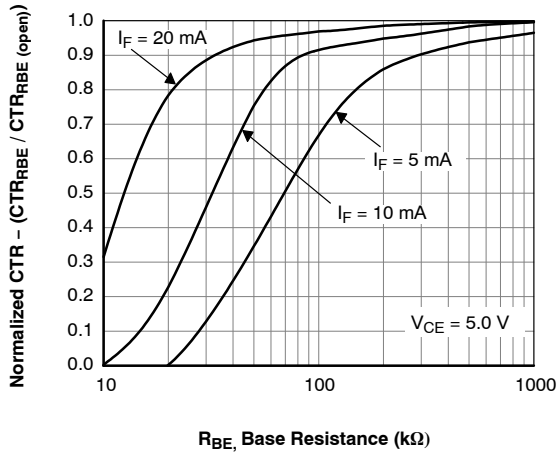

Figure 4. CTR vs. R_{BE} (Unsaturated)

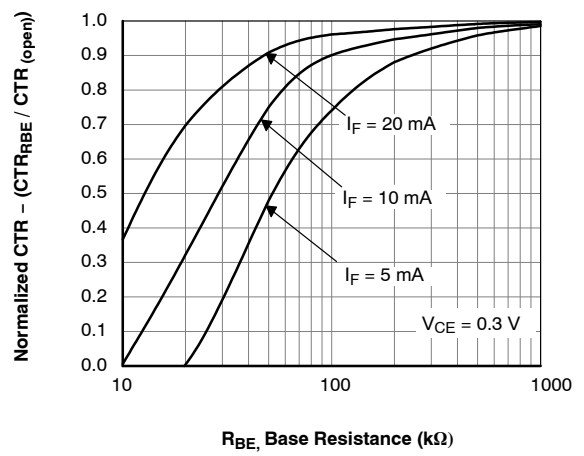

Figure 5. CTR vs. R_{BE} (Saturated)

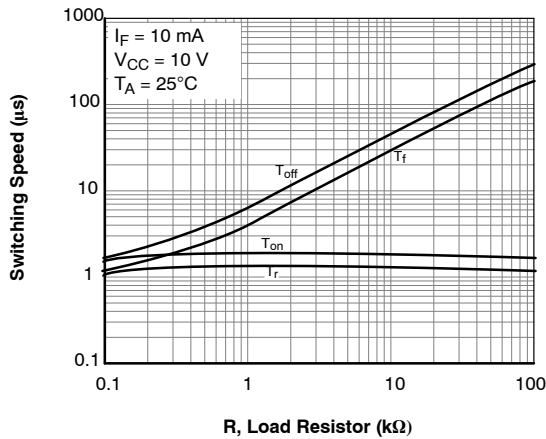

Figure 6. Switching Speed vs. Load Resistor

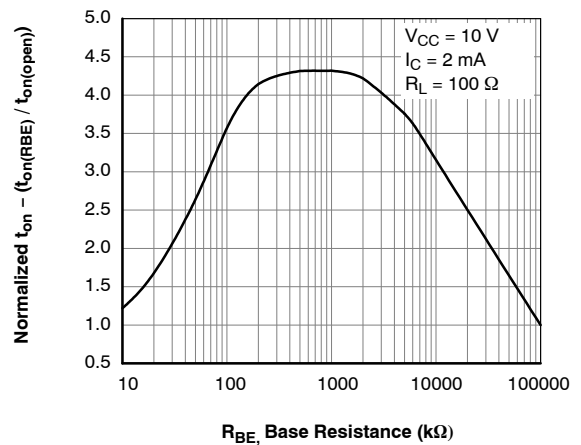

Figure 7. Normalized t_{on} vs. R_{BE}

TYPICAL PERFORMANCE CHARACTERISTICS (Continued)

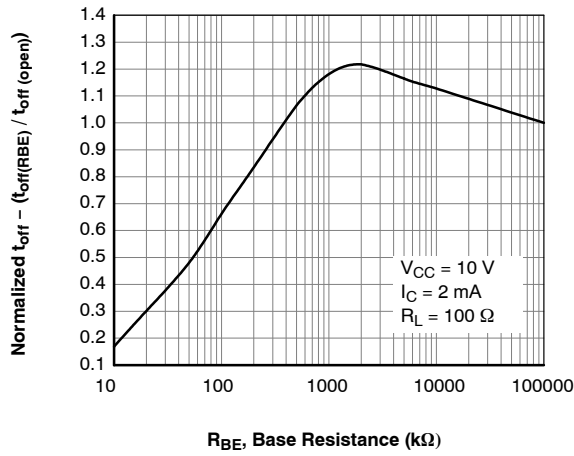

Figure 8. Normalized t_{off} vs. R_{BE}

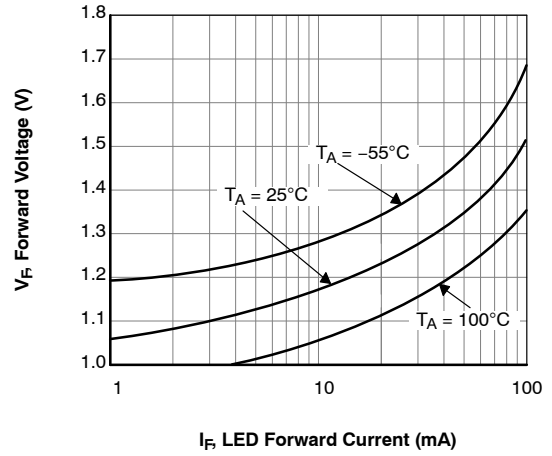

Figure 9. LED Forward Voltage vs. Forward Current

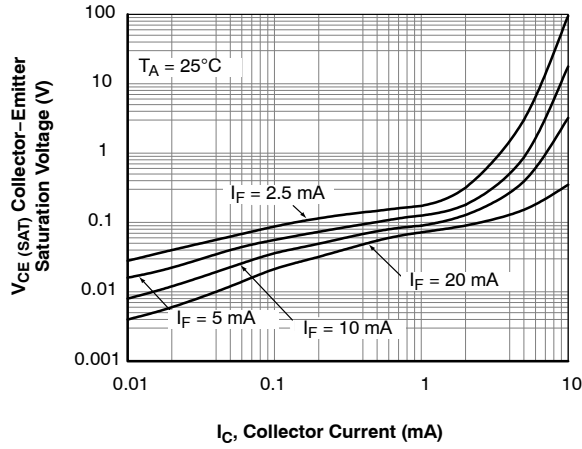

Figure 10. Collector-Emitter Saturation Voltage vs. Collector Current

SWITCHING TEST CIRCUIT AND WAVEFORMS

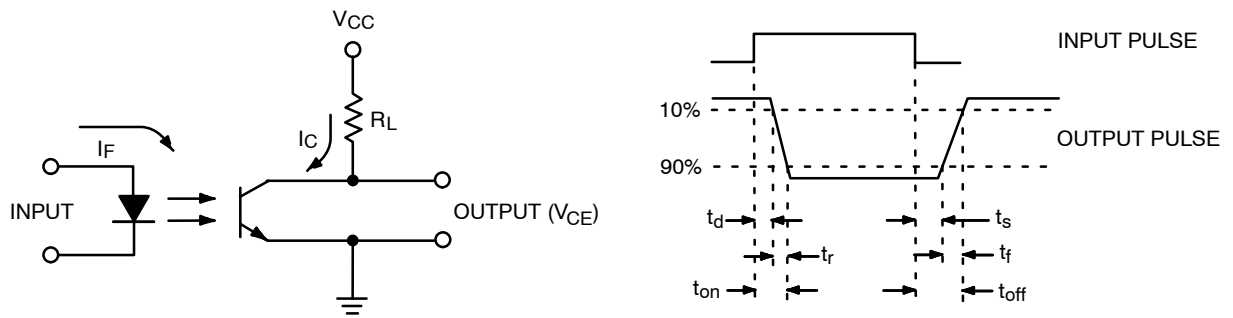

Figure 11. Switching Test Circuit and Waveforms

CNY17 Series, MOC8106M

REFLOW PROFILE

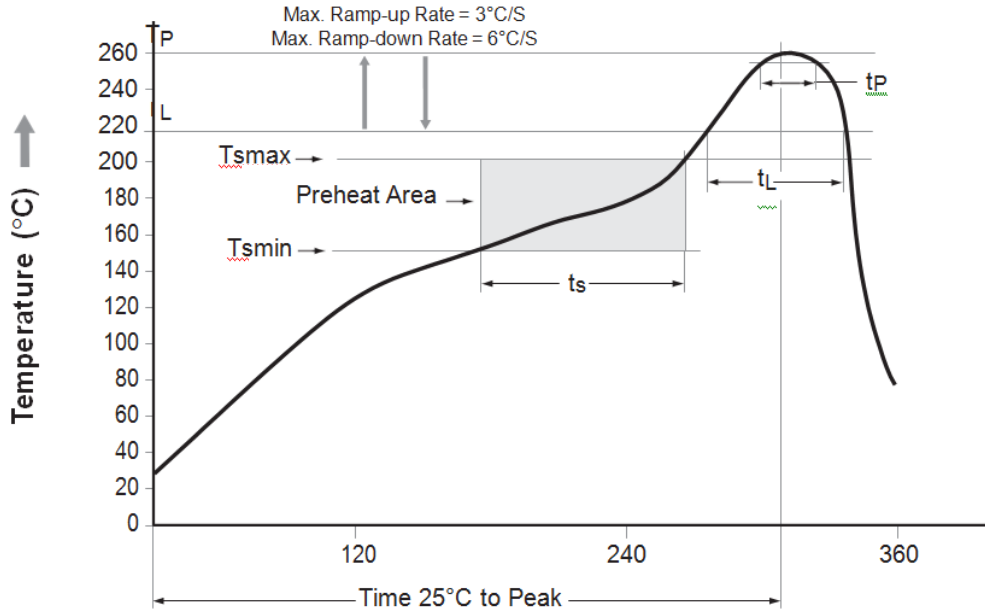

Figure 12. Reflow Profile

| Profile Feature | Pb – Free Assembly Profile |
|---------------------------------|----------------------------|
| Temperature Min. (Tsmín) | 150°C |
| Temperature Max. (Tsmáx) | 200°C |
| Time (ts) from (Tsmín to Tsmáx) | 60–120 seconds |
| Ramp – up Rate (t to tp) | 3°C/second max. |
| Liquidous Temperature (TL) | 217°C |
| Time (tL) Maintained Above (TL) | 60–150 seconds |
| Peak Body Package Temperature | 260°C +0°C / –5°C |
| Time (tp) within 5°C of 260°C | 30 seconds |
| Ramp – down Rate (TP to TL) | 6°C / second max. |
| Time 25°C to Peak Temperature | 8 minutes max. |

Table 1. ORDERING INFORMATION

| Part Number | Package | Packing Method† |
|-------------|--|----------------------------|
| CNY171M | DIP 6–Pin | Tube (50 Units) |
| CNY171SM | SMT 6–Pin (Lead Bend) | Tube (50 Units) |
| CNY171SR2M | SMT 6–Pin (Lead Bend) | Tape and Reel (1000 Units) |
| CNY171TM | DIP 6–Pin, 0.4" Lead Spacing | Tube (50 Units) |
| CNY171VM | DIP 6–Pin, DIN EN/IEC60747–5–5 Option | Tube (50 Units) |
| CNY171SVM | SMT 6–Pin (Lead Bend), DIN EN/IEC60747–5–5 Option | Tube (50 Units) |
| CNY171SR2VM | SMT 6–Pin (Lead Bend), DIN EN/IEC60747–5–5 Option | Tape and Reel (1000 Units) |
| CNY171TVM | DIP 6–Pin, 0.4" Lead Spacing, DIN EN/IEC60747–5–5 Option | Tube (50 Units) |

†For information on tape and reel specifications, including part orientation and tape sizes, please refer to our Tape and Reel Packaging Specification Brochure, BRD8011/D.

2. The product orderable part number system listed in this table also applies to the CNY17FXM product family and the MOC8106M device.

MECHANICAL CASE OUTLINE

PACKAGE DIMENSIONS

ON Semiconductor®



PDIP6 8.51x6.35, 2.54P
CASE 646BX
ISSUE O

DATE 31 JUL 2016



NOTES:

- A) NO STANDARD APPLIES TO THIS PACKAGE.
- B) ALL DIMENSIONS ARE IN MILLIMETERS.
- C) DIMENSIONS ARE EXCLUSIVE OF BURRS, MOLD FLASH, AND TIE BAR EXTRUSION

| | | |
|-------------------------|-------------------------------|--|
| DOCUMENT NUMBER: | 98AON13449G | Electronic versions are uncontrolled except when accessed directly from the Document Repository. Printed versions are uncontrolled except when stamped "CONTROLLED COPY" in red. |
| DESCRIPTION: | PDIP6 8.51X6.35, 2.54P | PAGE 1 OF 1 |

ON Semiconductor and are trademarks of Semiconductor Components Industries, LLC dba ON Semiconductor or its subsidiaries in the United States and/or other countries. ON Semiconductor reserves the right to make changes without further notice to any products herein. ON Semiconductor makes no warranty, representation or guarantee regarding the suitability of its products for any particular purpose, nor does ON Semiconductor assume any liability arising out of the application or use of any product or circuit, and specifically disclaims any and all liability, including without limitation special, consequential or incidental damages. ON Semiconductor does not convey any license under its patent rights nor the rights of others.

MECHANICAL CASE OUTLINE

PACKAGE DIMENSIONS

ON Semiconductor®



PDIP6 8.51x6.35, 2.54P

CASE 646BY

ISSUE A

DATE 15 JUL 2019



NOTES:

1. DIMENSIONING AND TOLERANCING PER ASME Y14.5M, 2009.
2. CONTROLLING DIMENSION: MILLIMETERS
3. DIMENSIONS A, A1, AND L ARE MEASURED WITH THE PACKAGE SEATED.
4. DIMENSIONS D, D1, AND E1 DO NOT INCLUDE MOLD FLASH OR PROTRUSIONS. MOLD FLASH OR PROTRUSIONS ARE NOT TO EXCEED 2.54mm.
5. PACKAGE CONTOUR IS OPTIONAL (ROUNDED OR SQUARE CORNERS).
6. CENTER LINE OF CORNER LEADS ARE LOCATED BY LOCATING THE CENTER OF FEATURE b2 AND b3.

| DIM | MILLIMETERS | | |
|-----|-------------|------|------|
| | MIN. | NOM. | MAX. |
| A | --- | --- | 4.80 |
| A1 | 0.38 | --- | --- |
| A2 | 3.28 | 3.40 | 3.53 |
| A3 | 2.49 REF | | |
| A4 | 1.89 REF | | |
| b | 0.41 | 0.46 | 0.51 |
| b1 | 0.76 | 0.92 | 1.14 |
| b2 | 0.25 | 0.28 | 0.36 |
| b3 | 1.02 | 1.40 | 1.78 |
| b4 | 1.778 REF | | |
| c | 0.20 | 0.25 | 0.30 |
| D | 8.13 | 8.51 | 8.89 |
| D1 | 0.86 REF | | |
| E | 6.10 | 6.35 | 6.60 |
| E1 | 8.43 | 9.17 | 9.90 |
| E2 | 8.13 REF | | |
| e | 2.54 BSC | | |
| L | 0.16 | 0.52 | 0.88 |

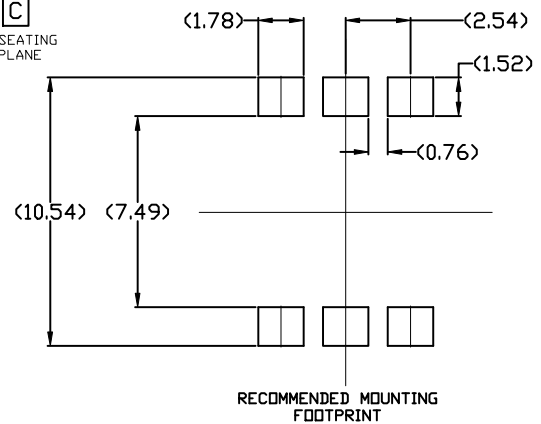
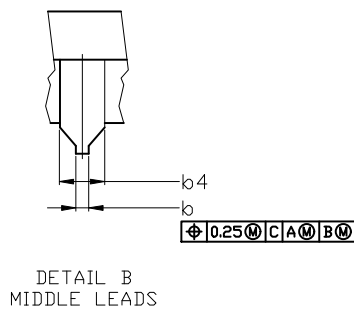
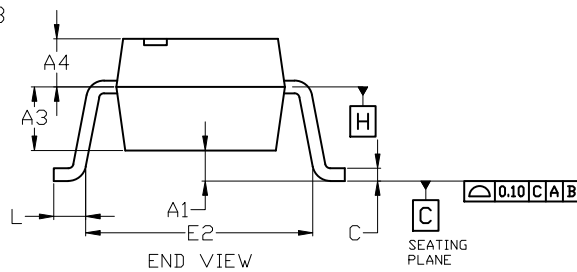

For additional information on our Pb-Free strategy and soldering details, please download the ON Semiconductor Soldering and Mounting Techniques Reference Manual, SOLDERM/D.

| | | |
|-------------------------|-------------------------------|--|
| DOCUMENT NUMBER: | 98AON13450G | Electronic versions are uncontrolled except when accessed directly from the Document Repository. Printed versions are uncontrolled except when stamped "CONTROLLED COPY" in red. |
| DESCRIPTION: | PDIP6 8.51x6.35, 2.54P | PAGE 1 OF 1 |

ON Semiconductor and ON are trademarks of Semiconductor Components Industries, LLC dba ON Semiconductor or its subsidiaries in the United States and/or other countries. ON Semiconductor reserves the right to make changes without further notice to any products herein. ON Semiconductor makes no warranty, representation or guarantee regarding the suitability of its products for any particular purpose, nor does ON Semiconductor assume any liability arising out of the application or use of any product or circuit, and specifically disclaims any and all liability, including without limitation special, consequential or incidental damages. ON Semiconductor does not convey any license under its patent rights nor the rights of others.

MECHANICAL CASE OUTLINE
PACKAGE DIMENSIONS

PDIP6 8.51x6.35, 2.54P
CASE 646BZ
ISSUE O

DATE 31 JUL 2016

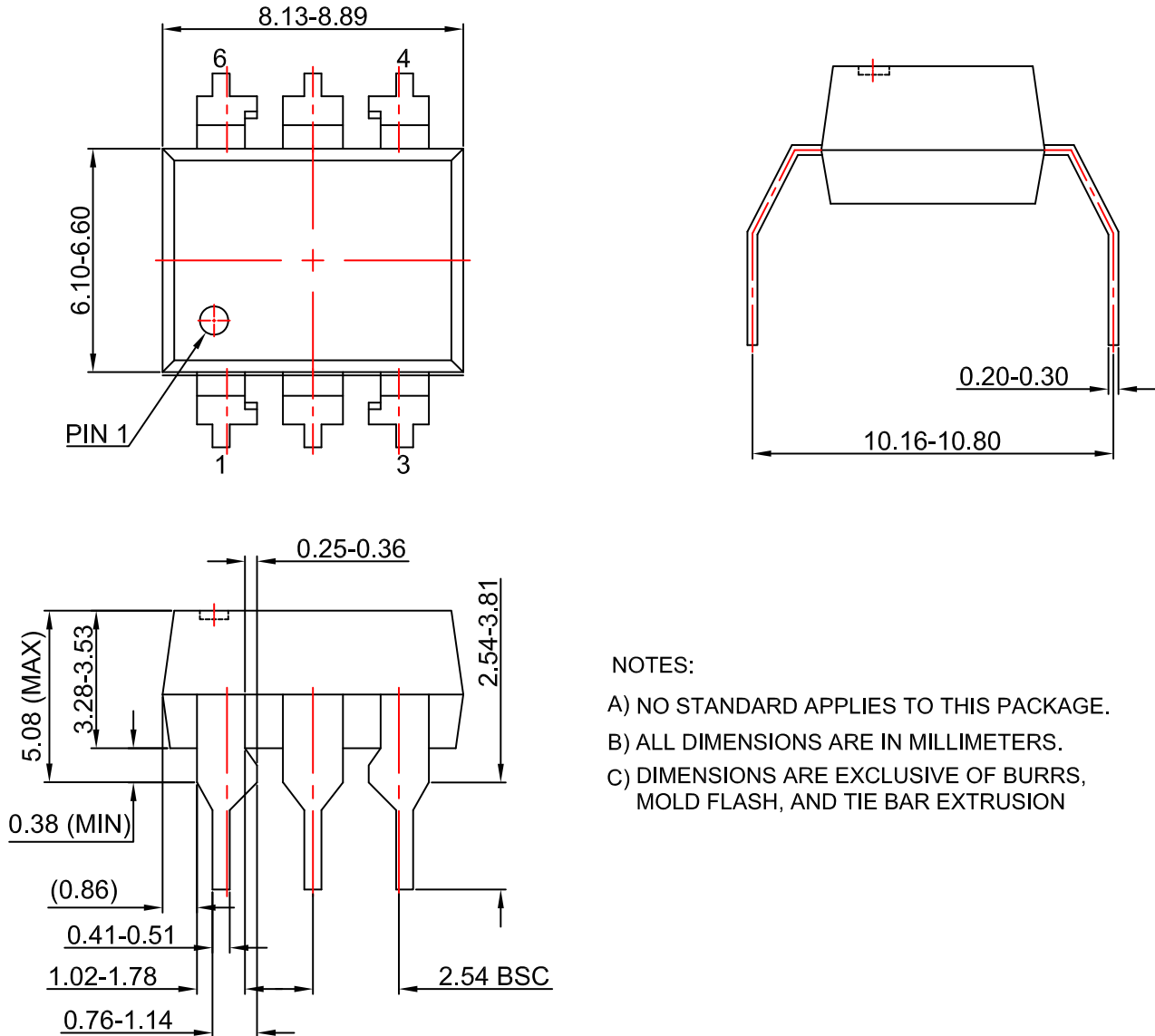

NOTES:

- A) NO STANDARD APPLIES TO THIS PACKAGE.
- B) ALL DIMENSIONS ARE IN MILLIMETERS.
- C) DIMENSIONS ARE EXCLUSIVE OF BURRS, MOLD FLASH, AND TIE BAR EXTRUSION

| | | |
|-------------------------|-------------------------------|--|
| DOCUMENT NUMBER: | 98AON13451G | Electronic versions are uncontrolled except when accessed directly from the Document Repository. Printed versions are uncontrolled except when stamped "CONTROLLED COPY" in red. |
| DESCRIPTION: | PDIP6 8.51X6.35, 2.54P | PAGE 1 OF 1 |

ON Semiconductor and  are trademarks of Semiconductor Components Industries, LLC dba ON Semiconductor or its subsidiaries in the United States and/or other countries. ON Semiconductor reserves the right to make changes without further notice to any products herein. ON Semiconductor makes no warranty, representation or guarantee regarding the suitability of its products for any particular purpose, nor does ON Semiconductor assume any liability arising out of the application or use of any product or circuit, and specifically disclaims any and all liability, including without limitation special, consequential or incidental damages. ON Semiconductor does not convey any license under its patent rights nor the rights of others.

onsemi, **Onsemi**, and other names, marks, and brands are registered and/or common law trademarks of Semiconductor Components Industries, LLC dba "**onsemi**" or its affiliates and/or subsidiaries in the United States and/or other countries. **onsemi** owns the rights to a number of patents, trademarks, copyrights, trade secrets, and other intellectual property. A listing of **onsemi**'s product/patent coverage may be accessed at www.onsemi.com/site/pdf/Patent-Marking.pdf. **onsemi** reserves the right to make changes at any time to any products or information herein, without notice. The information herein is provided "as-is" and **onsemi** makes no warranty, representation or guarantee regarding the accuracy of the information, product features, availability, functionality, or suitability of its products for any particular purpose, nor does **onsemi** assume any liability arising out of the application or use of any product or circuit, and specifically disclaims any and all liability, including without limitation special, consequential or incidental damages. Buyer is responsible for its products and applications using **onsemi** products, including compliance with all laws, regulations and safety requirements or standards, regardless of any support or applications information provided by **onsemi**. "Typical" parameters which may be provided in **onsemi** data sheets and/or specifications can and do vary in different applications and actual performance may vary over time. All operating parameters, including "Typicals" must be validated for each customer application by customer's technical experts. **onsemi** does not convey any license under any of its intellectual property rights nor the rights of others. **onsemi** products are not designed, intended, or authorized for use as a critical component in life support systems or any FDA Class 3 medical devices or medical devices with a same or similar classification in a foreign jurisdiction or any devices intended for implantation in the human body. Should Buyer purchase or use **onsemi** products for any such unintended or unauthorized application, Buyer shall indemnify and hold **onsemi** and its officers, employees, subsidiaries, affiliates, and distributors harmless against all claims, costs, damages, and expenses, and reasonable attorney fees arising out of, directly or indirectly, any claim of personal injury or death associated with such unintended or unauthorized use, even if such claim alleges that **onsemi** was negligent regarding the design or manufacture of the part. **onsemi** is an Equal Opportunity/Affirmative Action Employer. This literature is subject to all applicable copyright laws and is not for resale in any manner.

ADDITIONAL INFORMATION

TECHNICAL PUBLICATIONS:

Technical Library: www.onsemi.com/design/resources/technical-documentation
onsemi Website: www.onsemi.com

ONLINE SUPPORT: www.onsemi.com/support

For additional information, please contact your local Sales Representative at www.onsemi.com/support/sales

Looking for pricing, stock, or lifecycle information?

Click below to explore more details on WIN SOURCE:

- ⊖ [View CNY17F3TVM](#) on WIN SOURCE
- ⊖ [ON Semiconductor](#) Information

Optimize Your Supply Chain with WIN SOURCE Solutions

- ✓ Global Sourcing Solution
- ✓ Obsolete Management
- ✓ Cost Control Management
- ✓ Shortage Management
- ✓ Alternative Solution
- ✓ Excess Inventory Management