



**THE DATASHEET OF
CEP125NP-2R8MC-H**



SMD Power Inductor CEP125



Description

- Ferrite core construction.
- Magnetically shielded.
- L × W × H: 12.9 × 12.9 × 5.6 mm Max.
- Product weight: 2.7g(Ref.)
- Moisture Sensitivity Level: 1
- RoHS compliance.

Environmental Data

- Operating temperature range: -40°C ~ +125°C (including coil's self temperature rise)
- Storage temperature range: -40°C ~ +125°C
- Solder reflow temperature: 260 °C peak.

Packaging

- Carrier tape and reel packaging
- 13.0" diameter reel
- 500pcs per reel

Applications

- Ideally used in portable computer CPU and other power supply.

Dimension - [mm]

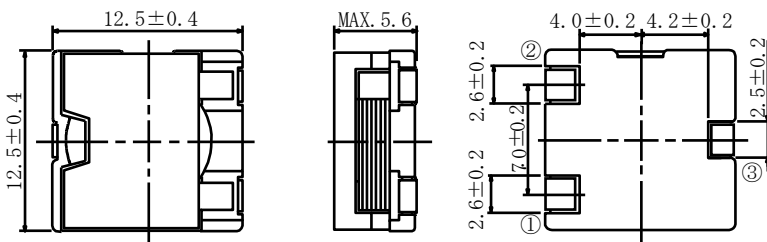

Land pattern and Schematics - [mm]

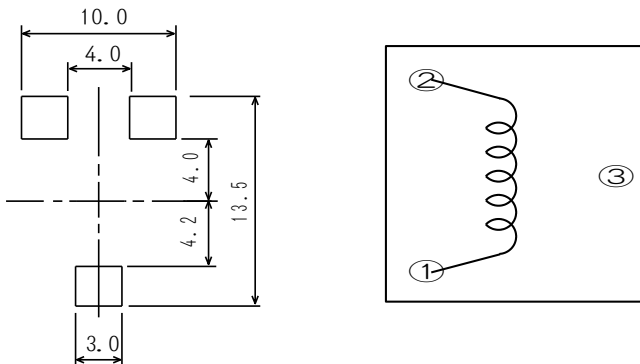



Electrical Characteristics - 1

PART NO.	STAMP	INDUCTANCE [WITHIN] ※1	D.C.R. (mΩ) [MAX.] (Typ.) (at 20°C)	SATURATION CURRENT(A) ※2		TEMPERATURE RISE CURRENT (A) ※3
				(at 20°C)	(at100°C)	
CEP125NP-1R5MC	1R5M	1.5μH±20%	2.5(2.1)	14.0	11.8	16.5
CEP125NP-2R5MC	2R5M	2.5μH±20%	3.4(2.8)	10.0	8.8	15.5
CEP125NP-4R0MC	4R0M	4.0μH±20%	5.4(4.5)	8.3	7.2	12.5
CEP125NP-6R0MC	6R0M	6.0μH±20%	8.0(6.6)	6.7	5.8	9.9
CEP125NP-8R2MC	8R2M	8.2μH±20%	11.4(9.5)	5.8	5.1	8.2
CEP125NP-100MC	100M	10.0μH±20%	13.5(11.2)	5.0	4.6	7.6

Electrical Characteristics - 2

PART NO.	STAMP	INDUCTANCE [WITHIN] ※1	D.C.R. (mΩ) [MAX.] (Typ.) (at 20°C)	SATURATION CURRENT (A) ※2		TEMPERATURE RISE CURRENT (A) ※3
				(at 20°C)	(at100°C)	
CEP125NP-1R0MC-H	1R0MH	1.0μH±20%	2.5(2.1)	20.0	17.4	16.5
CEP125NP-1R8MC-H	1R8MH	1.8μH±20%	3.4(2.8)	15.3	12.9	15.5
CEP125NP-2R8MC-H	2R8MH	2.8μH±20%	5.4(4.5)	12.3	10.2	12.5
CEP125NP-4R0MC-H	4R0MH	4.0μH±20%	8.0(6.6)	10.3	8.6	9.9
CEP125NP-5R6MC-H	5R6MH	5.6μH±20%	11.4(9.5)	8.8	7.7	8.2
CEP125NP-7R2MC-H	7R2MH	7.2μH±20%	13.5(11.2)	7.8	6.6	7.6

Electrical Characteristics - 3

PART NO.	STAMP	INDUCTANCE [WITHIN] ※1	D.C.R. (mΩ) [MAX.] (Typ.) (at 20°C)	SATURATION CURRENT (A) ※2		TEMPERATURE RISE CURRENT (A) ※3
				(at 20°C)	(at100°C)	
CEP125NP-0R3NC-U	0R3NU	0.35μH±30%	1.8(1.5)	35.0	32.0	18.5
CEP125NP-0R8NC-U	0R8NU	0.8μH±30%	2.5(2.1)	25.7	21.8	16.5
CEP125NP-1R4MC-U	1R4MU	1.4μH±20%	3.4(2.8)	19.2	16.4	15.5
CEP125NP-2R2MC-U	2R2MU	2.2μH±20%	5.4(4.5)	14.8	12.8	12.5
CEP125NP-3R2MC-U	3R2MU	3.2μH±20%	8.0(6.6)	12.8	10.9	9.9
CEP125NP-4R3MC-U	4R3MU	4.3μH±20%	11.4(9.5)	11.0	9.1	8.2
CEP125NP-5R6MC-U	5R6MU	5.6μH±20%	13.5(11.2)	9.5	7.8	7.6

※1. Measuring condition: at 100kHz.

※2. Saturation current :The value of D.C. current when the inductance decreases to 65% (while the tolerance is ±30%) or 75% (while the tolerance is ±20%) of it's nominal.

※3. Temperature rise current: The value of D.C. current when the temperature rise is Δt=40°C (Ta=20°C).

SMD Power Inductor CEP125



Saturation Current & Temperature Rise Graph

— L (20°C) — L (100°C) — ΔT

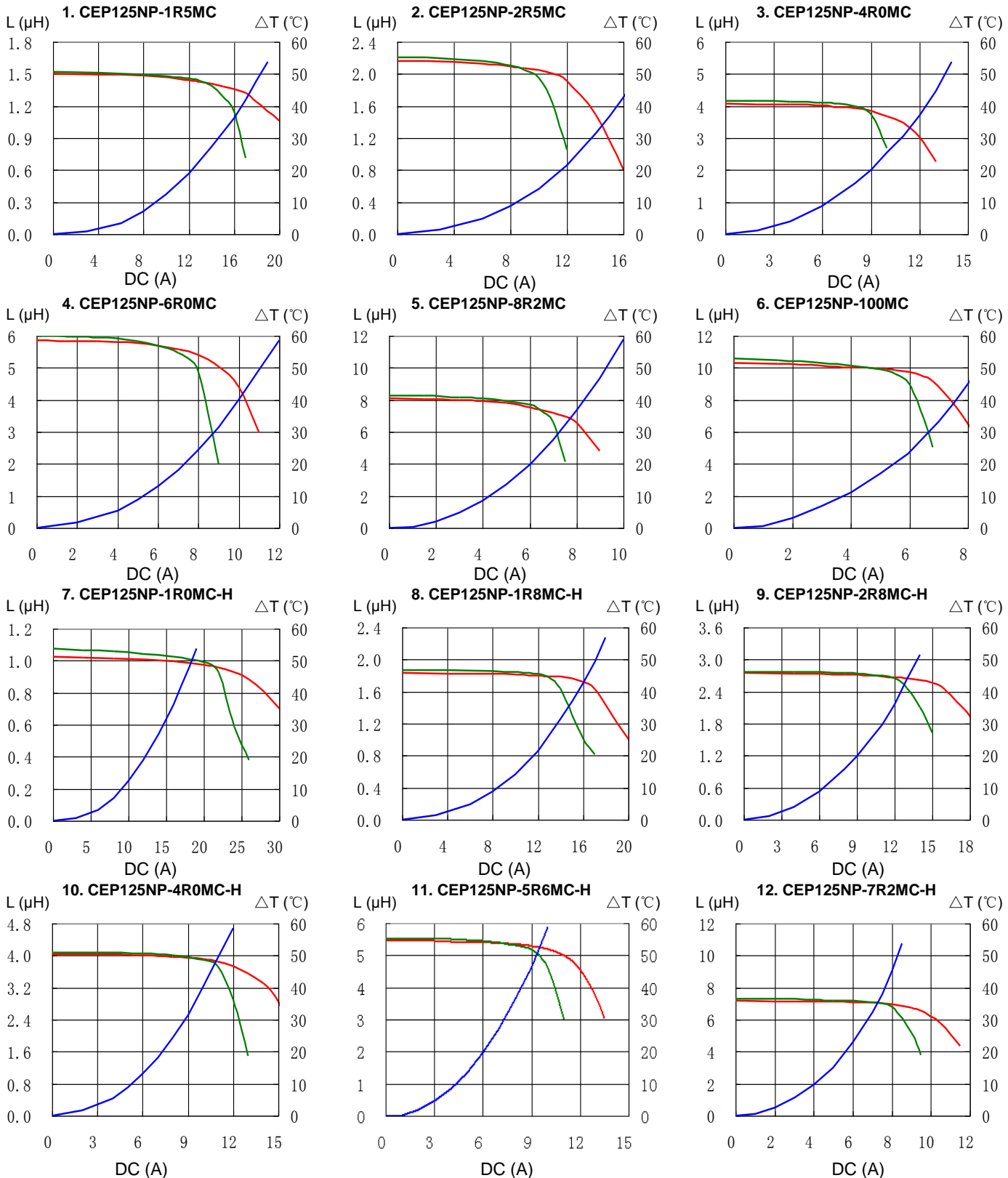

SMD Power Inductor CEP125



Saturation Current & Temperature Rise Graph

— L (20°C) — L (100°C) — ΔT

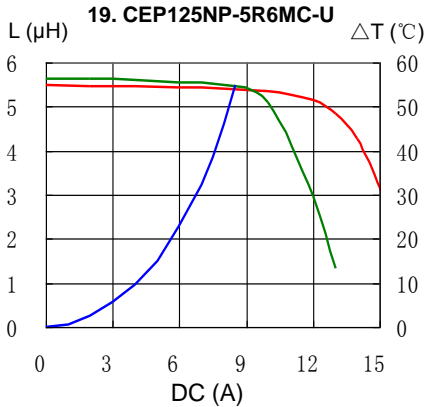
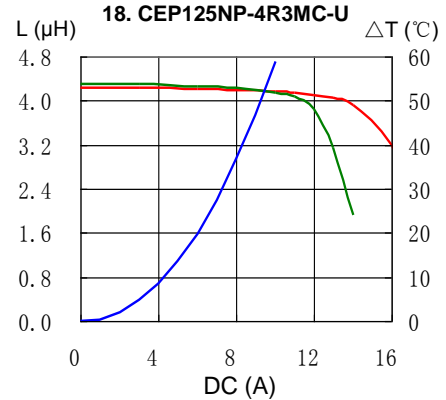
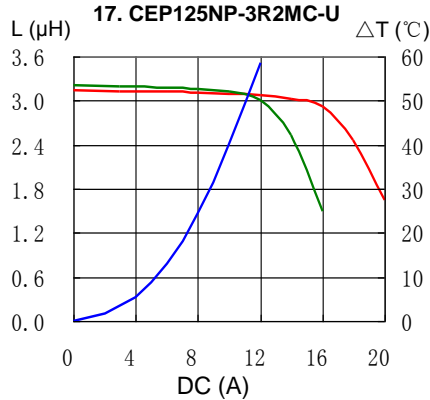
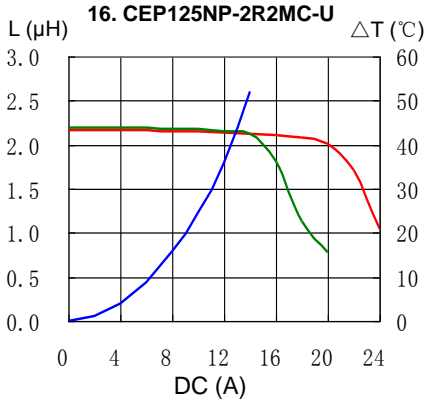
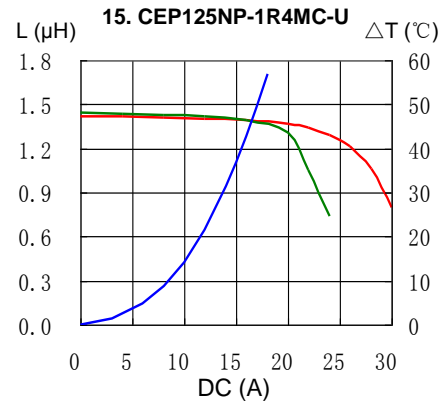
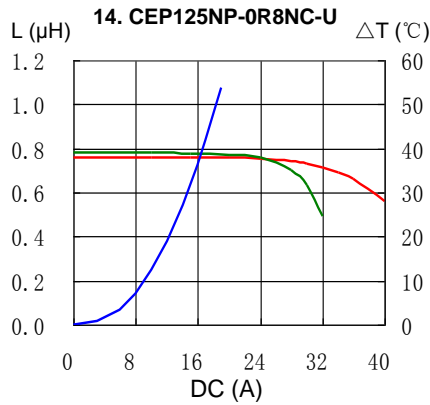
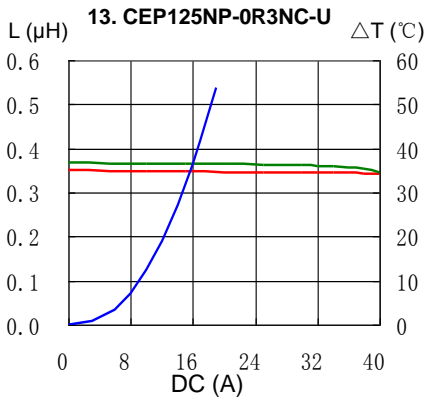

SMD Power Inductor CEP125



Solder Reflow Condition

Heat Endurance

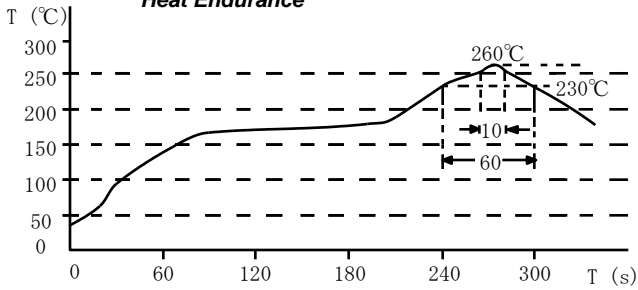

Temperature Chart

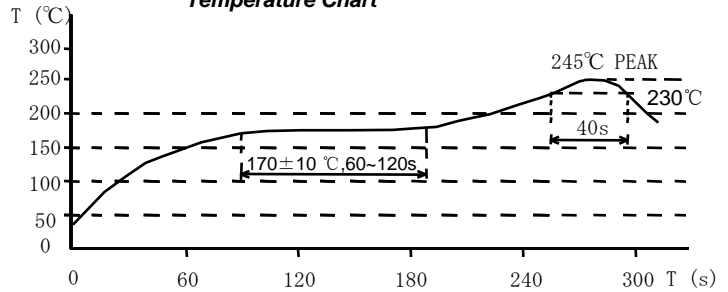

Please refer to the sales offices on our website - <http://www.sumida.com>

Hong Kong

Tel.+852-2880-6781
FAX.+852-2565-9600
sales@hk.sumida.com

Saitama(Japan)

Tel.+81-48-691-7300
FAX.+81-48-691-7340
sales@jp.sumida.com

Chicago

Tel.+1-847-545-6700
FAX. +1-847-545-6720
sales@us.sumida.com

Shanghai

Tel.+86-21-5836-3299
FAX.+86-21-5836-3266
shanghai.sales@cn.sumida.com

Seoul

Tel.+82-2-6237-0777
FAX.+82-2-6237-0778
sales@kr.sumida.com

Obernzell

Tel.+49-8591-937-0
FAX. +49-8591-937-103
contact@eu.sumida.com

Shenzhen

Tel.+86-755-8291-0228
FAX.+86-755-8291-0338
shenzhen.sales@cn.sumida.com

Singapore

Tel.+65-6296-3388
FAX.+65-6841-4426
sales@sg.sumida.com

Neumarkt

Tel.+49-9181-4509-110
FAX. +49-9181-4509-310
infocomp@eu.sumida.com

Taipei

Tel.+886-2-8751-2737
FAX.+886-2-8751-2738
sales@tw.sumida.com

San Jose

Tel.+1-408-321-9660
FAX.+1-408-321-9308
sales@us.sumida.com

Looking for pricing, stock, or lifecycle information?

Click below to explore more details on WIN SOURCE:

- ⊖ [View CEP125NP-2R8MC-H on WIN SOURCE](#)
- ⊖ [Sumida America Components Inc. Information](#)

Optimize Your Supply Chain with WIN SOURCE Solutions

- ✓ Global Sourcing Solution
- ✓ Obsolete Management
- ✓ Cost Control Management
- ✓ Shortage Management
- ✓ Alternative Solution
- ✓ Excess Inventory Management