



**THE DATASHEET OF  
CD54NP-560KC**



# SMD Power Inductor CD54



## Description

- Ferrite drum core construction.
- Magnetically unshielded.
- L × W × H: 6.1 × 5.5 × 4.85mm Max.
- Product weight 0.4g(Ref.)
- Moisture Sensitivity Level: 1
- RoHS compliance.

## Dimension - [mm]

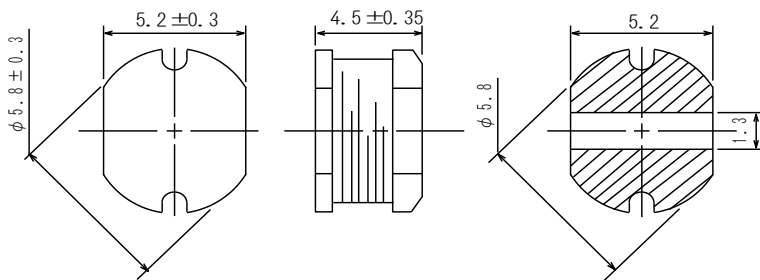

## Land pattern and Schematics - [mm]

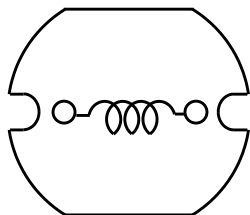
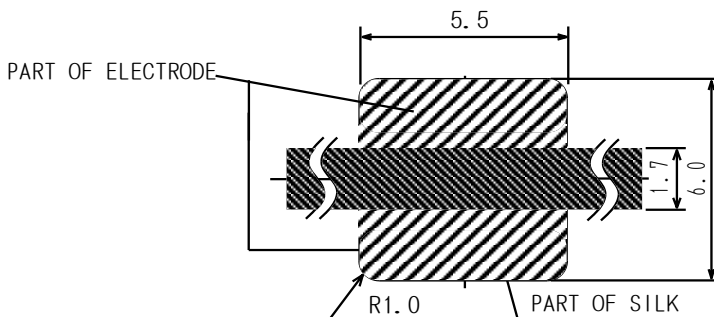

## Environmental Data

- Operating temperature range: -40°C ~ +100°C (including coil's self temperature rise)
- Storage temperature range: -40°C ~ +100°C
- Solder reflow temperature: 260 °C peak.

## Packaging

- Carrier tape and reel packaging.
- 13.0" diameter reel
- 1500pcs per reel

## Applications

- Ideally used in Mobilephone, PDA, MP3, DSC/DVC, portable DVD etc as DC-DC Converter inductors.



## Electrical Characteristics

Part Name	Stamp	Inductance ( $\mu\text{H}$ ) [within] ※1	D.C.R ( $\Omega$ ) [Max.] (at 20°C)	Rated Current (A) ※2
CD54NP-100MC	100	10 $\pm$ 20%	0.10	1.44
CD54NP-120MC	120	12 $\pm$ 20%	0.12	1.40
CD54NP-150MC	150	15 $\pm$ 20%	0.14	1.30
CD54NP-180MC	180	18 $\pm$ 20%	0.15	1.23
CD54NP-220MC	220	22 $\pm$ 20%	0.18	1.11
CD54NP-270MC	270	27 $\pm$ 20%	0.20	0.97
CD54NP-330LC	330	33 $\pm$ 15%	0.23	0.88
CD54NP-390LC	390	39 $\pm$ 15%	0.32	0.80
CD54NP-470LC	470	47 $\pm$ 15%	0.37	0.72
CD54NP-560KC	560	56 $\pm$ 10%	0.42	0.68
CD54NP-680KC	680	68 $\pm$ 10%	0.46	0.61
CD54NP-820KC	820	82 $\pm$ 10%	0.60	0.58
CD54NP-101KC	101	100 $\pm$ 10%	0.70	0.52
CD54NP-121KC	121	120 $\pm$ 10%	0.93	0.48
CD54NP-151KC	151	150 $\pm$ 10%	1.10	0.40
CD54NP-181KC	181	180 $\pm$ 10%	1.38	0.38
CD54NP-221KC	221	220 $\pm$ 10%	1.57	0.35

※1: Inductance measuring frequency: 10 $\mu\text{H}$  ~ 82 $\mu\text{H}$  , at 2.52MHz.  
100 $\mu\text{H}$  ~ 220 $\mu\text{H}$  , at 1 kHz.

※2: Rated current: The DC current at which the inductance decreases to 90 % of it's initial value or when  $\Delta t=40^\circ\text{C}$ , whichever is lower ( $T_a=20^\circ\text{C}$ ).

# SMD Power Inductor CD54



## Saturation Current & Temperature Rise Graph

— L (20°C) — L (105°C) —  $\Delta T$

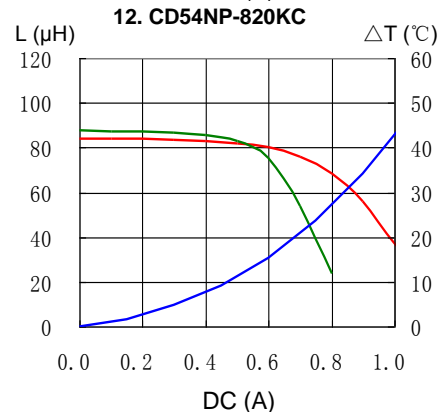
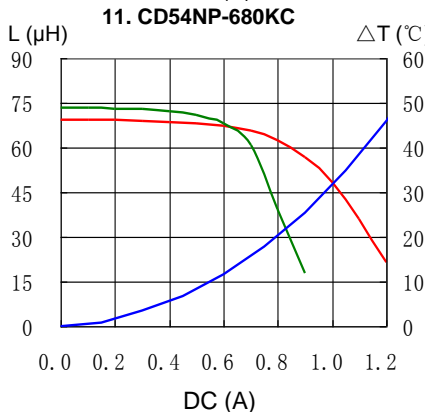
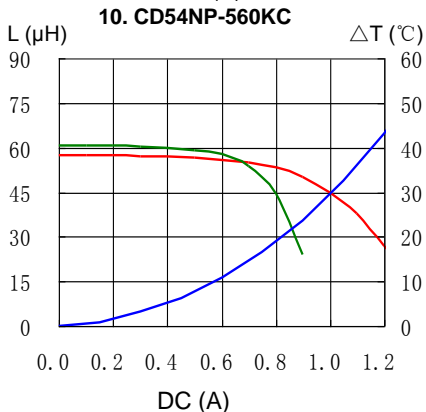
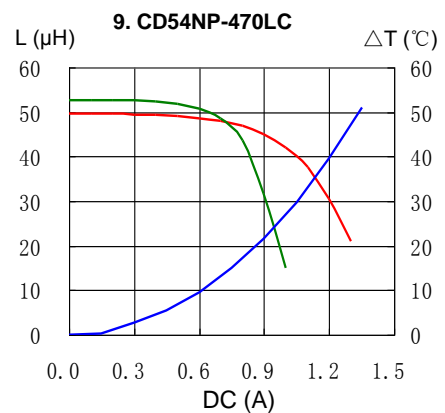
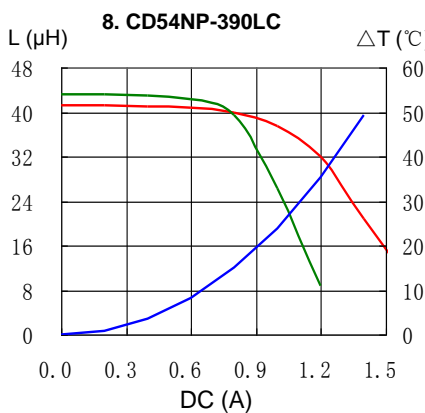
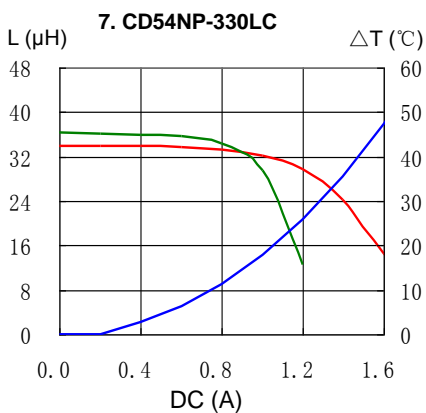
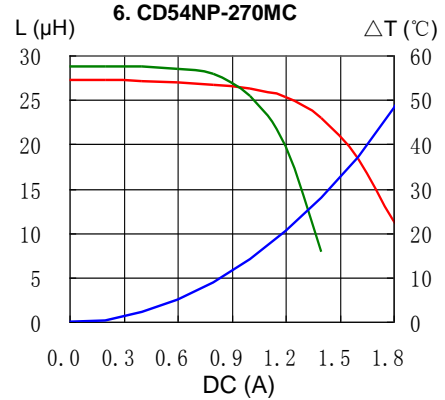
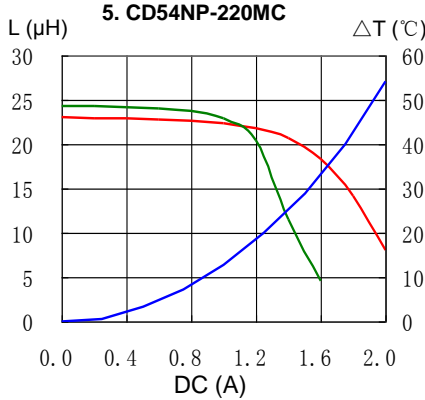
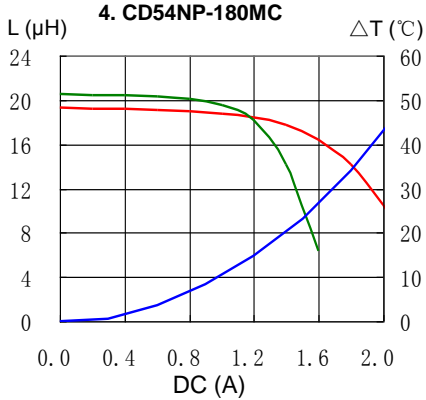
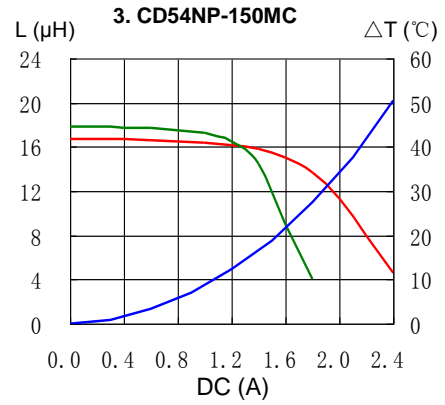
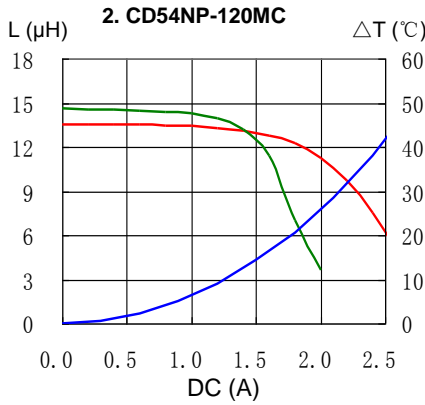
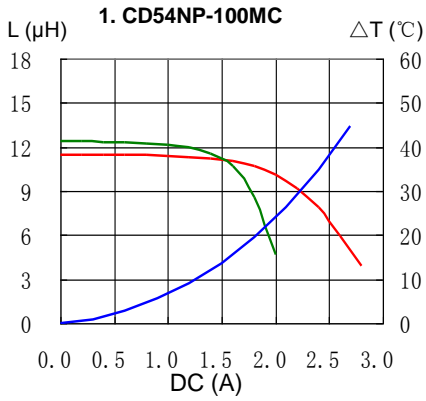

# SMD Power Inductor CD54



## Saturation Current & Temperature Rise Graph

— L (20°C) — L (105°C) —  $\Delta T$

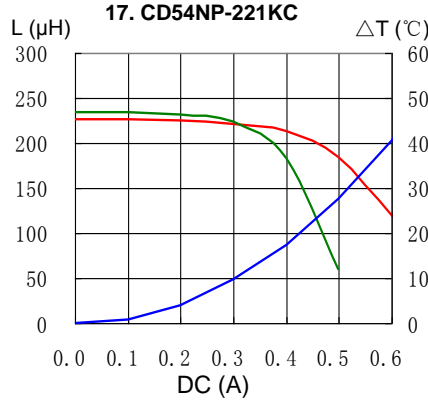
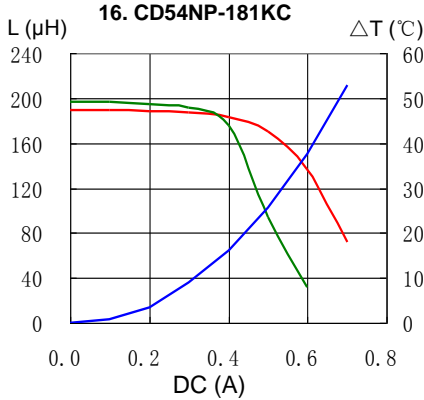
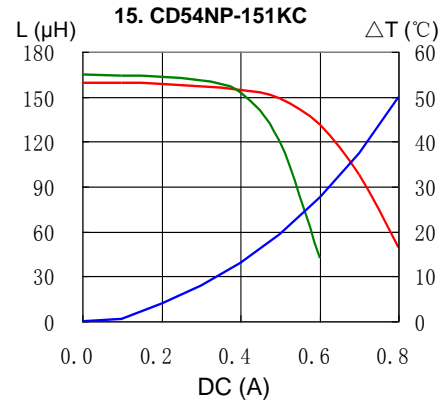
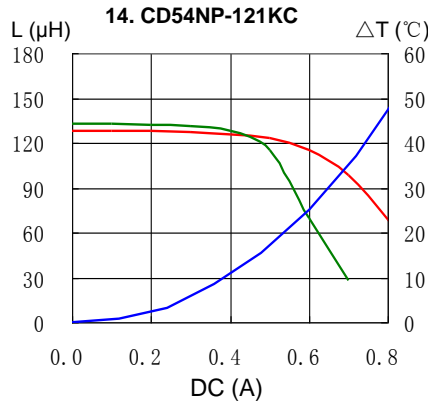
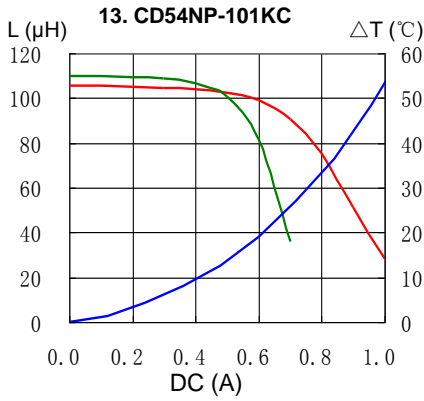

## Solder Reflow Condition

Heat Endurance

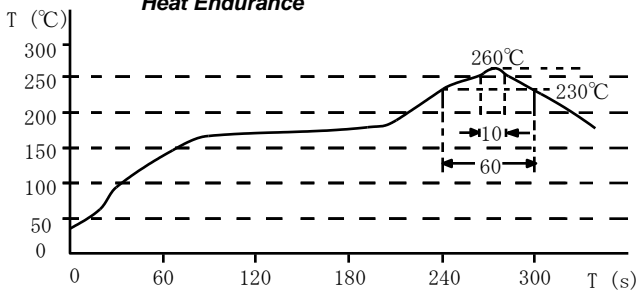

Temperature Chart

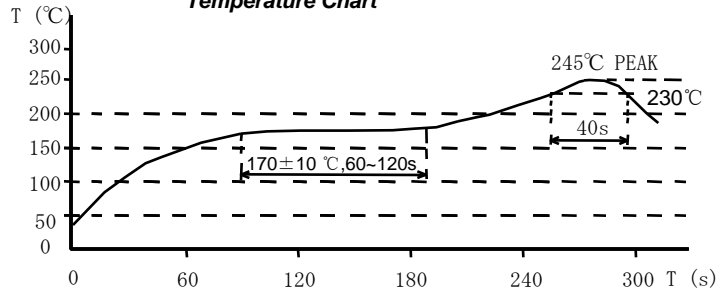

Please refer to the sales offices on our website - <http://www.sumida.com>

### Hong Kong

Tel.+852-2880-6781  
FAX.+852-2565-9600  
[sales@hk.sumida.com](mailto:sales@hk.sumida.com)

### Saitama(Japan)

Tel.+81-48-691-7300  
FAX.+81-48-691-7340  
[sales@jp.sumida.com](mailto:sales@jp.sumida.com)

### Chicago

Tel.+1-847-545-6700  
FAX. +1-847-545-6720  
[sales@us.sumida.com](mailto:sales@us.sumida.com)

### Shanghai

Tel.+86-21-5836-3299  
FAX.+86-21-5836-3266  
[shanghai.sales@cn.sumida.com](mailto:shanghai.sales@cn.sumida.com)

### Seoul

Tel.+82-2-6237-0777  
FAX.+82-2-6237-0778  
[sales@kr.sumida.com](mailto:sales@kr.sumida.com)

### Obernzell

Tel.+49-8591-937-0  
FAX. +49-8591-937-103  
[contact@eu.sumida.com](mailto:contact@eu.sumida.com)

### Shenzhen

Tel.+86-755-8291-0228  
FAX.+86-755-8291-0338  
[shenzhen.sales@cn.sumida.com](mailto:shenzhen.sales@cn.sumida.com)

### Singapore

Tel.+65-6296-3388  
FAX.+65-6841-4426  
[sales@sg.sumida.com](mailto:sales@sg.sumida.com)

### Neumarkt

Tel.+49-9181-4509-110  
FAX. +49-9181-4509-310  
[infocomp@eu.sumida.com](mailto:infocomp@eu.sumida.com)

### Taipei



Tel.+886-2-8751-2737  
FAX.+886-2-8751-2738  
[sales@tw.sumida.com](mailto:sales@tw.sumida.com)

### San Jose

Tel.+1-408-321-9660  
FAX.+1-408-321-9308  
[sales@us.sumida.com](mailto:sales@us.sumida.com)

## Looking for pricing, stock, or lifecycle information?

Click below to explore more details on WIN SOURCE:

-  [View CD54NP-560KC on WIN SOURCE](#)
-  [Sumida America Components Inc. Information](#)

## Optimize Your Supply Chain with WIN SOURCE Solutions

-  Global Sourcing Solution
-  Obsolete Management
-  Cost Control Management
-  Shortage Management
-  Alternative Solution
-  Excess Inventory Management