



**THE DATASHEET OF
BZT52C2V0TQ-7-F**



Features

- Small, Low Profile Surface Mount Package
- Flat Lead Package Design for Low Profile and High Power Dissipation
- **Totally Lead-Free & Fully RoHS Compliant (Notes 1 & 2)**
- **Halogen and Antimony Free. "Green" Device (Note 3)**
- **Qualified to AEC-Q101 Standards for High Reliability**
- **PPAP Capable (Note 4)**

Mechanical Data

- Case: SOD523
- Case Material: Molded Plastic, "Green" Molding Compound. UL Flammability Classification Rating 94V-0
- Moisture Sensitivity: Level 1 per J-STD-020
- Terminal Connections: Cathode Band
- Terminals: Finish - Matte Tin Annealed over Alloy 42 Leadframe. Solderable per MIL-STD-202, Method 208 (e3)
- Weight: 0.001 grams (Approximate)

SOD523



Top View

Ordering Information (Note 5)

| Part Number (Note 6) | Compliance | Case | Packaging |
|----------------------|------------|--------|--------------------|
| (Type Number)-7* | Standard | SOD523 | 3,000/Tape & Reel |
| (Type Number)Q-7-F* | Automotive | SOD523 | 3,000/Tape & Reel |
| (Type Number)-13* | Standard | SOD523 | 10,000/Tape & Reel |
| (Type Number)Q-13-F* | Automotive | SOD523 | 10,000/Tape & Reel |

*For (Type Number), please see the Electrical Characteristics Table. Example: 6.2V Zener = BZT52C6V2T-7.

- Notes:
1. No purposely added lead. Fully EU Directive 2002/95/EC (RoHS) & 2011/65/EU (RoHS 2) compliant.
 2. See http://www.diodes.com/quality/lead_free.html for more information about Diodes Incorporated's definitions of Halogen- and Antimony-free, "Green" and Lead-free.
 3. Halogen- and Antimony-free "Green" products are defined as those which contain <900ppm bromine, <900ppm chlorine (<1500ppm total Br + Cl) and <1000ppm antimony compounds.
 4. Automotive products are AEC-Q101 qualified and are PPAP capable. Automotive, AEC-Q101 and standard products are electrically and thermally the same, except where specified. For more information, please refer to <https://www.diodes.com/quality/product-compliance-definitions/>.
 5. For packaging details, go to our website at <https://www.diodes.com/design/support/packaging/diodes-packaging/>.
 6. Dispensed in every other cavity of the tape.

Marking Information

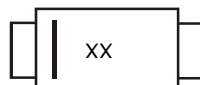

XX = Product Type Marking Code
(See Electrical Characteristics Table)

Maximum Ratings (@T_A = +25°C, unless otherwise specified.)

Single phase, half wave, 60Hz, resistive or inductive load.
For capacitive load, derate current by 20%.

| Characteristic | Symbol | Value | Unit |
|---|----------------|-------|------|
| Forward Voltage @ I _F = 10mA | V _F | 0.9 | V |

Thermal Characteristics

| Characteristic | Symbol | Value | Unit |
|--|-----------------------------------|-------------|------|
| Power Dissipation (Note 7) | P _D | 300 | mW |
| Thermal Resistance, Junction to Ambient Air (Note 7) | R _{θJA} | 417 | °C/W |
| Thermal Resistance, Junction to Case (Note 7) | R _{θJC} | 160 | °C/W |
| Operating and Storage Temperature Range | T _J , T _{STG} | -65 to +150 | °C |

Electrical Characteristics (@T_A = +25°C, unless otherwise specified.)

| Type Number | Marking Codes | Zener Voltage Range (Note 8) | | | | Maximum Zener Impedance f = 1kHz | | | Maximum Reverse Current (Note 8) | | Temperature Coefficient @ I _{ZT} mV/°C | |
|-------------|---------------|----------------------------------|---------|---------|-----------------|-----------------------------------|-----------------------------------|-----------------|----------------------------------|------------------|---|------|
| | | V _Z @ I _{ZT} | | | I _{ZT} | Z _{ZT} @ I _{ZT} | Z _{ZK} @ I _{ZK} | I _{ZK} | I _R | @ V _R | Min | Max |
| | | Nom (V) | Min (V) | Max (V) | mA | Ω | mA | μA | V | | | |
| BZT52C2V0T | WY | 2.0 | 1.91 | 2.09 | 5 | 100 | 600 | 1.0 | 150 | 1.0 | -3.5 | 0 |
| BZT52C2V4T | WX | 2.4 | 2.2 | 2.6 | 5 | 100 | 600 | 1.0 | 50 | 1.0 | -3.5 | 0 |
| BZT52C2V7T | W1 | 2.7 | 2.5 | 2.9 | 5 | 100 | 600 | 1.0 | 20 | 1.0 | -3.5 | 0 |
| BZT52C3V0T | W2 | 3.0 | 2.8 | 3.2 | 5 | 95 | 600 | 1.0 | 10 | 1.0 | -3.5 | 0 |
| BZT52C3V3T | W3 | 3.3 | 3.1 | 3.5 | 5 | 95 | 600 | 1.0 | 5.0 | 1.0 | -3.5 | 0 |
| BZT52C3V6T | W4 | 3.6 | 3.4 | 3.8 | 5 | 90 | 600 | 1.0 | 5.0 | 1.0 | -3.5 | 0 |
| BZT52C3V9T | W5 | 3.9 | 3.7 | 4.1 | 5 | 90 | 600 | 1.0 | 3.0 | 1.0 | -3.5 | 0 |
| BZT52C4V3T | W6 | 4.3 | 4.0 | 4.6 | 5 | 90 | 600 | 1.0 | 3.0 | 1.0 | -3.5 | 0 |
| BZT52C4V7T | W7 | 4.7 | 4.4 | 5.0 | 5 | 80 | 500 | 1.0 | 3.0 | 2.0 | -3.5 | 0.2 |
| BZT52C5V1T | W8 | 5.1 | 4.8 | 5.4 | 5 | 60 | 480 | 1.0 | 2.0 | 2.0 | -2.7 | 1.2 |
| BZT52C5V6T | W9 | 5.6 | 5.2 | 6.0 | 5 | 40 | 400 | 1.0 | 1.0 | 2.0 | -2 | 2.5 |
| BZT52C6V2T | WA | 6.2 | 5.8 | 6.6 | 5 | 10 | 150 | 1.0 | 3.0 | 4.0 | 0.4 | 3.7 |
| BZT52C6V8T | WB | 6.8 | 6.4 | 7.2 | 5 | 15 | 80 | 1.0 | 2.0 | 4.0 | 1.2 | 4.5 |
| BZT52C7V5T | WC | 7.5 | 7.0 | 7.9 | 5 | 15 | 80 | 1.0 | 1.0 | 5.0 | 2.5 | 5.3 |
| BZT52C8V2T | WD | 8.2 | 7.7 | 8.7 | 5 | 15 | 80 | 1.0 | 0.7 | 5.0 | 3.2 | 6.2 |
| BZT52C9V1T | WE | 9.1 | 8.5 | 9.6 | 5 | 15 | 100 | 1.0 | 0.5 | 6.0 | 3.8 | 7.0 |
| BZT52C10T | WF | 10 | 9.4 | 10.6 | 5 | 20 | 150 | 1.0 | 0.2 | 7.0 | 4.5 | 8.0 |
| BZT52C11T | WG | 11 | 10.4 | 11.6 | 5 | 20 | 150 | 1.0 | 0.1 | 8.0 | 5.4 | 9.0 |
| BZT52C12T | WH | 12 | 11.4 | 12.7 | 5 | 25 | 150 | 1.0 | 0.1 | 8.0 | 6.0 | 10.0 |
| BZT52C13T | WI | 13 | 12.4 | 14.1 | 5 | 30 | 170 | 1.0 | 0.1 | 8.0 | 7.0 | 11.0 |
| BZT52C15T | WJ | 15 | 13.8 | 15.6 | 5 | 30 | 200 | 1.0 | 0.1 | 10.5 | 9.2 | 13.0 |
| BZT52C16T | WK | 16 | 15.3 | 17.1 | 5 | 40 | 200 | 1.0 | 0.1 | 11.2 | 10.4 | 14.0 |
| BZT52C18T | WL | 18 | 16.8 | 19.1 | 5 | 45 | 225 | 1.0 | 0.1 | 12.6 | 12.4 | 16.0 |
| BZT52C20T | WM | 20 | 18.8 | 21.2 | 5 | 55 | 225 | 1.0 | 0.1 | 14.0 | 14.4 | 18.0 |
| BZT52C22T | WN | 22 | 20.8 | 23.3 | 5 | 55 | 250 | 1.0 | 0.1 | 15.4 | 16.4 | 20.0 |
| BZT52C24T | WO | 24 | 22.8 | 25.6 | 5 | 70 | 250 | 1.0 | 0.1 | 16.8 | 18.4 | 22.0 |
| BZT52C36T | WS | 36 | 34.0 | 38.0 | 2 | 90 | 350 | 0.5 | 0.1 | 25.2 | 30.4 | - |

Notes: 7. Part mounted on FR-4 PC board, single-sided, 2oz. copper with pad area 1.92mm².
8. Short duration pulse test used to minimize self-heating effect.

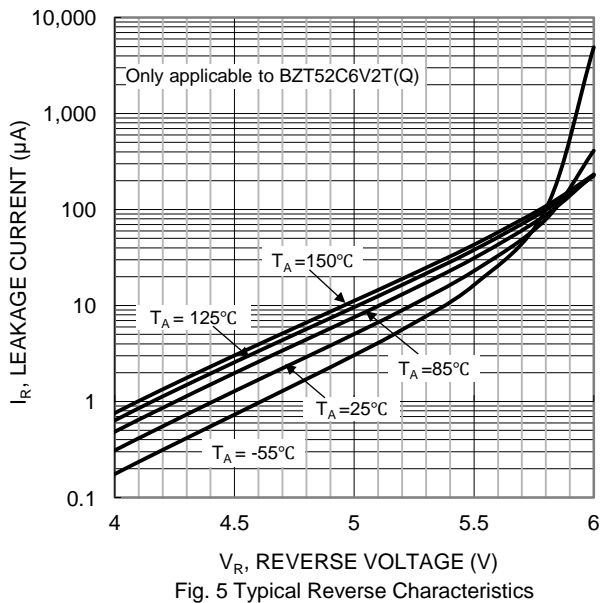
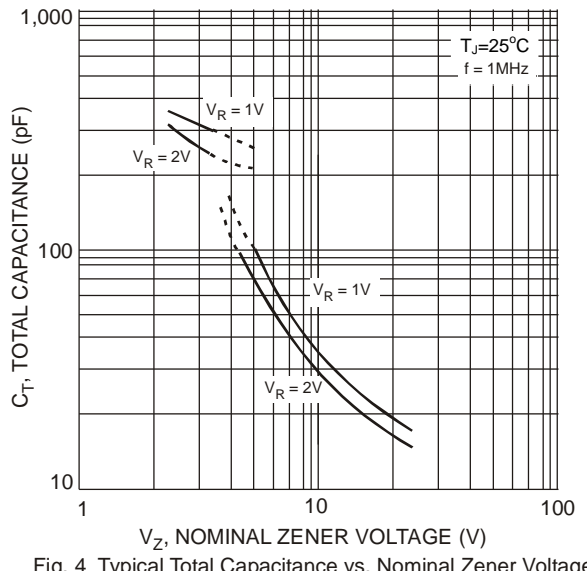
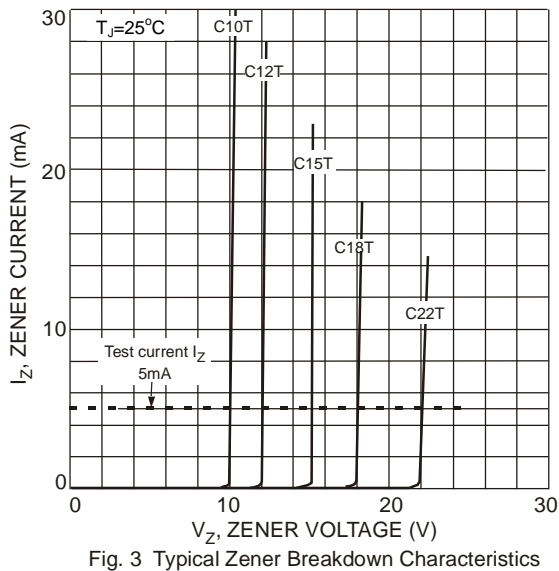
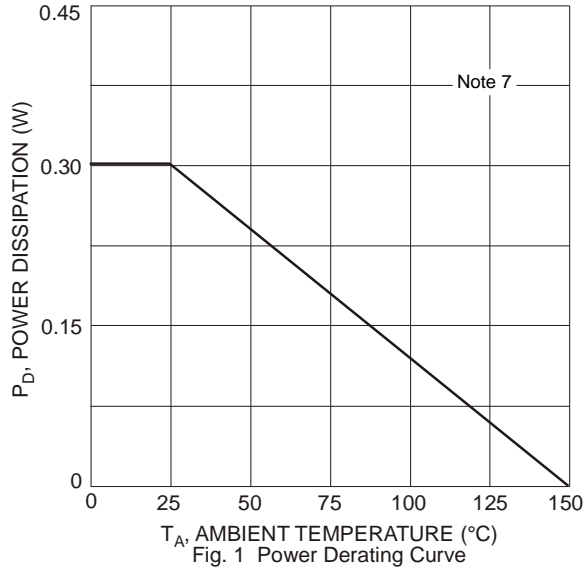

Package Outline Dimensions

Please see <http://www.diodes.com/package-outlines.html> for the latest version.

SOD523

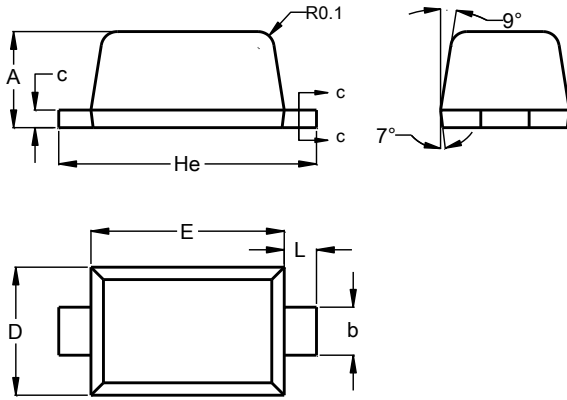

| SOD523 | | |
|----------------------|------|------|
| Dim | Min | Max |
| A | 0.55 | 0.65 |
| b | 0.26 | 0.34 |
| c | 0.11 | 0.17 |
| D | 0.75 | 0.85 |
| E | 1.15 | 1.25 |
| He | 1.55 | 1.65 |
| L | 0.10 | 0.30 |
| All Dimensions in mm | | |

Suggested Pad Layout

Please see <http://www.diodes.com/package-outlines.html> for the latest version.

SOD523



| Dimensions | Value (in mm) |
|------------|---------------|
| G | 0.80 |
| X | 0.60 |
| X1 | 2.00 |
| Y | 0.70 |

IMPORTANT NOTICE

DIODES INCORPORATED MAKES NO WARRANTY OF ANY KIND, EXPRESS OR IMPLIED, WITH REGARDS TO THIS DOCUMENT, INCLUDING, BUT NOT LIMITED TO, THE IMPLIED WARRANTIES OF MERCHANTABILITY AND FITNESS FOR A PARTICULAR PURPOSE (AND THEIR EQUIVALENTS UNDER THE LAWS OF ANY JURISDICTION).

Diodes Incorporated and its subsidiaries reserve the right to make modifications, enhancements, improvements, corrections or other changes without further notice to this document and any product described herein. Diodes Incorporated does not assume any liability arising out of the application or use of this document or any product described herein; neither does Diodes Incorporated convey any license under its patent or trademark rights, nor the rights of others. Any Customer or user of this document or products described herein in such applications shall assume all risks of such use and will agree to hold Diodes Incorporated and all the companies whose products are represented on Diodes Incorporated website, harmless against all damages.

Diodes Incorporated does not warrant or accept any liability whatsoever in respect of any products purchased through unauthorized sales channel. Should Customers purchase or use Diodes Incorporated products for any unintended or unauthorized application, Customers shall indemnify and hold Diodes Incorporated and its representatives harmless against all claims, damages, expenses, and attorney fees arising out of, directly or indirectly, any claim of personal injury or death associated with such unintended or unauthorized application.

Products described herein may be covered by one or more United States, international or foreign patents pending. Product names and markings noted herein may also be covered by one or more United States, international or foreign trademarks.

This document is written in English but may be translated into multiple languages for reference. Only the English version of this document is the final and determinative format released by Diodes Incorporated.

LIFE SUPPORT

Diodes Incorporated products are specifically not authorized for use as critical components in life support devices or systems without the express written approval of the Chief Executive Officer of Diodes Incorporated. As used herein:

A. Life support devices or systems are devices or systems which:

1. are intended to implant into the body, or
2. support or sustain life and whose failure to perform when properly used in accordance with instructions for use provided in the labeling can be reasonably expected to result in significant injury to the user.

B. A critical component is any component in a life support device or system whose failure to perform can be reasonably expected to cause the failure of the life support device or to affect its safety or effectiveness.



Customers represent that they have all necessary expertise in the safety and regulatory ramifications of their life support devices or systems, and acknowledge and agree that they are solely responsible for all legal, regulatory and safety-related requirements concerning their products and any use of Diodes Incorporated products in such safety-critical, life support devices or systems, notwithstanding any devices- or systems-related information or support that may be provided by Diodes Incorporated. Further, Customers must fully indemnify Diodes Incorporated and its representatives against any damages arising out of the use of Diodes Incorporated products in such safety-critical, life support devices or systems.

Copyright © 2017, Diodes Incorporated

www.diodes.com

Looking for pricing, stock, or lifecycle information?

Click below to explore more details on WIN SOURCE:

-  [View BZT52C2V0TQ-7-F on WIN SOURCE](#)
-  [Diodes Incorporated Information](#)

Optimize Your Supply Chain with WIN SOURCE Solutions

-  Global Sourcing Solution
-  Obsolete Management
-  Cost Control Management
-  Shortage Management
-  Alternative Solution
-  Excess Inventory Management