



**THE DATASHEET OF  
BZD27C4V3P**



**SILICON PLANAR ZENER DIODE**

**FEATURES**

- \* Silicon planar zener diodes.
- \* Low profile surface-mount package.
- \* Zener and surge current specification
- \* Low leakage current
- \* Excellent stability
- \* High temperature soldering guaranteed: 265°C /10 seconds, at terminals
- \* Halogen-free

**MECHANICAL DATA**

- \* Case: JEDEC SOD-123F(L)-1 molded plastic
- \* Polarity: Color band denotes positive end ( cathode ) except for bidirectional
- \* Weight: 0.006 ounces, 0.02 grams
- \* Mounting position: Any

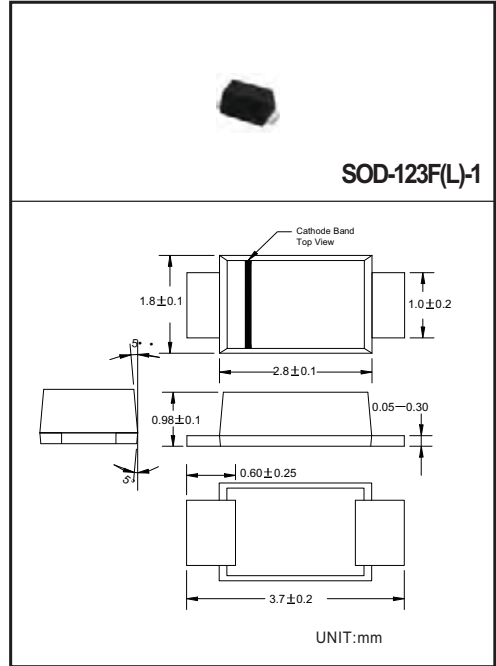

**ABSOLUTE MAXIMUM RATINGS AND CHARACTERISTICS** Ratings at 25 °C ambient temperature unless otherwise specified

RATINGS	SYMBOL	VALUE	UNITS
Non-repetitive peak pulse power dissipation with a 10/1000µs waveform (NOTE 1)	$P_{PPM}$	150	Watts
Power dissipation at $T_A=25^{\circ}C$ (NOTE 2)	$P_{tot}$	0.8	Watts
Reverse current at stand-off voltage @ $V_{WM}$	$I_R$	SEE TABLE 1	µ A
Maximum instantaneous forward voltage at 0.2A	$V_F$	1.2	Volts
Thermal resistance junction to ambient	$R_{\theta JA}$	180	K/W
Operating temperature junction range	$T_J$	- 55 to +175	°C
Storage temperature range	$T_{STG}$	- 55 to +175	°C

NOTES:(1) $T_J=25^{\circ}C$  prior to surge.

(2)Mounted on epoxy-glass PCB with 3×3 mm Cu pads( $\geq 40\mu m$  thick)

(3)Non-repetitive peak reverse current in accordance with "IEC 60-1,Section 8" (10/1000µs pulse)

2020-11/08  
REV:F

# RATING AND CHARACTERISTICS CURVES ( BZD27CxxP)

Figure 1. Forward Current vs. Forward Voltage

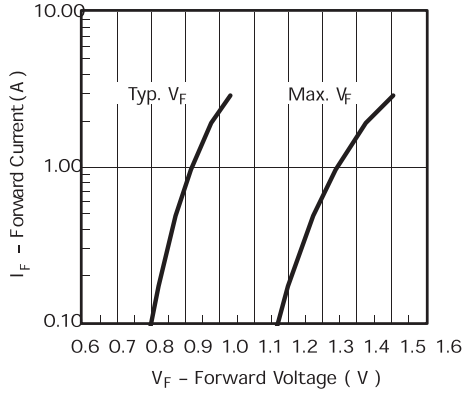

Figure 2. Maximum Pulse Power Dissipation vs. Zener Voltage

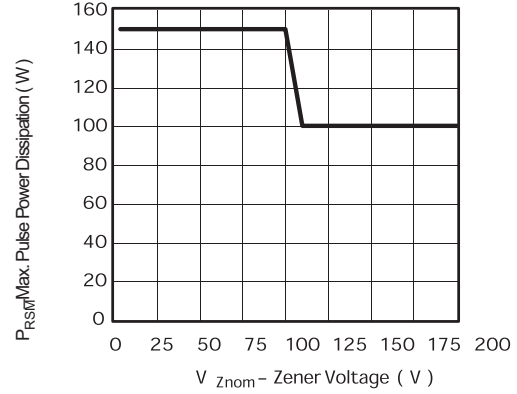

Figure 3. Typ. Diode Capacitance vs. Reverse Voltage

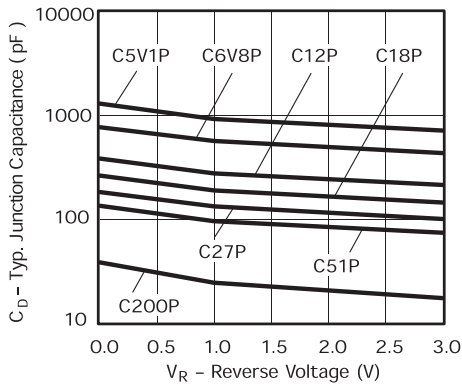

Figure 4. Non-Repetitive Peak Reverse Current Pulse Definition

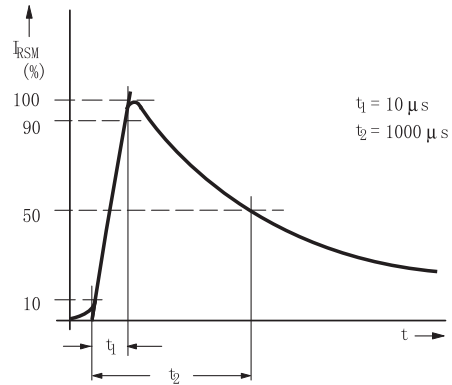
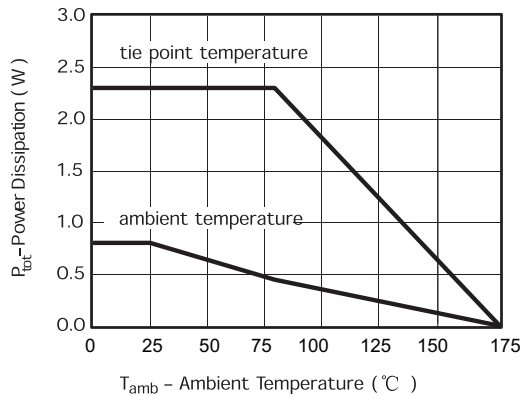

Figure 5. Power Dissipation vs. Ambient Temperature



ELECTRICAL CHARACTERISTICS (at TA=25°C unless otherwise noted)

When used as voltage regulator diodes

Partnumber	Marking code	Working voltage (NOTE 1)		Differential resistance		Temperature coefficient		Test current	Reverse current at reverse voltage	
		$V_z@I_{zT}$		$r_{dif}@I_z$		$\alpha_z@I_z$			$I_{zT}$	$I_R$
		V		$\Omega$		%/°C		m A	$\mu$ A	V
		min	max	typ	max	min	max		max	
BZD27C3V6P	D0	3.4	3.8	4	8	-0.14	-0.04	100	100	1
BZD27C3V9P	D1	3.7	4.1	4	8	-0.14	-0.04	100	50	1
BZD27C4V3P	D2	4	4.6	4	7	-0.12	-0.02	100	25	1
BZD27C4V7P	D3	4.4	5	3	7	-0.1	0	100	10	1
BZD27C5V1P	D4	4.8	5.4	3	6	-0.08	0.02	100	5	1
BZD27C5V6P	D5	5.2	6	2	4	-0.04	0.04	100	10	2
BZD27C6V2P	D6	5.8	6.6	2	3	-0.01	0.06	100	5	2
BZD27C6V8P	D7	6.4	7.2	1	3	0	0.07	100	10	3
BZD27C7V5P	D8	7	7.9	1	2	0	0.07	100	50	3
BZD27C8V2P	D9	7.7	8.7	1	2	0.03	0.08	100	10	3
BZD27C9V1P	E0	8.5	9.6	2	4	0.03	0.08	50	10	5
BZD27C10P	E1	9.4	10.6	2	4	0.05	0.09	50	7	7.5
BZD27C11P	E2	10.4	11.6	4	7	0.05	0.1	50	4.0	8.2
BZD27C12P	E3	11.4	12.7	4	7	0.05	0.1	50	3.0	9.1
BZD27C13P	E4	12.4	14.1	5	10	0.05	0.1	50	2	10
BZD27C15P	E5	13.8	15.6	5	10	0.05	0.1	50	1	11
BZD27C16P	E6	15.3	17.1	6	15	0.06	0.11	25	1	12
BZD27C18P	E7	16.8	19.1	6	15	0.06	0.11	25	1	13
BZD27C20P	E8	18.8	21.2	6	15	0.06	0.11	25	1	15
BZD27C22P	E9	20.8	23.3	6	15	0.06	0.11	25	1	16
BZD27C24P	F0	22.8	25.6	7	15	0.06	0.11	25	1	18
BZD27C27P	F1	25.1	28.9	7	15	0.06	0.11	25	1	20
BZD27C30P	F2	28	32	8	15	0.06	0.11	25	1	22
BZD27C33P	F3	31	35	8	15	0.06	0.11	25	1	24
BZD27C36P	F4	34	38	21	40	0.06	0.11	10	1	27
BZD27C39P	F5	37	41	21	40	0.06	0.11	10	1	30
BZD27C43P	F6	40	46	24	45	0.07	0.12	10	1	33
BZD27C47P	F7	44	50	24	45	0.07	0.12	10	1	36
BZD27C51P	F8	48	54	25	60	0.07	0.12	10	1	39
BZD27C56P	F9	52	60	25	60	0.07	0.12	10	1	43
BZD27C62P	G0	58	66	25	80	0.08	0.13	10	1	47
BZD27C68P	G1	64	72	25	80	0.08	0.13	10	1	51
BZD27C75P	G2	70	79	30	100	0.08	0.13	10	1	56
BZD27C82P	G3	77	87	30	100	0.08	0.13	10	1	62
BZD27C91P	G4	85	96	60	200	0.08	0.13	5	1	68
BZD27C100P	G5	94	106	60	200	0.09	0.13	5	1	75
BZD27C110P	G6	104	116	80	250	0.09	0.13	5	1	82
BZD27C120P	G7	114	127	80	250	0.09	0.13	5	1	91
BZD27C130P	G8	124	141	110	300	0.09	0.13	5	1	100
BZD27C150P	G9	138	156	130	300	0.09	0.13	5	1	110
BZD27C160P	H0	153	171	150	350	0.09	0.13	5	1	120
BZD27C180P	H1	168	191	180	400	0.09	0.13	5	1	130
BZD27C200P	H2	188	212	200	500	0.09	0.13	5	1	150
BZD27C220P	H3	208	233	430	900	0.09	0.13	5	1	160

Note: 1. Pulse test:  $t_p \leq 5ms$ .

## PACKAGING OF DIODE AND BRIDGE RECTIFIERS

### REEL PACK

PACKAGE	PACKING CODE	EA PER REEL	EA PER INNER BOX	COMPONENT SPACE (mm)	TAPE SPACE (mm)	REEL DIA (mm)	CARTON SIZE (mm)	EA PER CARTON	GROSS WEIGHT(Kg)
SOD-123F(L)-1	-W	3,000	15,000	---	---	178	390*205*31	120,000	6.964

# Reel Taping Specifications For Surface Mount Devices

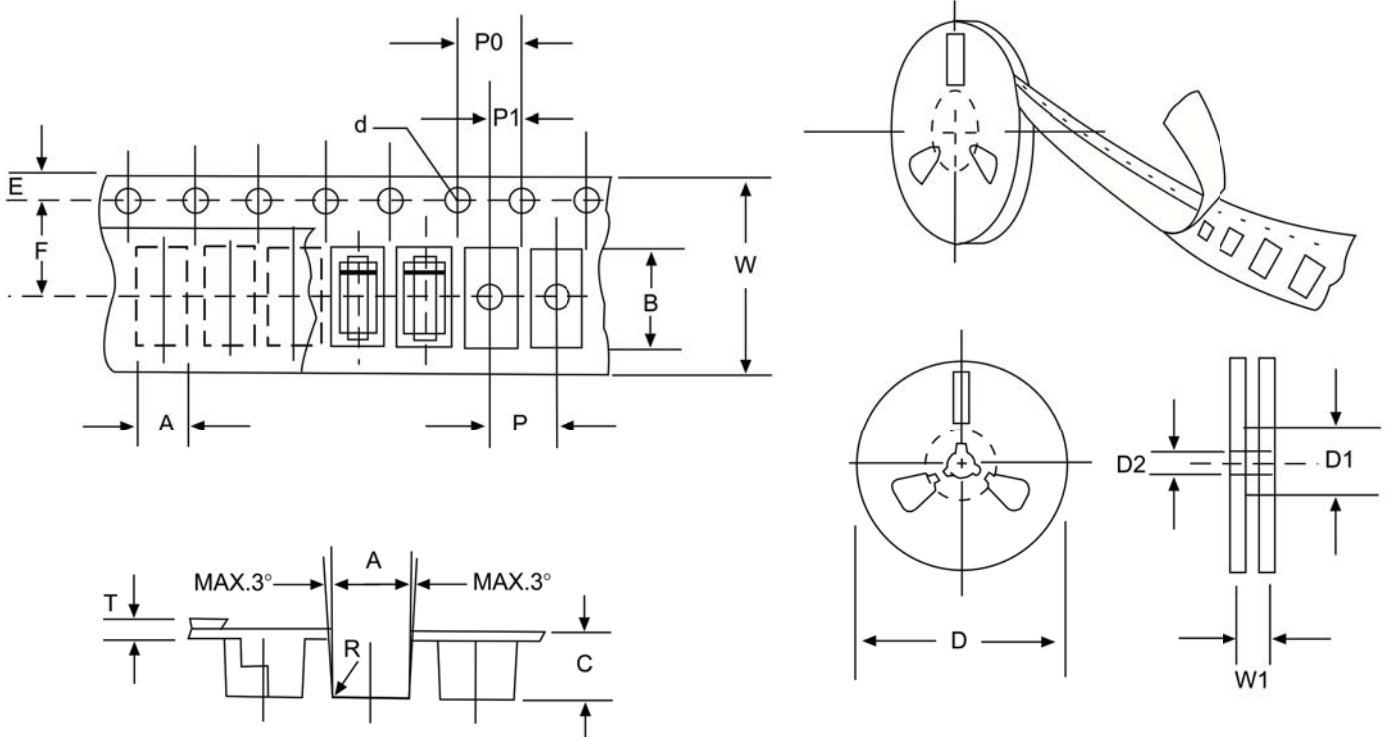

**FIG:CONFIGURATION OF AXIAL TAPING**

ITEM	SYMBOL	SOD-123FLmm(inch)
Carrier width	A	2.05±0.1(0.081±0.004)
Carrier length	B	3.95±0.1(0.156±0.004)
Carrier depth	C	1.45±0.1(0.057±0.004)
Sprocket hole	d	1.55±0.05(0.061±0.002)
Reel outside diameter	D	280/178±2.0(11/7.0±0.079)
Reel inner diameter	D1	50±0.2(1.969±0.008)
Feed hole diameter	D2	13±0.5(0.512±0.020)
Sprocket hole position	E	1.75±0.1(0.069±0.004)
Punch hole position	F	3.50±0.1(0.138±0.002)
Punch hole pitch	P	4.0±0.1(0.157±0.004)
Sprocket hole pitch	P0	4.0±0.1(0.157±0.004)
Embossment center	P1	2.0±0.1(0.079±0.004)
Total tape thickness	T	0.21±0.25(0.008±0.010)
Tape width	W	8.0±0.2(0.315±0.008)
Reel width	W1	10.0±2.0(0.394±0.079)

NOTE:Devices are packde in accordance with EIA standard RS-481-A and specification given above.



## DISCLAIMER NOTICE

Rectron Inc reserves the right to make changes without notice to any product specification herein, to make corrections, modifications, enhancements or other changes. Rectron Inc or anyone on its behalf assumes no responsibility or liability for any errors or inaccuracies. Data sheet specifications and its information contained are intended to provide a product description only. "Typical" parameters which may be included on RECTRON data sheets and/ or specifications can and do vary in different applications and actual performance may vary over time. Rectron Inc does not assume any liability arising out of the application or use of any product or circuit.

Rectron products are not designed, intended or authorized for use in medical, life-saving implant or other applications intended for life-sustaining or other related applications where a failure or malfunction of component or circuitry may directly or indirectly cause injury or threaten a life without expressed written approval of Rectron Inc. Customers using or selling Rectron components for use in such applications do so at their own risk and shall agree to fully indemnify Rectron Inc and its subsidiaries harmless against all claims, damages and expenditures.

## Looking for pricing, stock, or lifecycle information?

Click below to explore more details on WIN SOURCE:

-  [View BZD27C4V3P on WIN SOURCE](#)
-  [Rectron USA Information](#)

## Optimize Your Supply Chain with WIN SOURCE Solutions

-  Global Sourcing Solution
-  Obsolete Management
-  Cost Control Management
-  Shortage Management
-  Alternative Solution
-  Excess Inventory Management