



**THE DATASHEET OF  
BQ76PL536EVM-3**



# ***bq76PL536A and bq76PL536A-Q1 EVM Quick Start Guide***

---

---

---

## **1 Scope**

This document covers the initial connection and installation of the Texas Instruments bq76PL536A and bq76PL536A-Q1 Evaluation Module (EVM), supplied in kit form including the EVM board, the Aardvark USB-SPI adapter, and the connectors to make cells-to-EVM connection. While the EVM includes only bq76PL536A devices, given the very small difference in features between the bq76PL536A and the bq76PL536A-Q1, the EVM can also be used to evaluate the bq76PL536A-Q1. The bq76PL536 EVM Quick Start Guide is not meant as a comprehensive guide to using the bq76PL536A and bq76PL536A-Q1 integrated circuits (ICs) and their features. See the corresponding device data sheets for details ([SLUSAD3](#) and [SLUSAM3](#)).

## **2 Software Installation**

### **2.1 PC Requirements**

1. Pentium® 1.66GHz (Core™2 or better recommended)
2. Windows® .NET™ 2.0 or later, with updates
3. Available USB powered-port (hub OK, if wall adapter used)

### **2.2 Installing the Aardvark Driver**

#### **CAUTION**

The Aardvark driver must be installed before attaching the adapter for the first time.

The Aardvark driver should be installed prior to installing the TI supplied bq76PL536A and bq76PL536A-Q1 Evaluation software.

1. Download the *USB Drivers - Windows* from the Aardvark web site, <http://www.totalphase.com/downloads#aardvark>.
2. Select *USB Drivers - Windows*.
3. A window will open, then select the *USB Drivers - Windows vXXX* link under *Download Software Here*. A registration may be necessary.
4. Go to the location where the file was downloaded and run the file "Tools/Aardvark/Drivers/TotalPhaseUSB-v2.xx.exe" to install the drivers.
5. If prompted to do so, plug in the Aardvark to an available USB port using the supplied cable. The port must be a powered-port, typically directly from a PC. Use of a USB non-powered hub may not provide sufficient operating current for the Aardvark or the EVM to operate correctly.

Pentium is a registered trademark of Intel Corporation.  
.NET is a trademark of Microsoft Corporation.  
Windows is a registered trademark of Microsoft Corporation.  
All other trademarks are the property of their respective owners.

### 2.3 Installing the bq76PL536A and bq76PL536A-Q1 Evaluation Software

Download the bq76PL536A and bq76PL536A-Q1 Evaluation Software from the tool folder on TI.com located here: <http://www.ti.com/tool/BQ76PL536EVM-3-SW>.

Run the file "Software/bq76PL536 Evaluation Software x\_x\_x.msi" to install, where the "x\_x\_x" indicates the current build number. Installation is automatic. This process installs the GUI (Graphical User Interface) software for Windows. As new versions are released, this process may install over the existing version.

## 3 EVM Assembly and Configuration

### 3.1 Configure the Isolated Communications Interface

#### 3.1.1 5-V Versus 3.3-V Selection

In the ISO-COMMS section of the PCB, there are two jumpers. JP5 selects 5-V or 3.3-V I/O operation across the isolation boundary. The Aardvark adapter supplied with the EVM uses 3.3-V logic, but is 5-V tolerant. JP5 should be configured for 3.3-V operation with the supplied Aardvark interface adapter, although either position will work correctly. For connection to a user supplied microcontroller, select the appropriate voltage.

#### 3.1.2 Use USB Power from Aardvark

JP1 selects power from the USB connection through the Aardvark when installed in the "USB" position.

### 3.2 Configure the EVM Board

#### 3.2.1 Use with Cells

Remove jumpers JP1-18 (18) located near the black battery connectors P1-P3 to reduce the current draw of the board. It is OK to leave the jumpers in place; they connect a 1K precision resistor between each adjacent pair of cell inputs and are supplied to use the EVM with power supplies in place of cells (see [Use with ~12-26-VDC Power Supply](#)).

Connect cells to the supplied mating connectors with screw terminals BEFORE plugging the connector into the EVM at P1, the large black connector on the left edge of the board. The most negative cell connects to the most bottom of the black connector (P1).

The bottom-most pin of the battery connector is the most negative connection to the board from the battery stack. This is the negative terminal of cell 1. The next pin in the connector is the positive terminal of cell 1 (and the negative terminal of cell 2). The connections proceed in this fashion up the connector to pin 7, which is the most positive terminal from the battery stack connected to each IC. Pin 7 of P1 (P1.7) is connected to P2.1 on the board. The same is true of P2.7 and P3.1. P3.7 is connected to the top of the PCB (most positive voltage), while P1.1 is connected to the bottom of the PCB (most negative voltage).

The battery connections should be made secure. A loose connection may result in device destruction. Ideally, the cells are connected to one another by secure means such as welding, and only tap points are brought over to the EVM from each cell-to-cell interconnection.

Although the device is immune to the effects of a random connection sequence, the ideal connection sequence is from pin P1.1 to pin 3.7 in order.

TI recommends that users unfamiliar with the EVM and/or li-ion cells begin by using power supplies as outlined in the next section.

### 3.2.2 Use with ~12-26-VDC Power Supply

**Important:** Install jumpers JP1-18 (18) located near the black battery connectors P1-P3 before connecting power supplies. These jumpers connect a precision 0.1% resistor divider network between cell connections.

Connect an appropriate power supply capable of supplying 12-26-VDC to connector P1, then plug P1 into the EVM connector. Any voltage that meets the IC requirements will work; a voltage of 18-24 V is typical of most six-cell systems. Plug additional supplies into P2 and P3. The supplies must be isolated from each other and from earth ground to avoid unintentional short circuits. **A separate supply is required for each IC (each cell-connection plug).**

The supply negative connection is made to pin 1 of the mating connector, the pin that will connect to the bottom-most pin of the mating connector. The positive connection is made to pin 7, the top-most on the connector. It is not necessary to connect to the intermediate pins due to the resistive divider on the EVM which was enabled when JP1-18 were installed

#### CAUTION

Do not remove any of the jumpers JP1-18 while using the EVM in this configuration. Lethal DC voltages may be present for these configurations. Contact with these voltages may result in serious injury or death. Use appropriate safety precautions.

External Power Supply Requirements:

- Nominal Voltage: 18 VDC
- Maximum Current: 50 mA
- Efficiency Level V

---

**NOTE:** TI recommends using an external power supply that complies with applicable regional safety standards such as (by example) UL, CSA, VDE, CCC, PSE, etc.

---

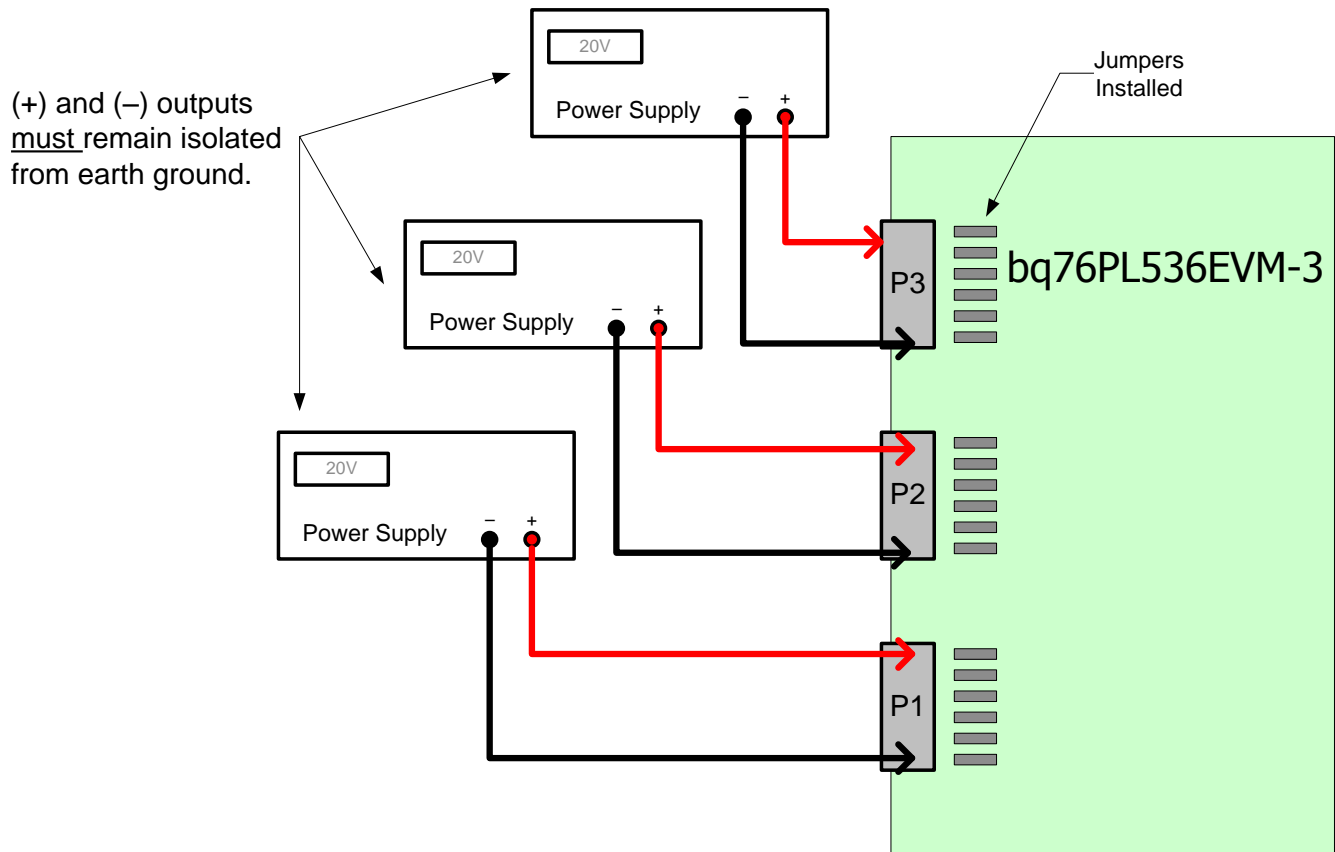

Figure 1. Correct Connection of Three ~20-V Power Supplies to bq76PL536EVM-3

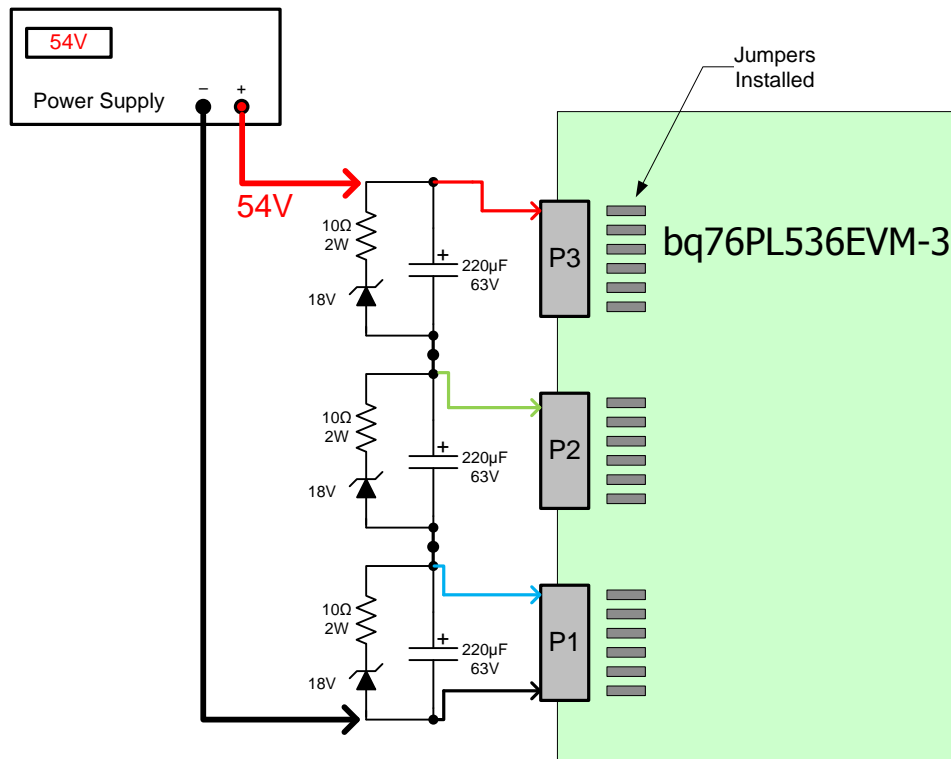

Figure 2. Alternate Connection for a Single 54-V Supply

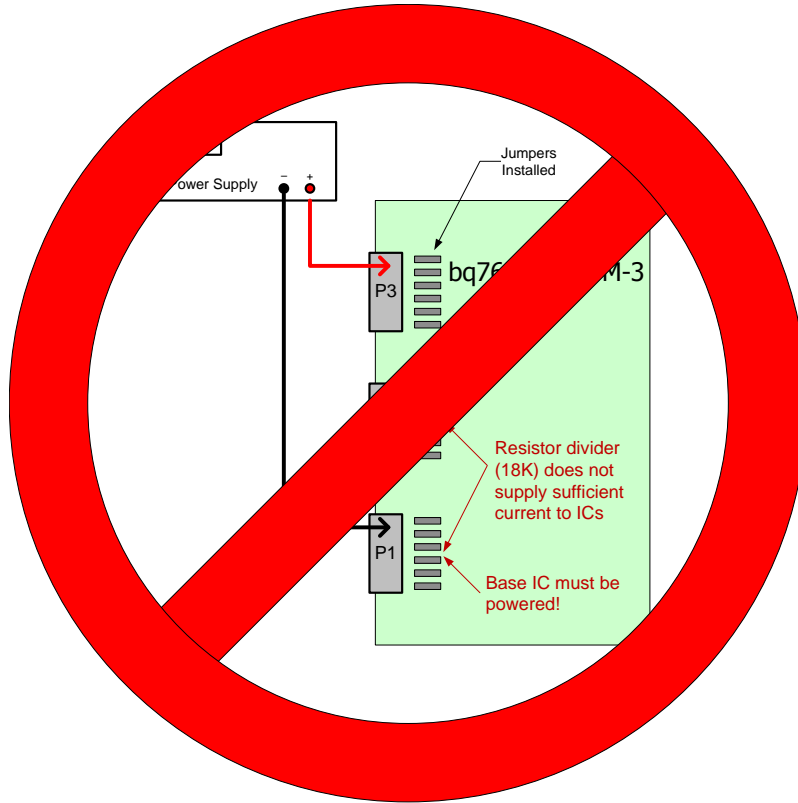

Figure 3. Incorrect Connections, Base IC Not Powered

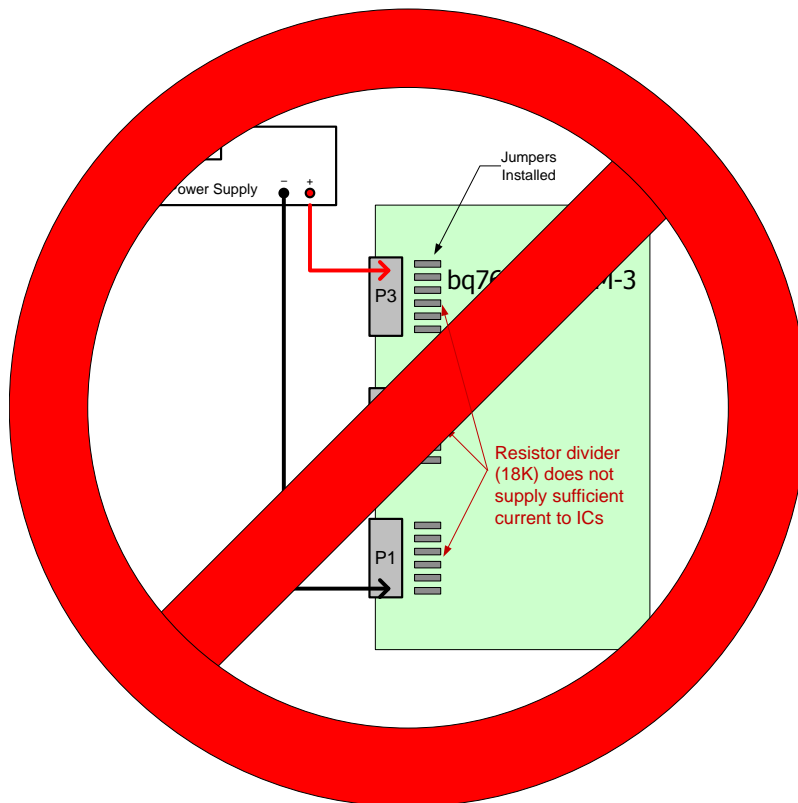
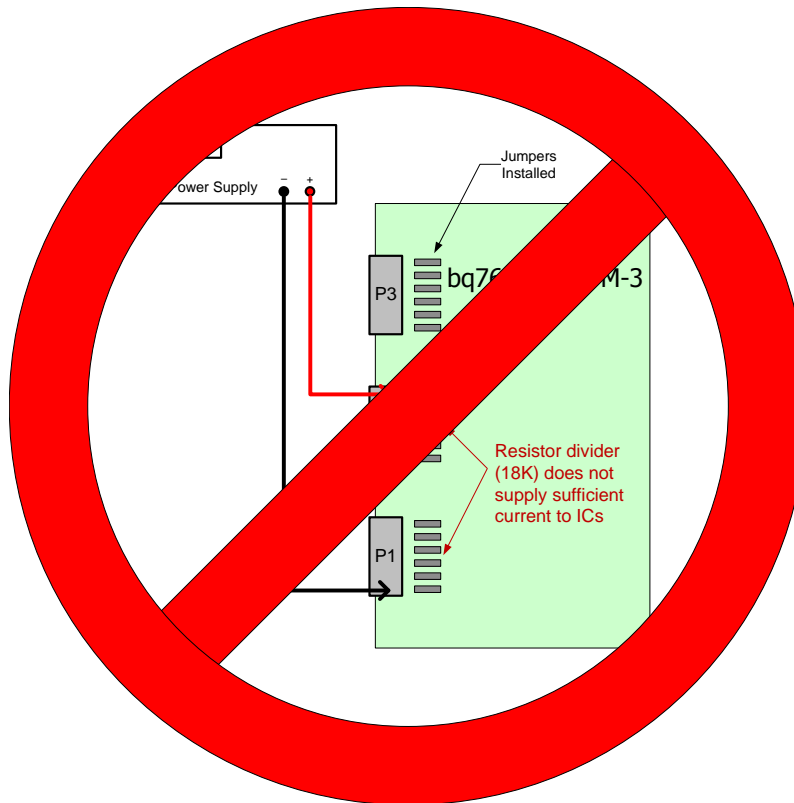

Figure 4. Incorrect Connections, Insufficient  $V_{BAT}$  Per IC



**Figure 5. Incorrect Connections, Top IC Not Powered, IC1, 2 Insufficient  $V_{BAT}$**

### 3.3 Non-Critical Hardware Testing or Firmware Development

#### 3.3.1 Stacking EVMs

For casual testing, one or two devices may be powered (in order from negative to positive) in lieu of powering all three devices. Due to poor termination of the unpowered devices in this configuration, detailed testing or critical hardware evaluations should not be undertaken. Any odd behavior or unexpected fault conditions should be ignored until verified with the EVM correctly powered by three isolated supplies.

## 4 Connecting the EVM

### 4.1 Connection Order

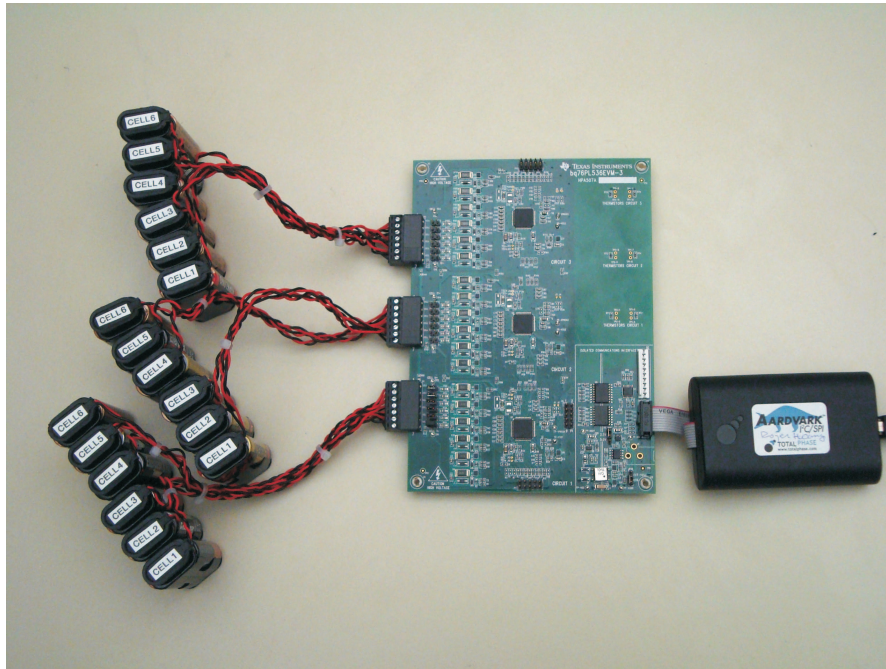

**Figure 6. bq76PL536EVM-3**

- (a) Configure the EVM jumpers per [Section 3.1](#).
- (b) Connect the EVM to the Power Supplies or cells, turn on the supplies at ~12-to-24 V is recommended. The Absolute Maximum voltage per IC is 36 V and should not be exceeded, 30 V is the recommended maximum continuous voltage.
- (c) Connect the USB cable to the Aardvark and your PC.
- (d) Connect the Aardvark ribbon cable to the 10-pin header on the EVM board.
- (e) Start the WinGUI User Interface software supplied with the EVM and installed earlier.

### 4.2 Connection Notes

The ISO-COMMS section of the EVM board isolates the EVM side voltages completely from the PC side. It isolates all power, ground, and signal lines to the EVM. Caution must still be taken when using the EVM as part of a stack, where lethal voltages may be present. The galvanic isolation provided by the ISO-COMMS section does not eliminate the need for safe handling procedures, proper High-Voltage equipment, and protective clothing. Proper safety procedures should always be followed.

Because the ISO-COMMS circuit section fully isolates the PC, Aardvark, and wall adapter from the EVM “battery” side, the Aardvark is insensitive to the powering of the EVM, which receives its power from the battery cells or power supply used for evaluation.

The grounds (VSS) are fully isolated; please keep this in mind when using an oscilloscope or meter. Do not inadvertently connect the EVM VSS to the PC/Aardvark VSS by connecting two probe grounds or otherwise forming a ground loop through external wiring, including the building wiring.

### 4.3 Quick Check

The first step in communicating with the bq76PL536A is to set a unique address for each device in a stack. This is required even if you are only using a single device. This occurs automatically when the Evaluation software is first started. To do this manually, select COMMAND | AUTO ADDRESS (shortcut key CTRL + A). This will cause the software to interrogate the stack of bq76PL536A devices, find all available devices, and assign each a unique address beginning with address 0x01. Address 0x00 is reserved for un-addressed devices.

After addressing is complete, you should see the number of devices found and the total combined voltage of all cells being monitoring displayed in the STACK HEIGHT and V STACK windows.

## 5 Evaluation Software Details

### 5.1 Main Screen

The main screen is divided into four major areas, plus the menu and status bars. The software is referred to as the “Windows Graphical User Interface”, or abbreviated to WinGUI.

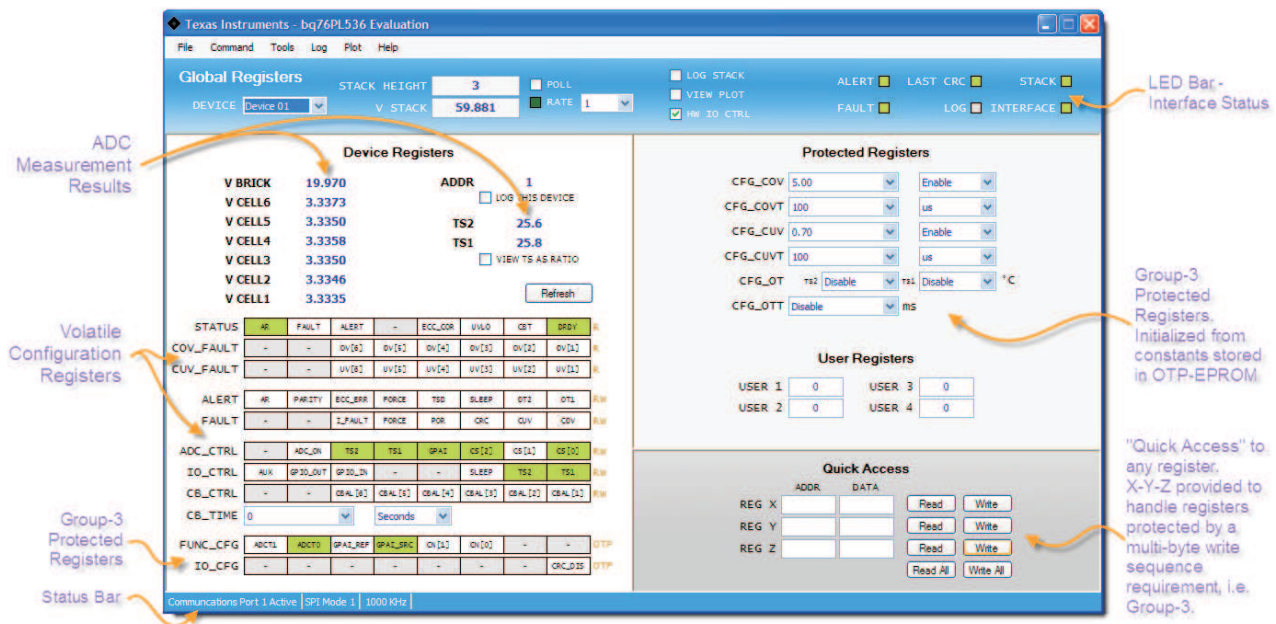

VBRICK

The voltage measured by the bq76PL536A between the BATx and VSS pins

VCELLn

The voltage measured between the pair of pins VCn – VCn-1 (that is, VCELL2 = VC2 – VC1).

ADDR

Displays the address of the device being monitored in the measurement result area.

LOG DEVICE

Checking this box will add the contents of the device at this address to the log file.

TSn

The voltage measured between the TSn+ and TSn- inputs, converted by the WinGUI to temperature based on the characteristics of the thermistor used in the EVM design. The EVM and WinGUI are configured to measure this voltage as a ratio of REG50, which removes any offset or gain errors introduced by drift in the REG50 output.

VIEW AS...

Shows the ratio of the measured input voltage to REG50 as a percentage.

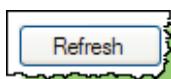

Refresh updates the displayed measurements for this device. The conversion is started by sending the register command CONVERT[CONV]=1, or hardware by toggling the CONV pin if the HW IO CONTROL box is checked.

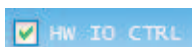

### 5.1.1 Volatile RAM Configuration Registers –

The lower half of this area displays the volatile configuration registers shown as bit fields, see the bq76PL536A or bq76PL536A-Q1 data sheet for details on programming these registers. These registers display green for logic 0 and orange for logic 1. The two states may be toggled between by left-clicking on the bit

The STATUS, COV\_FAULT, and CUV\_FAULT bits are either white (logic 0) or red (logic 1) for asserted. In most cases, the asserted state indicates an error condition sensed by the bq76PL536A.

To clear a fault, first remove the physical condition causing the fault, then click on the ALERT or FAULT bit to reset the state of the bit. This writes a 1 to the bit, followed by a 0, which is the device's method for clearing the asserted bit state back to logic 0.

### 5.1.2 Group-3 Protected Registers –

The device is provided with many configuration options set by bits contained in a special set of registers protected against accidental writing. These RAM registers are initialized from OTP (One-Time Programmable) EPROM cells. The device is shipped with these EPROM locations un-programmed (blank). The Windows GUI interface hides the un-programmed nature of the device by setting defaults in the registers cells when the Evaluation software starts (this can be defeated by setting the TOOLS | OPTIONS defaults). The last settings are also automatically saved by the GUI and restored upon next use. These features are provided for ease of use and are implemented solely in the GUI. Users are responsible for programming OTP bits in parts correctly during manufacturing for correct operation in-circuit.

Some Group-3 registers are shown as registers at the bottom of the left side of the screen, the others in the top right section of the screen as listboxes and registers

### 5.1.3 Quick Access

The Quick Access register(s) provide R/W access to any location in the part. They are named arbitrarily in the GUI 'X', 'Y', and 'Z' – there are no XYZ registers in the part. Some registers, such as the MASTER register require multi-byte writes to “unlock” the target register for writing. To accomplish this, program the X register address/data with the first unlock key, the Y register with the second unlock key, and finally the Z register with the target address and data. Then use the “write all” button to send all three address/data bytes in the correct order and timing to accomplish the multi-byte write. (This is done automatically when using the [Protected Registers](#) window.)

### 5.1.4 LED Status Indicators

At the top right of the user interface screen are 8 status indicator "LED's". These provide a quick view of the status of the devices, and the interface, cable connections, etc. Green normally indicates a logic 0 condition, and red a logic one condition. Gray indicates undefined.

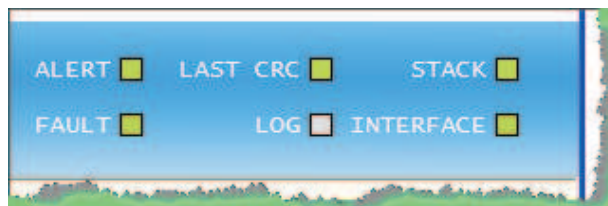

- |       |                                                                                                                                                                                                                                                                                  |
|-------|----------------------------------------------------------------------------------------------------------------------------------------------------------------------------------------------------------------------------------------------------------------------------------|
| ALERT | A condition has been sensed that is causing the ALERT hardware pin to be asserted. This is also indicated by the ALERT bit being set (red) in the [DEVICE] STATUS register. The source of the ALERT condition is indicated in the ALERT register just below the STATUS register. |
| FAULT | Similar to the ALERT indicator, this LED indicates the FAULT bit, and FAULT hardware pin are asserted. The source is indicated in the FAULT register just below the ALERT register.                                                                                              |

- LAST CRC The last CRC received by the GUI was incorrect for the contents of the packet. This usually indicates a communication error caused by improper connection, excessive cabling, etc. The cause of the communication error should be corrected before continuing.
- LOG Green if a log file is being written to. Logging is useful to capture information about cell or interface behavior over long periods of time
- STACK At least one device was found during auto-addressing or rebuild addresses. This indicates that the bottom device in the stack was found, is powered, not in POR, and the ribbon cable from the Aardvark to the EVM is connected correctly. This verifies the cabling and connection all the way to the IC.
- INTERFACE The Aardvark USB-SPI interface adapter was successfully found and communicated with. This verifies the cabling and driver to the adapter.

### 5.1.5 Global Registers

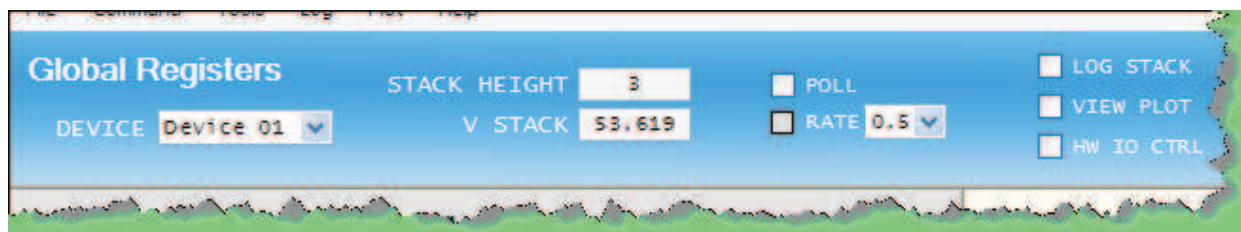

- DEVICE The Address of the device currently being communicated with. Change to access different devices in the stack. “BROADCAST” mode also available to send a single command to all devices in the stack. (In BROADCAST mode, no data are shown – the interface can only display data from one device at a time.
- STACK HT. The number of devices found during the last AUTO-ADDRESS or REBUILD-ADDRESS cycle.
- POLL Check or un-check this box to turn polling on or off. Note that many menu items are unavailable during polling – turn polling off to access them.
- RATE This list box allows choosing a polling rate between 100ms and 60s. The LED illuminates green each time the GUI polls the device stack. Useful as a heartbeat indicator when polling or logging is active. A setting “Fast” is also available. In this position, the WinGUI will poll as fast as possible, with only Windows operating system slowing it down. On most systems, this results in a poll every 10-20ms, but your results may vary depending on the speed of your CPU and other tasks that are running.
- LOG STACK Enables or disables data logging. Logging is to a file in comma-separated-values (.csv) format. Set up logging in the LOG | SETUP menu. Logging may also be started / stopped under the LOG menu. Data are captured each poll, set by the polling interval in TOOLS | INTERFACE.
- VIEW PLOT Check this box to view a dynamic plot of data collected during polling. See [PLOTTING](#) for further information on configuring the plotter.
- HW I/O Check this box to force the Evaluation software to use the hardware pins CONV and DRDY to initiate and monitor ADC conversion cycles, instead of sending commands to the CONVERT\_CTRL[CONV] register bit. Similarly, it is monitoring the FAULT and ALERT hardware pin states to determine a FAULT and/or ALERT condition being present. Note that in HW I/O mode, the REFRESH button toggles the hardware CONV line, but the user may optionally use the CONVERT\_CTRL[CONV] bit to force software initiated conversions by clicking on the bit.

## 5.2 Addressing

The first step in communicating with the bq76PL536A is to set a unique address for each device in the stack. This is required even if you are only using a single device. On the menu, select **COMMAND | AUTO ADDRESS** (shortcut key **CTRL + A**). This will cause the software to interrogate the stack of bq76PL536A devices, find all available devices, and assign each a unique address beginning with address 0x01. Address 0x00 is reserved for un-addressed devices.

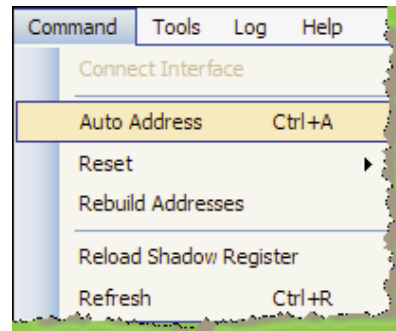

After addressing is complete, the number of devices found and the total combined voltage of all cells being monitoring are displayed in the **STACK HEIGHT** and **V STACK** windows. In this example, two bq76PL536A devices are connected together monitoring 12 cells of about 3.3 V each.

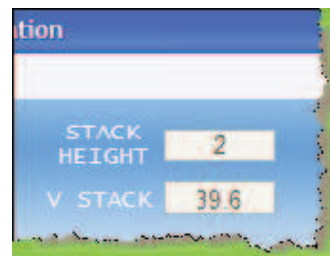

The screen automatically refreshes each time something changes. Addressing the device will cause all displayed values and registers to update. The user should see all cell voltages displayed, along with registers showing **FAULT** and **ALERT** status, **DEVICE STATUS**, etc.

## 5.3 Menus and Commands

### 5.3.1 File Menu

This menu provides a way to save complex register settings between sessions. The settings are saved to a file on the local disk, selected using a dialog box that appears when the Load or Save command is selected. Multiple files, with different settings may be saved under different file names. Saved register settings are then re-loaded from the saved file. All registers – volatile and shadow – are saved or loaded, except the ADC measurements.

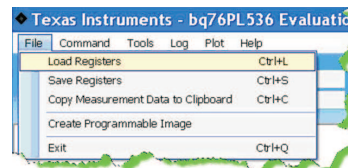

The **Copy Measurement Data to Clipboard** command allows copying the current measurement data (VCn, VBRICK, and TS1, TS2, in that order) to the clipboard, and subsequent copying to a document or spreadsheet. The command will also create EPROM programmable image for bq76PL536A OTP EPROM Programmer.

### 5.3.2 Command Menu

**RESET** allows resetting either the current device, or the entire stack with one command. (Note: The stack is reset using a BROADCAST command packet, whether Broadcast is selected as the current device or not.)

**RELOAD SHADOW REGISTER** will re-initialize the Group-3 Protected Registers from the OTP EPROM. This is useful to verify programming.

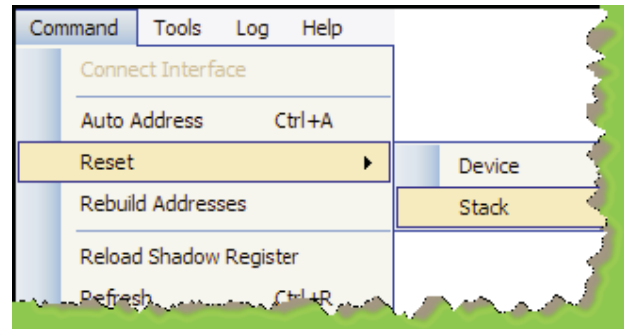

Because the part is shipped unprogrammed, reloading the shadow registers transfers all zeros to the shadow cells, which will usually result in many ALERTS and FAULTS being triggered. These ALERTS and FAULTS are normally hidden by the GUI per the OPTION menu settings (see [Startup Options Dialog](#)).

**REFRESH** updates the screen contents, and is equivalent to the large REFRESH button in the Volatile registers area.

### 5.3.3 Tools Menu

**PROGRAM** opens a dialog box that programs the contents of the shadow registers to the OTP EPROM cells in the bq76PL536A. The data contained in the equivalent address volatile registers are used as the data source. For example, the data in register CONFIG\_OT[] are used to program the EPROM cells which will in turn initialize the CONFIG\_OT[] register at the next RESET.

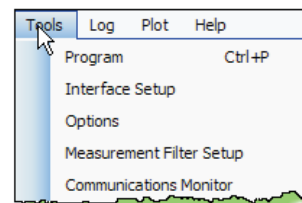

**INTERFACE SETUP** opens a dialog box that allows changing the SPI communications speed.

**OPTIONS** opens a dialog that sets program startup options. These are provided to make the GUI easier to use and to prevent a slew of alarms (FAULTS and ALERTS) at startup. Programmers wishing to check their code will want to disable most of these startup niceties during final code checkout. See [Packing List](#) for details of the startup Options.

**MEASUREMENT FILTER SETUP** opens a listbox that controls filtering of the measurement data. This is a simple LIFO buffer which is then averaged, producing a running average result. The default value is 1 (no filtering), but it can be set from 1 (no filtering) to 20 (heavy filtering).

**COMMUNICATIONS MONITOR** opens the SPI-spy text box. All SPI traffic to and from the bq76PL536A is copied into this box in an easy to read hex format shown below. When first opened, a warning message is displayed advising the user that the monitor should only be used for short periods to avoid consuming too much PC memory. If monitoring traffic for more than a few tens of seconds is needed, use the data logging feature built in to the WinGUI.

SDO data are data sent from the monitored stack to the PC. SDI are data sent from the PC (WinGUI) to the stack of bq76PL536As. The monitor displays all data sent to and from the stack.

The Communications Monitor box shown in [Figure 7](#) displays an error found in communicating with a stack. The error shown is normally encountered by the AUTO\_ADDRESS algorithm used by the WinGUI as it attempts to find all addressed devices – this error results from an attempted poll to a device that does not exist.

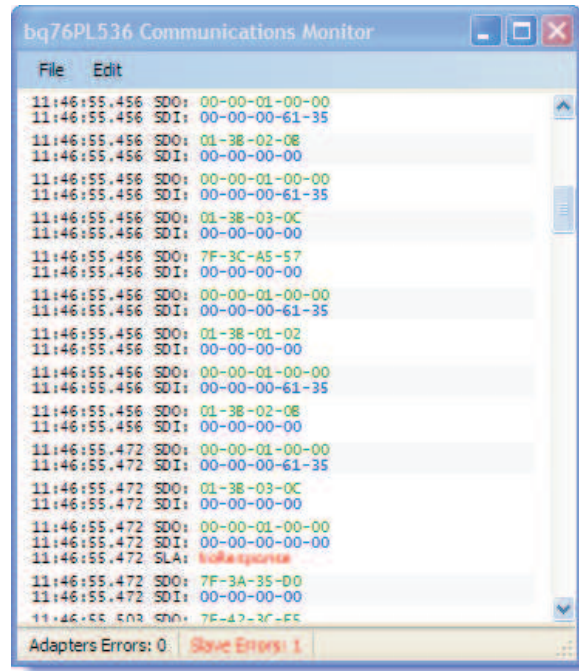
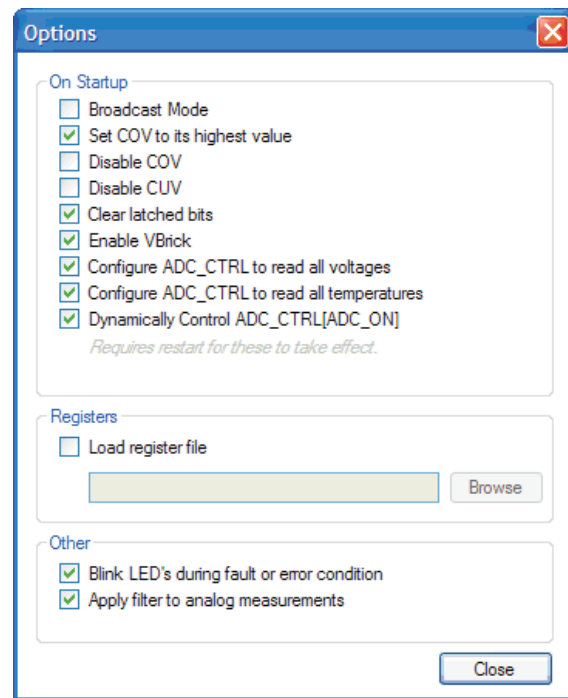

Figure 7. SPI Monitor Showing Communications Error

## 6 Startup Options Dialog

This dialog controls whether or not the WinGUI sets certain options and registers at startup. If a Group-3 register value is affected, the GUI will write a new value to the RAM register after the POR period; the value is not written to the OTP-EPROM. OTP-EPROM is normally shipped blank from the factory. Overwriting these RAM registers at startup prevents many FAULT and ALERT bits from triggering at startup, and it is done as a user convenience.

The option checkboxes are shown below in the state the WinGUI is shipped in. If the user changes any checkbox states, the new defaults are saved automatically when the WinGUI exits.



**BROADCAST MODE**, when checked, brings up the interface set to broadcast messages to all devices, no data are shown. In broadcast mode, the WinGUI does not know which device to read, so no register data are displayed.



If this box is not checked, the interface comes up ready to read/write device 1.



**SET COV [...]** sets the COV threshold to 5.0 V, its highest value

**DISABLE COV** sets the CONFIG\_COV[DISABLE] bit, disabling COV FAULTs

**DISABLE CUV** sets the CONFIG\_CUV[DISABLE] bit, disabling CUV ALERTs

**CLEAR LATCHED BITS** clears all FAULT and ALERT bits latched in the FAULT and ALERT registers, which may have otherwise normally been set by startup conditions, that is, Power-On-Reset

**ENABLE VBRICK** sets the ADC\_CONTROL[GPAI] and FUNC\_CONFIG[GPAI\_SRC] bits. This causes the VBRICK value (BAT-VSS) to be measured on each conversion cycle.

**READ ALL VOLTAGES** sets the bits ADC\_CTRL[CS2:0] to 101b to convert all VCn inputs at each conversion request

**READ ALL TEMPERATURES** sets the bits ADC\_CTRL[TS2:1] to convert both thermistor TSn) inputs at each conversion cycle. It also sets the bits IO\_CTRL[TS2:1] to turn on the thermistor power

**DYNAMICALLY CONTROL ADC\_ON** sets the bits FUNC\_CONFIG[ADCT1:0] to the value 01b, changing the conversion timing from the default 3  $\mu$ s to 6  $\mu$ s. The 6  $\mu$ s setting is recommended for best accuracy. This checkbox also causes the GUI to set the ADC\_CTRL[ADC\_ON] bit before each conversion, convert, then set the ADC\_ON bit back to 0. This is done around each conversion request, whether hardware or software

**LOAD REGISTER FILE** will cause the registers to be pre-loaded with the contents of the file named in the box. This file should be the one saved by the **File | Save Registers** menu selection. This feature can be used to quickly reload a specific configuration back to the devices under test.

**BLINK LED'S** causes the LED indicators in the Global Registers area to blink. If not checked, they stay illuminated RED under error conditions.

**APPLY FILTER** must be checked for the filtering available in the **Tools** menu to be operable. When unchecked, the filter is off (set to 1). Newer versions of the WinGUI (2.1.12 and later) have deleted this option, the filter is controlled directly (and only) from the **Tools | Filter** menu.

## 7 PLOTTING

### 7.1 PLOT MENU

The plot menu allows setting up a simple strip-chart recorder for simple data captures. The data captured to the plot are not automatically captured in a log file. The data are available for use or saving in a variety of formats while the program is running. The plotted data are lost if the program is exited without saving. Logged data are preserved in a file.

**VIEW PLOT** replaces the registers display with the plotter view. It is identical to checking the "View Plot" checkbox in the GLOBAL REGISTERS / LED display area.

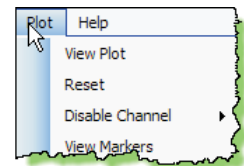

**RESET** completely resets the plotter interface, restoring display defaults and clearing all stored data.

**DISABLE CHANNEL** opens another menu level and allows removal of data channels from the plot.

**VIEW MARKERS** displays a tick at each poll, helping to distinguish polls which return invalid or corrupt data from successful polls.

### 7.2 Plot View

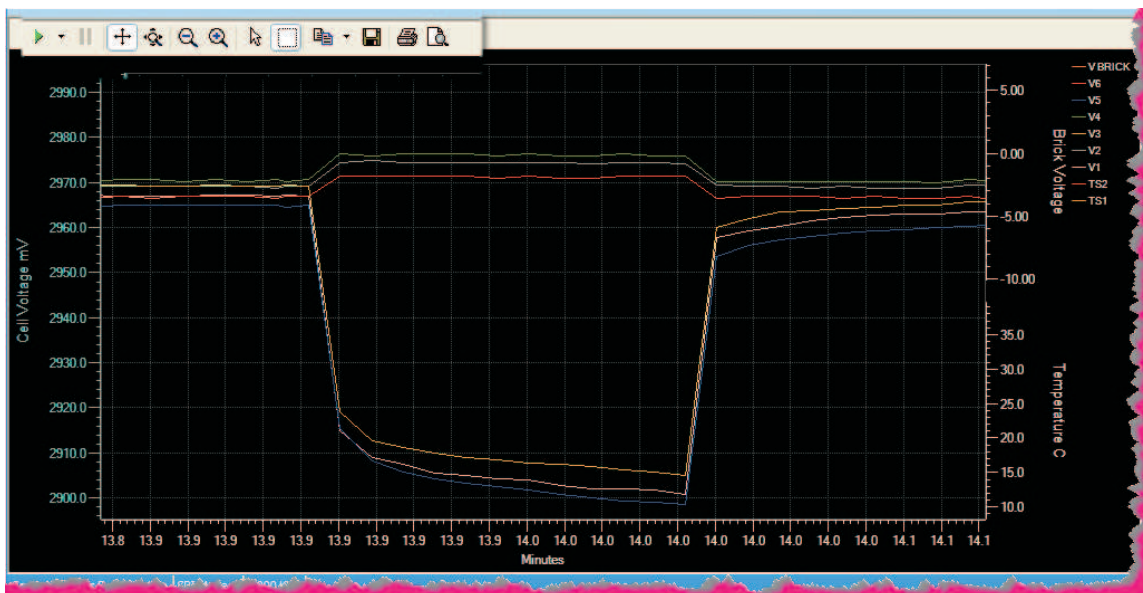

Figure 8. Magnified Window View of the Effect of Cell Balancing for Cells 1-3-5.

### 7.3 Plotter Controls

Plotter controls are shown slightly magnified in the upper left of the capture above. From the left, they control:



**RESUME TRACKING** - causes the strip-chart to resume automatically tracking changes in voltage, time, or temperature – in other words, resume auto-ranging. This green arrow is illuminated after manually zooming in or opening a window in the default view. The default is auto-ranging is enabled. The small black down-arrow opens a small menu of selections controlling the automatic tracking. Whether displayed or not, data are always captured on each poll refresh.



**PAUSE DISPLAY** – momentarily stops auto-tracking. To resume, use the RESUME TRACKING button described above.



**SCROLL X-Y** – After clicking this control, the display (data) window can be moved by left-clicking the mouse button in the display and moving the mouse. Use RESUME TRACKING to restore the display. Each data set (VCn voltages, VBRICK, temperature, time) scale can be individually moved by clicking and holding the left mouse button on the units field and scrolling up-down or left-right (time scale).



**EXPAND X-Y** – This control allows zooming in or out on the displayed scale. Choose this button, then click and hold the left mouse button to operate. Each data set (VCn voltages, VBRICK, temperature, time) scale can be individually zoomed by clicking and holding the left mouse button on the units field and scrolling up-down or left-right (time scale).



**ZOOM OUT** – click on a scale, then click this button to move out in incremental steps.



**ZOOM IN** – similar but opposite action to Zoom out, above.



**SELECT** – allows selecting data or scales (opposite of window mode, described next)



**WINDOW** – click this button, then drag a zoom box around an area in the display to zoom in. This mode is canceled by clicking on the SELECT arrow described above. The display is restored by using the TRACKING RESUME button, above.



**COPY TO CLIPBOARD** – the data are copied to the clipboard for inclusion in a document or spreadsheet. A small menu allows selecting the numeric data to copy, or the graphic.



**SAVE** – the graphic to a .PNG file



**PRINT** – the graphic to a printer



**PRINT PREVIEW** – see what the graphic will look like on your printer before printing.

## 8 Support

Contact the local TI sales office for technical support. Support is also available through the TI E2E™ community forum at [http://e2e.ti.com/support/power\\_management/default.aspx](http://e2e.ti.com/support/power_management/default.aspx)

**TI's Engineer-to-Engineer (E2E) Community.** Created to foster collaboration among engineers. At [e2e.ti.com](http://e2e.ti.com), you can ask questions, share knowledge, explore ideas and help solve problems with fellow engineers.

## 9 Packing List

Line	Quantity	Each	Description
1	1	ea	bq76PL536EVM-3 RevX EVM PCB assembly (x = revision level)
2	1	ea	Aardvark adapter USB→SPI (FW Rev 3.41 or later required)
3	1	ea	USB cable, 1m
4	3	ea	Mating battery connector, 7 pos receptacle
7	20	ea	2 pin jumpers, .025" post, 0.10" cntr
8	1	ea	CD-ROM containing software and documentation

## Revision History

Changes from B Revision (May 2011) to D Revision	Page
• Revision C was deprecated.....	1
• Changed device from bq76PL536 to bq76PL536A.....	1
• Added device part numbers throughout document.....	1
• Changed literature number and added literature number for Q1 device.....	1
• Deleted Windows XP SP2 from PC Requirements.....	1
• Changed Aardvark driver download and installation procedure.....	1
• Changed Evaluation Software installation procedure.....	2
• Changed figure title.....	4
• Deleted requirement to connect Aardvark ribbon cable last.....	7

NOTE: Page numbers for previous revisions may differ from page numbers in the current version.

## Evaluation Board/Kit Important Notice

Texas Instruments (TI) provides the enclosed product(s) under the following conditions:

This evaluation board/kit is intended for use for **ENGINEERING DEVELOPMENT, DEMONSTRATION, OR EVALUATION PURPOSES ONLY** and is not considered by TI to be a finished end-product fit for general consumer use. Persons handling the product(s) must have electronics training and observe good engineering practice standards. As such, the goods being provided are not intended to be complete in terms of required design-, marketing-, and/or manufacturing-related protective considerations, including product safety and environmental measures typically found in end products that incorporate such semiconductor components or circuit boards. This evaluation board/kit does not fall within the scope of the European Union directives regarding electromagnetic compatibility, restricted substances (RoHS), recycling (WEEE), FCC, CE or UL, and therefore may not meet the technical requirements of these directives or other related directives.

Should this evaluation board/kit not meet the specifications indicated in the User's Guide, the board/kit may be returned within 30 days from the date of delivery for a full refund. **THE FOREGOING WARRANTY IS THE EXCLUSIVE WARRANTY MADE BY SELLER TO BUYER AND IS IN LIEU OF ALL OTHER WARRANTIES, EXPRESSED, IMPLIED, OR STATUTORY, INCLUDING ANY WARRANTY OF MERCHANTABILITY OR FITNESS FOR ANY PARTICULAR PURPOSE.**

The user assumes all responsibility and liability for proper and safe handling of the goods. Further, the user indemnifies TI from all claims arising from the handling or use of the goods. Due to the open construction of the product, it is the user's responsibility to take any and all appropriate precautions with regard to electrostatic discharge.

**EXCEPT TO THE EXTENT OF THE INDEMNITY SET FORTH ABOVE, NEITHER PARTY SHALL BE LIABLE TO THE OTHER FOR ANY INDIRECT, SPECIAL, INCIDENTAL, OR CONSEQUENTIAL DAMAGES.**

TI currently deals with a variety of customers for products, and therefore our arrangement with the user **is not exclusive.**

TI assumes **no liability for applications assistance, customer product design, software performance, or infringement of patents or services described herein.**

Please read the User's Guide and, specifically, the Warnings and Restrictions notice in the User's Guide prior to handling the product. This notice contains important safety information about temperatures and voltages. For additional information on TI's environmental and/or safety programs, please contact the TI application engineer or visit [www.ti.com/esh](http://www.ti.com/esh).

No license is granted under any patent right or other intellectual property right of TI covering or relating to any machine, process, or combination in which such TI products or services might be or are used.

## FCC Warning

This evaluation board/kit is intended for use for **ENGINEERING DEVELOPMENT, DEMONSTRATION, OR EVALUATION PURPOSES ONLY** and is not considered by TI to be a finished end-product fit for general consumer use. It generates, uses, and can radiate radio frequency energy and has not been tested for compliance with the limits of computing devices pursuant to part 15 of FCC rules, which are designed to provide reasonable protection against radio frequency interference. Operation of this equipment in other environments may cause interference with radio communications, in which case the user at his own expense will be required to take whatever measures may be required to correct this interference.

## EVM Warnings and Restrictions

It is important to operate this EVM within the input voltage range of 7V to 36V and the output voltage range of 7V to 35V .

Exceeding the specified input range may cause unexpected operation and/or irreversible damage to the EVM. If there are questions concerning the input range, please contact a TI field representative prior to connecting the input power.

Applying loads outside of the specified output range may result in unintended operation and/or possible permanent damage to the EVM. Please consult the EVM User's Guide prior to connecting any load to the EVM output. If there is uncertainty as to the load specification, please contact a TI field representative.

During normal operation, some circuit components may have case temperatures greater than 85°C. The EVM is designed to operate properly with certain components above 85°C as long as the input and output ranges are maintained. These components include but are not limited to linear regulators, switching transistors, pass transistors, and current sense resistors. These types of devices can be identified using the EVM schematic located in the EVM User's Guide. When placing measurement probes near these devices during operation, please be aware that these devices may be very warm to the touch.

Mailing Address: Texas Instruments, Post Office Box 655303, Dallas, Texas 75265  
Copyright © 2015, Texas Instruments Incorporated

## STANDARD TERMS AND CONDITIONS FOR EVALUATION MODULES

1. *Delivery:* TI delivers TI evaluation boards, kits, or modules, including any accompanying demonstration software, components, or documentation (collectively, an "EVM" or "EVMs") to the User ("User") in accordance with the terms and conditions set forth herein. Acceptance of the EVM is expressly subject to the following terms and conditions.
  - 1.1 EVMs are intended solely for product or software developers for use in a research and development setting to facilitate feasibility evaluation, experimentation, or scientific analysis of TI semiconductor products. EVMs have no direct function and are not finished products. EVMs shall not be directly or indirectly assembled as a part or subassembly in any finished product. For clarification, any software or software tools provided with the EVM ("Software") shall not be subject to the terms and conditions set forth herein but rather shall be subject to the applicable terms and conditions that accompany such Software
  - 1.2 EVMs are not intended for consumer or household use. EVMs may not be sold, sublicensed, leased, rented, loaned, assigned, or otherwise distributed for commercial purposes by Users, in whole or in part, or used in any finished product or production system.
2. *Limited Warranty and Related Remedies/Disclaimers:*
  - 2.1 These terms and conditions do not apply to Software. The warranty, if any, for Software is covered in the applicable Software License Agreement.
  - 2.2 TI warrants that the TI EVM will conform to TI's published specifications for ninety (90) days after the date TI delivers such EVM to User. Notwithstanding the foregoing, TI shall not be liable for any defects that are caused by neglect, misuse or mistreatment by an entity other than TI, including improper installation or testing, or for any EVMs that have been altered or modified in any way by an entity other than TI. Moreover, TI shall not be liable for any defects that result from User's design, specifications or instructions for such EVMs. Testing and other quality control techniques are used to the extent TI deems necessary or as mandated by government requirements. TI does not test all parameters of each EVM.
  - 2.3 If any EVM fails to conform to the warranty set forth above, TI's sole liability shall be at its option to repair or replace such EVM, or credit User's account for such EVM. TI's liability under this warranty shall be limited to EVMs that are returned during the warranty period to the address designated by TI and that are determined by TI not to conform to such warranty. If TI elects to repair or replace such EVM, TI shall have a reasonable time to repair such EVM or provide replacements. Repaired EVMs shall be warranted for the remainder of the original warranty period. Replaced EVMs shall be warranted for a new full ninety (90) day warranty period.
3. *Regulatory Notices:*
  - 3.1 *United States*
    - 3.1.1 *Notice applicable to EVMs not FCC-Approved:*

This kit is designed to allow product developers to evaluate electronic components, circuitry, or software associated with the kit to determine whether to incorporate such items in a finished product and software developers to write software applications for use with the end product. This kit is not a finished product and when assembled may not be resold or otherwise marketed unless all required FCC equipment authorizations are first obtained. Operation is subject to the condition that this product not cause harmful interference to licensed radio stations and that this product accept harmful interference. Unless the assembled kit is designed to operate under part 15, part 18 or part 95 of this chapter, the operator of the kit must operate under the authority of an FCC license holder or must secure an experimental authorization under part 5 of this chapter.
    - 3.1.2 *For EVMs annotated as FCC – FEDERAL COMMUNICATIONS COMMISSION Part 15 Compliant:*

### CAUTION

This device complies with part 15 of the FCC Rules. Operation is subject to the following two conditions: (1) This device may not cause harmful interference, and (2) this device must accept any interference received, including interference that may cause undesired operation.

Changes or modifications not expressly approved by the party responsible for compliance could void the user's authority to operate the equipment.

### FCC Interference Statement for Class A EVM devices

*NOTE: This equipment has been tested and found to comply with the limits for a Class A digital device, pursuant to part 15 of the FCC Rules. These limits are designed to provide reasonable protection against harmful interference when the equipment is operated in a commercial environment. This equipment generates, uses, and can radiate radio frequency energy and, if not installed and used in accordance with the instruction manual, may cause harmful interference to radio communications. Operation of this equipment in a residential area is likely to cause harmful interference in which case the user will be required to correct the interference at his own expense.*

## FCC Interference Statement for Class B EVM devices

*NOTE: This equipment has been tested and found to comply with the limits for a Class B digital device, pursuant to part 15 of the FCC Rules. These limits are designed to provide reasonable protection against harmful interference in a residential installation. This equipment generates, uses and can radiate radio frequency energy and, if not installed and used in accordance with the instructions, may cause harmful interference to radio communications. However, there is no guarantee that interference will not occur in a particular installation. If this equipment does cause harmful interference to radio or television reception, which can be determined by turning the equipment off and on, the user is encouraged to try to correct the interference by one or more of the following measures:*

- Reorient or relocate the receiving antenna.
- Increase the separation between the equipment and receiver.
- Connect the equipment into an outlet on a circuit different from that to which the receiver is connected.
- Consult the dealer or an experienced radio/TV technician for help.

### 3.2 Canada

#### 3.2.1 For EVMs issued with an Industry Canada Certificate of Conformance to RSS-210

##### **Concerning EVMs Including Radio Transmitters:**

This device complies with Industry Canada license-exempt RSS standard(s). Operation is subject to the following two conditions: (1) this device may not cause interference, and (2) this device must accept any interference, including interference that may cause undesired operation of the device.

##### **Concernant les EVMs avec appareils radio:**

Le présent appareil est conforme aux CNR d'Industrie Canada applicables aux appareils radio exempts de licence. L'exploitation est autorisée aux deux conditions suivantes: (1) l'appareil ne doit pas produire de brouillage, et (2) l'utilisateur de l'appareil doit accepter tout brouillage radioélectrique subi, même si le brouillage est susceptible d'en compromettre le fonctionnement.

##### **Concerning EVMs Including Detachable Antennas:**

Under Industry Canada regulations, this radio transmitter may only operate using an antenna of a type and maximum (or lesser) gain approved for the transmitter by Industry Canada. To reduce potential radio interference to other users, the antenna type and its gain should be so chosen that the equivalent isotropically radiated power (e.i.r.p.) is not more than that necessary for successful communication. This radio transmitter has been approved by Industry Canada to operate with the antenna types listed in the user guide with the maximum permissible gain and required antenna impedance for each antenna type indicated. Antenna types not included in this list, having a gain greater than the maximum gain indicated for that type, are strictly prohibited for use with this device.

##### **Concernant les EVMs avec antennes détachables**

Conformément à la réglementation d'Industrie Canada, le présent émetteur radio peut fonctionner avec une antenne d'un type et d'un gain maximal (ou inférieur) approuvé pour l'émetteur par Industrie Canada. Dans le but de réduire les risques de brouillage radioélectrique à l'intention des autres utilisateurs, il faut choisir le type d'antenne et son gain de sorte que la puissance isotrope rayonnée équivalente (p.i.r.e.) ne dépasse pas l'intensité nécessaire à l'établissement d'une communication satisfaisante. Le présent émetteur radio a été approuvé par Industrie Canada pour fonctionner avec les types d'antenne énumérés dans le manuel d'usage et ayant un gain admissible maximal et l'impédance requise pour chaque type d'antenne. Les types d'antenne non inclus dans cette liste, ou dont le gain est supérieur au gain maximal indiqué, sont strictement interdits pour l'exploitation de l'émetteur.

### 3.3 Japan

3.3.1 *Notice for EVMs delivered in Japan:* Please see [http://www.tij.co.jp/lstds/ti\\_ja/general/eStore/notice\\_01.page](http://www.tij.co.jp/lstds/ti_ja/general/eStore/notice_01.page) 日本国内に輸入される評価用キット、ボードについては、次のところをご覧ください。  
[http://www.tij.co.jp/lstds/ti\\_ja/general/eStore/notice\\_01.page](http://www.tij.co.jp/lstds/ti_ja/general/eStore/notice_01.page)

3.3.2 *Notice for Users of EVMs Considered "Radio Frequency Products" in Japan:* EVMs entering Japan may not be certified by TI as conforming to Technical Regulations of Radio Law of Japan.

If User uses EVMs in Japan, not certified to Technical Regulations of Radio Law of Japan, User is required by Radio Law of Japan to follow the instructions below with respect to EVMs:

1. Use EVMs in a shielded room or any other test facility as defined in the notification #173 issued by Ministry of Internal Affairs and Communications on March 28, 2006, based on Sub-section 1.1 of Article 6 of the Ministry's Rule for Enforcement of Radio Law of Japan,
2. Use EVMs only after User obtains the license of Test Radio Station as provided in Radio Law of Japan with respect to EVMs, or
3. Use of EVMs only after User obtains the Technical Regulations Conformity Certification as provided in Radio Law of Japan with respect to EVMs. Also, do not transfer EVMs, unless User gives the same notice above to the transferee. Please note that if User does not follow the instructions above, User will be subject to penalties of Radio Law of Japan.

【無線電波を送信する製品の開発キットをお使いになる際の注意事項】 開発キットの中には技術基準適合証明を受けていないものがあります。技術適合証明を受けていないものご使用に際しては、電波法遵守のため、以下のいずれかの措置を取っていただく必要がありますのでご注意ください。

1. 電波法施行規則第6条第1項第1号に基づく平成18年3月28日総務省告示第173号で定められた電波暗室等の試験設備でご使用いただく。
2. 実験局の免許を取得後ご使用いただく。
3. 技術基準適合証明を取得後ご使用いただく。

なお、本製品は、上記の「ご使用にあたっての注意」を譲渡先、移転先に通知しない限り、譲渡、移転できないものとします。

上記を遵守頂けない場合は、電波法の罰則が適用される可能性があることをご留意ください。日本テキサス・インスツルメンツ株式会社  
東京都新宿区西新宿 6 丁目 2 4 番 1 号  
西新宿三井ビル

3.3.3 *Notice for EVMs for Power Line Communication:* Please see [http://www.tij.co.jp/llds/ti\\_ja/general/eStore/notice\\_02.page](http://www.tij.co.jp/llds/ti_ja/general/eStore/notice_02.page)  
電力線搬送波通信についての開発キットをお使いになる際の注意事項については、次のところをご覧ください。[http://www.tij.co.jp/llds/ti\\_ja/general/eStore/notice\\_02.page](http://www.tij.co.jp/llds/ti_ja/general/eStore/notice_02.page)

#### 4 *EVM Use Restrictions and Warnings:*

4.1 EVMS ARE NOT FOR USE IN FUNCTIONAL SAFETY AND/OR SAFETY CRITICAL EVALUATIONS, INCLUDING BUT NOT LIMITED TO EVALUATIONS OF LIFE SUPPORT APPLICATIONS.

4.2 User must read and apply the user guide and other available documentation provided by TI regarding the EVM prior to handling or using the EVM, including without limitation any warning or restriction notices. The notices contain important safety information related to, for example, temperatures and voltages.

#### 4.3 *Safety-Related Warnings and Restrictions:*

4.3.1 User shall operate the EVM within TI's recommended specifications and environmental considerations stated in the user guide, other available documentation provided by TI, and any other applicable requirements and employ reasonable and customary safeguards. Exceeding the specified performance ratings and specifications (including but not limited to input and output voltage, current, power, and environmental ranges) for the EVM may cause personal injury or death, or property damage. If there are questions concerning performance ratings and specifications, User should contact a TI field representative prior to connecting interface electronics including input power and intended loads. Any loads applied outside of the specified output range may also result in unintended and/or inaccurate operation and/or possible permanent damage to the EVM and/or interface electronics. Please consult the EVM user guide prior to connecting any load to the EVM output. If there is uncertainty as to the load specification, please contact a TI field representative. During normal operation, even with the inputs and outputs kept within the specified allowable ranges, some circuit components may have elevated case temperatures. These components include but are not limited to linear regulators, switching transistors, pass transistors, current sense resistors, and heat sinks, which can be identified using the information in the associated documentation. When working with the EVM, please be aware that the EVM may become very warm.

4.3.2 EVMs are intended solely for use by technically qualified, professional electronics experts who are familiar with the dangers and application risks associated with handling electrical mechanical components, systems, and subsystems. User assumes all responsibility and liability for proper and safe handling and use of the EVM by User or its employees, affiliates, contractors or designees. User assumes all responsibility and liability to ensure that any interfaces (electronic and/or mechanical) between the EVM and any human body are designed with suitable isolation and means to safely limit accessible leakage currents to minimize the risk of electrical shock hazard. User assumes all responsibility and liability for any improper or unsafe handling or use of the EVM by User or its employees, affiliates, contractors or designees.

4.4 User assumes all responsibility and liability to determine whether the EVM is subject to any applicable international, federal, state, or local laws and regulations related to User's handling and use of the EVM and, if applicable, User assumes all responsibility and liability for compliance in all respects with such laws and regulations. User assumes all responsibility and liability for proper disposal and recycling of the EVM consistent with all applicable international, federal, state, and local requirements.

5. *Accuracy of Information:* To the extent TI provides information on the availability and function of EVMs, TI attempts to be as accurate as possible. However, TI does not warrant the accuracy of EVM descriptions, EVM availability or other information on its websites as accurate, complete, reliable, current, or error-free.

6. *Disclaimers:*
- 6.1 EXCEPT AS SET FORTH ABOVE, EVMS AND ANY WRITTEN DESIGN MATERIALS PROVIDED WITH THE EVM (AND THE DESIGN OF THE EVM ITSELF) ARE PROVIDED "AS IS" AND "WITH ALL FAULTS." TI DISCLAIMS ALL OTHER WARRANTIES, EXPRESS OR IMPLIED, REGARDING SUCH ITEMS, INCLUDING BUT NOT LIMITED TO ANY IMPLIED WARRANTIES OF MERCHANTABILITY OR FITNESS FOR A PARTICULAR PURPOSE OR NON-INFRINGEMENT OF ANY THIRD PARTY PATENTS, COPYRIGHTS, TRADE SECRETS OR OTHER INTELLECTUAL PROPERTY RIGHTS.
- 6.2 EXCEPT FOR THE LIMITED RIGHT TO USE THE EVM SET FORTH HEREIN, NOTHING IN THESE TERMS AND CONDITIONS SHALL BE CONSTRUED AS GRANTING OR CONFERRING ANY RIGHTS BY LICENSE, PATENT, OR ANY OTHER INDUSTRIAL OR INTELLECTUAL PROPERTY RIGHT OF TI, ITS SUPPLIERS/LICENSORS OR ANY OTHER THIRD PARTY, TO USE THE EVM IN ANY FINISHED END-USER OR READY-TO-USE FINAL PRODUCT, OR FOR ANY INVENTION, DISCOVERY OR IMPROVEMENT MADE, CONCEIVED OR ACQUIRED PRIOR TO OR AFTER DELIVERY OF THE EVM.
7. *USER'S INDEMNITY OBLIGATIONS AND REPRESENTATIONS.* USER WILL DEFEND, INDEMNIFY AND HOLD TI, ITS LICENSORS AND THEIR REPRESENTATIVES HARMLESS FROM AND AGAINST ANY AND ALL CLAIMS, DAMAGES, LOSSES, EXPENSES, COSTS AND LIABILITIES (COLLECTIVELY, "CLAIMS") ARISING OUT OF OR IN CONNECTION WITH ANY HANDLING OR USE OF THE EVM THAT IS NOT IN ACCORDANCE WITH THESE TERMS AND CONDITIONS. THIS OBLIGATION SHALL APPLY WHETHER CLAIMS ARISE UNDER STATUTE, REGULATION, OR THE LAW OF TORT, CONTRACT OR ANY OTHER LEGAL THEORY, AND EVEN IF THE EVM FAILS TO PERFORM AS DESCRIBED OR EXPECTED.
8. *Limitations on Damages and Liability:*
- 8.1 *General Limitations.* IN NO EVENT SHALL TI BE LIABLE FOR ANY SPECIAL, COLLATERAL, INDIRECT, PUNITIVE, INCIDENTAL, CONSEQUENTIAL, OR EXEMPLARY DAMAGES IN CONNECTION WITH OR ARISING OUT OF THESE TERMS AND CONDITIONS OR THE USE OF THE EVMS PROVIDED HEREUNDER, REGARDLESS OF WHETHER TI HAS BEEN ADVISED OF THE POSSIBILITY OF SUCH DAMAGES. EXCLUDED DAMAGES INCLUDE, BUT ARE NOT LIMITED TO, COST OF REMOVAL OR REINSTALLATION, ANCILLARY COSTS TO THE PROCUREMENT OF SUBSTITUTE GOODS OR SERVICES, RETESTING, OUTSIDE COMPUTER TIME, LABOR COSTS, LOSS OF GOODWILL, LOSS OF PROFITS, LOSS OF SAVINGS, LOSS OF USE, LOSS OF DATA, OR BUSINESS INTERRUPTION. NO CLAIM, SUIT OR ACTION SHALL BE BROUGHT AGAINST TI MORE THAN ONE YEAR AFTER THE RELATED CAUSE OF ACTION HAS OCCURRED.
- 8.2 *Specific Limitations.* IN NO EVENT SHALL TI'S AGGREGATE LIABILITY FROM ANY WARRANTY OR OTHER OBLIGATION ARISING OUT OF OR IN CONNECTION WITH THESE TERMS AND CONDITIONS, OR ANY USE OF ANY TI EVM PROVIDED HEREUNDER, EXCEED THE TOTAL AMOUNT PAID TO TI FOR THE PARTICULAR UNITS SOLD UNDER THESE TERMS AND CONDITIONS WITH RESPECT TO WHICH LOSSES OR DAMAGES ARE CLAIMED. THE EXISTENCE OF MORE THAN ONE CLAIM AGAINST THE PARTICULAR UNITS SOLD TO USER UNDER THESE TERMS AND CONDITIONS SHALL NOT ENLARGE OR EXTEND THIS LIMIT.
9. *Return Policy.* Except as otherwise provided, TI does not offer any refunds, returns, or exchanges. Furthermore, no return of EVM(s) will be accepted if the package has been opened and no return of the EVM(s) will be accepted if they are damaged or otherwise not in a resalable condition. If User feels it has been incorrectly charged for the EVM(s) it ordered or that delivery violates the applicable order, User should contact TI. All refunds will be made in full within thirty (30) working days from the return of the components(s), excluding any postage or packaging costs.
10. *Governing Law:* These terms and conditions shall be governed by and interpreted in accordance with the laws of the State of Texas, without reference to conflict-of-laws principles. User agrees that non-exclusive jurisdiction for any dispute arising out of or relating to these terms and conditions lies within courts located in the State of Texas and consents to venue in Dallas County, Texas. Notwithstanding the foregoing, any judgment may be enforced in any United States or foreign court, and TI may seek injunctive relief in any United States or foreign court.

Mailing Address: Texas Instruments, Post Office Box 655303, Dallas, Texas 75265  
Copyright © 2015, Texas Instruments Incorporated

## IMPORTANT NOTICE

Texas Instruments Incorporated and its subsidiaries (TI) reserve the right to make corrections, enhancements, improvements and other changes to its semiconductor products and services per JESD46, latest issue, and to discontinue any product or service per JESD48, latest issue. Buyers should obtain the latest relevant information before placing orders and should verify that such information is current and complete. All semiconductor products (also referred to herein as "components") are sold subject to TI's terms and conditions of sale supplied at the time of order acknowledgment.

TI warrants performance of its components to the specifications applicable at the time of sale, in accordance with the warranty in TI's terms and conditions of sale of semiconductor products. Testing and other quality control techniques are used to the extent TI deems necessary to support this warranty. Except where mandated by applicable law, testing of all parameters of each component is not necessarily performed.

TI assumes no liability for applications assistance or the design of Buyers' products. Buyers are responsible for their products and applications using TI components. To minimize the risks associated with Buyers' products and applications, Buyers should provide adequate design and operating safeguards.

TI does not warrant or represent that any license, either express or implied, is granted under any patent right, copyright, mask work right, or other intellectual property right relating to any combination, machine, or process in which TI components or services are used. Information published by TI regarding third-party products or services does not constitute a license to use such products or services or a warranty or endorsement thereof. Use of such information may require a license from a third party under the patents or other intellectual property of the third party, or a license from TI under the patents or other intellectual property of TI.

Reproduction of significant portions of TI information in TI data books or data sheets is permissible only if reproduction is without alteration and is accompanied by all associated warranties, conditions, limitations, and notices. TI is not responsible or liable for such altered documentation. Information of third parties may be subject to additional restrictions.

Resale of TI components or services with statements different from or beyond the parameters stated by TI for that component or service voids all express and any implied warranties for the associated TI component or service and is an unfair and deceptive business practice. TI is not responsible or liable for any such statements.

Buyer acknowledges and agrees that it is solely responsible for compliance with all legal, regulatory and safety-related requirements concerning its products, and any use of TI components in its applications, notwithstanding any applications-related information or support that may be provided by TI. Buyer represents and agrees that it has all the necessary expertise to create and implement safeguards which anticipate dangerous consequences of failures, monitor failures and their consequences, lessen the likelihood of failures that might cause harm and take appropriate remedial actions. Buyer will fully indemnify TI and its representatives against any damages arising out of the use of any TI components in safety-critical applications.

In some cases, TI components may be promoted specifically to facilitate safety-related applications. With such components, TI's goal is to help enable customers to design and create their own end-product solutions that meet applicable functional safety standards and requirements. Nonetheless, such components are subject to these terms.

No TI components are authorized for use in FDA Class III (or similar life-critical medical equipment) unless authorized officers of the parties have executed a special agreement specifically governing such use.

Only those TI components which TI has specifically designated as military grade or "enhanced plastic" are designed and intended for use in military/aerospace applications or environments. Buyer acknowledges and agrees that any military or aerospace use of TI components which have **not** been so designated is solely at the Buyer's risk, and that Buyer is solely responsible for compliance with all legal and regulatory requirements in connection with such use.

TI has specifically designated certain components as meeting ISO/TS16949 requirements, mainly for automotive use. In any case of use of non-designated products, TI will not be responsible for any failure to meet ISO/TS16949.

### Products

Audio	<a href="http://www.ti.com/audio">www.ti.com/audio</a>
Amplifiers	<a href="http://amplifier.ti.com">amplifier.ti.com</a>
Data Converters	<a href="http://dataconverter.ti.com">dataconverter.ti.com</a>
DLP® Products	<a href="http://www.dlp.com">www.dlp.com</a>
DSP	<a href="http://dsp.ti.com">dsp.ti.com</a>
Clocks and Timers	<a href="http://www.ti.com/clocks">www.ti.com/clocks</a>
Interface	<a href="http://interface.ti.com">interface.ti.com</a>
Logic	<a href="http://logic.ti.com">logic.ti.com</a>
Power Mgmt	<a href="http://power.ti.com">power.ti.com</a>
Microcontrollers	<a href="http://microcontroller.ti.com">microcontroller.ti.com</a>
RFID	<a href="http://www.ti-rfid.com">www.ti-rfid.com</a>
OMAP Applications Processors	<a href="http://www.ti.com/omap">www.ti.com/omap</a>
Wireless Connectivity	<a href="http://www.ti.com/wirelessconnectivity">www.ti.com/wirelessconnectivity</a>

### Applications

Automotive and Transportation	<a href="http://www.ti.com/automotive">www.ti.com/automotive</a>
Communications and Telecom	<a href="http://www.ti.com/communications">www.ti.com/communications</a>
Computers and Peripherals	<a href="http://www.ti.com/computers">www.ti.com/computers</a>
Consumer Electronics	<a href="http://www.ti.com/consumer-apps">www.ti.com/consumer-apps</a>
Energy and Lighting	<a href="http://www.ti.com/energy">www.ti.com/energy</a>
Industrial	<a href="http://www.ti.com/industrial">www.ti.com/industrial</a>
Medical	<a href="http://www.ti.com/medical">www.ti.com/medical</a>
Security	<a href="http://www.ti.com/security">www.ti.com/security</a>
Space, Avionics and Defense	<a href="http://www.ti.com/space-avionics-defense">www.ti.com/space-avionics-defense</a>
Video and Imaging	<a href="http://www.ti.com/video">www.ti.com/video</a>

### TI E2E Community

[e2e.ti.com](http://e2e.ti.com)

## Looking for pricing, stock, or lifecycle information?

Click below to explore more details on WIN SOURCE:

 [View BQ76PL536EVM-3 on WIN SOURCE](#)

 [Texas Instruments](#) Information

## Optimize Your Supply Chain with WIN SOURCE Solutions

-  Global Sourcing Solution
-  Obsolete Management
-  Cost Control Management
-  Shortage Management
-  Alternative Solution
-  Excess Inventory Management