



**THE DATASHEET OF
BQ76PL455EVM**



bq76PL455EVM and GUI User Guide

This document describes the functionality and the required setup steps to use the bq76PL455EVM. Instructions for installing and operating the bq76PL455A-Q1 Graphical User Interface (GUI) are provided as well as directions for connecting and powering the bq76PL455EVM on and off.

Contents

1	General Description	3
2	Features.....	3
3	Electrical Characteristics.....	4
4	Application	4
	4.1 Cell Voltage Monitoring	6
	4.2 Cell Undervoltage and Overvoltage Comparators.....	7
	4.3 Temperature and Auxiliary Signal Monitoring.....	7
	4.4 Cell Balancing	7
	4.5 Embedded Control Logic	7
	4.6 Communications	8
	4.7 Fault	9
	4.8 Wake and Power Down	9
	4.9 Power Supplies	9
5	Hardware	10
	5.1 Switches	10
	5.2 Connectors	12
	5.3 Test Points	16
6	Getting Started with the bq76PL455EVM	17
	6.1 Software Drivers.....	17
	6.2 GUI	17
	6.3 Recommended PC Requirements	17
	6.4 Installation Instructions	18
	6.5 Configuring a Single bq76PL455EVM.....	21
	6.6 Connecting and Powering the bq76PL455EVM.....	22
	6.7 Configuring Stacked bq76PL455EVMs.....	23
	6.8 Connecting and Powering Stacked bq76PL455EVMs	23
7	Software	23
	7.1 Using the Software	23
	7.2 Setup Tab	27
	7.3 Register View Window.....	28
	7.4 Comms Tab	30
	7.5 Thresholds Tab	32
	7.6 Cells Tab	33
	7.7 Aux and I/O Tab	33
	7.8 Balancing Tab	34
	7.9 Fault Mask Tab	35
	7.10 Faults Tab	36
	7.11 Logging Tab.....	37
	7.12 Stopping and Starting Polling and Balancing.....	39

Core 2 Duo, VPro are trademarks of Intel Corporation.
Intel is a registered trademark of Intel Corporation.
Microsoft, Windows, Excel are registered trademarks of Microsoft Corporation.

7.13	Manual Command Window Extension.....	41
7.14	Sections of the Manual Command Window Extension.....	42
7.15	Script File Format	51
7.16	Shutting Down	52
Appendix A	Log Files.....	53
Appendix B	Bill of Materials	58
Appendix C	Schematics.....	61

List of Figures

1	bq76PL455EVM Board Photo.....	4
2	bq76PL455A-Q1 Functional Block Diagram.....	6
3	Install Wizard.....	18
4	Software License Agreement Acceptance	19
5	GUI Install Location Selection	19
6	GUI Installation Confirmation	20
7	GUI Installation Progress.....	20
8	GUI Installation Completion	21
9	Single bq76PL455EVM Switch Configuration	22
10	COM Selection Window	24
11	COM Selection Window Options	24
12	Auto-Addressing.....	24
13	Initial View/Setup Tab.....	25
14	Register View	28
15	EEPROM Save Warning	29
16	Comms Tab	30
17	Sampling Tab	31
18	Thresholds Tab	32
19	Cells Tab	33
20	Aux and I/O Tab	34
21	Balancing Tab	35
22	Fault Mask Tab	36
23	Faults Tab	37
24	Logging Tab, Auto File Name	38
25	Logging Tab, User-Specified File Name	38
26	Cell 10 Balancing Example	39
27	Aborted Balancing Due to UV Fault	40
28	Balancing during UV Fault	41
29	Manual Communications Window.....	42
30	Ready to Load Previously Saved Script.....	44
31	Load Script Selection Window.....	45
32	Loaded Script in Command Window	46
33	Broadcast Command Responses	47
34	Manual Command Entry Help	48
35	Script Assignment Window.....	48
36	Script Selection Window.....	49
37	Ready to Assign Script to Button.....	49
38	Script Assigned to Button	50
39	Sample Script.....	51
40	Script with Comments	51
41	Example Script with Delay	52

42	bq76PL455EVM Schematic - Sheet 1	62
43	bq76PL455EVM Schematic - Sheet 2	63
44	bq76PL455EVM Schematic - Sheet 3	64
45	bq76PL455EVM Schematic - Sheet 4	65

List of Tables

1	Switch Settings for Sample Rates	11
2	Battery Connector Pin Assignments	12
3	J4 - Diff Comm Low Connector Pin Assignments.....	13
4	J5 - Diff Comm High Connector Pin Assignments	13
5	J3 - Serial Connector Pin Assignments	14
6	J2 -Thermistor Connector Pin Assignments	14
7	P1 - GPIO Header Pin Assignments.....	15
8	bq76PL455EVM Test Points.....	16

1 General Description

Texas Instruments' passive balancing bq76PL455A-Q1 provides monitoring and balancing for a stack of up to 16 series-connected lithium-ion battery cells. The bq76PL455A-Q1 operates on stack voltages from a 16 V minimum to a 79.2 V maximum. In addition to 16 battery cell measurement channels, eight (8) additional analog channels are provided for temperature or auxiliary signal sensing, and six (6) additional digital channels are provided. As an option, configure the digital channels to generate faults when the level changes state; either high to low, or low to high. Please refer to the bq76PL455A-Q1 data sheet ([SLUSC51](#)) for specification of channel voltage measurement accuracy over the 0 to 65°C and –40°C to 105°C operating temperature ranges. The passive cell balancing current is set by onboard resistors to 56 mA for a cell at 4.2 V.

For battery stacks with more than 16 cells, stack up to 6 bq76PL455EVMs, in series, to support up to 96 cells. Communication with stacked bq76PL455EVMs is via an isolated daisy chain differential bus capable of withstanding 500 V. A stack of multiple bq76PL455EVMs can be woken from power down using a single wake command from the GUI. *System Faults* are monitored and indicated in the GUI by simulated LED fault indicators.

Control a single EVM or multiple stacked bq76PL455EVMs using a PC-hosted GUI. Communication between the PC and the lowest in a stack of bq76PL455EVMs is via an FTDI USB-to-TTL (5V) serial interface cable. Communication between all other EVMs in the stack is via the isolated, daisy chain differential communication bus. The PC GUI allows configuration of the bq76PL455EVMs to monitor cells and other analog data channels, control balancing, and monitor details of any faults.

The bq76PL455EVM ([Figure 1](#)) demonstrates the performance of Texas Instrument's new highly integrated bq76PL455A-Q1 16-cell, battery stack monitoring, passive balancing device. The bq76PL455A-Q1 provides a highly accurate, reliable, and robust solution for battery management, integrating all of the following components:

- 14-bit Analog-to-Digital Converter (ADC)
- Precision voltage reference
- Precision, high-voltage Analog Front End (AFE)
- Universal asynchronous receiver/transceiver (UART) serial communication interface
- LDO voltage regulator
- Control logic for monitoring, balancing, and communication functions

2 Features

The features for the bq76PL455EVM include:

- 16-channel precision voltage cell monitoring and passive balancing
- 8-channel temperature or auxiliary signal monitoring

- 6-channel digital signal monitoring, with optional fault monitoring
- Isolated serial communications
- Stackable, supporting up to 96 cells

3 Electrical Characteristics

The electrical characteristics are shown in the following list:

- Operating voltage range 16 V to 79.2 V
- Measures up to 16 cells from 1 V to 5 V
 - Absolute maximum cell open circuit voltage 5.5 V
- Balancing current up to 56 mA at 4.2 V
- Operating temperature -40°C to 105°C

Figure 1 is a photograph of the bq76PL455EVM board.

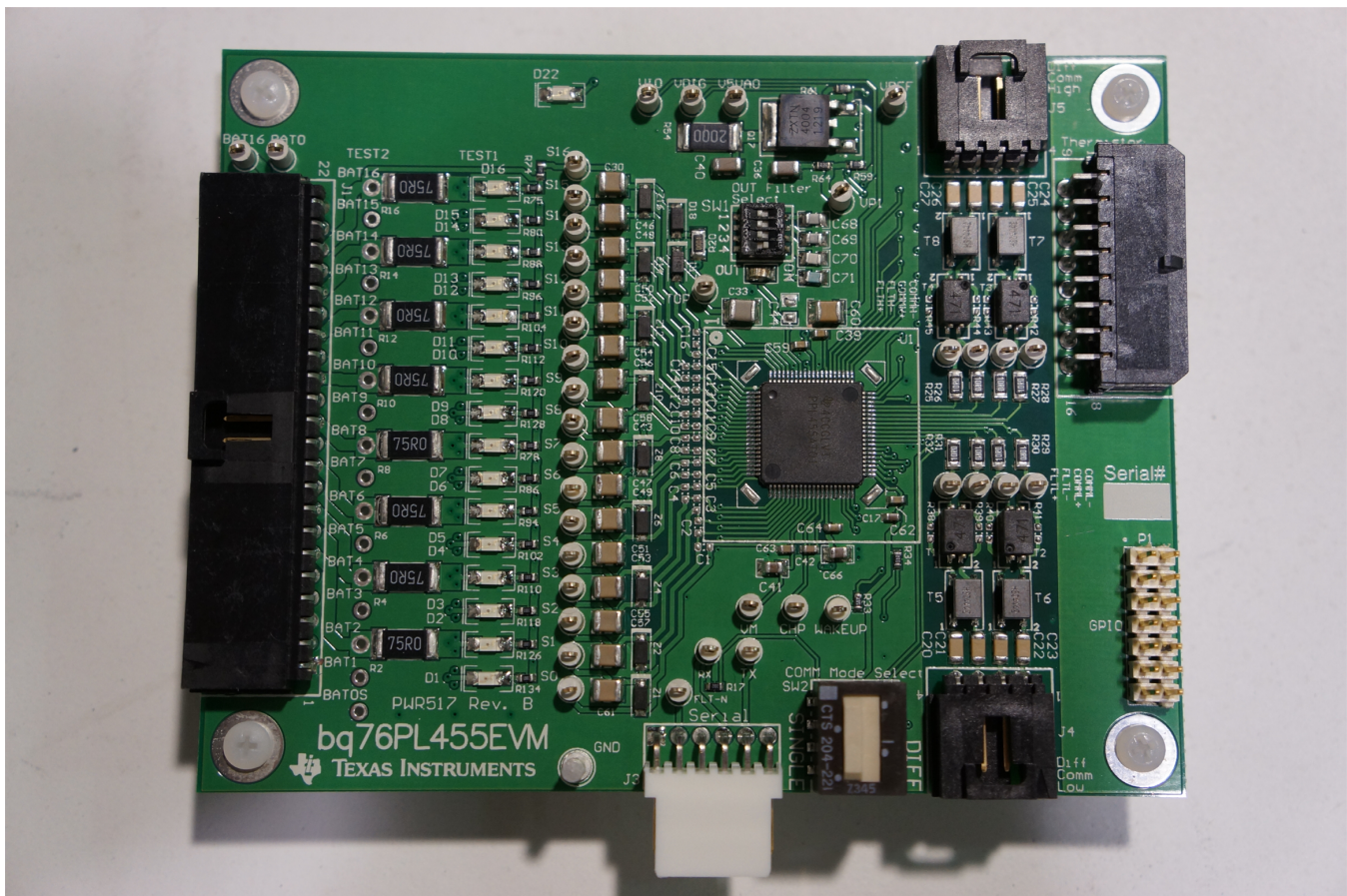

Figure 1. bq76PL455EVM Board Photo

4 Application

TI's integrated passive balancing evaluation module is designed to monitor and balance battery cells to ensure safe and reliable operation. Energy storage systems can be severely impacted by improper management of the charge and discharge cycles of the employed battery cells. Over time, charge and discharge cycling causes individual variations in the voltage, charge capacity and internal impedance of the battery pack cells, leading to reduced effective capacity and lower efficiency.

If cells are mismatched by charge and discharge cycling, aging, or errors in manufacturing, then the cells can easily be pushed beyond their rated operating voltage range by further charge and discharge cycles, causing permanent damage and compromising pack performance. Using the bq76PL455A-Q1 monitoring and balancing system, the individual battery pack cells are brought to the same voltage to optimize battery pack charge storage, lifetime, and application run time on a single charge.

The bq76PL455EVM implements the following functions:

- Cell voltage monitoring
- Cell UV and OV comparators
- Cell balancing
- Temperature and auxiliary signal monitoring
- Embedded control
- Fault monitoring
- Isolated differential daisy chain communications
- PC serial communications
- General purpose I/O
- Power supply

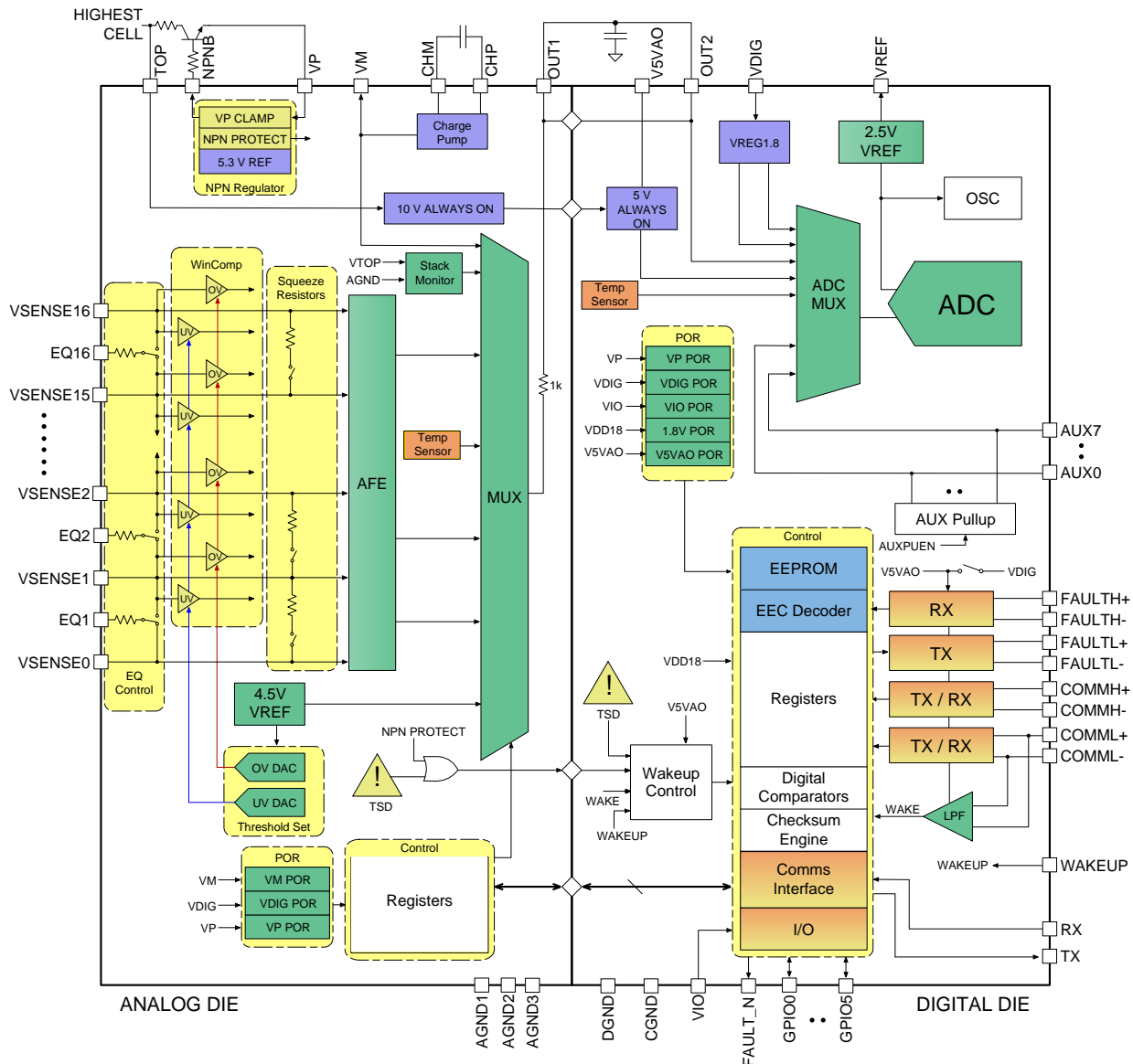

Figure 2. bq76PL455A-Q1 Functional Block Diagram

4.1 Cell Voltage Monitoring

The TI bq76PL455A-Q1 integrated balancing solution supports high-accuracy, high-speed cell voltage measurement. The whole measurement subsystem is designed for high-accuracy measurements while providing low-power operation. The cell monitoring block utilizes a high-voltage, high-accuracy AFE and a 14-bit ADC. The bq76PL455A-Q1 is capable of monitoring up to 16 cells from a minimum stack voltage of 16 V up to a maximum stack voltage of 79.2 V. Each channel is capable of measuring cell voltage over an operating range of 1 V to 5 V.

The bq76PL455A-Q1 can be programmed to sample any combination of its selected channels in descending order, with sampling times between 4.13 μ s and 1000.08 μ s. To reduce noise on measurements, set the bq76PL455A-Q1 to oversample up to 32 times and respond back with the average sampled value from each channel during the averaging. Using the PC GUI, set the bq76PL455EVM to continuously poll the programmed channels at various rates, depending on the averaging period selected. Whenever user-specified under- or over-voltage thresholds are exceeded by measured cell voltages, fault register bits are set indicating one or more faults. Active faults can be selectively programmed to trigger the bq76PL455A-Q1 FAULT output pin, if a limit is exceeded.

4.2 Cell Undervoltage and Overvoltage Comparators

An independent bank of comparators with their own separate undervoltage and overvoltage limits provides additional cell voltage monitoring and FAULT line control.

4.3 Temperature and Auxiliary Signal Monitoring

The bq76PL455A-Q1 supports eight temperature and auxiliary channels. The bq76PL455EVM implements a connector for all of these channels, in order to test remote temperature and auxiliary signal monitoring. Negative thermal coefficient (NTC) thermistors or external signals can be connected to the bq76PL455EVM's 8x2 pin right angle temperature sense J2 - Thermistor connector. Separate undervoltage and overvoltage limits can be set for each of the eight temperature/auxiliary channels. If these limits are reached, a fault is flagged.

10-k Ω pull up resistors are fitted to support NTC use. Choose a thermistor, depending on the application and need and change the 10-k Ω pull-up resistors, as required.

4.4 Cell Balancing

Based on the cell voltage data, the main system controller can determine when individual cells reach their maximum limit during charging. Without passive balancing, if an individual cell reaches its maximum voltage, then stack charging should stop to prevent overcharging and damaging that cell. However, that leaves other cells in the same series string less than 100% charged if all of the cells are not evenly matched and do not reach maximum charge at the same time. Premature termination of stack charging due to an individual cell reaching maximum voltage leaves the stack inefficiently charged to less than its theoretical maximum. With passive balancing, a switchable external shunt resistor across each cell is used to discharge cells and limit the voltage of individual cells already at maximum voltage to allow further charging of the battery pack and raising all the cells to their maximum state of charge. The battery stack is charged to its true maximum potential with passive balancing.

Each of the 16 battery channels on the evaluation module incorporates an external N-channel MOSFET in series with a shunt 75- Ω , 1-W resistor across the battery cell. A secondary load is also incorporated in the form of an LED which lights when the MOSFET is on and balancing is active. The 16 N-channel MOSFETs are controlled by 16 EQ lines from the bq76PL455A-Q1 allowing independent balancing of each battery as determined from the cell voltage measurements.

To balance an individual cell, the EQ line for the N-Channel MOSFET on the selected channel is driven high. Once it is turned on, current flows through the shunt resistor and LED circuit to dissipate excess charge. The standard bq76PL455EVM is supplied with 16 x 75- Ω , 1-W (at 25C° ambient) shunt resistors which give a 56-mA balancing current for a cell at 4.2 V. Make the shunt resistor values smaller or larger to suit the application requirements. Minimum resistor value and maximum balancing current are limited only by the 1 W (at 25C°) power rating of the individual 2512 size balancing resistors and resulting PCB temperature when all 16 balancing resistors are on.

4.5 Embedded Control Logic

The bq76PL455A-Q1 incorporates control logic to manage serial communications with the PC or main system controller to control the monitoring and balancing functions and to respond back to the PC or main system controller with the requested data.

The bq76PL455A-Q1 embedded control logic uses both EEPROM and RAM to store control register-based configuration data. EEPROM maintains configuration data while the bq76PL455A-Q1 is in power down mode. The configuration data is transferred from EEPROM to RAM when the bq76PL455A-Q1 wakes; RAM data are used during normal operation. Modify the RAM data with a main system controller or PC GUI.

New register settings written into RAM by the system controller or PC GUI can be transferred to EEPROM on the bq76PL455A-Q1 IC if required to be automatically loaded on the next power cycle. In a typical, real-world implementation, the EEPROM is not required to be written frequently, therefore, the bq76PL455A-Q1 EEPROM is designed with limited endurance write cycles unsuited to the evaluation module environment.

Consequently, writing RAM register values to EEPROM is enabled but generates a warning message on the evaluation module. The GUI allows the user to store their own register configurations on the PC as .reg files as an alternative to programming the EEPROM. These configuration files can then be restored manually as desired, such as after a power cycle. Alternatively, new configurations for the bq76PL455A-Q1 are written to RAM directly after any new power cycle using the controls in the GUI.

4.6 Communications

Communication between the PC GUI and the first bq76PL455EVM is done via a USB-to-TTL Serial converter cable. This cable connects to the J3 - Serial connector on the bq76PL455EVM. Communication between all subsequent stacked bq76PL455EVMs is done over isolated, differential twisted pair, daisy chained communication lines connected between the J4 - Diff Comm Low and J5 - Diff Comm High connectors of neighboring bq76PL455EVMs. The communication rate between the PC and the first of potentially multiple stacked modules is adjustable to various baud rates from 125K to 1M, whereas the communication rate over the daisy chain link is fixed. The typical minimum bit period over the daisy chain link is 125 ns (8 MHz). Communication over the differential daisy chain link is transparent to the user via the GUI, as the conversion between the single-ended communications link and the differential communications link is handled in hardware by the bq76PL455A-Q1.

Communication is mastered by the PC GUI using a command and response protocol which allows the GUI to configure and read back data from slave bq76PL455EVMs. Under the command and response protocol, communication with the bq76PL455EVM(s) is always initiated by the GUI which issues a command frame. Command frames are addressed to either an individual bq76PL455A-Q1, sent as a broadcast to a pre-specified group of consecutively addressed bq76PL455A-Q1 devices, or sent as a general broadcast to all bq76PL455A-Q1 devices on the J4 - Diff Comm Low and J5 - Diff Comm High bus. Some command types are currently supported by the GUI only in the *Extended Window* interface.

The following six types of command frames are supported by the bq76PL455A-Q1:

1. Write to a single bq76PL455A-Q1 causing a returned response (that is, essentially a “read” command).
2. Write to a single bq76PL455A-Q1 with no response.
3. Write to a pre-defined group of bq76PL455A-Q1 devices to generate a series of responses (device with highest address in group responds first).
4. Write to a pre-defined group of bq76PL455A-Q1 devices without a response request.
5. Write to all connected bq76PL455A-Q1 devices to generate a series of responses (device with the highest address responds first).
6. Write to all connected bq76PL455A-Q1 devices with no responses generated.

The GUI currently uses command types 1, 2 and 6 from the aforementioned list during its operation as part of the graphical interface. The remaining command frame types are accessible only through the extended window manual command interface and scripting options.

On the bq76PL455EVM, high-voltage isolation is provided on all of the twisted pair differential communication links between each stacked evaluation module.

The serial bus allows Command frames to be transmitted by the PC and to be received by all bq76PL455EVMs. Response frames, when requested, are transmitted by any addressed bq76PL455EVM back to the PC.

Since response frames are only ever sent in response to command frames, a single physical pair of wires is used to communicate between any two neighboring bq76PL455A-Q1 devices in a half duplex manner to alternately send and receive data. The physical differential pair connections are implemented using capacitive-coupling and are designed to meet the needs of wired differential communications in automotive applications.

For battery systems with more than 16 cells where multiple bq76PL455EVMs are stacked, each evaluation module must have a unique address. Although the bq76PL455A-Q1 IC allows addresses to be set either with the GPIO lines in hardware or via software, the evaluation module and GUI are, by default, auto-addressed by the GUI when the GUI starts. If more than one evaluation module is connected, bq76PL455EVMs are auto-addressed with addresses from 0 to $n - 1$, where n is the number of modules connected. The bq76PL455EVM connected to the PC is address 0, the first daisy-chained evaluation module is at address 1, the second daisy-chained evaluation module is at address 2, and so on.

When polling and balancing, the GUI can communicate with multiple bq76PL455EVMs in a stacked configuration and log the data received from these evaluation modules to log files stored on the PC, but the GUI allows data from only a single bq76PL455EVM to be viewed in real time. To switch the real time view to another bq76PL455EVM, polling and balancing must be stopped, and the user must select a new evaluation module address from the *Board Address* pull-down menu on the *Setup* tab, then re-enable polling or balancing.

4.7 Fault

When a fault condition is detected, the bq76PL455A-Q1 communicates the fault back to the host PC on the FAULT pin. Faults from evaluation modules higher in the daisy chain stack are communicated to the bottom (that is, lowest address) evaluation module using the FAULT \pm differential signal pairs on the J5 - Diff Comm High and J4 - Diff Comm Low connectors. In the case of the bottom bq76PL455A-Q1, the single-ended active low $\overline{\text{FAULT}}$ signal is driven low whenever a fault is detected. Since a single virtual $\overline{\text{FAULT}}$ line is shared by all bq76PL455A-Q1 devices, in a user application the $\overline{\text{FAULT}}$ line going low should trigger the system controller to start sending commands to discover which bq76PL455A-Q1 detected the fault and understand the nature of that fault so it can take appropriate action.

Currently, the daisy-chained $\overline{\text{FAULT}}$ signal terminates at the lowest evaluation module and the line status is measured at pin 2 of the J3 - Serial connector. Additionally, a Flt-N test pin is also provided. The GUI automatically polls the fault registers of the bq76PL455A-Q1 to show current status of all unmasked faults.

4.8 Wake and Power Down

The bq76PL455A-Q1 has two power states, On (powered up) and Off (powered down). The power state is controlled by a hardware wake signal and a “wake up tone” on the differential twisted pair communications link between multiple evaluation modules. In single-ended mode, the bq76PL455A-Q1 uses the WAKEUP signal (pin 49) as the wake input. When this pin on the bq76PL455A-Q1 is driven high (using an inverted signal on the J3 - Serial connector), the bottom module in a daisy chain configuration powers on and generates a “wake up tone”. This tone is sent to other modules via the differential communication bus. This in turn causes all modules connected to the differential bus to also power on. To power down, the POWER_DOWN bit in the Device Control Register (address 11) is set by sending a Broadcast Command to the all bq76PL455A-Q1 devices on the stack while the WAKEUP pin is low on the bottom module.

4.9 Power Supplies

The bq76PL455EVM is powered from the top of the cell stack being monitored and balanced, which may range from 16 V–79.2 V. Although several options exist to post-regulate this high voltage supply down the bq76PL455A-Q1’s integrated linear voltage regulator, the bq76PL455EVM implements a simple drop-down voltage divider. This provides the best low noise performance at the expense of higher bq76PL455EVM current compared to an implementation in which a switching buck converter is used. A switching buck converter optimizes efficiency, but compromises noise performance.

The bq76PL455A-Q1 linear voltage controller uses an external NPN power transistor to regulate a 5.3-V output supply at VP1. The VP1 supply then drives the VDIG digital supply on the bq76PL455A-Q1. A separate external VIO supply line into the bq76PL455A-Q1 is provided by the PC host via pin 3 on the J3 - Serial connector. Although it is possible to externally supply the VDIG digital supply, it is not recommended to do so on the bq76PL455EVM.

The bq76PL455A-Q1 also produces a regulated 1.8-V supply for internal use and a 2.5-V reference for use by the integrated 14-bit ADC. There is no external (pin) access to the 1.8-V supply.

5 Hardware

5.1 Switches

There are 2 DIP switch packages on the bq76PL455EVM. The DIP packages provide five individual switch levers. Configure the switch levers prior to application of bq76PL455EVM power. The switch package designations are:

- *SW1 - OUT Filter Select* switch package
- *SW2 - COMM Mode Select* switch package

WARNING

Changing switch positions with power connected to the evaluation module can cause damage to the bq76PL455EVM.

The operation of the switch packages are detailed in [Section 5.1.1](#) through [Section 5.1.2](#).

5.1.1 SW1 - OUT Filter Select

This 4-position DIP switch is used to connect different capacitor values to OUT1/OUT2, the output of the AFE before it enters the 14-bit ADC for conversion. This allows different single-pole low pass filters to be used in the signal path depending on the ADC sampling configuration selected in the GUI.

NOTE: NOTE: The current version of the GUI reads and displays the sample periods from the appropriate registers in the bq76PL455A-Q1 devices with which it is communicating. By default at the time of writing, bq76PL455A-Q1 devices are configured to sample the cell channels at 60.04 μ s with 8x averaging (staying on a single channel before moving on to the next channel). For this configuration, the best external capacitor selection is 390 pF. Please be sure to change the corresponding *SW1 - OUT Filter Select* switch if the GUI sampling period configuration is changed.

Switch positions on the *SW1 - OUT Filter Select* switch package are marked with the numbers '1' through '4' on one side of the package, and marked with the word "ON" on the other side of the switch package.

To select the 390 pF recommended for the default configuration, set only switch 4 to the "ON" position.

If changing the default sampling configuration, for example to a single sample (that is, no averaging) setting at 99.92 μ s, other capacitors must be switched into the circuit.

Table 1 shows how to set switches for the various selectable sample rates. An ‘x’ means set the indicated switch(es) toward the “ON” side of the switch package. All table values are provided for a “no averaging” configuration.

Table 1. Switch Settings for Sample Rates

SW1 - OUT Filter Select	99.92 μs	60.04 μs	40.10 μs	30.02 μs	24.98 μs
Switch 1	x	x			
Switch 2	x		x	x	x
Switch 3	x		x		
Switch 4	x			x	

By setting the switch package switches as indicated above, the capacitor values associated with each sample rate are as follows:

- 99.92 μ s 4850 pF
- 60.04 μ s 2700 pF
- 40.10 μ s 1760 pF
- 30.02 μ s 1590 pF
- 24.98 μ s 1200 pF - Not recommended (see note)

NOTE: Although selectable in the current version of the GUI, selection of sample rates faster than 24.98 μ s (19.94 μ s, 17.42 μ s, 14.90 μ s, 12.60 μ s, 10.08 μ s, 8.02 μ s, 5.96 μ s, or 4.13 μ s) are not recommended at this time due to potential loss in accuracy at those sample rates. Recommended sample rates when not using averaging are 99.92 μ s, 60.04 μ s, 40.10 μ s, 30.02 μ s, and in some cases 24.98 μ s.

5.1.2 SW2 - COMM Mode Select

This switch package has a single lever to control multiple connections. The purpose of the ganged switches controlled by the switch lever is to configure the low-side interface of the bq76PL455A-Q1 between single-ended and differential modes. There are two labels, one on either side of the SW2 - *COMM Mode Select* switch: “SINGLE” and “DIFF”. When the bq76PL455EVM is connected directly to a PC, set the SW2 - *COMM Mode Select* switch so the lever is in the SINGLE mode position. On the other hand, if the bq76PL455EVM occupies the second or higher position in a stack of evaluation modules, then set the SW2 - *COMM Mode Select* switch lever to the DIFF mode position.

For Differential Mode, move the switch lever toward the DIFF label.

For Single-Ended Mode, move the switch lever toward the SINGLE label.

WARNING

Differential mode is the only allowed position when using the differential daisy-chain communication interface on stacked bq76PL455EVMs.

WARNING

Single-Ended mode is an unisolated connection for PC communication and should not be used on stacked bq76PL455EVMs occupying positions 2 or higher in the stack.

5.2 Connectors

The following connections are provided on the bq76PL455EVM:

- 22-pin J1 - Battery connector
- 4-pin differential serial communications J4 - Diff Comm Low connector (to connect to lower bq76PL455EVM in daisy chain)
- 4-pin differential serial communications J5 - Diff Comm High connector (to connect to higher bq76PL455EVM in daisy chain)
- 6-pin single-ended J3 - Serial communications connector
- 16-pin (8x2) dual row J2 - Thermistor connector
- 14-pin (7x2) P1 - GPIO header

5.2.1 J1- Battery Connector

The battery cell connections are made with a Molex connector as detailed in the table below. Cell voltage measurements and balancing currents are transmitted across these connections. Unused cell monitoring channels must be shorted to the top cell connection in the wiring harness.

The mating connector from Molex Connector Corporation is part number 50-57-9422.

Digikey Corporation: WM2920-ND.

The crimp pin for this mating connector from Molex Connector Corporation is part number 16-02-0088 or 16-02-0104.

Digikey Corporation: WM2564TR-ND or WM2564CT-ND or WM2564-ND.

The part number for the crimper to create custom cables using the above parts from Molex Connector Corporation is: 63811-8700.

Digikey Corporation: WM9017-ND.

NOTE: BAT16S and BAT0S are the monitoring and balancing connections to the top and bottom of the stack. BAT0 and BAT16 are the top and bottom of the stack connections used to power the evaluation module.

Table 2. Battery Connector Pin Assignments

Connector Pin	Pin Function
1	BAT0
2	BAT16
3	BAT0
4	BAT0S
5	BAT1
6	BAT2
7	BAT3
8	BAT4
9	BAT5
10	BAT6
11	BAT7
12	BAT8
13	BAT9
14	BAT10
15	BAT11
16	BAT12
17	BAT13
18	BAT14

Table 2. Battery Connector Pin Assignments (continued)

Connector Pin	Pin Function
19	BAT15
20	BAT16S
21	BAT16
22	BAT0

NOTE: All signals with like names are connected together on the bq76PL455A-Q1 PCB. Pins 1 and 22 of the J1 – Battery connector are identified with silkscreen markings.

5.2.2 J4 - Diff Comm Low and J5 - Diff Comm High Connectors

The 4-pin J4 - Diff Comm Low and J5 - Diff Comm High connectors house the two isolated twisted pair differential communication signal pairs used to interconnect stacked bq76PL455EVMs. The two differential pairs at pins 1 to 4 of the lower module's J5 - Diff Comm High connector always connect to the two differential pairs at pins 4 to 1 of the next higher module's J4 - Diff Comm Low connector, respectively. For each twisted pair connection, the "xxL+" signal of one bq76PL455EVM is connected to the "xxH+" signal of the neighboring bq76PL455EVM, and the "xxL-" signal of one bq76PL455EVM is connected to the "xxH-" signal of the neighboring bq76PL455EVM. The two twisted pair signals are ISO-COMM± and ISO-FAULT±.

The tables below identify the pin assignments on the J4 - Diff Comm Low and J5 - Diff Comm High connectors. Pins 1 and 4 are marked on the silkscreen associated with the J4 - Diff Comm Low and J5 - Diff Comm High connectors on the bq76PL455EVM. Additionally, on both the J4 - Diff Comm Low and the J5 - Diff Comm High connector, pin 1 has a square pad on the bottom of the bq76PL455EVM.

Table 3. J4 - Diff Comm Low Connector Pin Assignments

Pin Number	Pin Function
1	ISO COMML-
2	ISO COMML+
3	ISO FAULTL-
4	ISO FAULTL+

Table 4. J5 - Diff Comm High Connector Pin Assignments

Pin Number	Pin Function
1	ISO FAULTH+
2	ISO FAULTH-
3	ISO COMMH+
4	ISO COMMH-

NOTE: All signals ending in "H+" or "H-" connect with the next higher module, and all signals ending in "L+" or "L-" connect with the next lower module. In the event of no "next module", leave the pins unconnected.

The mating connector from Molex Connector Corporation is part number 50-57-9404.

Digikey Corporation: WM2902-ND.

The crimp pin for this mating connector from Molex Connector Corporation is part number 16-02-0088 or 16-02-0104.

Digikey Corporation: WM2564TR-ND or WM2564CT-ND or WM2564-ND.

The part number for the crimper to create custom cables using the above parts from Molex Connector Corporation is: 63811-8700.

Digikey Corporation: WM9017-ND.

5.2.3 J3 - Serial Connector

The 6-pin J3 - Serial connector is used to connect the bq76PL455EVM to a PC running the GUI. Signals at the J3 - Serial connector are 5-V TTL signals. TI recommends the use of FTDI's USB-to-TTL Serial converter cable to allow connection with a PC's USB port. The recommended cable is available from FTDI (<http://www.ftdichip.com>), and the appropriate part number for the 1.8 meter cable is TTL-232R-5V.

Table 5 provides the J3 - Serial connector pin assignment.

NOTE: The $\overline{\text{WAKE}}$ signal from the PC is inverted on the bq76PL455EVM before being directed to the bq76PL455A-Q1.

Table 5. J3 - Serial Connector Pin Assignments

Pin Number	Pin Function	Mating Cable Color
1	Ground	Black
2	$\overline{\text{FAULT}}$ signal from bq76PL455A-Q1	Brown
3	5-V input from PC	Red
4	RX from PC to bq76PL455A-Q1	Orange
5	TX from bq76PL455A-Q1 to PC	Yellow
6	$\overline{\text{WAKE}}$ signal from PC	Green

5.2.4 J2 - Thermistor Connector

There is provision for connecting up to eight thermistor signals via a 16-pin, 8x2 right angle connector to the bq76PL455EVM. The bq76PL455EVM provides a 10-k Ω pull-up resistor to VP1, the on-board 5.3-V regulated supply, for each AUX input channel. Each connector pin also has a 10- Ω series resistor and a 0.1- μF filter capacitor.

The J2 - Thermistor connector pin assignment is detailed in Table 6.

Table 6. J2 -Thermistor Connector Pin Assignments

Pin Number	Pin Function
1	Ground (AGND1)
2	Ground (AGND1)
3	Ground (AGND1)
4	Ground (AGND1)
5	Ground (AGND1)
6	Ground (AGND1)
7	Ground (AGND1)
8	Ground (AGND1)
9	AUX0 (Thermistor 1)
10	AUX1 (Thermistor 2)
11	AUX2 (Thermistor 3)
12	AUX3 (Thermistor 4)
13	AUX4 (Thermistor 5)
14	AUX5 (Thermistor 6)

Table 6. J2 -Thermistor Connector Pin Assignments (continued)

Pin Number	Pin Function
15	AUX6 (Thermistor 7)
16	AUX7 (Thermistor 8)

NOTE: Pins number assignments on the J2 - Thermistor connector are such that, when looking into the mouth of the connector, the bottom of row of the connector is numbered 1–8 from right to left, and the top row of the connector is numbered from 9–16 from right to left. Pin 1 on the connector has a square pad on the bottom of the PCB. Additionally, pins 1, 8, 9, and 16 are labeled with silk-screened numbers.

The mating connector from Molex Connector Corporation is part number 43025-1600.

Digikey Corporation: WM2490-ND.

The crimp pin for this mating connector from Molex Connector Corporation is part number 46235-5001 (or 46235-5002).

Digikey Corporation: WM2258TR-ND or WM2258CT-ND. (An alternate base number for different plating option is WM2259.)

The part number for the crimper to create custom cables using the above parts from Molex Connector Corporation is: 63819-2900.

Digikey Corporation: WM4747-ND.

5.2.5 P1 - GPIO Header

The bq76PL455A-Q1 implements six General Purpose Input/Output (GPIO) signals. The bq76PL455EVM provides access to these GPIO pins (in addition to the VIO supply and DGND) at the 14-pin 7x2 unshrouded P1 - GPIO header. Configure the GPIO pins as input or output by writing to specific configuration registers in the bq76PL455A-Q1. Additionally, program configuration registers to choose internal pull-up or pull-down resistors for any of the GPIO pins. Digital input signals are read by reading the General Purpose Input register, and digital output values are set by writing to the General Purpose Output register in the bq76PL455A-Q1. These registers can be written and read using the *Register View* window from the GUI (see [Section 7.2](#)). The bq76PL455A-Q1 data sheet ([SLUSC51](#)) provides additional details.

When configured as inputs, the GPI can also be selectively programmed to generate fault signals when changing state either from digital high to low or from digital low to high. This configuration is done on the *Fault Mask* tab in the GUI, and triggered faults are viewed on the *Faults* tab.

[Table 7](#) shows pin assignments for the P1 - GPIO header.

Table 7. P1 - GPIO Header Pin Assignments

Pin Number	Pin Function
1	GPIO0
2	Ground (DGND)
3	GPIO1
4	Ground (DGND)
5	GPIO2
6	Ground (DGND)
7	GPIO3
8	Ground (DGND)
9	GPIO4
10	Ground (DGND)

Table 7. P1 - GPIO Header Pin Assignments (continued)

Pin Number	Pin Function
11	GPIO5
12	Ground (DGND)
13	VIO
14	Ground (DGND)

NOTE: The P1 - GPIO header is a 7x2 dual row unshrouded header. Pin 1 has a square pad on the underside of the PCB, and the silk screen for the header indicates pin 1 with a small white dot. All even numbered pins are on one, and all odd numbered pins are on the other, row of the header.

5.3 Test Points

Table 8 contains a list of test points provided on the evaluation module.

Table 8. bq76PL455EVM Test Points

Name	Description
BAT16	Positive terminal of cell 16
BAT0	Negative terminal of cell 1
S0-S16	Connected to Vsense0-16 on bq76PL455A-Q1
TOP	Connected to TOP pin of bq76PL455A-Q1 – primary power supply to bq76PL455A-Q1
VP1	Regulated 5.3-V supply
VDIG	Digital 5.3-V supply (connected to VP1)
V5VAO	5.3-V output from bq76PL455A-Q1
AGND1	Local analog ground
AGND2	Quiet analog ground
OUT	AFE analog output from bq76PL455A-Q1
VREF	2.500 V precision reference output from bq76PL455A-Q1
VIO	I/O supply (connected to VIO pin on the bq76PL455A-Q1)
DGND	Local digital ground
VM	–5-V charge pump output from bq76PL455A-Q1
CHP	Charge pump flying capacitor connection
V1.8	1.8-V output from bq76PL455A-Q1 (provided for compatibility with early devices only)
WAKEUP	The single-ended, active high wake pin to the bq76PL455A-Q1
FLT-N	The single-ended, active low fault pin from the bq76PL455A-Q1 (to the PC)
RX	The single-ended serial data receive pin on the bq76PL455A-Q1 (data from PC)
TX	The single-ended serial data transmit pin on the bq76PL455A-Q1 (data to the PC)
COMMH+	Half of the differential pair communicating data to and from the lower of two neighboring bq76PL455EVMs to the next higher bq76PL455EVM
COMMH–	Half of the differential pair communicating data to and from the lower of two neighboring bq76PL455EVMs to the next higher bq76PL455EVM
COMML+	Half of the differential pair communicating data to and from the higher of two neighboring bq76PL455EVMs to the next lower bq76PL455EVM
COMML–	Half of the differential pair communicating data to and from the higher of two neighboring bq76PL455EVMs to the next lower bq76PL455EVM
FAULTH+	Half of the differential pair receiving fault information from the next higher bq76PL455EVM
FAULTH–	Half of the differential pair receiving fault information from the next higher bq76PL455EVM
FAULTL+	Half of the differential pair transmitting fault information to the next lower bq76PL455EVM
FAULTL–	Half of the differential pair transmitting fault information to the next lower bq76PL455EVM

6 Getting Started with the bq76PL455EVM

The following sequence is recommended to use the bq76PL455A-Q1 evaluation module:

1. Install the GUI on the PC.
2. Configure the bq76PL455EVM DIP switches.
3. Connect the bq76PL455EVM to the battery stack and PC.
4. Start the GUI and configure the bq76PL455A-Q1 control registers.
5. Start polling, balancing and monitoring status.
6. Stop polling, stop balancing.
7. Exit the GUI.

These steps are detailed in subsequent sections of this document.

6.1 Software Drivers

An FTDI FT232R USB-to-UART adapter driver is required to connect to the passive balancing evaluation module to a PC. The driver is either installed automatically as part of the cable install when installing the TTL-232R-5V from FTDI, or download it from www.ftdichip.com/Drivers/VCP.htm.

6.2 GUI

Included with the TI passive balancing evaluation module is a PC GUI. The GUI is used to configure the evaluation module, read out and log all cell voltage data, control balancing, and manage faults.

The primary parameters configurable in the GUI are as follows:

- Number of batteries/series cells in each module
- Overvoltage and undervoltage threshold limits
- Balancing period
- Fault conditions
- Communication and parameters

6.3 Recommended PC Requirements

The requirements for the PC are listed below:

- Microsoft® Windows® XP system and above
- Intel® Core™2 Duo processor with vPro™ technology at 2 GHz
- 1 GB RAM
- 1024 x 768 display
- 4MB hard drive space
- USB 2.0 port

6.4 Installation Instructions

Extract all files and folders in the provided .zip file. This creates a sub-folder on your system containing two files:

- bq76PL455_GUI_Installer.msi
- setup.exe

Double clicking *setup.exe* initiates the bq76PL455_GUI Setup Wizard. Selecting the *Next* button, shown in [Figure 3](#), starts the installation process.

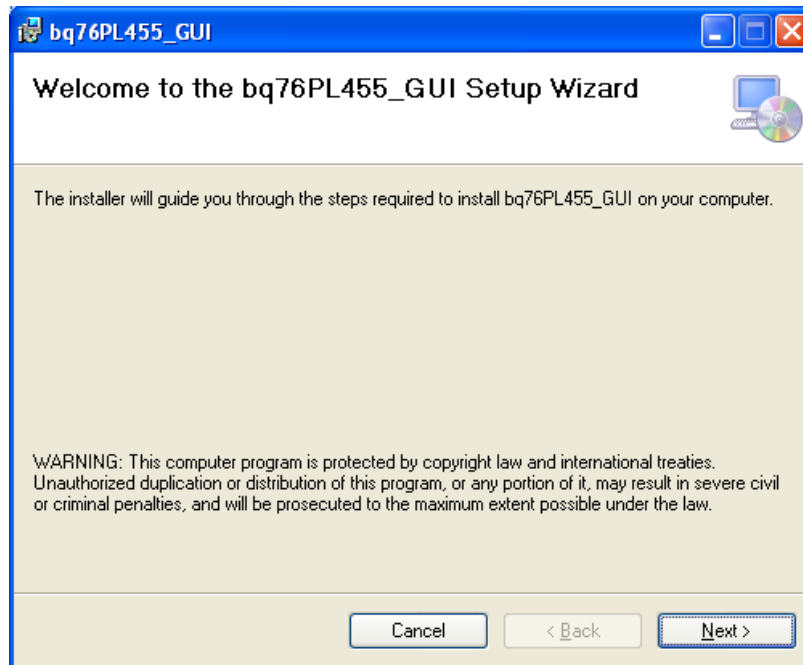

Figure 3. Install Wizard

A Software License Agreement is required as part of the installation process (Figure 4).

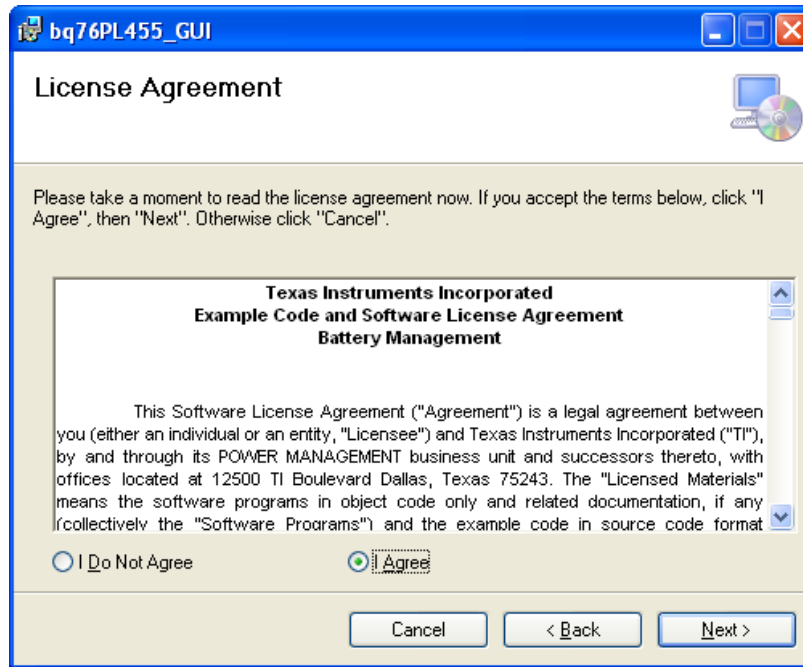

Figure 4. Software License Agreement Acceptance

An option to install the bq76PL455_GUI to any desired directory is available. Unless there is some specific reason not to use the default, it is recommended to keep the default settings for installation. This can make trouble-shooting any potential installation problems easier. The default settings for installation are shown in Figure 5.

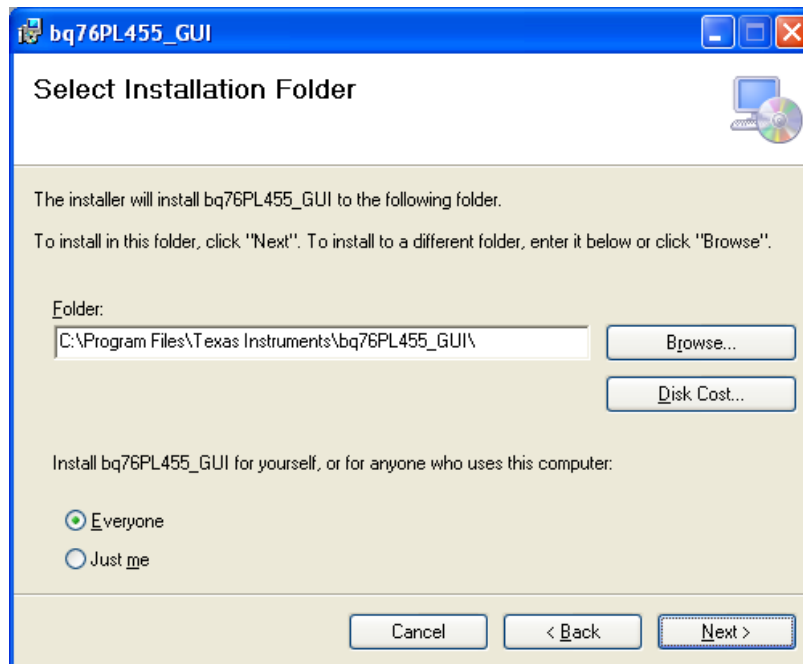

Figure 5. GUI Install Location Selection

After the installation directory for the GUI is selected, you are asked to confirm the installation (Figure 6). Confirming the installation starts the installation process. The GUI uses .NET Framework files. If the required files are not already loaded on the computer to which the GUI is installed, the installer automatically tries to download the required files in order to complete the software installation. For this reason, it is recommended that an Internet connection be available if the .NET Framework files are not already available on the install computer.

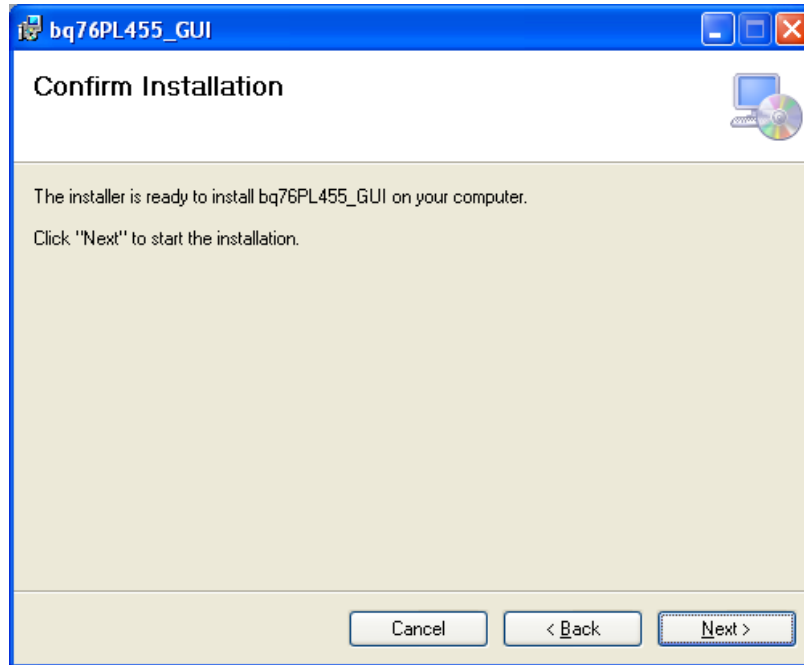

Figure 6. GUI Installation Confirmation

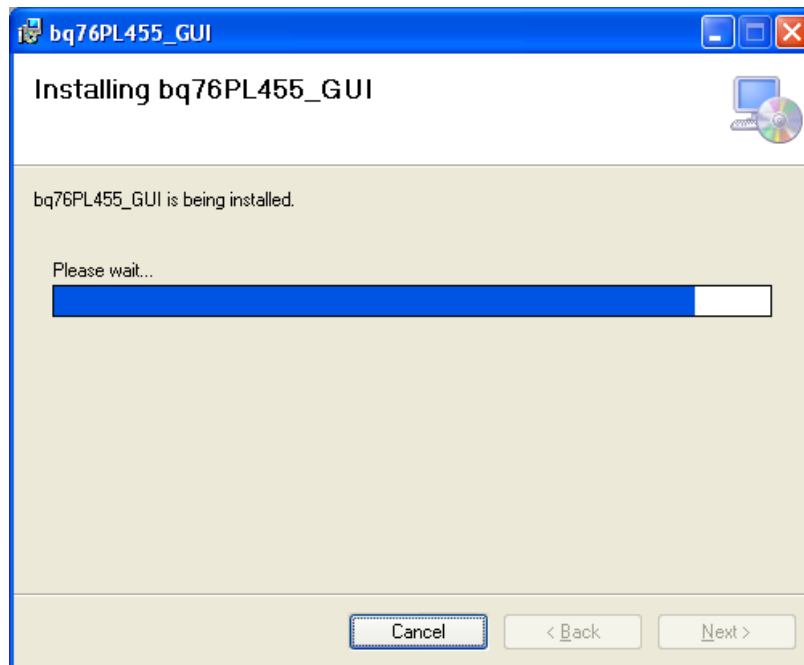

Figure 7. GUI Installation Progress

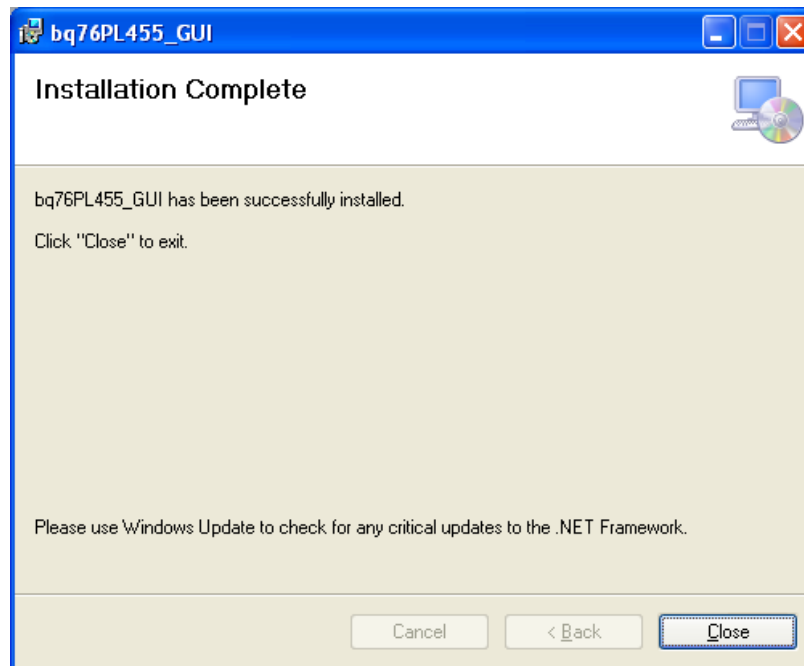

Figure 8. GUI Installation Completion

A window appears when the bq76PL455_GUI installation is complete ([Figure 8](#)). Clicking the *Close* button in this window exits the bq76PL455 GUI Installer. A shortcut called bq76PL455_GUI is placed on the desktop. Additionally, the GUI and an Uninstall Utility are accessible from the Windows Start Menu under:

- Start → Programs → Texas Instruments → bq76PL455A-Q1_GUI → bq76PL455A-Q1_GUI.exe

NOTE: If upgrading from a previous version of GUI, uninstall the previous version prior to installation of the new version. This is done easily by selecting the Uninstall utility from the bq76PL455A-Q1 GUI Start Menu (Start → Programs → Texas Instruments → bq76PL455A-Q1_GUI).

6.5 Configuring a Single bq76PL455EVM

Run the setup.exe file included with the passive balancing evaluation module, making sure both of the aforementioned files are in the same directory. You should see the bq76PL455_GUI Setup Wizard screen of the install utility.

[Figure 9](#) shows an example of a single bq76PL455EVM configuration.

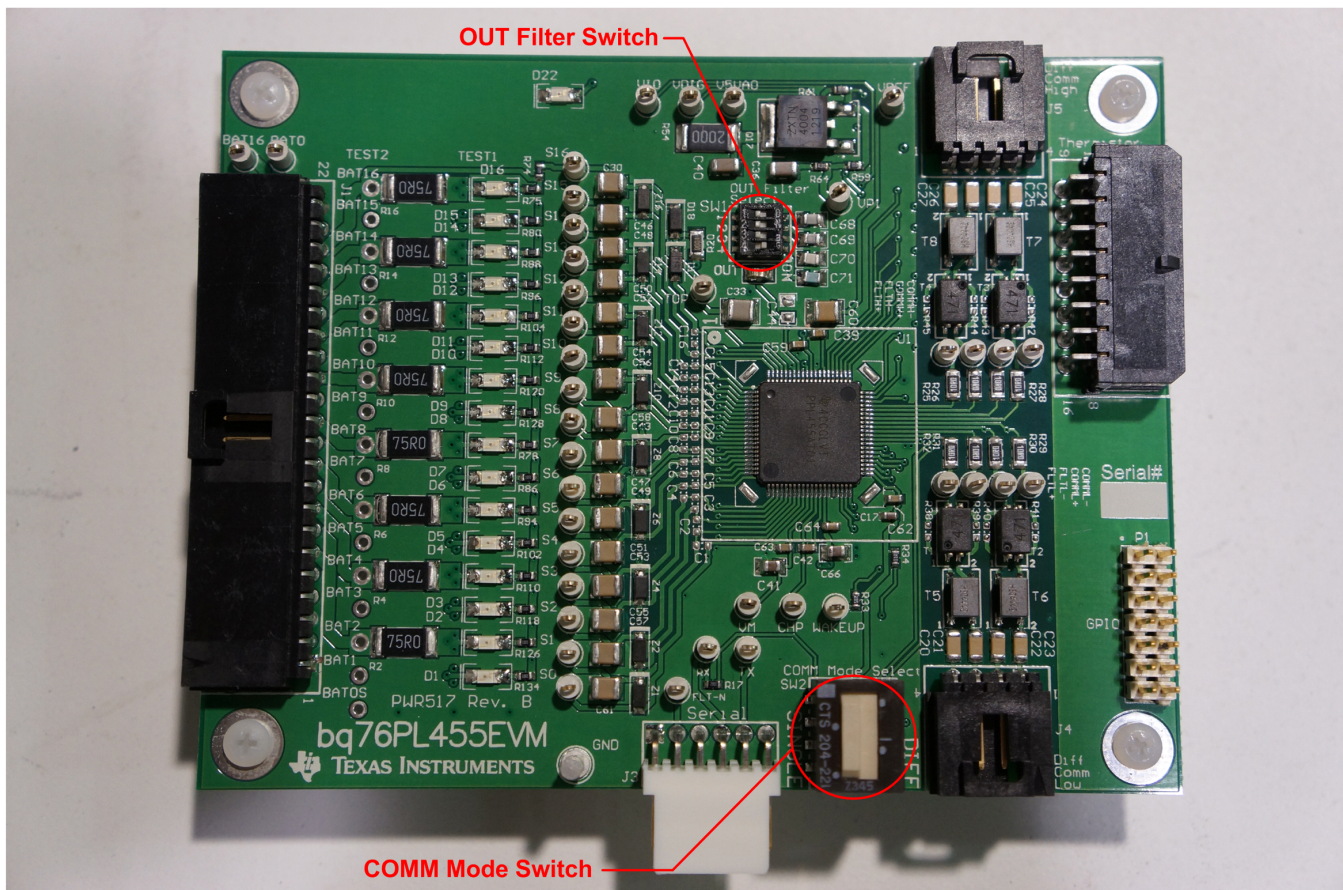

Figure 9. Single bq76PL455EVM Switch Configuration

Set the switches to the default positions, or as follows:

1. The configuration for a sample period setting of 60.04 μs with 2.7 nF by setting switch 1 on the OUT FILTER switch package to "ON" is shown in [Figure 9](#).
2. Select single-ended serial communication by setting the SW2 - COMM Mode Select switch toward the SINGLE silk screen label.
3. Connect the FTDI TTL-232R-5-V USB-to-Serial cable to the J3 - Serial connector and the USB port on the PC.

NOTE: For additional isolation safety, use a USB isolator between the PC's USB port and the FTDI cable. The KX USB-150 full-speed USB isolator has been tested by TI and it is available from Keterex (see www.keterex.com for more details).

6.6 Connecting and Powering the bq76PL455EVM

Connect the bq76PL455A-Q1 evaluation module J1 - Battery connector to the battery stack or power supply and apply power. Alternatively, a user-supplied load board (that is, resistive ladder board) and power supply may be used to simulate cell connections.

NOTE: Although it is not strictly required due to the presence of on-module protection circuitry, when using a battery stack, it is recommended to first apply power from the top and bottom of the stack to BAT16 and BAT0, respectively, in order to power the bq76PL455EVM, before applying power from the intermediate stack cell connections to BAT0S, BAT1, BAT2 through to BAT15, and BAT16S. This is achieved using a make-first, break-last type battery connector if hot plugging or using switches to sequence power application.

Start the GUI. This step is explained in greater detail in the [Section 7](#) of this document.

6.7 Configuring Stacked bq76PL455EVMS

Instructions for configuring stacked bq76PL455EVMS are as follows:

1. Identify the bq76PL455EVM that is connected to the bottom 16-cell module and the bq76PL455EVMS that is stacked above it - connected to the higher 16-cell modules within the battery system. On the bottom bq76PL455EVM that is connected to the PC, connect the bottom end of the twisted pair daisy chain cable to the J5 - Diff Comm High connector. Then, connect the other end of this twisted pair daisy chain cable to the J4 - Diff Comm Low connector on the second bq76PL455EVM. Continue with this pattern for all subsequent bq76PL455EVMS in the daisy chain stack.
2. On the bottom bq76PL455EVM that is connected to the PC, set the SW2 - *COMM Mode Select* switch as shown in [Figure 9](#). On all other stacked bq76PL455EVMS, set the lever on the SW2 - *COMM Mode Select* switch package in the opposite direction, toward the DIFF label
3. Set SW1 - *OUT Filter Select* switches on all bq76PL455EVMS to the desired setting as outlined in [Section 5.1.1](#) or as shown in [Figure 9](#).
4. Connect any desired temperature sensors to the J2 - Thermistor connector on any of the bq76PL455EVMS in the system.
5. Connect the lowest bq76PL455EVM J3 - Serial header to a PC USB port using an FTDI USB-to-TTL Serial (5 V) cable.

6.8 Connecting and Powering Stacked bq76PL455EVMS

Power a stack of bq76PL455EVMS, as configured in the previous section, with the following steps:

1. Connect the bottom evaluation module J1 - Battery connector to the lowest 16 cells of the battery stack and apply power.

NOTE: When using a battery stack, it is recommended - although not strictly required - to first apply power from the top and bottom of the stack to BAT16 and BAT0 respectively in order to power the bq76PL455EVM, before applying power from the intermediate stack cell connections to BAT0S, BAT1, BAT2 through to BAT15 and BAT16S. This is achieved using a make-first, break-last type battery connector if hot plugging or using switches to sequence power application.

2. Connect the next higher stacked evaluation module to the next higher set of 16 cells, for example, cells 17–32, using the same relative powering sequence described in step 1. Then, connect bq76PL455EVM 3 to cells 33–48, and so on.
3. Start the GUI (as described in [Section 7.1](#)).

7 Software

7.1 Using the Software

Start the GUI by double-clicking the *bq76PL455_GUI* shortcut on the PC desktop. A prompt is presented to select the COM port number for the Serial-to-USB connection, as shown in [Figure 10](#) and [Figure 11](#). In most cases, the highlighted COM port is the appropriate COM port. If this is not the case, due to a custom installation, determine the appropriate COM port by checking the Ports section in the Windows Device Manager.



Figure 10. COM Selection Window

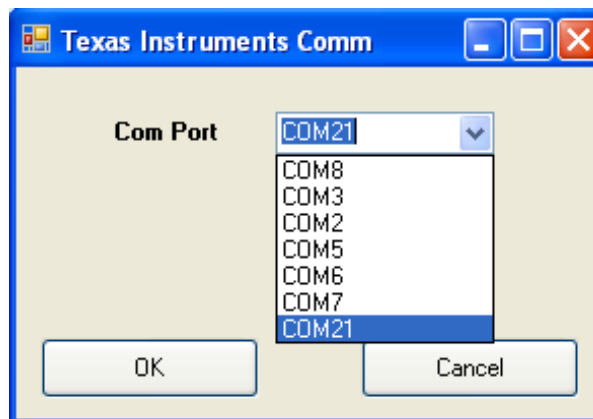

Figure 11. COM Selection Window Options

Once the correct COM port is selected, the GUI attempts to find, communicate with, and auto-address all bq76PL455EVMS connected to the selected COM port. Once this process is complete, a prompt to acknowledge the number of bq76PL455EVMS is displayed. An example of this pop-up window for a system in which four bq76PL455EVMS are connected to the PC is seen in [Figure 12](#).

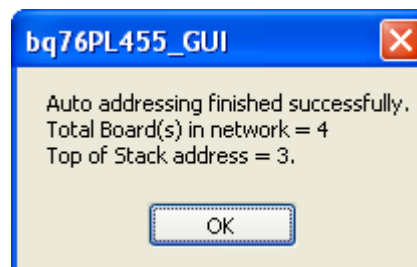

Figure 12. Auto-Addressing

Once the number of bq76PL455EVMS found is acknowledged, the GUI comes up in its default state with the *Setup* tab displayed, as seen in [Figure 13](#). No polling data is read from the passive balancing module until commands are sent to initialize and begin measurements. The default display shows the settings for Board 0, the lowest bq76PL455EVM in the stack. The board address is seen (and selected) using the *Board Address* pull-down menu near the top center of the *Setup* tab screen.

If the GUI does not appear as depicted in [Figure 13](#), it may be necessary to adjust the Display Settings on the PC running the GUI. The GUI is optimized for use with the "Smaller" font size setting. This setting is accessed from Control Panel → Display → Smaller (100%) and is typically the default system setting.

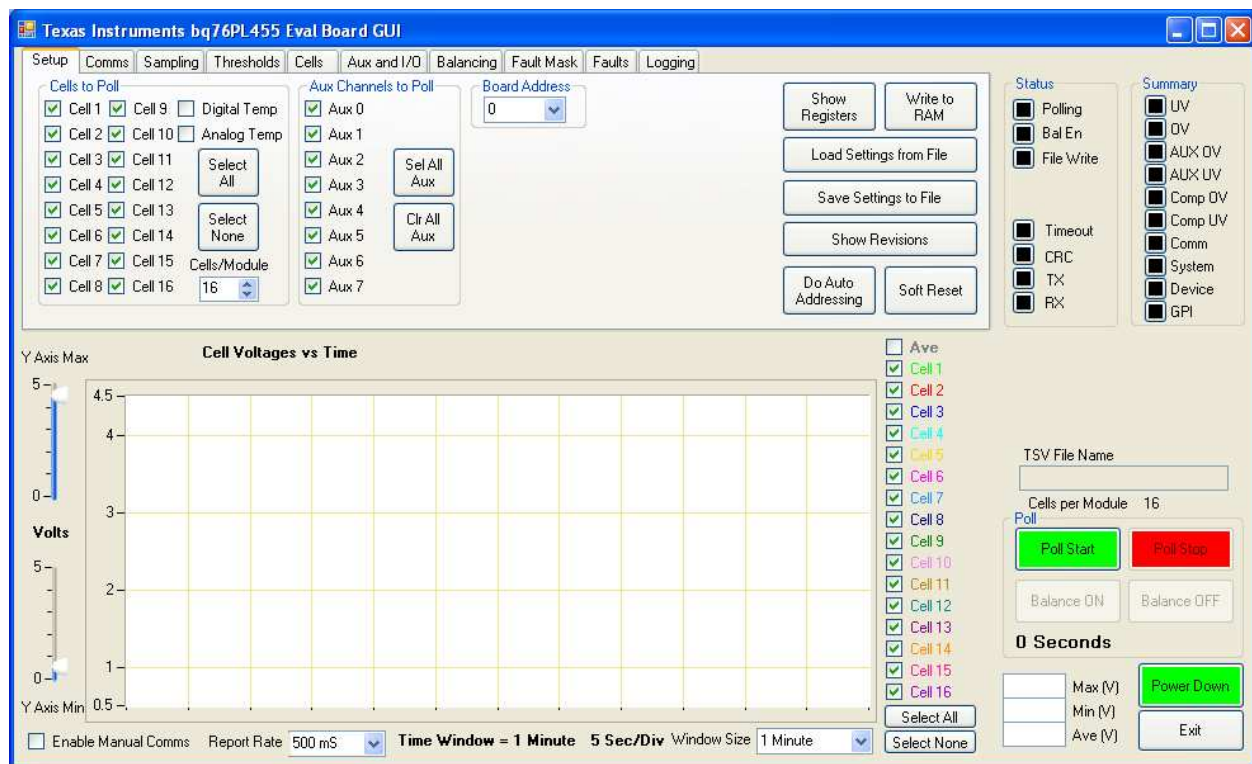

Figure 13. Initial View/Setup Tab

Clicking across the different GUI tabs, including *Setup*, *Comms*, *Sampling*, *Thresholds*, *Cells*, *Aux and I/O*, *Balancing*, *Fault Mask*, *Faults*, and *Logging* at the top of the display window produces different information displays related to these headings. The *Cell Voltages vs Time* graph, the *Status* and *Summary* indicator groups, the *Poll Start*, *Poll Stop*, *Balance ON*, *Balance OFF*, *Power Down*, and *Exit* buttons, and the TSV File Name box (that is, the logging file name box) are common to all tabs.

Set the *Cell Voltages vs Time* display from one minute to 12 hours and change the graph's voltage scale using the sliders to the left of the graph. On the right side of the graph, the choice to display individual cell data, all cell data, or none of the cell data is presented. Additionally, an average of all selected cell data can be displayed. The selections made with the selection boxes to the right of the graph do not affect the channels which are sampled by the AFE in the bq76PL455A-Q1, they only affect the channels which are displayed on the graph.

The *Status* indicators show the status of:

- Polling: Indicates when the bq76PL455A-Q1 is actively polling selected cell channels
- Bal En: Indicates when bq76PL455A-Q1 is actively balancing selected channels
- File Write: Indicates when the GUI is logging data to a file
- Timeout: Indicates the GUI timed out trying to communicate with a bq76PL455EVM
- CRC: Indicates a communications CRC error between the GUI and an EVM
- TX: Indicates the GUI is transmitting to evaluation bq76PL455EVM(s)
- RX: Indicates the GUI is receiving data from an evaluation bq76PL455EVM(s)

NOTE: The indicators for *Polling*, *Balancing (Bal En)*, and *File Write* turn green when the indicated activity is active. The *Polling* indicator has two states: on (green) and off (black). The *File Write* indicator, however, has three states: green (writing to file, polling active), red (not writing to file, polling active), and black(off) (not writing to file, polling not active). The *Balancing (Bal En)* indicator also has three states: green (balancing on, no fault detected), red (balancing was requested but a fault prevented balancing) and black (off). If timed balancing was requested, then the *Balancing (Bal En)* indicator is red once the timed period expires to indicate that the timing system is armed for the next timed period.

The *Timeout* and *CRC* fault indicators indicate a fault has occurred by turning red. These indicators must be cleared manually, once tripped, because they latch the indicated fault.

The *TX* and *RX* indicators blink green whenever the indicated activity is active.

The *Summary* indicators indicate faults, including:

- UV: Indicates a cell voltage exceeds the undervoltage threshold
- OV: Indicates a cell voltage exceeds the overvoltage threshold
- AUX OV: Indicates an AUX input overvoltage threshold is exceeded
- AUX UV: Indicates an AUX input undervoltage threshold is exceeded
- Comp OV: Indicates a comparator overvoltage threshold is exceeded
- Comp UV: Indicates a comparator undervoltage threshold is exceeded
- Comm: Indicates a communication fault has occurred
- System: Indicates a general system fault is tripped (see the data sheet for a list)
- Device: Indicates a fault in the Device Fault register is tripped (see the data sheet)
- GPI: Indicates a user-configured input fault condition has been triggered (on the GPI pin)

Clicking any fault indicator clears all faults of the same type. For instance, clicking the *UV* fault button clears all *UV* faults for all cells. Clear individual cell *UV* faults by going to the *Faults* tab, *Cell Faults*, *UV* section and clicking on the desired cell undervoltage fault indicator. Any of the *Summary Faults* can be cleared while polling is active. If the source of the fault persists, then the fault indicator reactivates.

The *TSV File Name* field shows the file where data is being logged and is set on the *Logging* tab.

The *Poll Start* button is used to initiate polling. Polling is stopped using the *Poll Stop* button. Before polling is started, set or verify the following parameters on the appropriate tab:

1. The number of *Cells/Module* and *Cells to Poll* on the *Setup* tab
2. The communications *Baud Rate* and the *Comm Timeout* period settings on the *Comms* tab
3. The *Initial Sample Delays*, *Sample Period*, *OverSample* rate, *Oversample Method* and *Aux Sample period* on the *Sampling* tab
4. The *Cell Voltage OV* and *UV* limits, *Comparator OV* and *UV* limits and *Aux Voltage OV* and *UV* limits on the *Thresholds* tab
5. The desired *Fault Masks* on the *Fault Masks* tab
6. Clear all faults on *Faults* tab (verifying proper clearing by issuing a *Query All* request, and clearing any latent faults)
7. Optionally, use the *Log File Path and Name* box on the *Logging* tab to set the storage location for the *Log File* (if logging is desired)

The *Balance ON* button is used to start balancing once the channels to be balanced have been selected on the *Balancing* tab and all faults have been cleared on the *Faults* tab.

NOTE: Cell balancing is not allowed to start if any faults are active, unless those faults have been masked or the *Continue on Fault* checkbox in the *Balance Continue* box on the *Balancing* tab is selected. Similarly, if a fault occurs during balancing, balancing stops unless the fault has been masked. Most, but not all faults can be masked on the *Fault Mask* tab.

The *Power Down* button powers down the bq76PL455EVM(s). Once powered down, the bq76PL455EVM is powered back up by clicking the *Power Up* button, which appears in place of the *Power Down* button after the bq76PL455EVM is powered down.

7.2 Setup Tab

On the *Setup* tab, set the number of cells in the module, which cell and aux channels are monitored, whether internal chip temperatures are monitored, and the bq76PL455EVM address. The *Board Address* drop-down menu is populated with the addresses of all bq76PL455EVMs discovered during the GUI start-up.

If there was a problem with auto-addressing during GUI power up and not all connected bq76PL455EVMs were recognized, reinitiate the search process by clicking the *Do Auto Addressing* button once the connection problem has been rectified.

NOTE: Failure to select at least one channel before starting polling results in a GUI error message.

Save the bq76PL455A-Q1 RAM set up data using the *Save Settings to File* button which saves the data to a file on the PC. These data can later be restored to a bq76PL455EVM using the *Load Settings from File* button.

The *Show Registers* button produces a view, as shown in [Figure 14](#), of the user-configurable registers which the GUI is writing to control bq76PL455A-Q1 operation. In the Registers view, values are observed and changed in the registers of the bq76PL455A-Q1. These registers are described in detail in the bq76PL455A-Q1 data sheet ([SLUSC51](#)). Register values are read and written from this *Register View* window, however, values are only written to RAM and cannot be saved to EEPROM using the bq76PL455EVM GUI. If power is removed from the bq76PL455EVM(s), any changes are lost. For this purpose, any changes may be saved to and restored from a file using the *Export* and *Import* buttons. When importing from a file, values are written to all registers as part of the import process. Some additional detail regarding the control buttons on this window is provided in the Register View Window section of this document.

NOTE: Since changes are made using check boxes and radio buttons in the primary GUI window, registers shown in *Register View* can change while the *Register View* window is open. If making changes in the GUI while the *Register View* is open, click Read All upon returning to the *Register View* window.

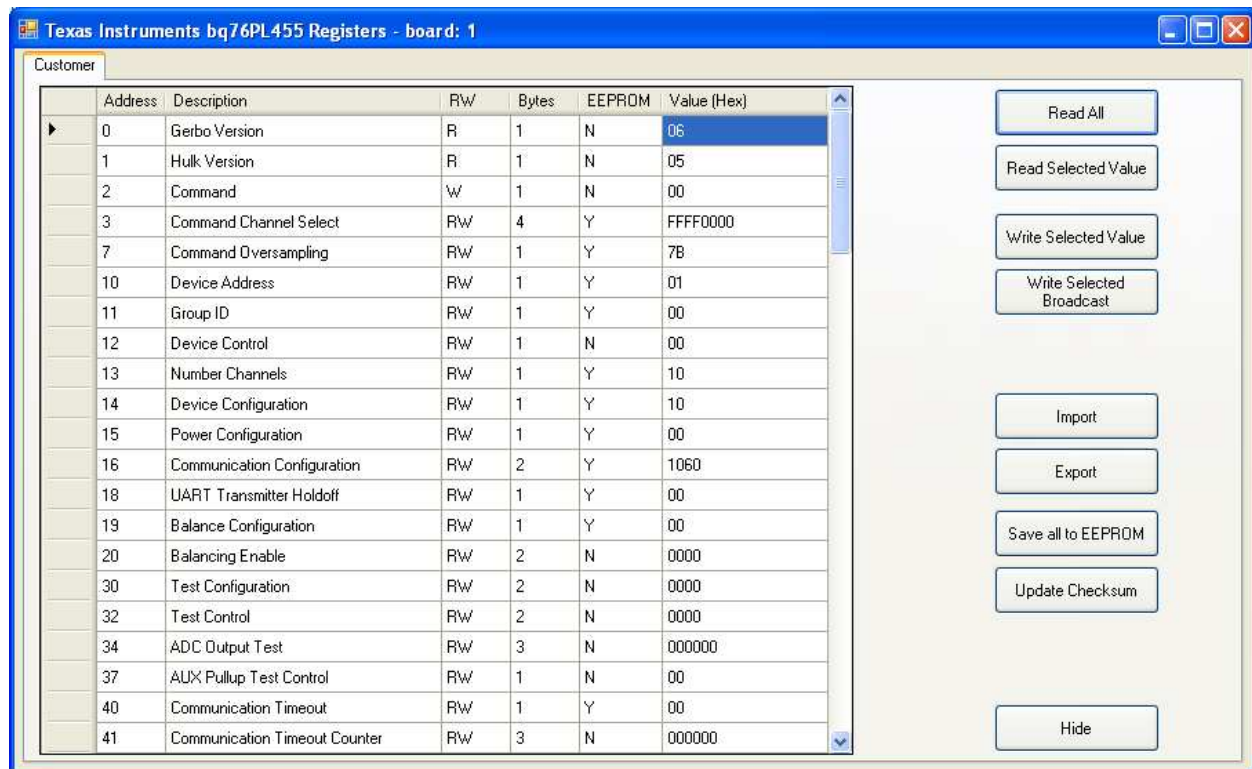

Figure 14. Register View

The *Show Revisions* button displays the current version of the GUI.

The *Write to RAM* button writes all currently selected options from all tabs to the bq76PL455A-Q1 registers in RAM. In most cases, the use of this button is superfluous, since most controls in the GUI are active controls and settings are saved immediately upon selection.

The *Soft Reset* button causes the SOFT_RESET bit in the Device Control register (register 12) to be set and initiates a reset of the digital control logic in the bq76PL455A-Q1. Please refer to the bq76PL455A-Q1 data sheet ([SLUSC51](#)) for the full description of the implications of this action. This action is not normally required or suggested, and results in the indication of *Sys Reset* and *System Faults* on the *Faults* tab (since unexpected resets are considered faults). These faults show as soon as the next request for Polling is made or the *Query All* button is clicked on the *Faults* tab.

NOTE: Failure to clear the *Sys Reset* and *System Faults* after initiating a Soft Reset will prevent the ability to enable the balancing function or the *Continue on Fault* check box on the *Balancing* tab is selected.

7.3 Register View Window

The *Register View* window contains nine buttons: *Read All*, *Read Selected Value*, *Write Selected Value*, *Write Selected Broadcast*, *Import*, *Export*, *Save all to EEPROM*, *Update Checksum*, and *Hide*.

The *Read All* button reads all registers of the bq76PL455A-Q1 on the currently selected bq76PL455EVM, and updates the register values in the Register View window. The selected bq76PL455EVM address is displayed on the window title bar of the Register View window (see [Figure 14](#)).

Verify a properly written value or read only the value of an individual register by clicking on any column for a particular register and clicking the *Read Selected Value* button. The GUI reads the register from the bq76PL455A-Q1 and updates the Value column for the selected register with the data read. When a register is selected, a small pointer appears in the far left column next to the address of the selected register.

Change this value by clicking on the Value column for a selected register. After doing so, the new value is stored to the RAM copy of the register on the bq76PL455A-Q1 by clicking the *Write Selected Register* button.

A register value is written to all bq76PL455EVMS in a stack by selecting a register then clicking the *Write Selected Broadcast* button.

Once a device has been configured as desired, the register settings are saved to a file using the *Export* button. The user is prompted for a folder and file name to which to save the register information.

The *Import* button is used to restore register values to values previously saved to register files using the *Export* button.

WARNING

The register files can also be viewed and modified external to the GUI with any text editor, but great care must be exercised when doing so, since register settings can put the IC into an undesirable state if mistakes are made in the register files and the data in a register file overwrites existing register values when imported.

The *Save all to EEPROM* button saves the values of all the registers which have a corresponding EEPROM location to the non-volatile memory in the bq76PL455A-Q1. Once this is done, the data is stored in the bq76PL455A-Q1 even after the power supply to the TOP pin of the device is removed. If the device is reset or power is re-applied after removal, the newly stored settings are loaded into RAM and used thereafter as the new configuration of the device. Due to the limited number of write cycles supported by the bq76PL455A-Q1, save to EEPROM as seldom as possible. As a reminder to limit this activity, a warning pop-up window appears anytime a save to EEPROM is requested. This warning window contains the recommended maximum and current write cycle count. An example of this warning window is shown in [Figure 15](#).

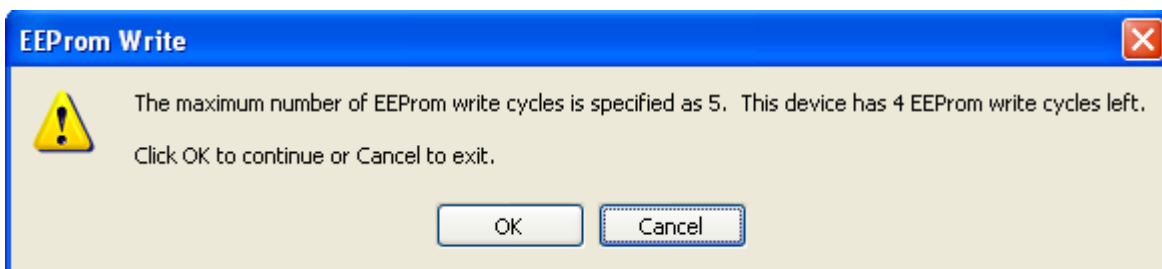

Figure 15. EEPROM Save Warning

The *Update Checksum* button is typically not used because the checksum is updated automatically by the GUI for most changes made while in Register View mode and either the *Write Selected Value* or *Write Selected Broadcast* button is clicked. However, in the event of an error or if a manual update is desired, clicking the *Update Checksum* button causes the value in the Checksum register to be updated to the proper value for the current register settings.

The *Hide* button, when clicked, closes the Register View window.

7.4 Comms Tab

In the *Comms* tab view, shown in [Figure 16](#), the following is allowed:

1. Set the baud rate at which the PC communicates with the bottom bq76PL455EVM in the stack (set to 250 kHz by default)
2. Issue a communications reset in the event communications with the bq76PL455EVMs have been compromised
3. Set the communications timeout and power down wait periods (disabled by default)

NOTE: The communication rate over the differential communication bus connecting multiple stacked bq76PL455EVMs is fixed and cannot be adjusted. Only the rate for the single-ended link to the PC is adjustable.

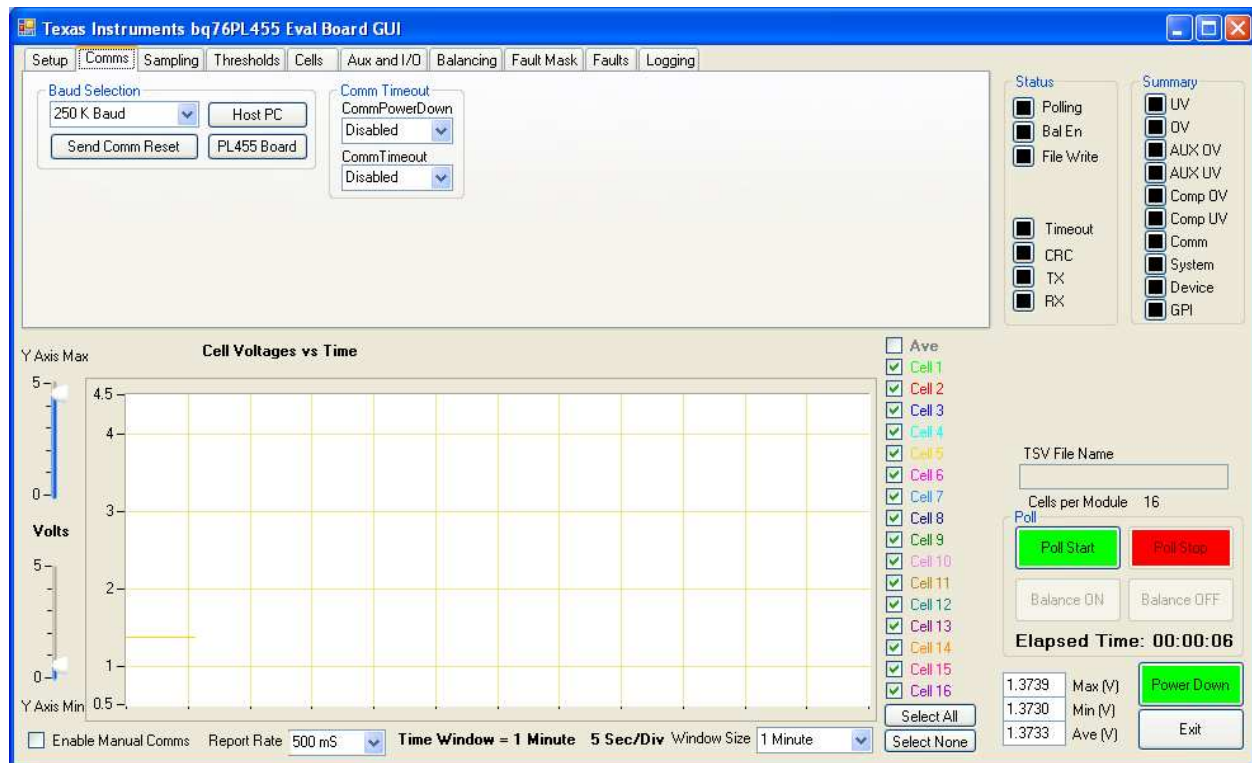

Figure 16. Comms Tab

Both the *Comm Timeout* value and the *Comm PowerDown* value can be *Disabled* or varied from 0.1 seconds to 1 Hour. These values (1) set the period after which a *COMM Timeout* fault is generated by the bq76PL455A-Q1 if it sees no bus activity and (2) set the period after which the bq76PL455A-Q1 enters its shut down state if it fails to see communication bus activity. By default both time out periods are disabled.

NOTE: In the event these timeout periods are enabled, the Power Down value should always be set to a period longer than the Timeout value so a fault is captured prior to a device shut down. This setting is not very useful in the context of the GUI, since no corrective measures are taken, but in a “real” system, a microprocessor is able to attempt communication recovery before an impending shut down of the system.

WARNING

It is important to note: during balancing, if the *COMM Timeout* is disabled and communication is lost with the GUI, balancing might continue draining cells below UV levels without tripping a UV error in the GUI. In a “real” system (as compared to a bench evaluation system) it is always advised to set a reasonable communications timeout value for safety reasons.

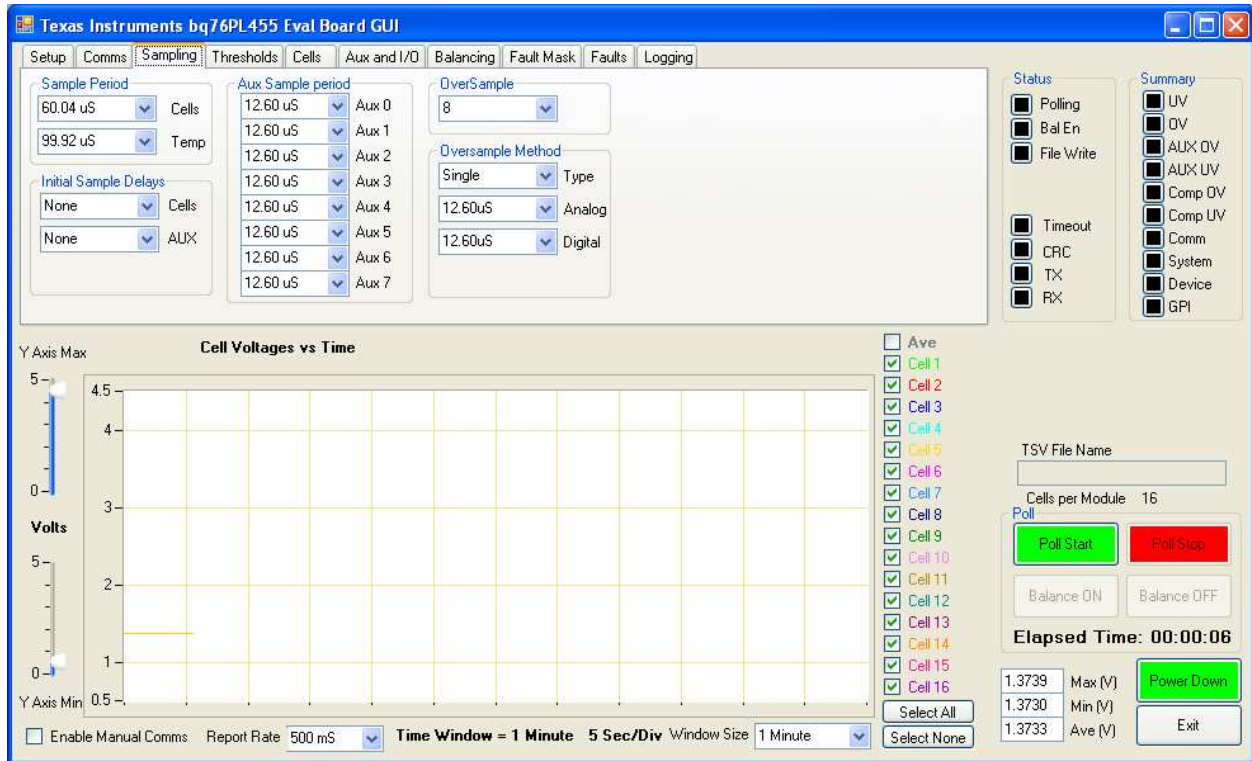

Figure 17. Sampling Tab

7.5 Thresholds Tab

The *Thresholds* tab, shown in [Figure 18](#), allows the following:

1. Set the cell undervoltage and overvoltage fault triggering thresholds
2. Set the comparator undervoltage and overvoltage fault triggering thresholds
3. Set the auxiliary channel undervoltage and overvoltage fault triggering thresholds

The cell voltage thresholds are varied between 0.0000 V and 4.9997 V.

The comparator overvoltage threshold is varied between 2.000 V and 5.175 V.

The comparator undervoltage threshold is varied between 0.700 V and 3.875 V.

The auxiliary channel undervoltage and overvoltage thresholds are varied between 0.0000 V and 4.9997 V.

The thresholds are changed by typing appropriate values into the selected text boxes. Since the bq76PL455A-Q1 has specific resolution restrictions for each of the settable thresholds, the GUI automatically adjusts the resolution of thresholds to the nearest available value to the number entered. This adjusted value is shown as soon as the input cell is deselected.

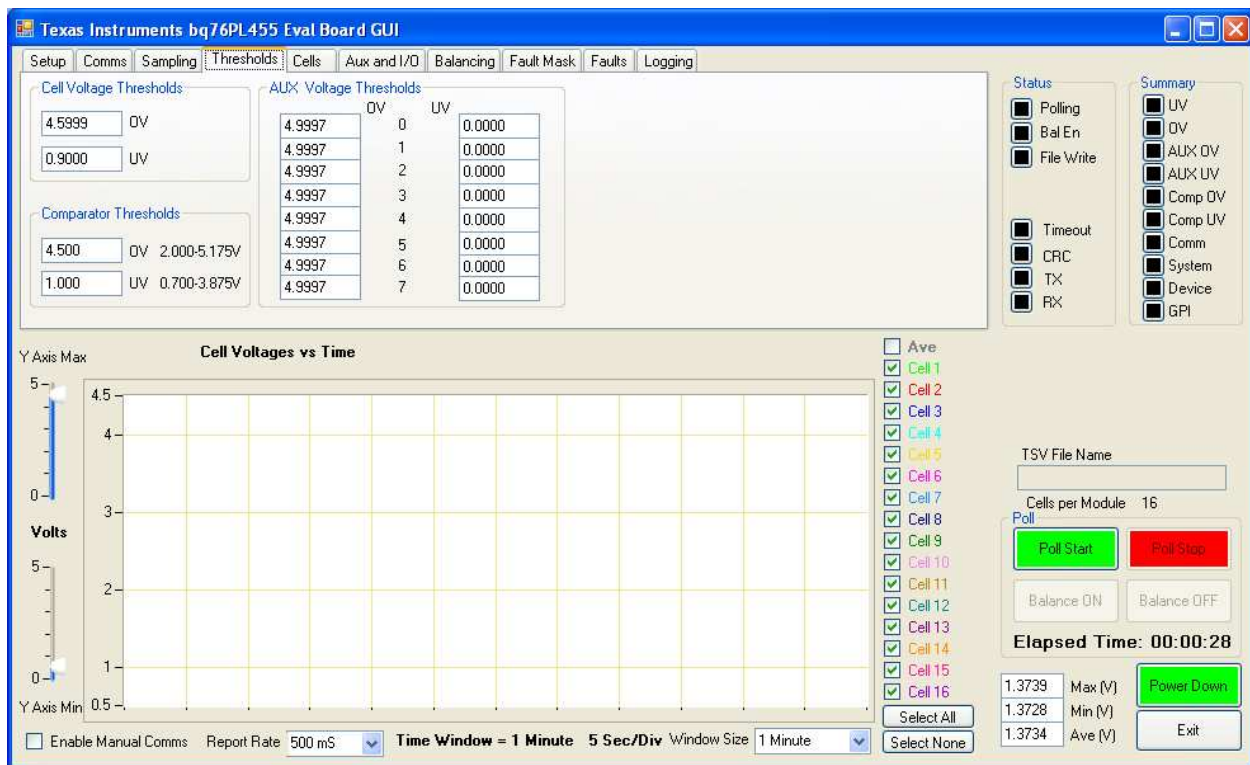

Figure 18. Thresholds Tab

7.6 Cells Tab

In the *Cells* tab, a graphical representation of the voltage on each cell is displayed, as shown in Figure 19.

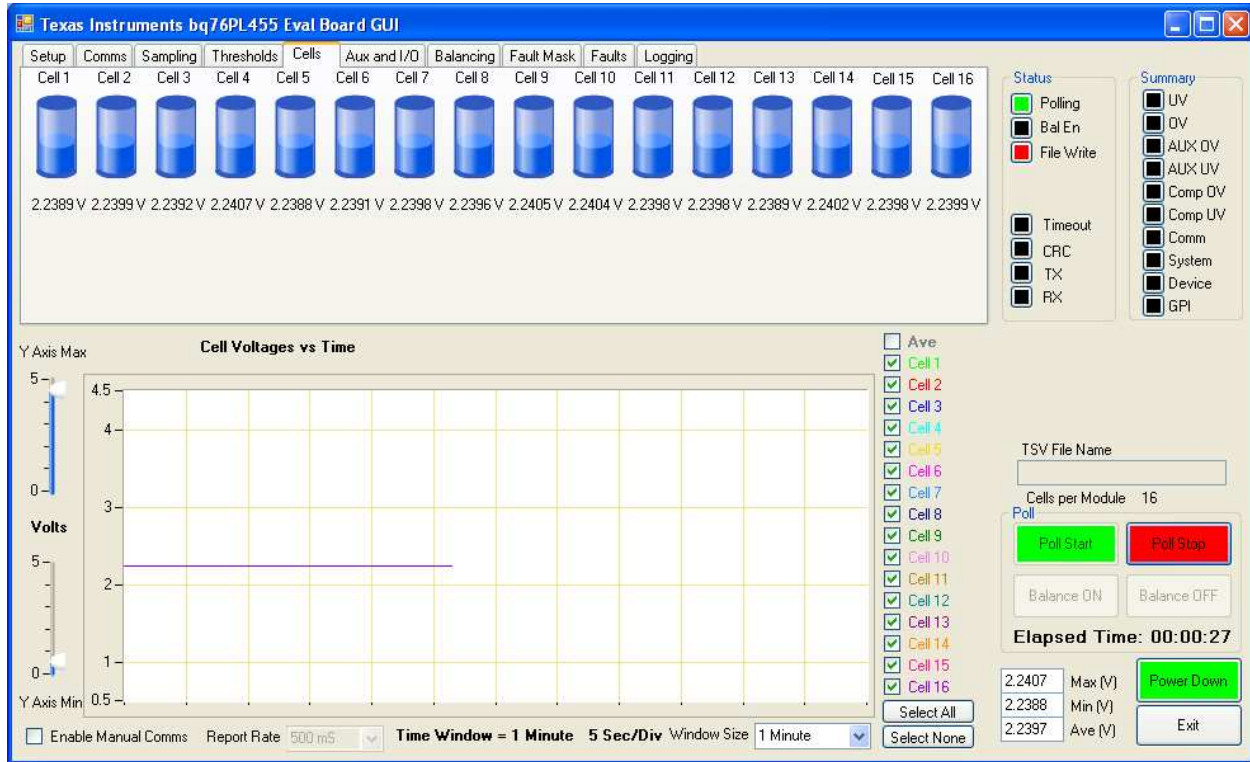

Figure 19. Cells Tab

7.7 Aux and I/O Tab

The *Aux and I/O* tab, shown in Figure 20 tab, allows observation of the voltage on each Aux input channel. The voltage shown is updated when polling is active. When polling is inactive, the last value polled is shown.

Only the specific Aux input channels selected on the *Setup* tab have their values actively updated on the *Aux* tab when polling is active. The value for any unselected Aux input channel is displayed as zero when polling is active and the unselected channels are greyed out to indicate they are inactive.

Additionally, the GPIO configuration options and states are indicated on this tab. Four separate configuration groups are provided:

1. GPIO Input Enable – Allows GPIO channels to be configured as inputs
2. GPIO Pull-up Enable – Allows for an internal pull-up to be enabled
3. GPIO Pull-down Enable – Allows for an internal pull-down to be enabled
4. GPIO Output State – Indicates whether a GPIO pin output driver is on when configured as an output

CAUTION

The bq76PL455A-Q1 does not prevent enabling of both the internal pull-up and pull-down resistors simultaneously, so exercise caution when selecting these options.

NOTE: Additional configuration is possible for GPIO pins configured as inputs. This additional configuration allows for the input to trigger a fault when changing state. This configuration is made on the *Fault Mask* tab.

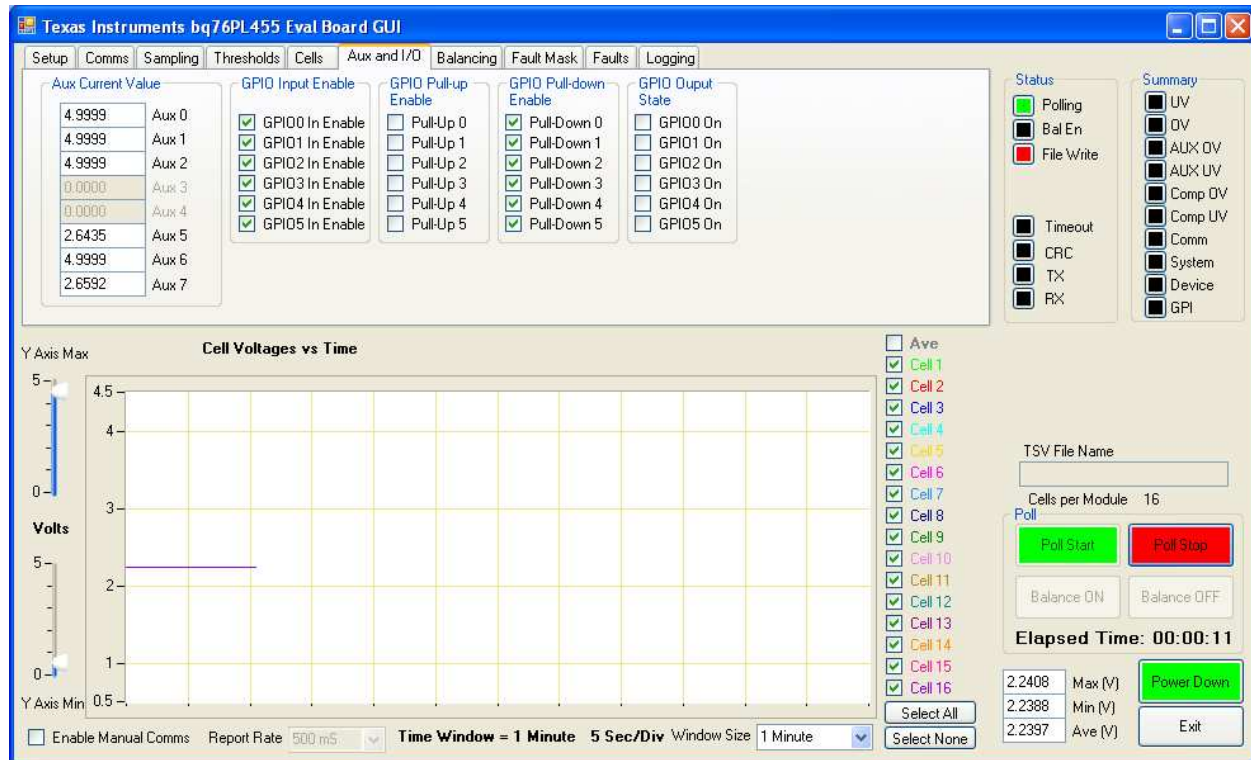

Figure 20. Aux and I/O Tab

7.8 Balancing Tab

The *Balancing* tab, shown in [Figure 21](#), allows selection of the cells which are balanced when the *Start Balancing* button is clicked and polling is active. In the specific example, balancing for cells 3, 5, 12, 13, and 14 is both enabled and turned on with polling active.

A small indicator appears to the right of the voltage/time grid, next to the appropriate cell, for each cell selected on the *Balancing* tab. This virtual LED indicator is black when balancing is off, green when balancing of a cell is on without faults and red if balancing is on and a fault has occurred.

NOTE: The example screen capture was taken with a resistor ladder consisting of alternating resistor values connected to the cell sense lines, so the effect is somewhat different from what is expected when battery cells are connected to the sense lines.

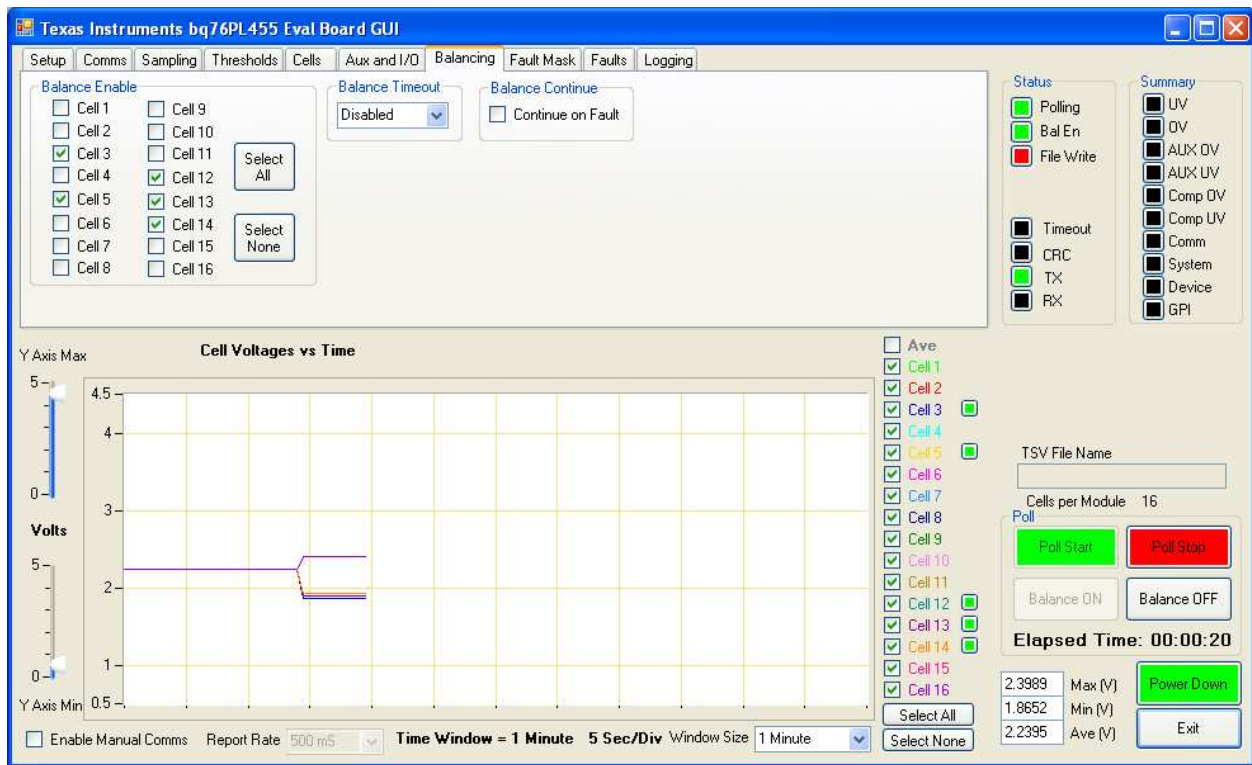

Figure 21. Balancing Tab

7.9 Fault Mask Tab

The *Fault Mask* tab, shown in Figure 22, allows the user to turn off and mask faults from various events and select which faults trigger the active low FAULT* pin on the bq76PL455A-Q1. Faults are grouped by type and correspond to their register locations. Further details regarding the faults and their meanings are found in the bq76PL455A-Q1 data sheet ([SLUSC51](#)).

NOTE: Any triggered fault, if left unmasked, prevent the ability to enable balancing unless the bq76PL455A-Q1 is set to continue balancing in the presence of a fault (by checking the *Continue on Fault* checkbox on the Balancing tab).

The *Fault Mask* tab also allows configuration of the General Purpose Input (GPI) pins to trigger faults when they change state. This configuration is done in the *GPI Faults (check to enable)* group box in the upper right portion of the *Fault Mask* tab.

The sample screen shot shows GPI0 and GPI1 configured such that a fault is triggered when the inputs change from Hi to Lo (and the screen shot shows that such a transition has occurred because the GPI fault indicator is red). In this case, since the GPI_FAULT_OUT box is checked in the *Fault Output Control (check to enable)* group box, expect the active low FAULT* output pin of the bq76PL455A-Q1 to be low, indicating an active fault.

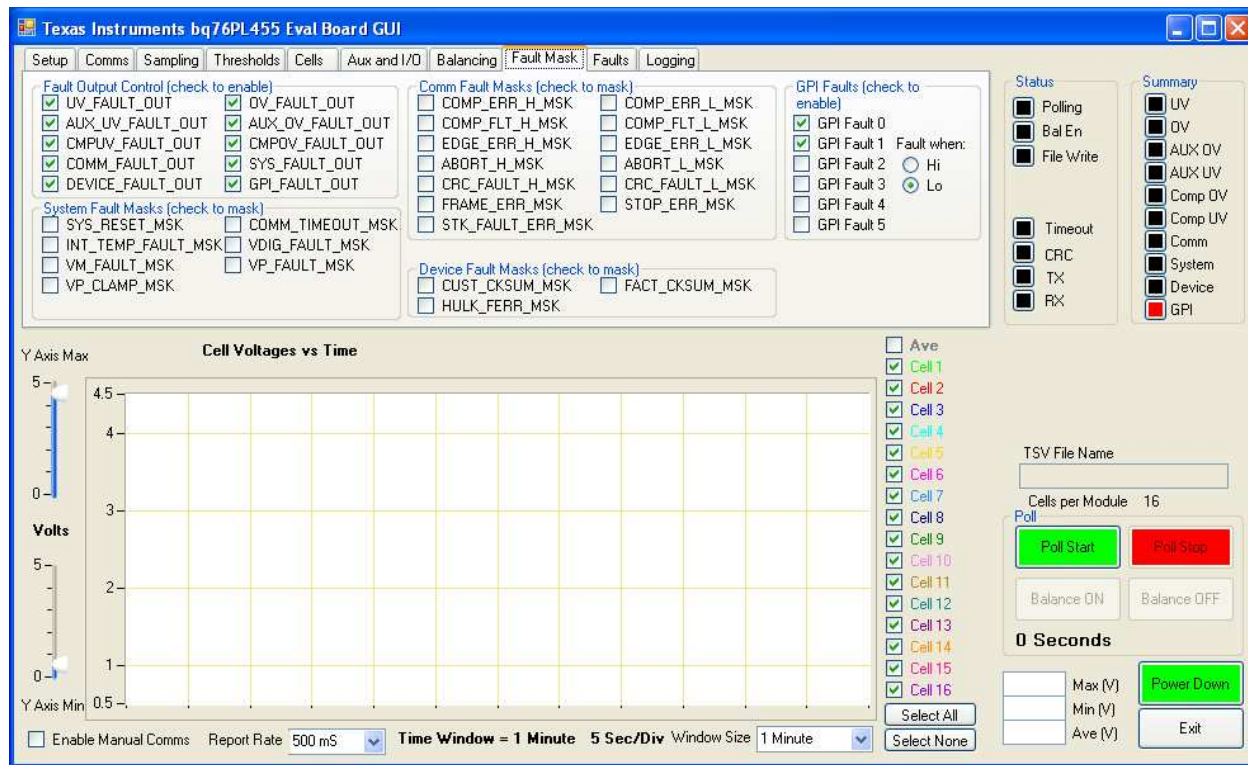

Figure 22. Fault Mask Tab

7.10 Faults Tab

The *Faults* tab, shown in Figure 23, provides a more in-depth breakdown of the cause of any faults shown in the *Summary* box in the upper right-hand corner of the GUI. In Figure 23, the data was acquired using a resistor ladder connected to a power supply, and the voltage on the power supply was slowly decreased so the voltage at all Vsense inputs decrease simultaneously. The threshold for the Undervoltage Fault detection was set to 2 Volts, so when the voltage decreased to that level at the Vsense inputs, all of the channels generated a UV Fault. Additionally, GPI faults for GPIO and GPI1 are shown as active faults.

Clicking any fault indicator (that is, any indicator lit in red) clears the associated fault. This includes:

- All *System Fault* sources including *Comm Timeout* and *Sys Reset*
- All Chip Fault sources
- All individual cell overvoltage and undervoltage faults
- All individual comparator overvoltage and undervoltage faults
- All AUX input overvoltage and undervoltage faults
- All individual GPI Fault sources

Clicking on any lit fault indicator in the *Fault Summary* box in the upper right-hand corner of the GUI clears all individual faults within that category of faults. For instance, the example in Figure 23 shows that clicking *UV* in the *Fault Summary* box clears all the *UV* faults in the *Cell Faults* box on the *Faults* tab.

If a summary or individual fault indicator is cleared and the fault persists in the hardware, the fault indicator shows the fault again the next time it is polled. Perform a manual poll of all fault conditions by clicking on the *Query All* button.

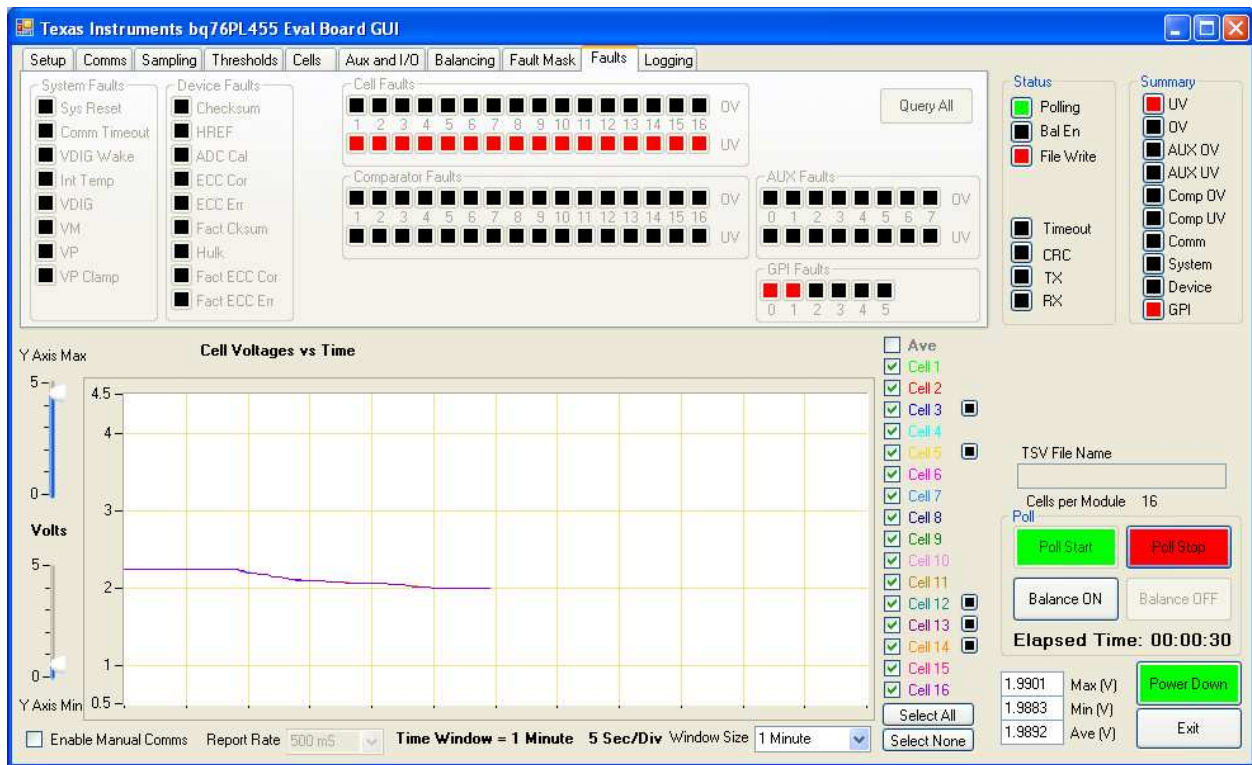

Figure 23. Faults Tab

7.11 Logging Tab

All the cell voltage data and configuration settings can be saved as a Tab-Separated Value (.tsv) file locally on the PC. Under the *Logging* tab, shown in [Figure 24](#) and [Figure 25](#), the user can turn on logging, choose the file name to which data is saved, and set the location where the log data file is saved.

The *Enable File Write* check box controls whether logging is enabled and the *Auto File Name* check box controls whether a file name is automatically generated or whether a name must be specified. To specify a file name and location, click the *Specify TSV file* button and enter the log file path and name. Notes are added in the notes dialog box and appear in the log file.

If *Auto File Name* is left un-ticked, the GUI appends new data to the same file name specified each time polling is started. Selecting *Auto File Name* and *Enable File Write*, by default, cause the GUI to generate log files on the desktop with file names in the format *TI_yymmdd_hhmmss.tsv*, where the automatically generated digits are based on the date (year, month, day) and time (hour, minute, second). A specific example is *TI_140102_111909.tsv*, in which the date and time are 2014, January 2, and 1100 hours, 19 minutes, and 09 seconds.

TIP: Un-ticking the *Auto File Name* box, entering a file name and location, and then ticking the *Auto File Name* box, prompts the GUI to start auto-generating file names in the selected path. If the GUI is shut down cleanly at the end of the session, it remembers to store in that location next time as well, avoiding a desktop littered with log files!

The *Log All Boards* check box controls whether only the data from the currently viewed bq76PL455EVM address or the data from all bq76PL455EVMs in the system is logged to the appropriately specified log file(s). If the *Log All Boards* check box is selected, the log file name is appended with *_00*, *_01*, *_02*, and so forth. This appended extension to the specified file name is the address of the bq76PL455EVM from which the data were collected.

An example log file is provided in [Appendix A](#). View log files with any text editor or a spreadsheet viewer such as Microsoft Excel®.

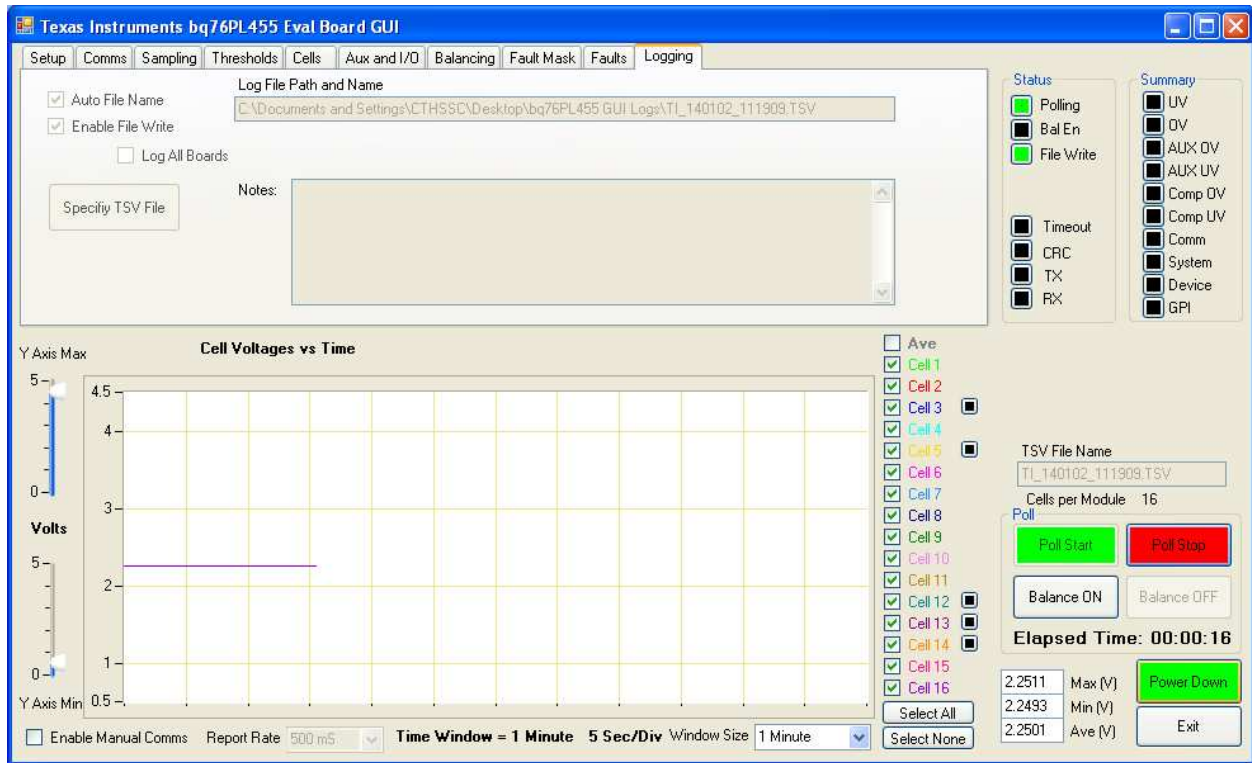

Figure 24. Logging Tab, Auto File Name

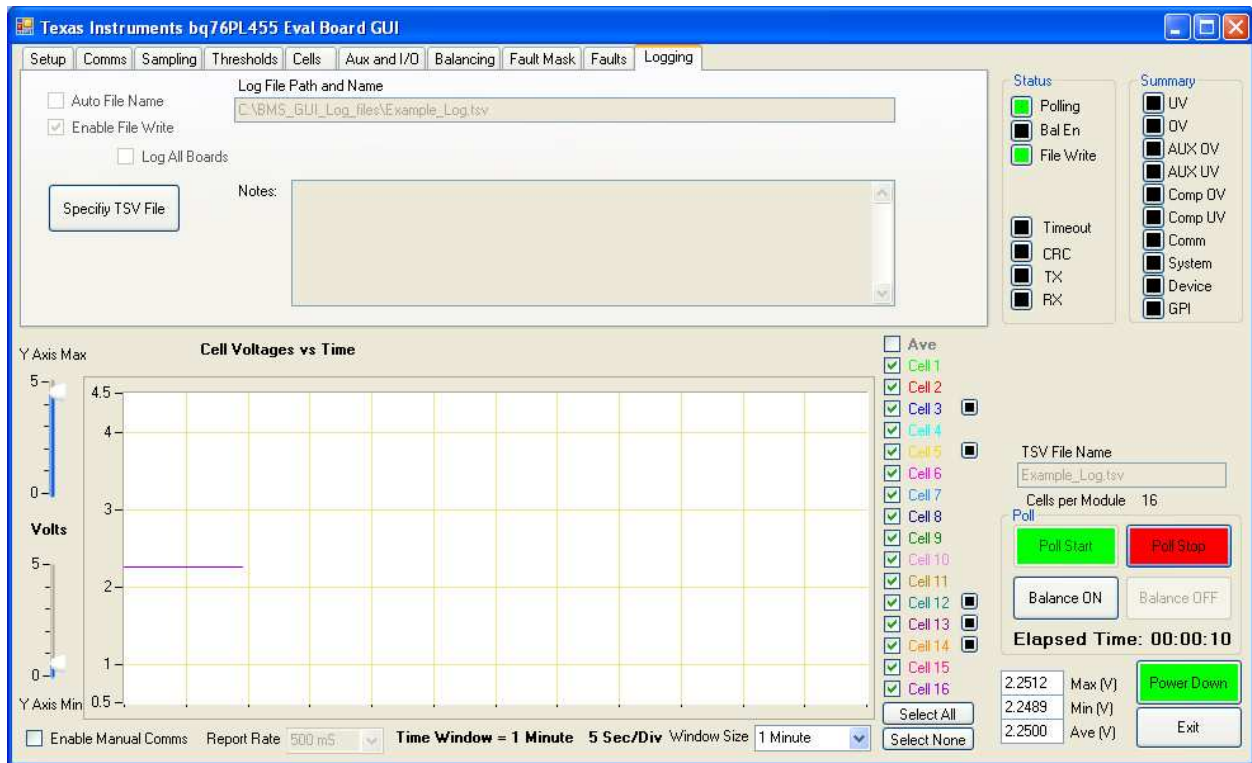

Figure 25. Logging Tab, User-Specified File Name

7.12 Stopping and Starting Polling and Balancing

Once the hardware is set up and the GUI settings have been defined, the user can begin polling cell voltage data, temperature and auxiliary input data, and enable and disable balancing.

Near the lower right-hand corner of the GUI in the *Poll* group box, find the *Poll Start* button highlighted in green. When clicked, the GUI begins polling cell voltage and auxiliary input data. Set the polling rate by using the *Report Rate* drop-down menu found below the graph. Define a polling rate of 200 ms to 5 seconds, though it is recommended to use a rate no faster than 500 ms, which is the default rate selected. The data can be saved to a user-defined .tsv file using controls on the *Logging* tab. The cell voltage data is displayed in real time across the *Cell Voltages vs Time* graph, as seen in Figure 19. Change the time scale using the *Window Size* drop-down menu, and define the time scale from 1 minute to 12 hours. The voltage scale is changed using the sliders to the left of the graph.

The *Balance ON* and *Balance OFF* buttons start and stop balancing, respectively. The *Balance ON* and *Balance OFF* buttons are not enabled unless at least one cell has been selected on the *Balancing* tab. Also, the *Balance ON* button is not enabled if the bq76PL455A-Q1 is already balancing, and the *Balance OFF* button is not enabled if the bq76PL455A-Q1 is not already balancing.

If there were no faults during the activation of the balancing function, the green balancing status LED (*Bal En*) near the upper right hand corner of the GUI screen and cell balancing indicators next to selected cell(s) turns green. If, on the other hand, a fault occurred during balance enabling, the balancing status LED (*Bal En*) turns red, and all balancing is disabled. For safety, clear all faults before balancing is restarted.

As shown in the Cell 10 example in Figure 26, when balancing is enabled, the voltage of the balanced cell in the *Cell Voltage vs Time* view drops. It can also be seen that during balancing, the measurement of the adjacent Cells 9 and 11 is also affected as these share common sense lines in the battery cable. It is important to understand that measurement accuracy is affected by the balancing process and is due to the presence of the balancing current flowing in the measurement sense lines which have non-zero resistance.

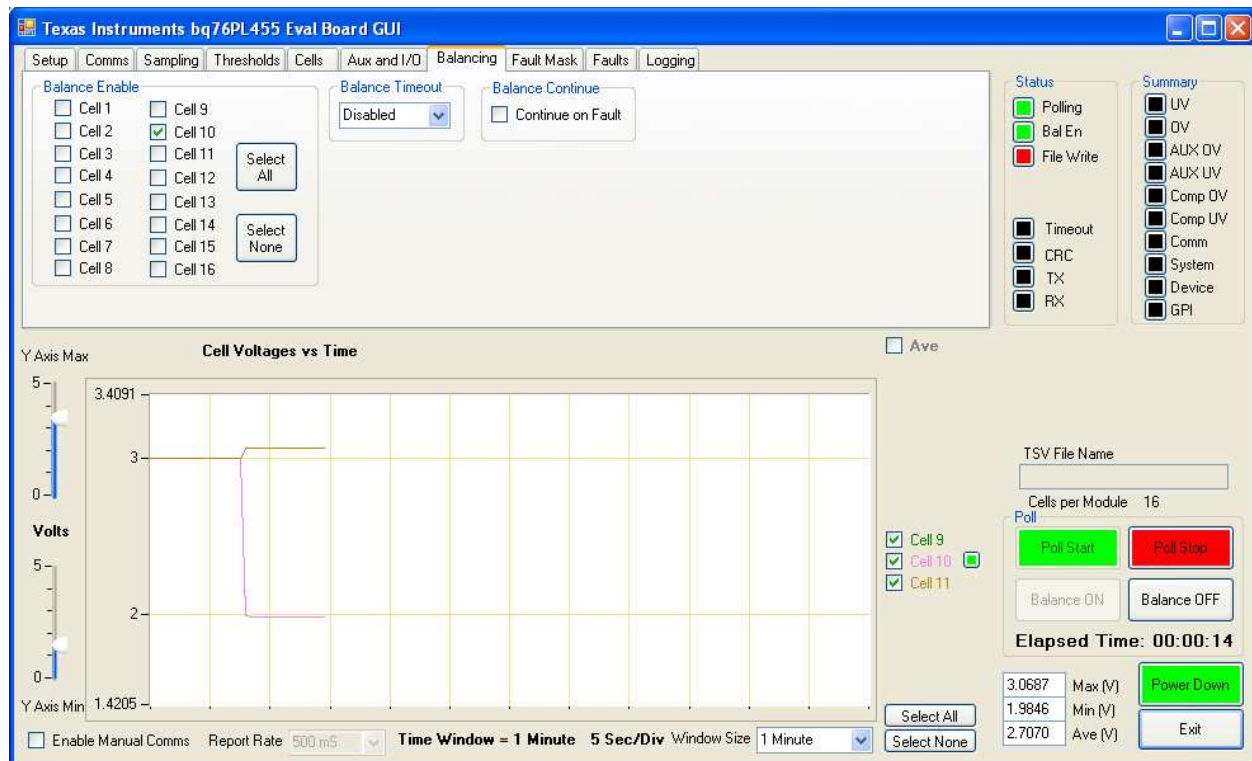

Figure 26. Cell 10 Balancing Example

The example shows a significant drop in voltage when balancing is enabled because the test data were captured using a resistor ladder board and a power supply. If the input sense lines had been connected to a battery pack, this drop would have been much less severe. However, a small decrease in voltage for any channel being balanced is expected, and this could cause the voltage on a selected channel to drop below a user selected undervoltage threshold, thus causing a UV fault. If the *Continue on Fault* checkbox is not checked, then balancing in this condition stops automatically. This condition is shown in Figure 27, in which the UV Fault Threshold was set to 2.1 V. The Bal_En indicator is red to indicate a fault stopped the balancing function.

In Figure 28, the same undervoltage threshold condition (2.1 V) was maintained, but the *Continue on Fault* checkbox was checked. Balancing is continuing despite a UV fault (and a Device (Checksum) Fault). The Bal_En indicator is green showing that balancing is still functioning, despite the indicated faults.

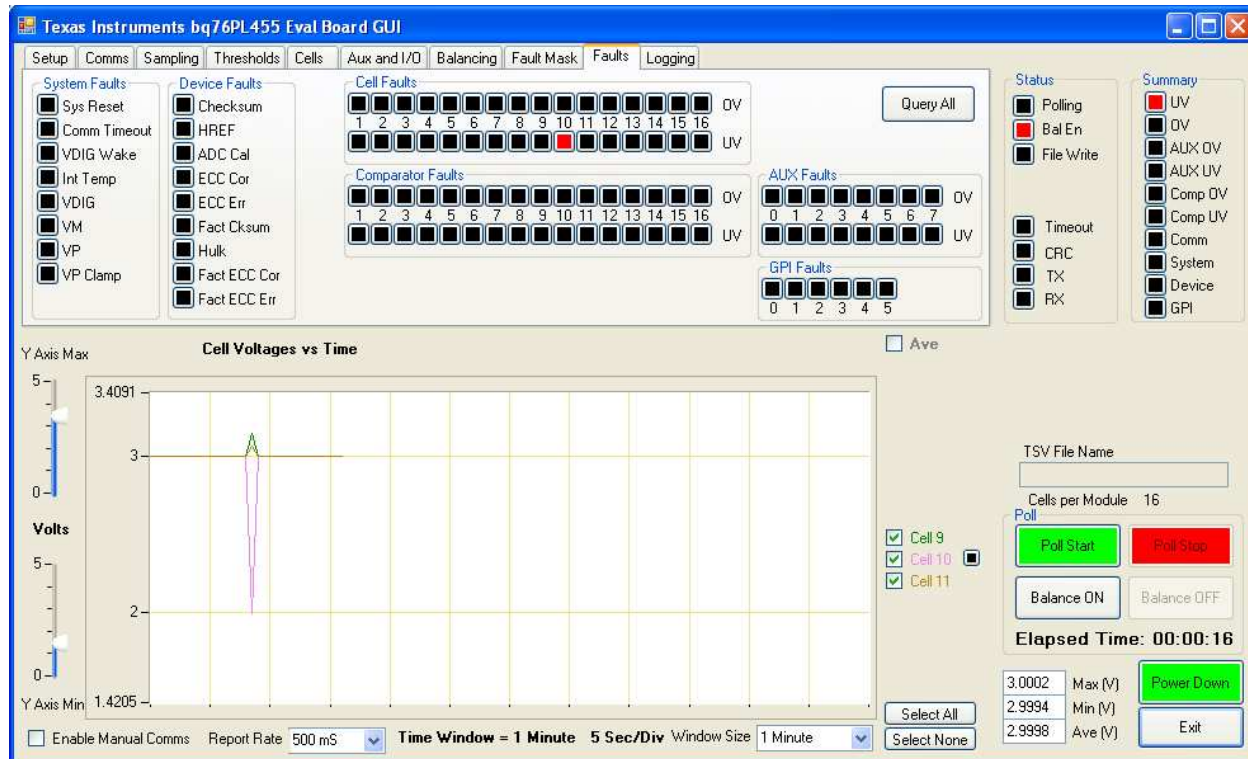

Figure 27. Aborted Balancing Due to UV Fault

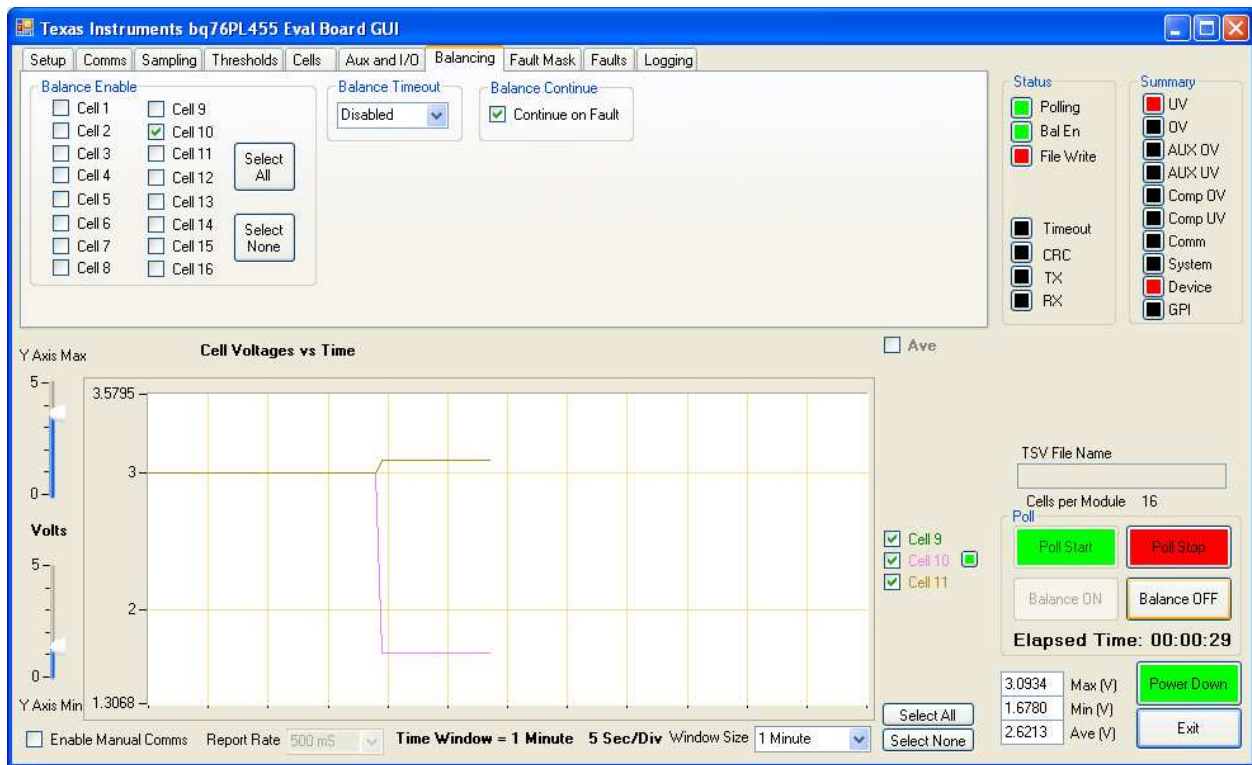

Figure 28. Balancing during UV Fault

7.13 Manual Command Window Extension

The GUI has the capability to send a custom “manual” command to the bq76PL455A-Q1 device(s) connected to the PC. This capability is enabled by checking the *Enable Manual Comms* checkbox in the lower left corner of the GUI. Checking this box enables a window extension as seen in [Figure 29](#).

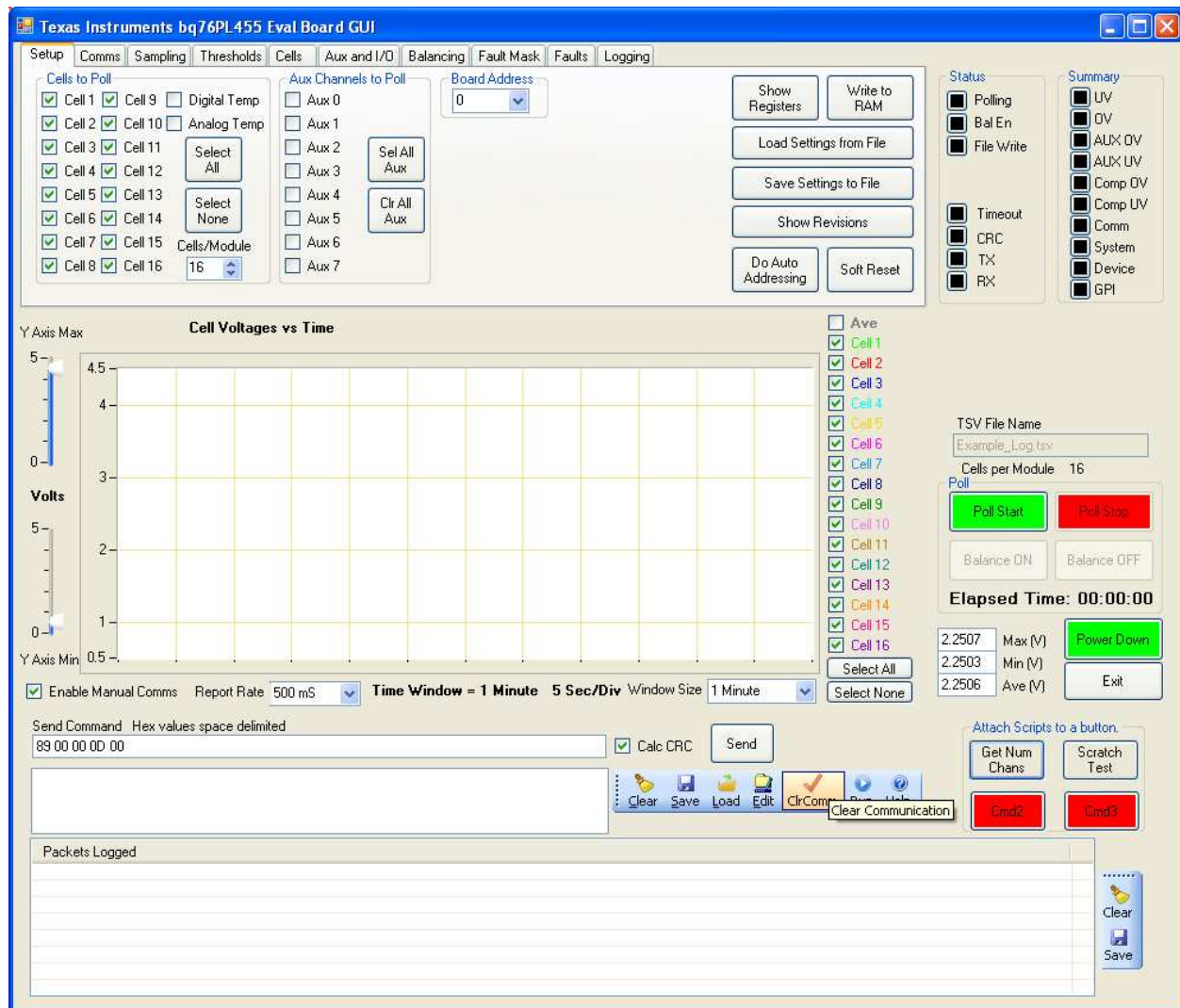

Figure 29. Manual Communications Window

7.14 Sections of the Manual Command Window Extension

The *Manual Comms* window extension is broken into four sections. The four sections are:

1. The *Send Command* window and the associated *Calc CRC* check box and *Send* button
2. The *Command* window and the associated menu bar with the *Clear*, *Save*, *Load*, *Edit*, *ClrComm*, *Run* and *Help* buttons
3. The *Script* buttons
4. The *Packets Logged* window and its associated menu bar with the *Clear* and *Save* buttons

The functions enabled by this window extension are powerful. Proper use of the functions require a thorough understanding of the messaging protocol employed by the bq76PL455A-Q1. For this reason, read and understand the bq76PL455A-Q1 data sheet's ([SLUSC51](#)) description of the message packet format before using the functions in this window extension.

CAUTION

If improperly formatted messages are sent to one or more bq76PL455A-Q1 devices using this interface, then it is possible to inadvertently change the behavior of one or more devices! Exercise great care when sending commands to connected devices.

7.14.1 The Send Command Window Section

A command is entered as a string of hexadecimal characters using the *Send Command* window. The command is later sent to one or more bq76PL455A-Q1 devices. Each command message string is made up of a header byte, several data bytes and two CRC bytes. To make it easier to form command strings, the GUI can calculate the CRC bytes if the *Calc CRC* box next to the *Send Command* window is checked.

Clicking the *Send* button next to the *Send Command* window moves the command in the *Send Command* window into the larger *Command* window and immediately sends the command. When the GUI is initially started, an example command string is loaded into the *Send Command* window. This example command (89 00 00 0D 00, without CRC) requests the data in register 13 from the first bq76PL455A-Q1 connected to the GUI (that is, the device with Device ID Address 0). Since the *Calc CRC* checkbox is checked by default, the command has the CRC bytes added to the command string before it is sent (that is, 89 00 00 0D 00 D9 4F).

7.14.2 The Command Window Section

Any command scheduled to be sent to the device(s) connected to the GUI is listed in the *Command* window. Commands listed in this window can come from either the *Send Command* window or a script file (explained in [Section 7.14.3](#)).

NOTE: Commands listed in the *Command* window have not necessarily been sent to the device. If the source of the command is the *Send Command* window, then the command has been sent. If the source of the command(s) is a script file, then the command(s) are not sent until the *Run* button to the right of the *Command* window is clicked.

Multiple commands are transferred to the *Command* window. These commands remain in the *Command* window until they are erased by clicking the *Clear* button to the right of the *Command* window. This is a convenient method for building scripts from within the GUI. Once one or more commands have been recorded in the *Command* window, the command(s) can be saved to a script file by clicking the *Save* button to the right of the *Command* window. Commands are saved to script files in plain text, so these files can be readily edited using any desired text editor. Reload and run script files later by clicking the *Load* and *Run* buttons, respectively.

Figure 30 through Figure 34 demonstrate how to load and run a previously saved script file.

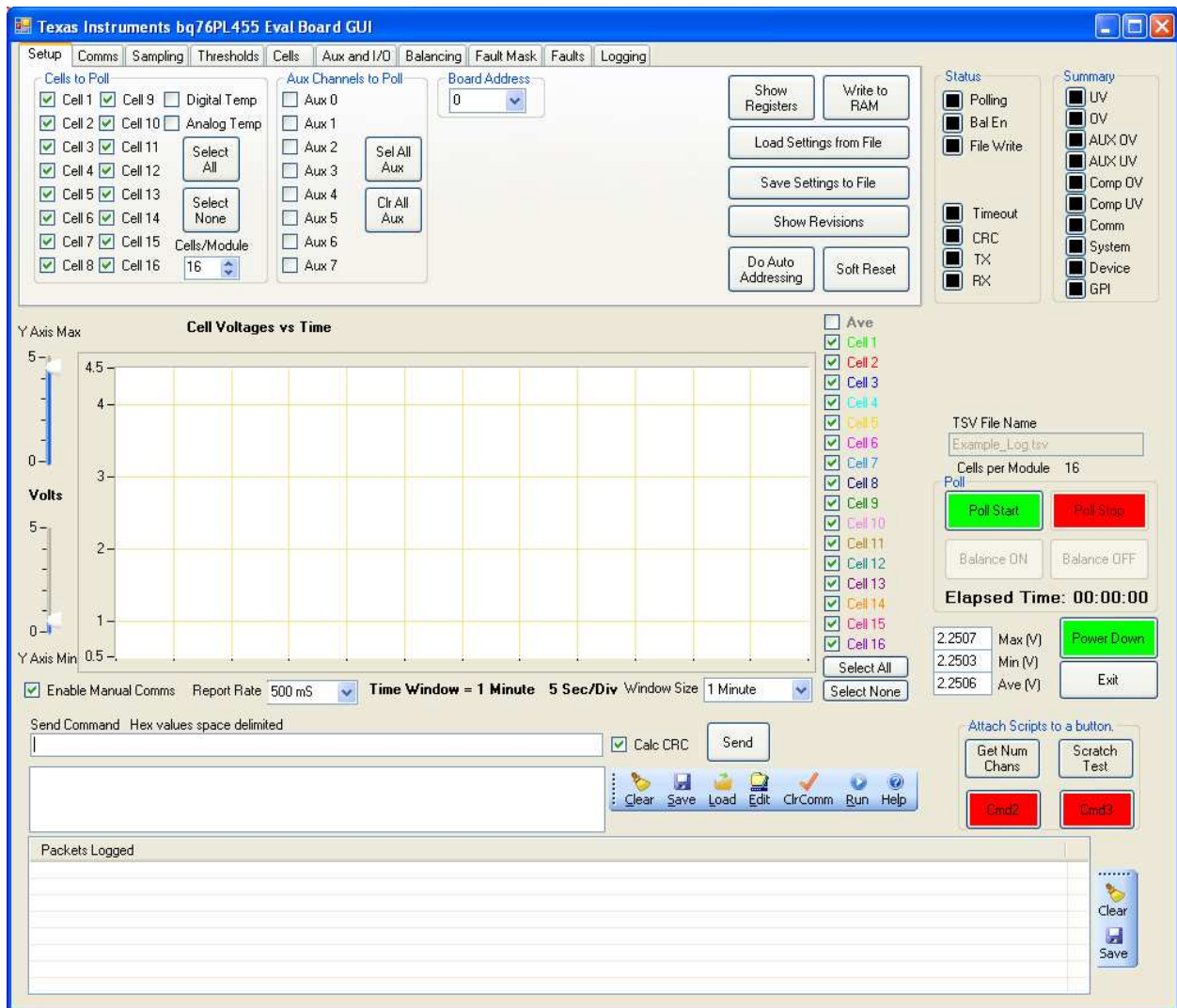

Figure 30. Ready to Load Previously Saved Script

Clicking the *Load* button brings up a script selection window. The window defaults to the last used directory, but this directory can be changed to any desired directory. In the example in [Figure 31](#), the script with the filename, “Sample – Broadcast Sample all Boards.txt” is selected.

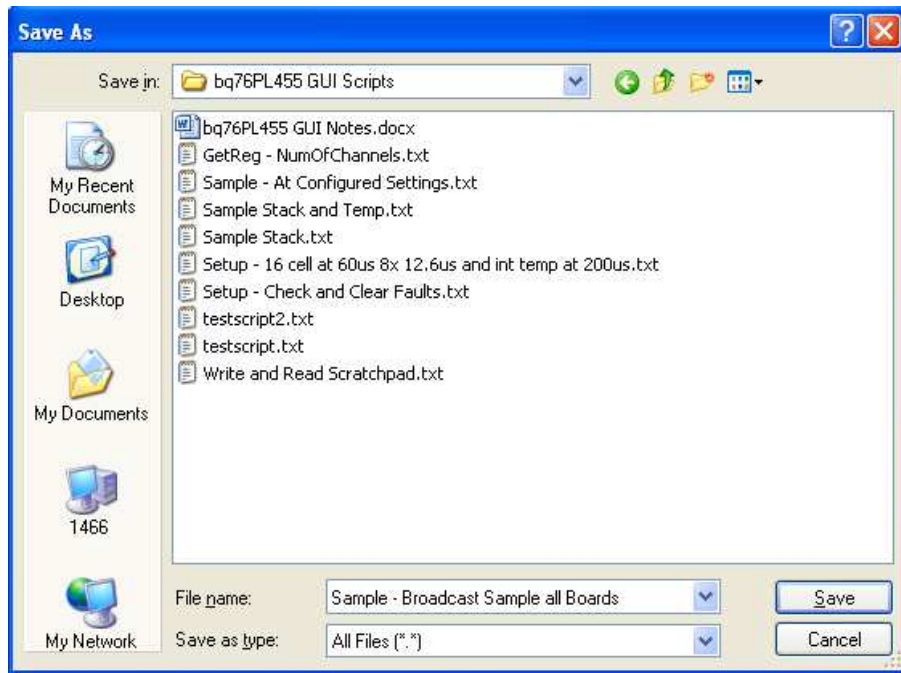

Figure 31. Load Script Selection Window

In this case, the selected script file contains only a single command. Upon loading, the script selection window automatically closes and the *Command* window contains the commands from the loaded script. (See [Figure 32](#)).

NOTE: If the *Command* window already contained a list of commands prior to loading the content of the script file, then the *Command* window contains both the previously loaded commands and the content of the script file. If this is not desired, then use the *Clear* button prior to loading a script file. However, by not clearing the *Command* window prior to loading one or more scripts, scripts can be concatenated. These concatenated scripts can then be saved just like a simpler script is saved.

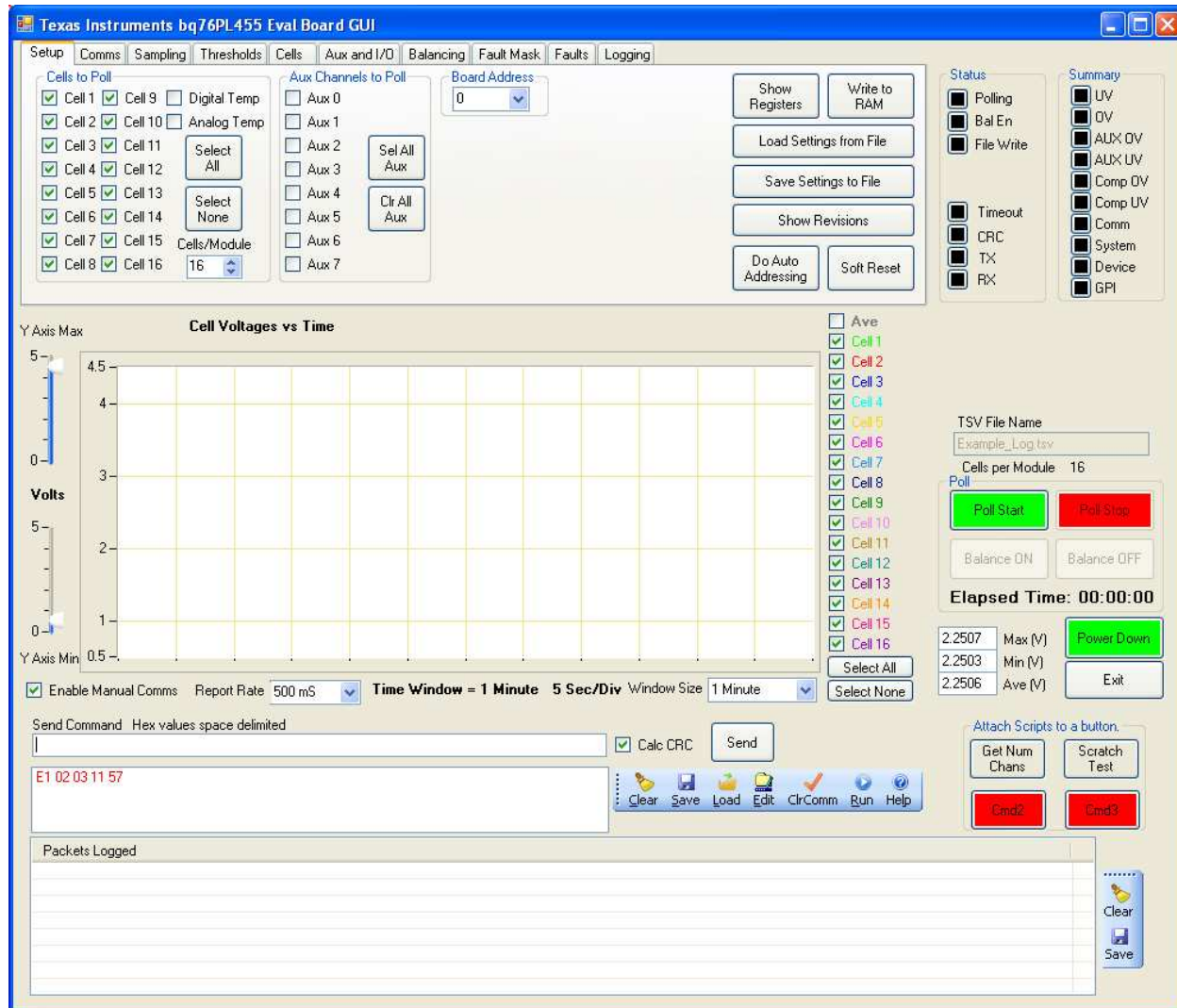

Figure 32. Loaded Script in Command Window

Clicking on the *Run* button to the right of the *Command* window causes the commands in the *Command* window to be sent to the bq76PL455A-Q1(s). In the case of this example, the command is a *Broadcast Write with Response* message to all connected bq76PL455A-Q1 devices, asking each connected device to sample all of its selected input channels and then return the sampled results. The resulting command and the responses are logged in the *Packets Logged* window as seen in [Figure 33](#).

Commands from the GUI to a bq76PL455A-Q1 device are logged in red and a response from a bq76PL455A-Q1 to the GUI is logged in blue. In the example case in [Figure 33](#), there are four bq76PL455A-Q1 devices connected to the GUI, so the *Broadcast Write with Response* command garnered four responses, each of which appears on its own line in the *Packets Logged* window.

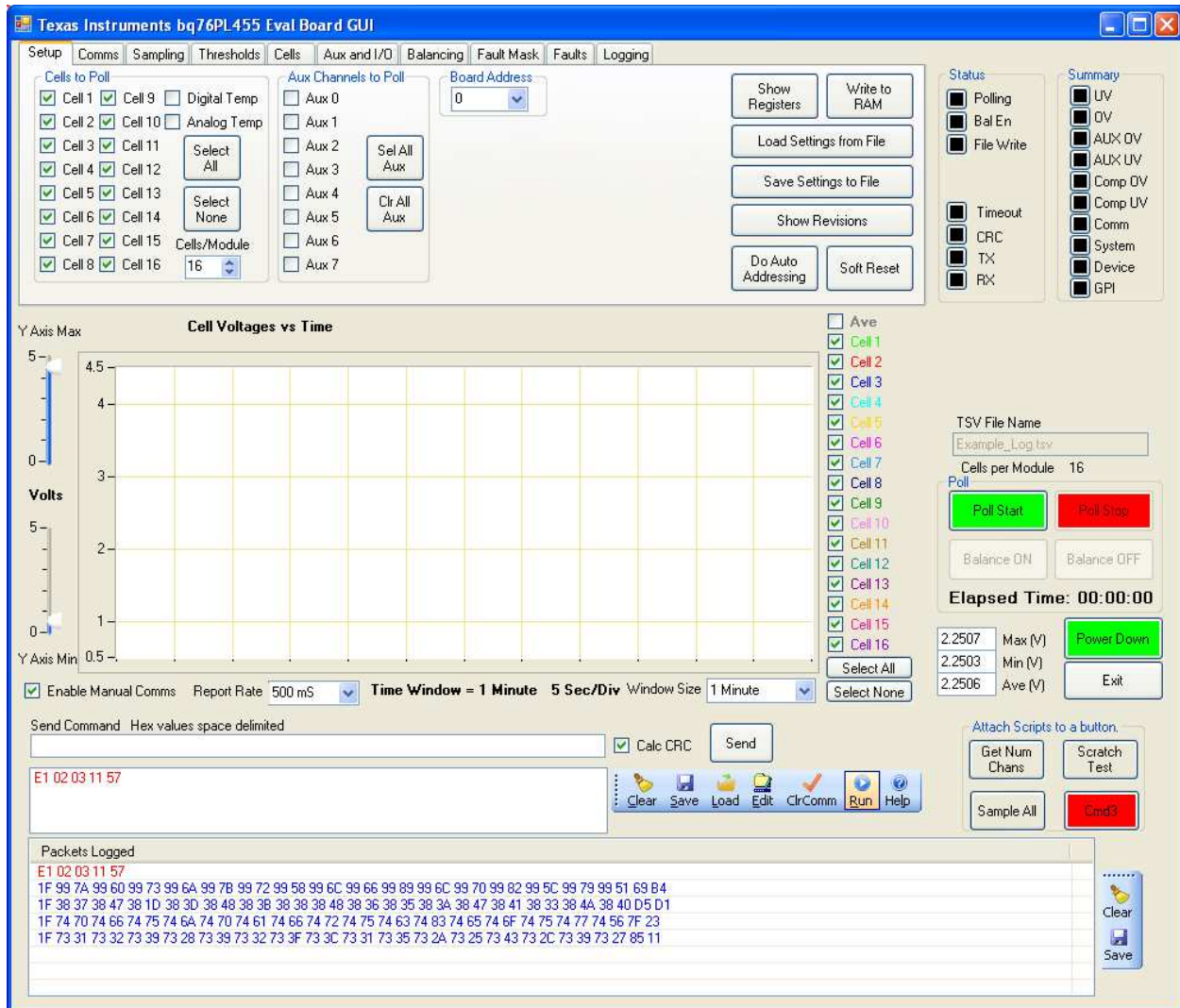

Figure 33. Broadcast Command Responses

In the event an improper command is sent which disrupts communication between the GUI and the bq76PL455A-Q1, clicking the *ClrComm* button to the right of the *Command* window attempts to restore the communications interface.

At any time, help on how to use the scripting capabilities of the GUI is available. The *Help* button to the right of the *Command* window provides a pop-up window with useful information on how to use the system. A sample of the *Command Help* window is seen in [Figure 34](#).

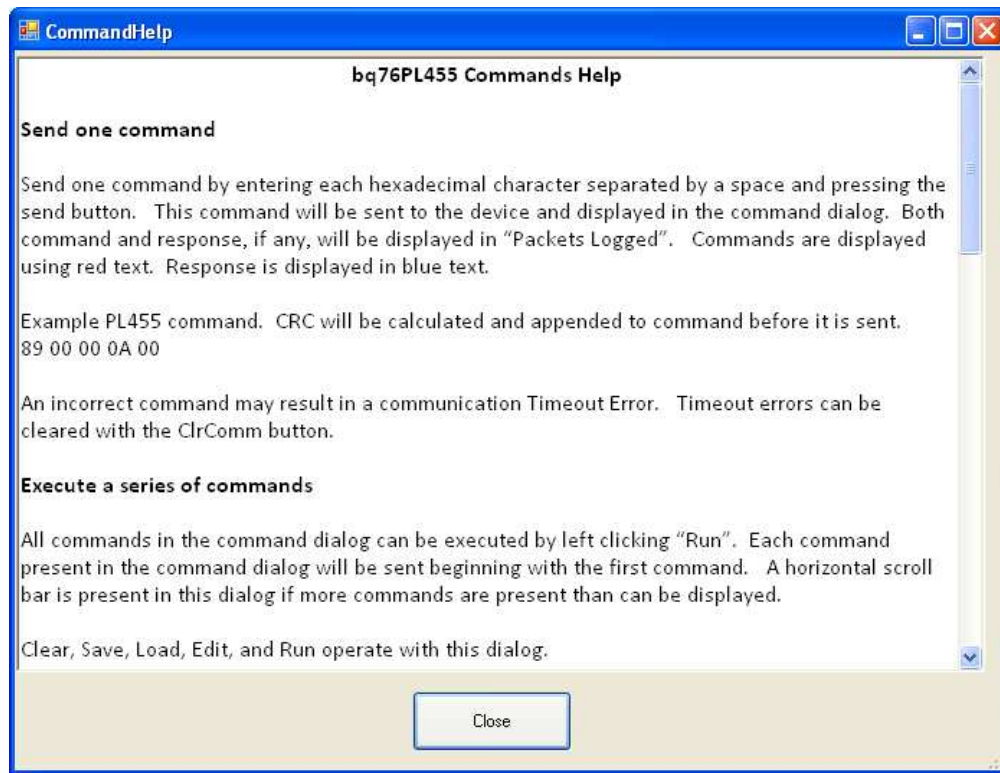

Figure 34. Manual Command Entry Help

7.14.3 The Script Button Section

Scripts can be attached to four buttons. When the GUI is started for the first time, all script buttons are unassigned to scripts and have a red background color. By default, the names of the script buttons are Cmd0, Cmd1, Cmd2 and Cmd3. Once a script has been assigned to a button, the background color changes from red to grey and a user-supplied name shows on the button face.

Assign a script to a button by right-clicking on the desired button. This action brings up a script selection window similar to the one in [Figure 35](#).

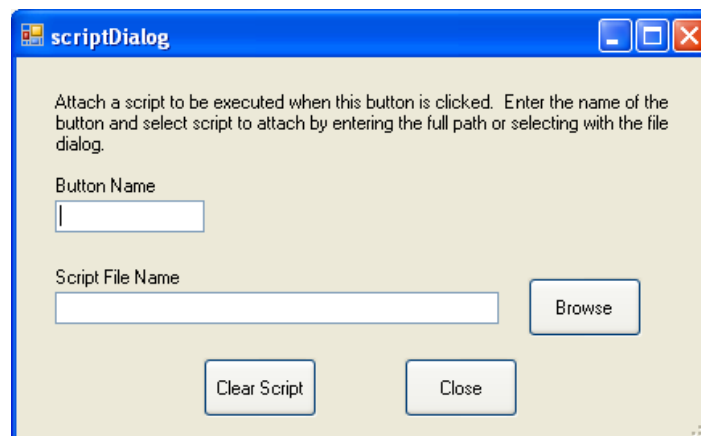

Figure 35. Script Assignment Window

For the example in this document, the “Sample – Broadcast Request to All.txt” script is assigned to the Cmd2 script button, and the button is renamed, *Sample All*. The new button name is simply typed into the *Button Name* box in the Script Assignment Window. Clicking the *Browse* button brings up a selection window similar to that in Figure 36.

Once the desired script and new button name are selected, the *Script Assignment* window should look similar to the window as shown in Figure 37. All that remains now is to click *Close* to finish the assignment process. The resulting GUI screen with the newly assigned button name is seen in Figure 38.

Script button assignments are remembered between GUI sessions, so assigning scripts to buttons is a good way to have commonly used scripts available for future use without the need to manually load them every time the GUI is re-started.

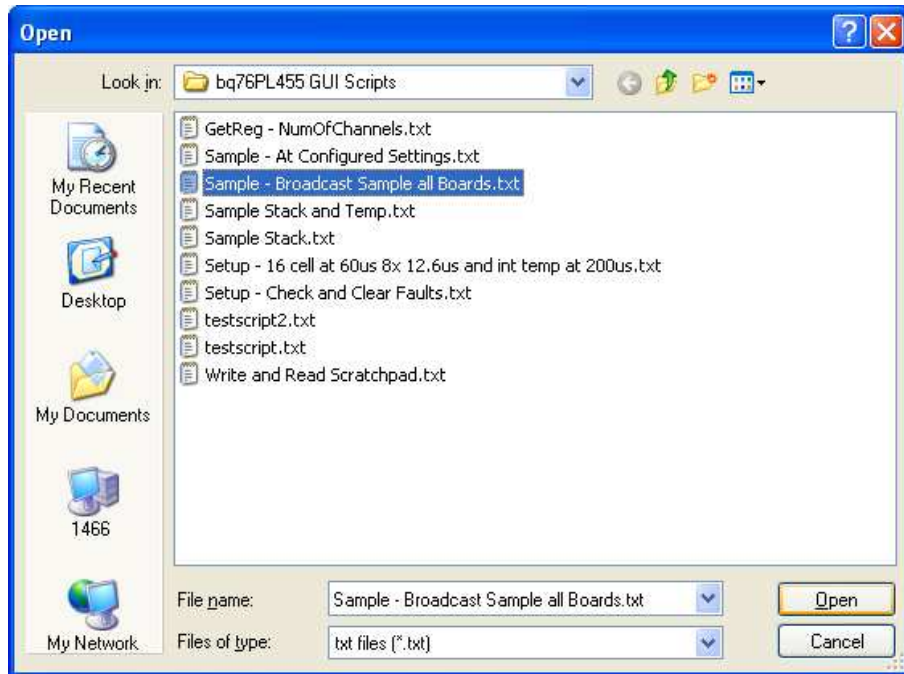

Figure 36. Script Selection Window

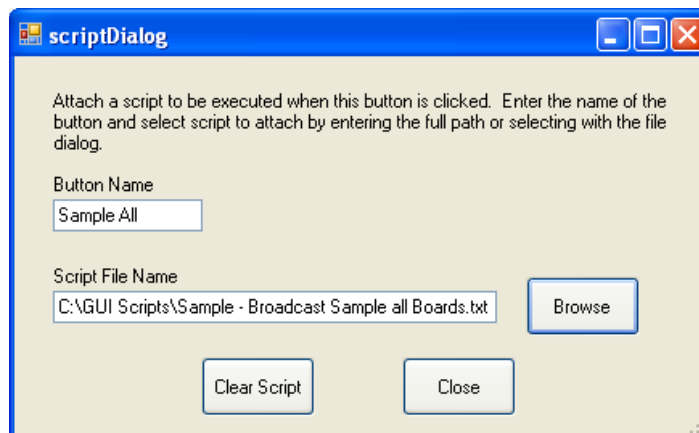

Figure 37. Ready to Assign Script to Button

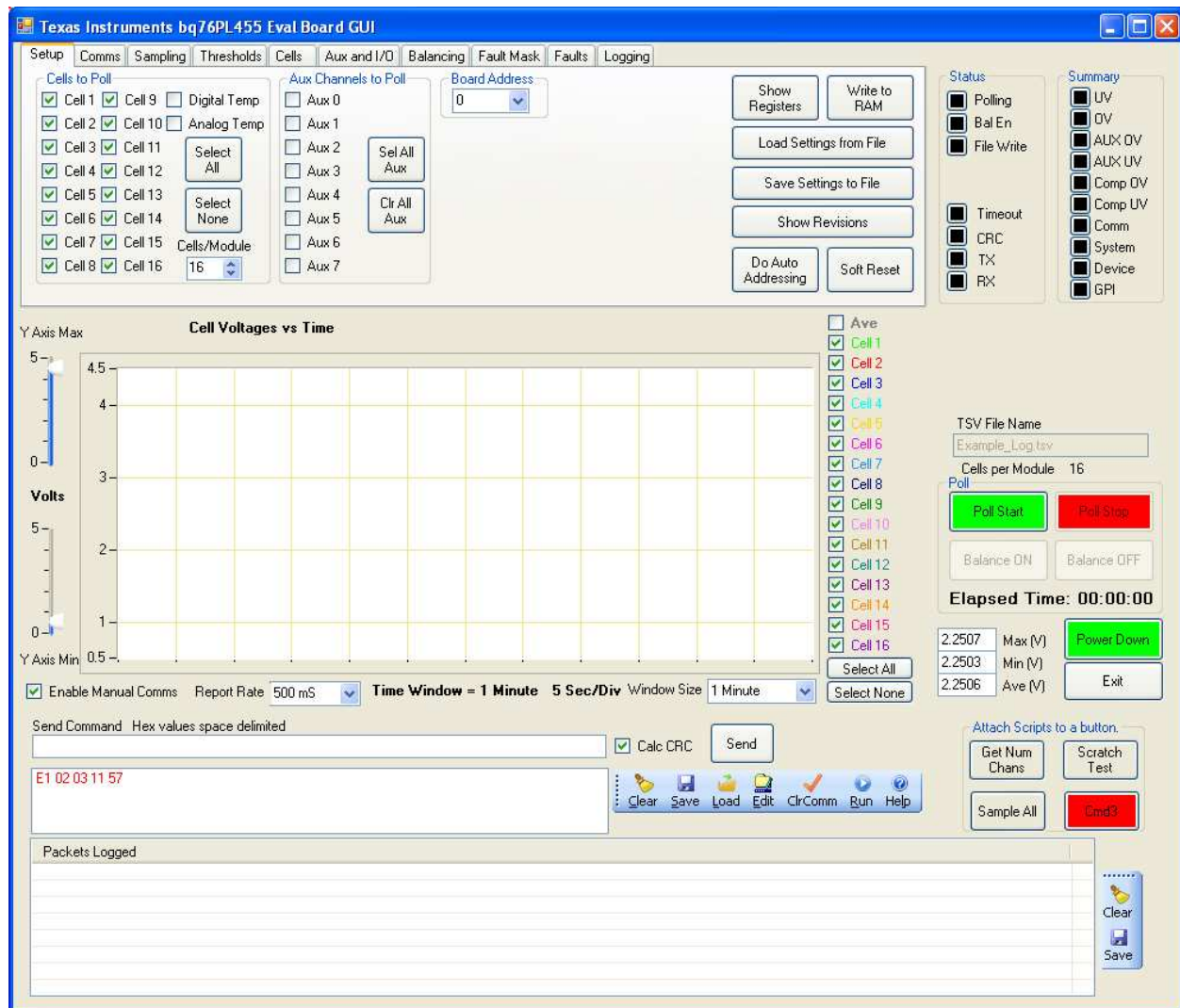

Figure 38. Script Assigned to Button

7.14.4 The Packets Logged Window Section

The *Packets Logged* window provides a running history of the “manual” command and response traffic between the GUI and any connected bq76PL455A-Q1 devices. As previously mentioned, commands from the GUI to a bq76PL455A-Q1 device are recorded in red, whereas a response from a bq76PL455A-Q1 device to the GUI is recorded in blue.

The packets logged in this window are saved to a file by clicking the *Save* button to the right of the *Packets Logged* window. The *Packets Logged* window is cleared of data by clicking the *Clear* button to the right of the *Packets Logged* window.

In the event large responses are logged, packets containing more than 55 bytes may not appear fully within the *Packets Logged* window. Data not visible in the window is viewed in a log file created as described in the previous paragraph.

7.15 Script File Format

The script files referred to in the previous section are simple text files. These files are created and edited from within the GUI or they are created and edited using any desired text editor. [Figure 39](#) shows the content of the “Sample – Broadcast Sample All Boards.txt” script used in previous examples in this document.

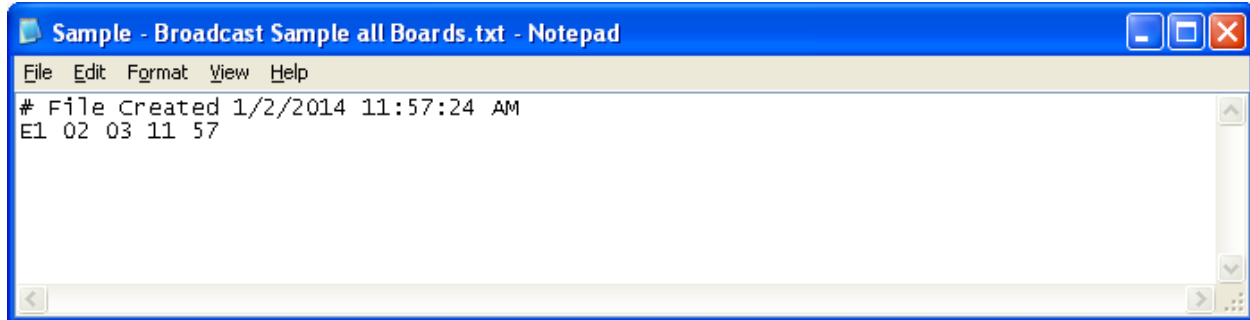

```

Sample - Broadcast Sample all Boards.txt - Notepad
File Edit Format View Help
# File Created 1/2/2014 11:57:24 AM
E1 02 03 11 57
    
```

Figure 39. Sample Script

The GUI created this script file and it contains a standard header added by the GUI. This header is in the form of a comment, indicated by the “#” character at the start of the line. The header line indicates the data and time of creation.

Any line starting with the “#” character is treated as a comment and does not generate any commands.

Hexadecimal characters, such as “E1 02 03 11 57” in this example, are treated as commands. Place each desired command on its own line. Commands are executed in series.

Format user-created or edited files to include more descriptive text, thus providing a better understanding of the purpose of the script. [Figure 40](#) shows an example.

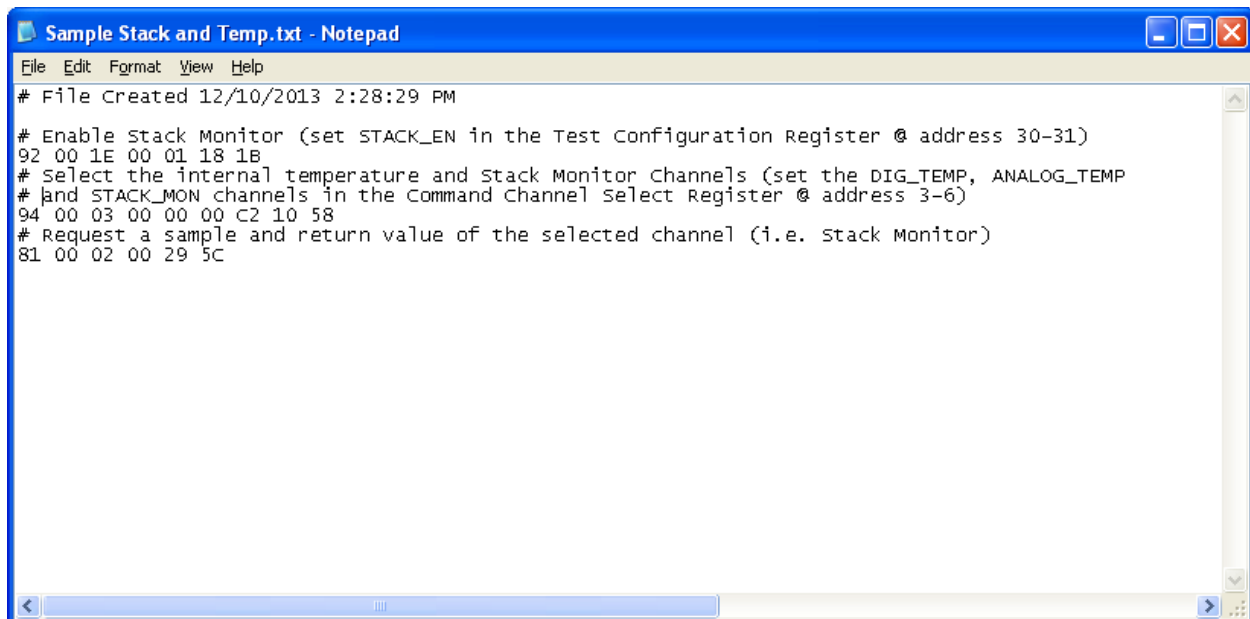

```

Sample Stack and Temp.txt - Notepad
File Edit Format View Help
# File Created 12/10/2013 2:28:29 PM

# Enable stack Monitor (set STACK_EN in the Test Configuration Register @ address 30-31)
92 00 1E 00 01 18 1B
# Select the internal temperature and stack Monitor Channels (set the DIG_TEMP, ANALOG_TEMP
# and STACK_MON channels in the Command Channel Select Register @ address 3-6)
94 00 03 00 00 00 C2 10 58
# Request a sample and return value of the selected channel (i.e. stack Monitor)
81 00 02 00 29 5C
    
```

Figure 40. Script with Comments

Although commands in scripts are processed sequentially, some inter-command delay occurs due to processing time, PC operating-system-introduced delays, and so forth. If additional inter-command delays are desired (for example, to allow a sampling process to complete before sending another command), then the scripting processor allows for the addition of inserted delays. The syntax for this additional delay is `DELAY time_in_milliseconds`. A sample of this inserted delay is seen in the example in [Figure 41](#).

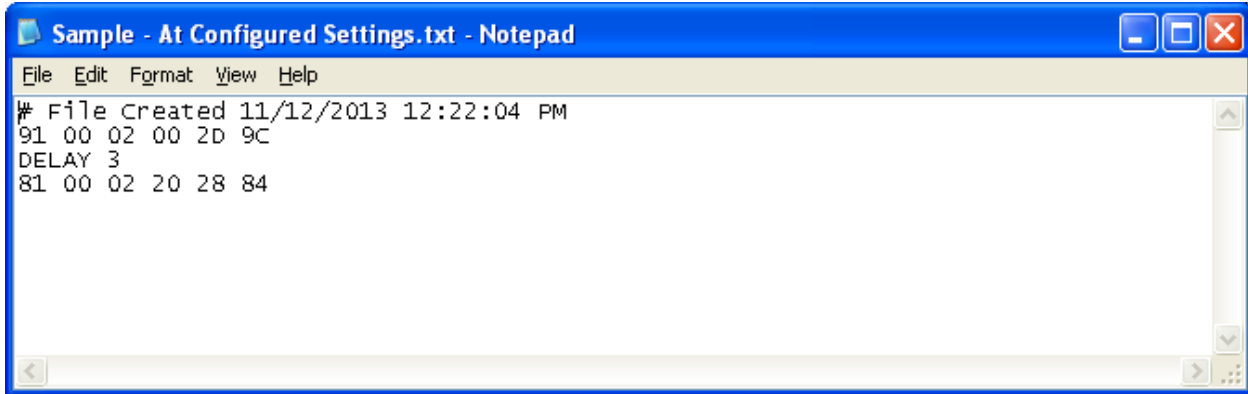

```

# File Created 11/12/2013 12:22:04 PM
91 00 02 00 2D 9C
DELAY 3
81 00 02 20 28 84
  
```

Figure 41. Example Script with Delay

7.16 Shutting Down

To shut down, first click the *Balance Off* button then click the *Poll Stop* button. The GUI goes into idle state. To exit the GUI, either click the *Exit* button in the lower right-hand corner of the GUI or click the 'X' window close box.

Remove the battery connections in reverse order to the sequence used during power up. (for example, remove BAT16S, BAT15 down through BAT1, BAT0S, and then BAT16 and BAT0).

Log Files

A.1 Log File Information

Each log file produced by the GUI contains information for a single evaluation module in the stack of bq76PL455EVMs connected to the host controller PC. This Appendix section provides detail and sample data for a log file produced by the GUI.

A log file produced by the GUI is in .tsv format. The name for this file may be chosen, or it can automatically be generated by the GUI. If the name user-created, provide a full path and name for the file. If the GUI automatically generates the file name, the format of the name is *TI_yymmdd_hhmmss.tsv*, and the file is stored in the default directory specified upon the initial GUI installation. The dynamic portions of the automatic GUI-generated file name have the following meanings:

- yy: last two digits of the year in which file was generated
- mm: two-digit month in which the file was generated
- dd: two-digit day of the month on which file was generated
- hh: hour, in 24-hour format, at which logging began
- mm: minute at which the logging began
- ss: second at which the logging began

In summary, each log file contains the board address (ID) of the bq76PL455EVM from which the data were collected, specific user *Notes* as entered in the available GUI field, the addresses and contents of a subset of the bq76PL455A-Q1 registers at the time data were collected, and the time-stamped data collected during a device polling session.

Each line entry of data collected from a selected bq76PL455EVM is date and time-stamped and contains data for all selected voltage, AUX, temperature and ancillary channels, as well as the content of the fault registers. Refer to the bq76PL455A-Q1 data sheet ([SLU5C51](#)) for an explanation of the meanings of the register data.

A.2 Sample bq76PL455EVM Log File

The following log file is a partial file example. The data section is shortened to save space and the tabs which normally appear in the file between each value have been substituted with commas for easier readability. Enough of each section of the file was kept in this example to provide an explanation of the file's content.

Comments regarding the file are in *red italic* type to distinguish these from actual file content. The file content is shown in its native text format (.tsv). Import the content of this file with spreadsheet software, such as Microsoft Excel, for easy viewing. Values in the sample below are not meant to be representative of recommended values and are provided as sample data only, demonstrating file structure.

GUI Version: 1.0.0.0	<i>The version of the GUI which generated this file.</i>
Board Address: 3	<i>Data in this file is from the bq76PL455EVM at address 3.</i>
Notes: This is a sample note.	<i>Any user-entered notes from the GUI appear here.</i>
Address Register Name Value (Hex)	<i>Column names (useful in spreadsheet view).</i>
3 Command Channel Select 0FFF0000	

NOTE: For multiple byte values, the start address stores the MSB of the value shown. For example, a 4-byte hex value of 03FFC000 shown for address 3 means address 3 = 03h, address 4 = FFh, address 5 = C0h, and address 6 = 00h.

7	Command Averaging	7B
10	Device Address	00
11	Group ID	00
12	Device Control	20
13	Number Channels	10
14	Device Configuration	10
15	Power Configuration	00
16	Communication Configuration	10C0
18	UART Transmitter Holdoff	00
19	Balance Configuration	00
20	Balancing Enable	0000
30	Test Configuration	0000
32	Test Control	0000
34	ADC Output Test	000000
37	AUX Pullup Test Control	00
40	Communication Timeout	00
41	Communication Timeout Counter	000000
50	Auto-Monitor Period	00
51	Auto-Monitor Channel Select	00000000
55	Auto-Monitor Averaging	00
60	ADC Mux Change Delay	00

61	Initial Sampling Delay	00
62	Voltage & Internal Temp Sampling Period	BC
63	AUX Sampling Period	44444444
67	Test Sampling Periods	F999
81	System Status	02
82	Fault Summary	0000
84	Cell Undervoltage Fault	0000
86	Cell Overvoltage Fault	0000
88	Auxiliary Under/Overthreshold Fault	0000
90	Comparator Undervoltage Fault	0000
92	Comparator Overvoltage Fault	0000
94	Communication Fault	0000
96	System Fault	00
97	Device Fault	0000
99	GPI Fault	00
104	Communication Fault Masks	0000
106	System Fault Masks	10
107	Device Fault Masks	0000
110	Fault Output Control	FFC0
120	General Purpose IO Direction	00
121	General Purpose Output	00
122	General Purpose Pullup	00
123	General Purpose Pulldown	3F
125	General Purpose Fault Input	00
140	Comparator Undervoltage Threshold	18
141	Comparator Overvoltage Threshold	C8
142	Cell Undervoltage Threshold	2E14
144	Cell Overvoltage Threshold	EB84
146	AUX0 Undervoltage Threshold	0000
148	AUX0 Overvoltage Threshold	FFFC
150	AUX1 Undervoltage Threshold	0000
152	AUX1 Overvoltage Threshold	FFFC
154	AUX2 Undervoltage Threshold	0000
156	AUX2 Overvoltage Threshold	FFFC
158	AUX3 Undervoltage Threshold	0000
160	AUX3 Overvoltage Threshold	FFFC
162	AUX4 Undervoltage Threshold	0000
164	AUX4 Overvoltage Threshold	FFFC
166	AUX5 Undervoltage Threshold	0000
168	AUX5 Overvoltage Threshold	FFFC
170	AUX6 Undervoltage Threshold	0000
172	AUX6 Overvoltage Threshold	FFFC
174	AUX7 Undervoltage Threshold	0000
176	AUX7 Overvoltage Threshold	FFFC
200	Customer Scratchpad	00000000000000 00
210	Customer Cell Offset	00

211	Customer Gain Offset	00
212	Customer AUX0 Offset	0000
214	Customer AUX1 Offset	0000
216	Customer AUX2 Offset	0000
218	Customer AUX3 Offset	0000
220	Customer AUX4 Offset	0000
222	Customer AUX5 Offset	0000
224	Customer AUX6 Offset	0000
226	Customer AUX7 Offset	0000
240	Customer Checksum	EE5E38D8
250	EEPROM Burn Count	01

Board Address: 3 *Module address shown again for easier viewing immediately before logged data*

Time, Elapsed Time (Sec), BalanceEnable, Cell_1, Cell_2, Cell_3, Cell_4, Cell_5, Cell_6, Cell_7, Cell_8, Cell_9, Cell_10, Cell_11, Cell_12, Cell_13, Cell_14, Cell_15, Cell_16, AUX_1, AUX_2, AUX_3, AUX_4, AUX_5, AUX_6, AUX_7, AUX_8, Int Dig Temp, Int Anlg Temp, FSummary, CUVF, COVF, AuxuovThresF, CUVF, COVF, CommF, SystemF, DeviceF, GPIF

The column names are useful when data is viewed with spreadsheet software; spaces are added after each comma or tab to aid readability. These spaces are not present in the actual log file and all commas are tabs in the .tsv file. The "BalanceEnable" column only contains data when balancing is enabled and turned on. The data in such a case is the value of the Balancing Enable register at addresses 20 and 21 (see the bq76PL455A-Q1 data sheet ([SLUSC51](#)) for additional information regarding this register). The same comment applies to the four data samples below. The content of the fault registers is recorded under the FSummary and xxxF headings. Fault data are presented in the form: register_address: register_value_in_hex. For example, 82:0000 means the register at address 82 (that is, the Fault Summary register), contains a value of 0000 hex. Consult the data sheet for more details on the various fault registers referred to by address in the log file; bit definitions for the various fault registers are detailed in the register descriptions in the data sheet.

12/31/2013 5:26:39 PM, 0.499000, , 3.112211, 3.349493, 3.548345, 3.794567, 3.023567, 3.219912, 3.504123, 3.697098, 3.890456, 3.099765, 3.333789, 3.554325, 3.745012, 3.991543, 4.176456, 3.454876, 1.188246, 1.439135, 1.934864, 1.856086, 1.881975, 1.814135, 1.715864, 1.302648, 0.0000, 0.0000, 82:0000, 84:0000, 86:0000, 88:0000, 90:0000, 92:0000, 94:0000, 96:00, 97:0000, 99:00

Internal temperature is not being logged in this example. "3814" in the intervals at 0.999000 seconds and 1.499000 seconds indicate that cells 3, 5, 12, 13 and 14 were being actively balanced. "3814" is a hexadecimal representation of the binary value 0011 1000 0001 0100. Each '1' bit represents a cell being balanced, each '0' bit represents a cell not being balanced. (Refer to the description of the Balancing Enable register in the bq76PL455A-Q1 data sheet ([SLUSC51](#)) for additional information.)

12/31/2013 5:26:39 PM, 0.999000, 3814, 3.116230, 3.347999, 3.550401, 3.795432, 3.022998, 3.222023, 3.502967, 3.698901, 3.891953, 3.098876, 3.333893, 3.553979, 3.748014, 3.988978, 4.177001, 3.454023, 1.423829, 1.089947, 1.666958, 1.632123, 1.645456, 1.600789, 1.503890, 1.269901, 0.0000, 0.0000, 82:0000, 84:0000, 86:0000, 88:0000, 90:0000, 92:0000, 94:0000, 96:00, 97:0000, 99:00

12/31/2013 5:26:40 PM, 1.499000, 3814, , 3.116233, 3.347970, 3.550395, 3.795398, 3.022945, 3.221096, 3.503012, 3.698845, 3.892021, 3.099121, 3.334031, 3.553989, 3.748012, 3.990021, 4.174011, 3.454012, 1.929034, 1.857302, 1.493123, 1.479234, 1.510345, 1.471456, 1.399567, 1.267678, 0.0000, 0.0000, 82:0000, 84:0000, 86:0000, 88:0000, 90:0000, 92:0000, 94:0000, 96:00, 97:0000, 99:00

12/31/2013 5:26:40 PM, 1.999000, , 3.112221, 3.350678, 3.549369, 3.795402, 3.024783, 3.218998, 3.504001, 3.699001, 3.892025, 3.100002, 3.333794, 3.556005, 3.747987, 3.991100, 4.176022, 3.452017, 1.571526, 1.687453, 1.393345, 1.390234, 1.427456, 1.394432, 1.343345, 1.268543, 0.0000, 0.0000, 82:0000, 84:0000, 86:0000, 88:0000, 90:0000, 92:0000, 94:0000, 96:00, 97:0000, 99:00

NOTE: When logging data for all the bq76PL455EVMs, the specified target file name for the collected data is appended with an underscore and the bq76PL455EVM address of the evaluation module from which the data were collected.

NOTE: From time to time, log file formats and other GUI features are adjusted slightly to add new features. Although every effort is made to update this document appropriately when such changes are made, there may be some mismatch between this document and the version of GUI being used.

Bill of Materials

Designator	Quantity	Value	Description	Package Reference	Part Number	Manufacturer
BAT0, BAT16, CHP, COMMH+, COMMH-, COMML+, COMML-, FLT-N, FLTH+, FLTH-, FLTL+, FLTL-, RX, S0, S1, S2, S3, S4, S5, S6, S7, S8, S9, S10, S11, S12, S13, S14, S15, S16, TOP, TX, V5VA0, VDIG, VIO, VM, VP1, VREF, WAKEUP	39	White	Test Point, Miniature, White, TH	White Miniature Testpoint	5002	Keystone
C17, C18	2	1uF	CAP, CERM, 1uF, 16V, +/-10%, X7R, 0603	603	C1608X7R1C105K	TDK
C19, C29, C31, C32, C34, C35, C37, C38	8	0.1uF	CAP, CERM, 0.1uF, 50V, +/-10%, X7R, 0603	603	C1608X7R1H104K	TDK
C20, C21, C22, C23, C24, C25, C26, C27	8	1000pF	CAP, CERM, 1000pF, 1000V, +/-10%, X7R, 1206	1206	CC1206KKX7RCBB102	Yageo America
C28, C41, C66	3	4.7uF	CAP, CERM, 4.7uF, 16V, +/-10%, X7R, 0805	805	GRM21BR71C475KA73L	MuRata
C30, C43, C46, C47, C48, C49, C50, C51, C52, C53, C54, C55, C56, C57, C58, C61	16	1uF	CAP, CERM, 1uF, 100V, +/-10%, X7R, 1210	1210	GRM32CR72A105KA35L	MuRata
C33	1	0.1uF	CAP, CERM, 0.1uF, 100V, +/-10%, X7R, 1210	1210	GRM32NR72A104KA01L	MuRata
C36	1	4.7uF	CAP, CERM, 4.7uF, 50V, +/-10%, X7R, 1206	1206	GRM31CR71H475KA12L	MuRata
C39, C59, C62, C63, C64	5	0.1uF	CAP, CERM, 0.1uF, 25V, +/-10%, X7R, 0603	603	C0603X104K3RACTU	Kemet
C40	1	1uF	CAP, CERM, 1uF, 100V, +/-10%, X7R, 1206	1206	GRM31CR72A105KA01L	MuRata
C42	1	0.022uF	CAP, CERM, 0.022uF, 50V, +/-10%, X7R, 0603	603	C1608X7R1H223K	TDK
C45, C67	2	0.1uF	CAP, CERM, 0.1uF, 16V, +/-10%, X7R, 0603	603	GRM188R71C104KA01D	MuRata
C60	1	1.8uF	CAP, CERM, 1.8uF, 25V, +/-10%, X7R, 1210	1210	C1210C185K3RACTU	Kemet
C68	1	2700pF	CAP, CERM, 2700pF, 50V, +/-5%, COG/NP0, 0805	805	08055A272JAT2A	AVX
C69	1	1200pF	CAP, CERM, 1200pF, 50V, +/-5%, COG/NP0, 0805	805	08055A122JAT2A	AVX
C70	1	560pF	CAP, CERM, 560pF, 50V, +/-5%, COG/NP0, 0805	805	08055A561JAT2A	AVX
C71	1	390pF	CAP, CERM, 390pF, 50V, +/-5%, COG/NP0, 0805	805	08055A391JAT2A	AVX
D1, D2, D3, D4, D5, D6, D7, D8, D9, D10, D11, D12, D13, D14, D15, D16, D22	17	Green	LED 570NM GREEN DIFF 1206 SMD	1206	HSMG-C150	Avago Technologies

Designator	Quantity	Value	Description	Package Reference	Part Number	Manufacturer
D17, D18, D20, D21	4	100V	Diode, Ultrafast, 100V, 0.15A, SOD-123	SOD-123	1N4148W-7-F	Diodes Inc.
D19	1	40V	Diode, Schottky, 40V, 1A, SOD-123	SOD-123	1N5819HW-7-F	Diodes Inc.
GND	1	Triple	Terminal, Turret, TH, Triple	Keystone1598-2	1598-2	Keystone
H1, H2, H3, H4	4		Machine Screw, Round, #4-40 x 1/4, Nylon, Philips panhead	Screw	NY PMS 440 0025 PH	B&F Fastener Supply
H5, H6, H7, H8	4		Standoff, Hex, 0.5"L #4-40 Nylon	Standoff	1902C	Keystone
J1	1		2.54mm Pitch SL Crimp Housing, Single Row, 22 Circuits	70555-0056	70555-0056	Molex
J2	1		MOLEX CONN RECEPT 16POS 3MM VERT DUAL	43045-1601	43045-1601	Molex
J3	1		Right Angle Header, TH, 100mil, 6x1	22-12-4062	22-12-4062	Molex
J4, J5	2		Right Angle Header, TH, 100mil, 4x1, 15u Gold Plate	70551-0038	70551-0038	Molex
OUT	1	SMT	Test Point, Miniature, SMT	Testpoint_Keystone_Miniature	5015	Keystone
P1	1		Header, TH, 100mil, 7x2, Gold plated, 230 mil above insulator	7x2 Header	TSW-107-07-G-D	Samtec, Inc.
Q1, Q2, Q3, Q4, Q5, Q6, Q7, Q8, Q9, Q10, Q11, Q12, Q13, Q14, Q15, Q16	16	60V	MOSFET, N-CH, 60V, 0.38A, SOT-23	SOT-23	2V7002KT1G	ON Semiconductor
Q17	1		TRANS 150V 1A NPN LED DRVR TO252	DPAK	ZXTN4004KTC	Diodes/Zetex
Q18	1	-40V	MOSFET, P-CH, -40V, -2.3A, SOT-23	SOT-23	SI2319DS-T1-E3	Vishay-Siliconix
Q19	1	60V	MOSFET, N-CH, 60V, 0.24A, SOT-23	SOT-23	2N7002E-T1-E3	Vishay-Siliconix
R1, R2, R3, R4, R5, R6, R7, R8, R9, R10, R11, R12, R13, R14, R15, R16	16	75	RES 75 OHM 1W 1% 2512 SMD	2512	CRCW251275R0FKKEG	Vishay/Dale
R17, R50, R53, R56, R63, R66, R68, R70, R72	9	10.0k	RES, 10.0k ohm, 1%, 0.1W, 0603	603	CRCW060310K0FKEA	Vishay-Dale
R18, R21, R22, R23, R24, R77, R82, R85, R90, R93, R98, R101, R106, R109, R114, R117, R122, R125, R130, R133, R137	21	100k	RES, 100k ohm, 1%, 0.1W, 0603	603	RC0603FR-07100KL	Yageo America
R19	1	49.9k	RES, 49.9k ohm, 1%, 0.1W, 0603	603	RC0603FR-0749K9L	Yageo America
R20	1	100	RES, 100 ohm, 1%, 0.25W, 1206	1206	CRCW1206100RFKEA	Vishay-Dale
R25, R26, R27, R28, R29, R30, R31, R32	8	10	RES, 10.0 ohm, 1%, 0.25W, 1206	1206	CRCW120610R0FKEA	Vishay-Dale
R33, R35, R36, R37	4	49.9	RES, 49.9 ohm, 1%, 0.1W, 0603	603	CRCW060349R9FKEA	Vishay-Dale
R34	1	100	RES, 100 ohm, 1%, 0.1W, 0603	603	CRCW0603100RFKEA	Vishay-Dale
R51, R55, R58, R65, R67, R69, R71, R73	8	10	RES, 10.0 ohm, 1%, 0.1W, 0603	603	CRCW060310R0FKEA	Vishay-Dale
R52, R54	2	200	RES 200 OHM 1W 5% 2512 SMD	2512	CRCW2512200RJNEG	Vishay/Dale
R57, R59	2	0	RES, 0 ohm, 5%, 0.1W, 0603	603	CRCW06030000Z0EA	Vishay-Dale

Designator	Quantity	Value	Description	Package Reference	Part Number	Manufacturer
R60, R76, R81, R83, R89, R91, R97, R99, R105, R107, R113, R115, R121, R123, R129, R131, R136	17	2.00k	RES, 2.00k ohm, 1%, 0.1W, 0603	603	CRCW06032K00FKEA	Vishay-Dale
R61, R62	2	1	RES, 1.00 ohm, 1%, 0.1W, 0603	603	RC0603FR-071RL	Yageo America
R64	1	0.39	RES, 0.39 ohm, 1%, 0.1W, 0603	603	ERJ-3RQFR39V	Panasonic
R74, R75, R78, R79, R80, R84, R86, R87, R88, R92, R94, R95, R96, R100, R102, R103, R104, R108, R110, R111, R112, R116, R118, R119, R120, R124, R126, R127, R128, R132, R134,	33	1.00k	RES, 1.00k ohm, 1%, 0.1W, 0603	603	CRCW06031K00FKEA	Vishay-Dale
R135, R138						
SW1	1		SWITCH DIP 4-POS SLIDE SMD	CHS-04TA	CHS-04TA	Copal
SW2	1		SWITCH DIP DPDT 1POS SMT		204-221ST	CTS Electrocomponents
T1, T2, T3, T4	4		CHOKE COMMON MODE 2200 OHM .4A	744242xxx	744242471	Würth
T5, T6, T7, T8	4		CHOKE COMMON MODE 5800 OHM .15A	ACT45B	ACT45B-101-2P	TDK
U1	1		16 Cell Battery Stack Monitor with Passive Cell Balancing	VHB80A	bq76PL455TPFCQ1	Texas Instruments
U2	1		UHS Inverter 2.4ns into 50pF at 5V	SOT23-5	NC7SZ04M5X	Fairchild
Z1, Z2, Z3, Z4, Z5, Z6, Z7, Z8, Z9, Z10, Z11, Z12, Z13, Z14, Z15, Z16	16	6.2V	DIODE ZENER 6.2V 500MW SOD-123	SOD-123	DDZ6V2B-7	Diodes Inc
Z19	1		DIODE TVS 90V 400W UNI 5% SMA	SMA	SMAJ90A	Littlefue Inc
Z20, Z21, Z22, Z23, Z24, Z25, Z26, Z27	8		DIODE ESD PROT UNI 5V SOD323-2	SOD-323	PESD5V0U1UA,115	NXP
ZZ1	1		USB Serial Cable		TTL-232R-5V	FTDI
C1, C2, C3, C4, C5, C6, C7, C8, C9, C10, C11, C12, C13, C14, C15, C16	0	1uF	CAP, CERM, 1uF, 16V, +/-10%, X7R, 0603	603	C1608X7R1C105K	TDK
C44	0	4700pF	CAP, CERM, 4700pF, 25V, +/-5%, C0G/NP0, 0805	805	08053A472JAT2A	AVX
R38, R39, R40, R41, R42, R43, R44, R45	0	0	RES, 0 ohm, 5%, 0.1W, 0603	603	CRCW06030000Z0EA	Vishay-Dale

Schematics

Figure 42 shows the bq76PL455EVM schematic.

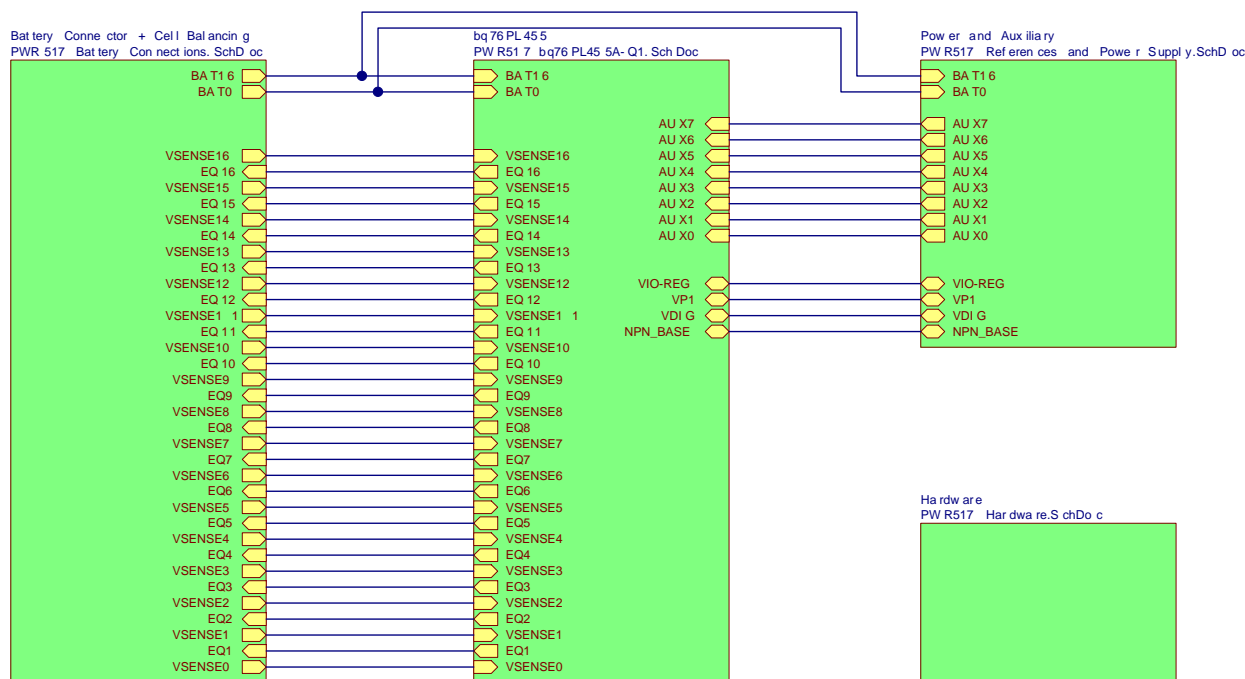

Figure 42. bq76PL455EVM Schematic - Sheet 1

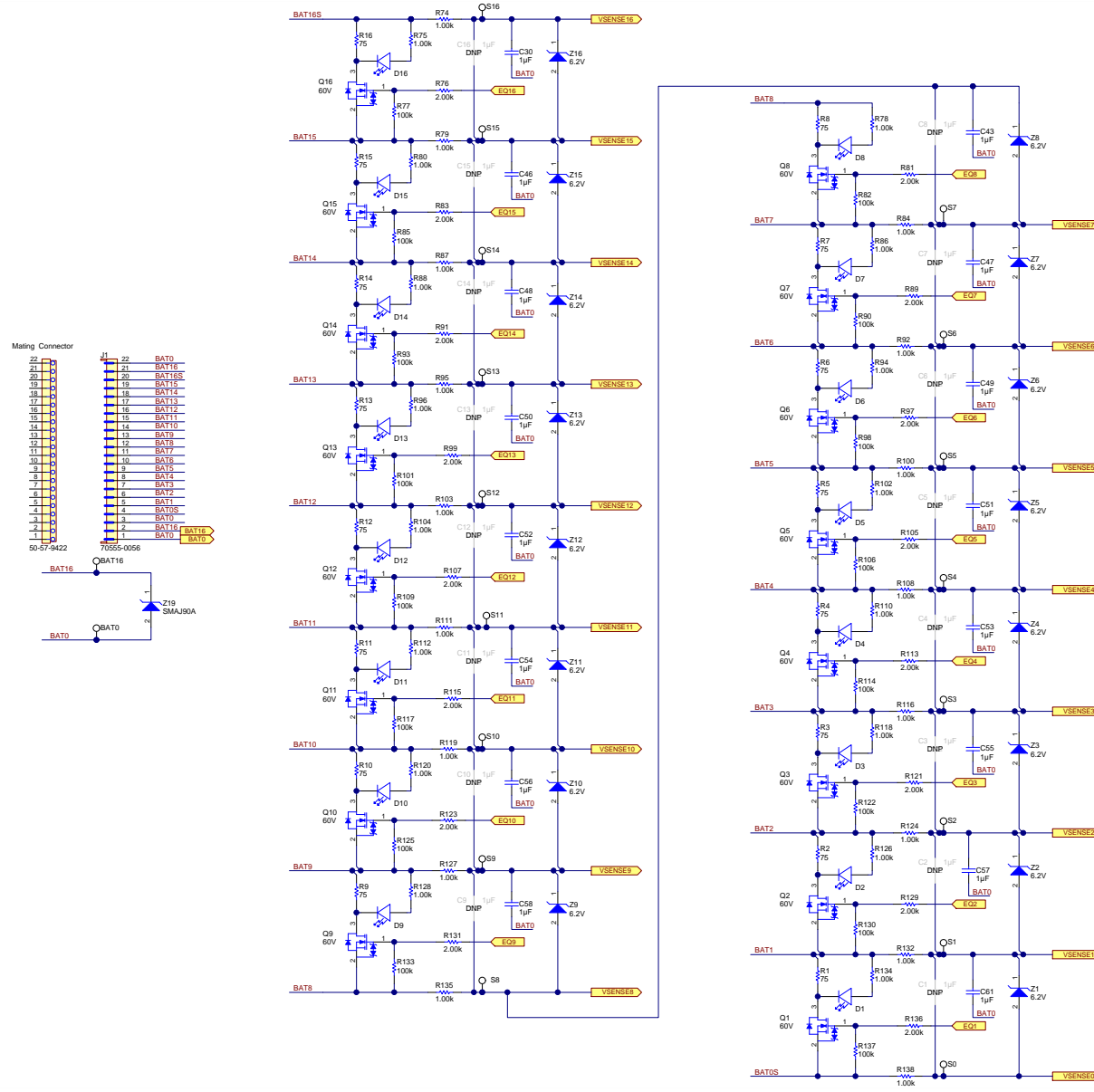

Figure 43. bq76PL455EVM Schematic - Sheet 2

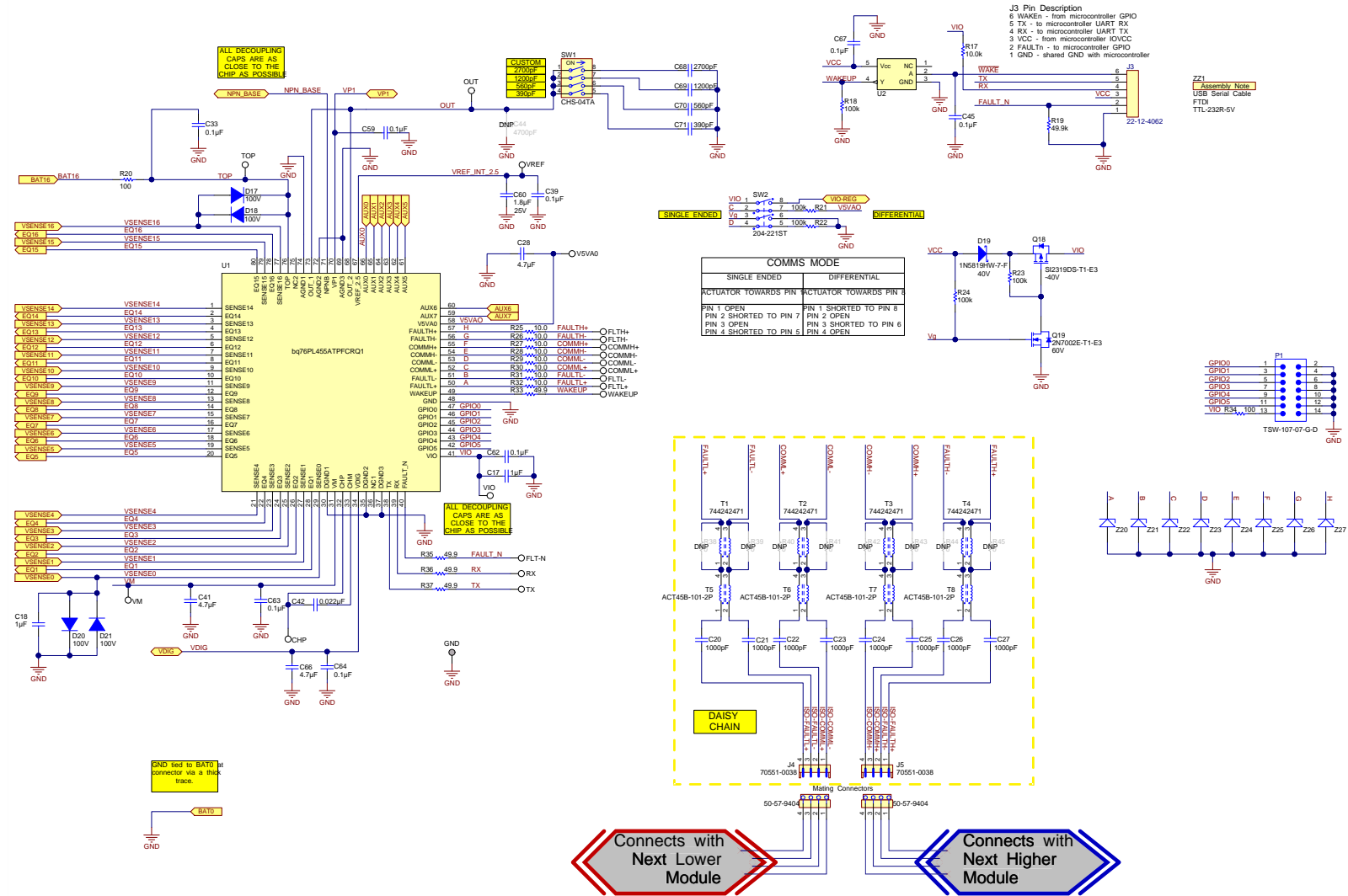

Figure 44. bq76PL455EVM Schematic - Sheet 3

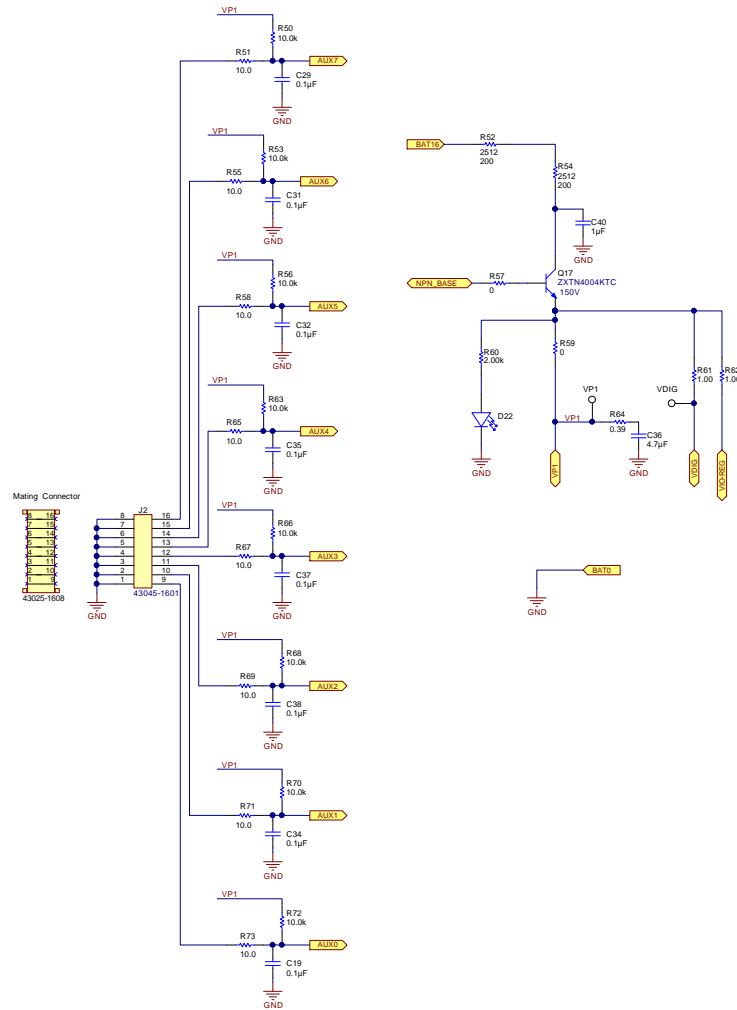

Figure 45. bq76PL455EVM Schematic - Sheet 4

Revision History

Changes from Original (April 2015) to A Revision	Page
• Added appendix title	53
• Added Appendix B: Bill of Materials	58
• Added Appendix C: Schematics	61

STANDARD TERMS AND CONDITIONS FOR EVALUATION MODULES

1. *Delivery:* TI delivers TI evaluation boards, kits, or modules, including any accompanying demonstration software, components, or documentation (collectively, an "EVM" or "EVMs") to the User ("User") in accordance with the terms and conditions set forth herein. Acceptance of the EVM is expressly subject to the following terms and conditions.
 - 1.1 EVMs are intended solely for product or software developers for use in a research and development setting to facilitate feasibility evaluation, experimentation, or scientific analysis of TI semiconductors products. EVMs have no direct function and are not finished products. EVMs shall not be directly or indirectly assembled as a part or subassembly in any finished product. For clarification, any software or software tools provided with the EVM ("Software") shall not be subject to the terms and conditions set forth herein but rather shall be subject to the applicable terms and conditions that accompany such Software
 - 1.2 EVMs are not intended for consumer or household use. EVMs may not be sold, sublicensed, leased, rented, loaned, assigned, or otherwise distributed for commercial purposes by Users, in whole or in part, or used in any finished product or production system.
2. *Limited Warranty and Related Remedies/Disclaimers:*
 - 2.1 These terms and conditions do not apply to Software. The warranty, if any, for Software is covered in the applicable Software License Agreement.
 - 2.2 TI warrants that the TI EVM will conform to TI's published specifications for ninety (90) days after the date TI delivers such EVM to User. Notwithstanding the foregoing, TI shall not be liable for any defects that are caused by neglect, misuse or mistreatment by an entity other than TI, including improper installation or testing, or for any EVMs that have been altered or modified in any way by an entity other than TI. Moreover, TI shall not be liable for any defects that result from User's design, specifications or instructions for such EVMs. Testing and other quality control techniques are used to the extent TI deems necessary or as mandated by government requirements. TI does not test all parameters of each EVM.
 - 2.3 If any EVM fails to conform to the warranty set forth above, TI's sole liability shall be at its option to repair or replace such EVM, or credit User's account for such EVM. TI's liability under this warranty shall be limited to EVMs that are returned during the warranty period to the address designated by TI and that are determined by TI not to conform to such warranty. If TI elects to repair or replace such EVM, TI shall have a reasonable time to repair such EVM or provide replacements. Repaired EVMs shall be warranted for the remainder of the original warranty period. Replaced EVMs shall be warranted for a new full ninety (90) day warranty period.
3. *Regulatory Notices:*
 - 3.1 *United States*
 - 3.1.1 *Notice applicable to EVMs not FCC-Approved:*

This kit is designed to allow product developers to evaluate electronic components, circuitry, or software associated with the kit to determine whether to incorporate such items in a finished product and software developers to write software applications for use with the end product. This kit is not a finished product and when assembled may not be resold or otherwise marketed unless all required FCC equipment authorizations are first obtained. Operation is subject to the condition that this product not cause harmful interference to licensed radio stations and that this product accept harmful interference. Unless the assembled kit is designed to operate under part 15, part 18 or part 95 of this chapter, the operator of the kit must operate under the authority of an FCC license holder or must secure an experimental authorization under part 5 of this chapter.
 - 3.1.2 *For EVMs annotated as FCC – FEDERAL COMMUNICATIONS COMMISSION Part 15 Compliant:*

CAUTION

This device complies with part 15 of the FCC Rules. Operation is subject to the following two conditions: (1) This device may not cause harmful interference, and (2) this device must accept any interference received, including interference that may cause undesired operation.

Changes or modifications not expressly approved by the party responsible for compliance could void the user's authority to operate the equipment.

FCC Interference Statement for Class A EVM devices

NOTE: This equipment has been tested and found to comply with the limits for a Class A digital device, pursuant to part 15 of the FCC Rules. These limits are designed to provide reasonable protection against harmful interference when the equipment is operated in a commercial environment. This equipment generates, uses, and can radiate radio frequency energy and, if not installed and used in accordance with the instruction manual, may cause harmful interference to radio communications. Operation of this equipment in a residential area is likely to cause harmful interference in which case the user will be required to correct the interference at his own expense.

FCC Interference Statement for Class B EVM devices

NOTE: This equipment has been tested and found to comply with the limits for a Class B digital device, pursuant to part 15 of the FCC Rules. These limits are designed to provide reasonable protection against harmful interference in a residential installation. This equipment generates, uses and can radiate radio frequency energy and, if not installed and used in accordance with the instructions, may cause harmful interference to radio communications. However, there is no guarantee that interference will not occur in a particular installation. If this equipment does cause harmful interference to radio or television reception, which can be determined by turning the equipment off and on, the user is encouraged to try to correct the interference by one or more of the following measures:

- Reorient or relocate the receiving antenna.
- Increase the separation between the equipment and receiver.
- Connect the equipment into an outlet on a circuit different from that to which the receiver is connected.
- Consult the dealer or an experienced radio/TV technician for help.

3.2 Canada

3.2.1 For EVMs issued with an Industry Canada Certificate of Conformance to RSS-210

Concerning EVMs Including Radio Transmitters:

This device complies with Industry Canada license-exempt RSS standard(s). Operation is subject to the following two conditions: (1) this device may not cause interference, and (2) this device must accept any interference, including interference that may cause undesired operation of the device.

Concernant les EVMs avec appareils radio:

Le présent appareil est conforme aux CNR d'Industrie Canada applicables aux appareils radio exempts de licence. L'exploitation est autorisée aux deux conditions suivantes: (1) l'appareil ne doit pas produire de brouillage, et (2) l'utilisateur de l'appareil doit accepter tout brouillage radioélectrique subi, même si le brouillage est susceptible d'en compromettre le fonctionnement.

Concerning EVMs Including Detachable Antennas:

Under Industry Canada regulations, this radio transmitter may only operate using an antenna of a type and maximum (or lesser) gain approved for the transmitter by Industry Canada. To reduce potential radio interference to other users, the antenna type and its gain should be so chosen that the equivalent isotropically radiated power (e.i.r.p.) is not more than that necessary for successful communication. This radio transmitter has been approved by Industry Canada to operate with the antenna types listed in the user guide with the maximum permissible gain and required antenna impedance for each antenna type indicated. Antenna types not included in this list, having a gain greater than the maximum gain indicated for that type, are strictly prohibited for use with this device.

Concernant les EVMs avec antennes détachables

Conformément à la réglementation d'Industrie Canada, le présent émetteur radio peut fonctionner avec une antenne d'un type et d'un gain maximal (ou inférieur) approuvé pour l'émetteur par Industrie Canada. Dans le but de réduire les risques de brouillage radioélectrique à l'intention des autres utilisateurs, il faut choisir le type d'antenne et son gain de sorte que la puissance isotrope rayonnée équivalente (p.i.r.e.) ne dépasse pas l'intensité nécessaire à l'établissement d'une communication satisfaisante. Le présent émetteur radio a été approuvé par Industrie Canada pour fonctionner avec les types d'antenne énumérés dans le manuel d'usage et ayant un gain admissible maximal et l'impédance requise pour chaque type d'antenne. Les types d'antenne non inclus dans cette liste, ou dont le gain est supérieur au gain maximal indiqué, sont strictement interdits pour l'exploitation de l'émetteur.

3.3 Japan

3.3.1 *Notice for EVMs delivered in Japan:* Please see http://www.tij.co.jp/lstds/ti_ja/general/eStore/notice_01.page 日本国内に輸入される評価用キット、ボードについては、次のところをご覧ください。
http://www.tij.co.jp/lstds/ti_ja/general/eStore/notice_01.page

3.3.2 *Notice for Users of EVMs Considered "Radio Frequency Products" in Japan:* EVMs entering Japan may not be certified by TI as conforming to Technical Regulations of Radio Law of Japan.

If User uses EVMs in Japan, not certified to Technical Regulations of Radio Law of Japan, User is required by Radio Law of Japan to follow the instructions below with respect to EVMs:

1. Use EVMs in a shielded room or any other test facility as defined in the notification #173 issued by Ministry of Internal Affairs and Communications on March 28, 2006, based on Sub-section 1.1 of Article 6 of the Ministry's Rule for Enforcement of Radio Law of Japan,
2. Use EVMs only after User obtains the license of Test Radio Station as provided in Radio Law of Japan with respect to EVMs, or
3. Use of EVMs only after User obtains the Technical Regulations Conformity Certification as provided in Radio Law of Japan with respect to EVMs. Also, do not transfer EVMs, unless User gives the same notice above to the transferee. Please note that if User does not follow the instructions above, User will be subject to penalties of Radio Law of Japan.

【無線電波を送信する製品の開発キットをお使いになる際の注意事項】 開発キットの中には技術基準適合証明を受けていないものがあります。技術適合証明を受けていないものご使用に際しては、電波法遵守のため、以下のいずれかの措置を取っていただく必要がありますのでご注意ください。

1. 電波法施行規則第6条第1項第1号に基づく平成18年3月28日総務省告示第173号で定められた電波暗室等の試験設備でご使用いただく。
2. 実験局の免許を取得後ご使用いただく。
3. 技術基準適合証明を取得後ご使用いただく。

なお、本製品は、上記の「ご使用にあたっての注意」を譲渡先、移転先に通知しない限り、譲渡、移転できないものとします。

上記を遵守頂けない場合は、電波法の罰則が適用される可能性があることをご留意ください。日本テキサス・インスツルメンツ株式会社
東京都新宿区西新宿 6 丁目 2 4 番 1 号
西新宿三井ビル

3.3.3 *Notice for EVMs for Power Line Communication:* Please see http://www.tij.co.jp/lstds/ti_ja/general/eStore/notice_02.page
電力線搬送波通信についての開発キットをお使いになる際の注意事項については、次のところをご覧ください。 http://www.tij.co.jp/lstds/ti_ja/general/eStore/notice_02.page

4 *EVM Use Restrictions and Warnings:*

4.1 EVMS ARE NOT FOR USE IN FUNCTIONAL SAFETY AND/OR SAFETY CRITICAL EVALUATIONS, INCLUDING BUT NOT LIMITED TO EVALUATIONS OF LIFE SUPPORT APPLICATIONS.

4.2 User must read and apply the user guide and other available documentation provided by TI regarding the EVM prior to handling or using the EVM, including without limitation any warning or restriction notices. The notices contain important safety information related to, for example, temperatures and voltages.

4.3 *Safety-Related Warnings and Restrictions:*

4.3.1 User shall operate the EVM within TI's recommended specifications and environmental considerations stated in the user guide, other available documentation provided by TI, and any other applicable requirements and employ reasonable and customary safeguards. Exceeding the specified performance ratings and specifications (including but not limited to input and output voltage, current, power, and environmental ranges) for the EVM may cause personal injury or death, or property damage. If there are questions concerning performance ratings and specifications, User should contact a TI field representative prior to connecting interface electronics including input power and intended loads. Any loads applied outside of the specified output range may also result in unintended and/or inaccurate operation and/or possible permanent damage to the EVM and/or interface electronics. Please consult the EVM user guide prior to connecting any load to the EVM output. If there is uncertainty as to the load specification, please contact a TI field representative. During normal operation, even with the inputs and outputs kept within the specified allowable ranges, some circuit components may have elevated case temperatures. These components include but are not limited to linear regulators, switching transistors, pass transistors, current sense resistors, and heat sinks, which can be identified using the information in the associated documentation. When working with the EVM, please be aware that the EVM may become very warm.

4.3.2 EVMs are intended solely for use by technically qualified, professional electronics experts who are familiar with the dangers and application risks associated with handling electrical mechanical components, systems, and subsystems. User assumes all responsibility and liability for proper and safe handling and use of the EVM by User or its employees, affiliates, contractors or designees. User assumes all responsibility and liability to ensure that any interfaces (electronic and/or mechanical) between the EVM and any human body are designed with suitable isolation and means to safely limit accessible leakage currents to minimize the risk of electrical shock hazard. User assumes all responsibility and liability for any improper or unsafe handling or use of the EVM by User or its employees, affiliates, contractors or designees.

4.4 User assumes all responsibility and liability to determine whether the EVM is subject to any applicable international, federal, state, or local laws and regulations related to User's handling and use of the EVM and, if applicable, User assumes all responsibility and liability for compliance in all respects with such laws and regulations. User assumes all responsibility and liability for proper disposal and recycling of the EVM consistent with all applicable international, federal, state, and local requirements.

5. *Accuracy of Information:* To the extent TI provides information on the availability and function of EVMs, TI attempts to be as accurate as possible. However, TI does not warrant the accuracy of EVM descriptions, EVM availability or other information on its websites as accurate, complete, reliable, current, or error-free.

6. *Disclaimers:*
- 6.1 EXCEPT AS SET FORTH ABOVE, EVMS AND ANY WRITTEN DESIGN MATERIALS PROVIDED WITH THE EVM (AND THE DESIGN OF THE EVM ITSELF) ARE PROVIDED "AS IS" AND "WITH ALL FAULTS." TI DISCLAIMS ALL OTHER WARRANTIES, EXPRESS OR IMPLIED, REGARDING SUCH ITEMS, INCLUDING BUT NOT LIMITED TO ANY IMPLIED WARRANTIES OF MERCHANTABILITY OR FITNESS FOR A PARTICULAR PURPOSE OR NON-INFRINGEMENT OF ANY THIRD PARTY PATENTS, COPYRIGHTS, TRADE SECRETS OR OTHER INTELLECTUAL PROPERTY RIGHTS.
- 6.2 EXCEPT FOR THE LIMITED RIGHT TO USE THE EVM SET FORTH HEREIN, NOTHING IN THESE TERMS AND CONDITIONS SHALL BE CONSTRUED AS GRANTING OR CONFERRING ANY RIGHTS BY LICENSE, PATENT, OR ANY OTHER INDUSTRIAL OR INTELLECTUAL PROPERTY RIGHT OF TI, ITS SUPPLIERS/LICENSORS OR ANY OTHER THIRD PARTY, TO USE THE EVM IN ANY FINISHED END-USER OR READY-TO-USE FINAL PRODUCT, OR FOR ANY INVENTION, DISCOVERY OR IMPROVEMENT MADE, CONCEIVED OR ACQUIRED PRIOR TO OR AFTER DELIVERY OF THE EVM.
7. *USER'S INDEMNITY OBLIGATIONS AND REPRESENTATIONS.* USER WILL DEFEND, INDEMNIFY AND HOLD TI, ITS LICENSORS AND THEIR REPRESENTATIVES HARMLESS FROM AND AGAINST ANY AND ALL CLAIMS, DAMAGES, LOSSES, EXPENSES, COSTS AND LIABILITIES (COLLECTIVELY, "CLAIMS") ARISING OUT OF OR IN CONNECTION WITH ANY HANDLING OR USE OF THE EVM THAT IS NOT IN ACCORDANCE WITH THESE TERMS AND CONDITIONS. THIS OBLIGATION SHALL APPLY WHETHER CLAIMS ARISE UNDER STATUTE, REGULATION, OR THE LAW OF TORT, CONTRACT OR ANY OTHER LEGAL THEORY, AND EVEN IF THE EVM FAILS TO PERFORM AS DESCRIBED OR EXPECTED.
8. *Limitations on Damages and Liability:*
- 8.1 *General Limitations.* IN NO EVENT SHALL TI BE LIABLE FOR ANY SPECIAL, COLLATERAL, INDIRECT, PUNITIVE, INCIDENTAL, CONSEQUENTIAL, OR EXEMPLARY DAMAGES IN CONNECTION WITH OR ARISING OUT OF THESE TERMS AND CONDITIONS OR THE USE OF THE EVMS PROVIDED HEREUNDER, REGARDLESS OF WHETHER TI HAS BEEN ADVISED OF THE POSSIBILITY OF SUCH DAMAGES. EXCLUDED DAMAGES INCLUDE, BUT ARE NOT LIMITED TO, COST OF REMOVAL OR REINSTALLATION, ANCILLARY COSTS TO THE PROCUREMENT OF SUBSTITUTE GOODS OR SERVICES, RETESTING, OUTSIDE COMPUTER TIME, LABOR COSTS, LOSS OF GOODWILL, LOSS OF PROFITS, LOSS OF SAVINGS, LOSS OF USE, LOSS OF DATA, OR BUSINESS INTERRUPTION. NO CLAIM, SUIT OR ACTION SHALL BE BROUGHT AGAINST TI MORE THAN ONE YEAR AFTER THE RELATED CAUSE OF ACTION HAS OCCURRED.
- 8.2 *Specific Limitations.* IN NO EVENT SHALL TI'S AGGREGATE LIABILITY FROM ANY WARRANTY OR OTHER OBLIGATION ARISING OUT OF OR IN CONNECTION WITH THESE TERMS AND CONDITIONS, OR ANY USE OF ANY TI EVM PROVIDED HEREUNDER, EXCEED THE TOTAL AMOUNT PAID TO TI FOR THE PARTICULAR UNITS SOLD UNDER THESE TERMS AND CONDITIONS WITH RESPECT TO WHICH LOSSES OR DAMAGES ARE CLAIMED. THE EXISTENCE OF MORE THAN ONE CLAIM AGAINST THE PARTICULAR UNITS SOLD TO USER UNDER THESE TERMS AND CONDITIONS SHALL NOT ENLARGE OR EXTEND THIS LIMIT.
9. *Return Policy.* Except as otherwise provided, TI does not offer any refunds, returns, or exchanges. Furthermore, no return of EVM(s) will be accepted if the package has been opened and no return of the EVM(s) will be accepted if they are damaged or otherwise not in a resalable condition. If User feels it has been incorrectly charged for the EVM(s) it ordered or that delivery violates the applicable order, User should contact TI. All refunds will be made in full within thirty (30) working days from the return of the components(s), excluding any postage or packaging costs.
10. *Governing Law:* These terms and conditions shall be governed by and interpreted in accordance with the laws of the State of Texas, without reference to conflict-of-laws principles. User agrees that non-exclusive jurisdiction for any dispute arising out of or relating to these terms and conditions lies within courts located in the State of Texas and consents to venue in Dallas County, Texas. Notwithstanding the foregoing, any judgment may be enforced in any United States or foreign court, and TI may seek injunctive relief in any United States or foreign court.

Mailing Address: Texas Instruments, Post Office Box 655303, Dallas, Texas 75265
Copyright © 2015, Texas Instruments Incorporated

IMPORTANT NOTICE

Texas Instruments Incorporated and its subsidiaries (TI) reserve the right to make corrections, enhancements, improvements and other changes to its semiconductor products and services per JESD46, latest issue, and to discontinue any product or service per JESD48, latest issue. Buyers should obtain the latest relevant information before placing orders and should verify that such information is current and complete. All semiconductor products (also referred to herein as "components") are sold subject to TI's terms and conditions of sale supplied at the time of order acknowledgment.

TI warrants performance of its components to the specifications applicable at the time of sale, in accordance with the warranty in TI's terms and conditions of sale of semiconductor products. Testing and other quality control techniques are used to the extent TI deems necessary to support this warranty. Except where mandated by applicable law, testing of all parameters of each component is not necessarily performed.

TI assumes no liability for applications assistance or the design of Buyers' products. Buyers are responsible for their products and applications using TI components. To minimize the risks associated with Buyers' products and applications, Buyers should provide adequate design and operating safeguards.

TI does not warrant or represent that any license, either express or implied, is granted under any patent right, copyright, mask work right, or other intellectual property right relating to any combination, machine, or process in which TI components or services are used. Information published by TI regarding third-party products or services does not constitute a license to use such products or services or a warranty or endorsement thereof. Use of such information may require a license from a third party under the patents or other intellectual property of the third party, or a license from TI under the patents or other intellectual property of TI.

Reproduction of significant portions of TI information in TI data books or data sheets is permissible only if reproduction is without alteration and is accompanied by all associated warranties, conditions, limitations, and notices. TI is not responsible or liable for such altered documentation. Information of third parties may be subject to additional restrictions.

Resale of TI components or services with statements different from or beyond the parameters stated by TI for that component or service voids all express and any implied warranties for the associated TI component or service and is an unfair and deceptive business practice. TI is not responsible or liable for any such statements.

Buyer acknowledges and agrees that it is solely responsible for compliance with all legal, regulatory and safety-related requirements concerning its products, and any use of TI components in its applications, notwithstanding any applications-related information or support that may be provided by TI. Buyer represents and agrees that it has all the necessary expertise to create and implement safeguards which anticipate dangerous consequences of failures, monitor failures and their consequences, lessen the likelihood of failures that might cause harm and take appropriate remedial actions. Buyer will fully indemnify TI and its representatives against any damages arising out of the use of any TI components in safety-critical applications.

In some cases, TI components may be promoted specifically to facilitate safety-related applications. With such components, TI's goal is to help enable customers to design and create their own end-product solutions that meet applicable functional safety standards and requirements. Nonetheless, such components are subject to these terms.

No TI components are authorized for use in FDA Class III (or similar life-critical medical equipment) unless authorized officers of the parties have executed a special agreement specifically governing such use.

Only those TI components which TI has specifically designated as military grade or "enhanced plastic" are designed and intended for use in military/aerospace applications or environments. Buyer acknowledges and agrees that any military or aerospace use of TI components which have **not** been so designated is solely at the Buyer's risk, and that Buyer is solely responsible for compliance with all legal and regulatory requirements in connection with such use.

TI has specifically designated certain components as meeting ISO/TS16949 requirements, mainly for automotive use. In any case of use of non-designated products, TI will not be responsible for any failure to meet ISO/TS16949.

Products

Audio	www.ti.com/audio
Amplifiers	amplifier.ti.com
Data Converters	dataconverter.ti.com
DLP® Products	www.dlp.com
DSP	dsp.ti.com
Clocks and Timers	www.ti.com/clocks
Interface	interface.ti.com
Logic	logic.ti.com
Power Mgmt	power.ti.com
Microcontrollers	microcontroller.ti.com
RFID	www.ti-rfid.com
OMAP Applications Processors	www.ti.com/omap
Wireless Connectivity	www.ti.com/wirelessconnectivity

Applications

Automotive and Transportation	www.ti.com/automotive
Communications and Telecom	www.ti.com/communications
Computers and Peripherals	www.ti.com/computers
Consumer Electronics	www.ti.com/consumer-apps
Energy and Lighting	www.ti.com/energy
Industrial	www.ti.com/industrial
Medical	www.ti.com/medical
Security	www.ti.com/security
Space, Avionics and Defense	www.ti.com/space-avionics-defense
Video and Imaging	www.ti.com/video

TI E2E Community

e2e.ti.com

Looking for pricing, stock, or lifecycle information?

Click below to explore more details on WIN SOURCE:

 [View BQ76PL455EVM](#) on WIN SOURCE

 [Texas Instruments](#) Information

Optimize Your Supply Chain with WIN SOURCE Solutions

-  Global Sourcing Solution
-  Obsolete Management
-  Cost Control Management
-  Shortage Management
-  Alternative Solution
-  Excess Inventory Management