



**THE DATASHEET OF
BGA748L16E6327XTSA1**



BGA748L16

High Linearity Quad-Band UMTS LNA (2100, 1900, 900, 800 MHz)

Data Sheet

Revision 3.2, 2010-06-18

Edition 2010-06-18

**Published by
Infineon Technologies AG
81726 Munich, Germany**

**© 2010 Infineon Technologies AG
All Rights Reserved.**

Legal Disclaimer

The information given in this document shall in no event be regarded as a guarantee of conditions or characteristics. With respect to any examples or hints given herein, any typical values stated herein and/or any information regarding the application of the device, Infineon Technologies hereby disclaims any and all warranties and liabilities of any kind, including without limitation, warranties of non-infringement of intellectual property rights of any third party.

Information

For further information on technology, delivery terms and conditions and prices, please contact the nearest Infineon Technologies Office (www.infineon.com).

Warnings

Due to technical requirements, components may contain dangerous substances. For information on the types in question, please contact the nearest Infineon Technologies Office.

Infineon Technologies components may be used in life-support devices or systems only with the express written approval of Infineon Technologies, if a failure of such components can reasonably be expected to cause the failure of that life-support device or system or to affect the safety or effectiveness of that device or system. Life support devices or systems are intended to be implanted in the human body or to support and/or maintain and sustain and/or protect human life. If they fail, it is reasonable to assume that the health of the user or other persons may be endangered.

BGA748L16 High Linearity Quad-Band UMTS LNA (2100, 1900, 900, 800 MHz)

Revision History: 2010-06-18, Revision 3.2

Previous Revision: 2010-01-19, Revision 3.1

Page	Subjects (major changes since last revision)

Trademarks of Infineon Technologies AG

BlueMoon™, COMNEON™, C166™, CROSSAVE™, CanPAK™, CIPOS™, CoolMOS™, CoolSET™, CORECONTROL™, DAVE™, EasyPIM™, EconoBRIDGE™, EconoDUAL™, EconoPACK™, EconoPIM™, EiceDRIVER™, EUPEC™, FCOS™, HITFET™, HybridPACK™, ISOFACE™, I²RF™, IsoPACK™, MIPAQ™, ModSTACK™, my-d™, NovalithIC™, OmniTune™, OptiMOS™, ORIGA™, PROFET™, PRO-SIL™, PRIMARION™, PrimePACK™, RASIC™, ReverSave™, SatRIC™, SensoNor™, SIEGET™, SINDRION™, SMARTi™, SmartLEWIS™, TEMPFET™, thinQ!™, TriCore™, TRENCHSTOP™, X-GOLD™, XMM™, X-PMU™, XPOSYS™.

Other Trademarks

Advance Design System™ (ADS) of Agilent Technologies, AMBA™, ARM™, MULTI-ICE™, PRIMECELL™, REALVIEW™, THUMB™ of ARM Limited, UK. AUTOSAR™ is licensed by AUTOSAR development partnership. Bluetooth™ of Bluetooth SIG Inc. CAT-iq™ of DECT Forum. COLOSSUS™, FirstGPS™ of Trimble Navigation Ltd. EMV™ of EMVCo, LLC (Visa Holdings Inc.). EPCOS™ of Epcos AG. FLEXGO™ of Microsoft Corporation. FlexRay™ is licensed by FlexRay Consortium. HYPERTERMINAL™ of Hilgraeve Incorporated. IEC™ of Commission Electrotechnique Internationale. IrDA™ of Infrared Data Association Corporation. ISO™ of INTERNATIONAL ORGANIZATION FOR STANDARDIZATION. MATLAB™ of MathWorks, Inc. MAXIM™ of Maxim Integrated Products, Inc. MICROTEC™, NUCLEUS™ of Mentor Graphics Corporation. Mifare™ of NXP. MIPI™ of MIPI Alliance, Inc. MIPS™ of MIPS Technologies, Inc., USA. muRata™ of MURATA MANUFACTURING CO., MICROWAVE OFFICE™ (MWO) of Applied Wave Research Inc., OmniVision™ of OmniVision Technologies, Inc. Openwave™ Openwave Systems Inc. RED HAT™ Red Hat, Inc. RFMD™ RF Micro Devices, Inc. SIRIUS™ of Sirius Sattelite Radio Inc. SOLARIS™ of Sun Microsystems, Inc. SPANSION™ of Spansion LLC Ltd. Symbian™ of Symbian Software Limited. TAIYO YUDEN™ of Taiyo Yuden Co. TEAKLITE™ of CEVA, Inc. TEKTRONIX™ of Tektronix Inc. TOKO™ of TOKO KABUSHIKI KAISHA TA. UNIX™ of X/Open Company Limited. VERILOG™, PALLADIUM™ of Cadence Design Systems, Inc. VLYNQ™ of Texas Instruments Incorporated. VXWORKS™, WIND RIVER™ of WIND RIVER SYSTEMS, INC. ZETEX™ of Diodes Zetex Limited.

Last Trademarks Update 2010-03-22

Table of Contents

	Table of Contents	4
	List of Figures	5
	List of Tables	6
1	Features	7
2	Electrical Characteristics	9
2.1	Absolute Maximum Ratings	9
2.2	Thermal Resistance	9
2.3	ESD Integrity	9
2.4	DC Characteristics	10
2.5	Band Select / Gain Control Truth Table	10
2.6	Supply Current Characteristics	11
2.7	Logic Signal Characteristics	12
2.8	Switching Times	12
2.9	Measured RF Characteristics UMTS Band V	13
2.10	Measured RF Characteristics UMTS Band V	14
2.11	Measured RF Characteristics UMTS Band V	15
2.12	Measured RF Characteristics UMTS Band VIII	16
2.13	Measured RF Characteristics UMTS Band VIII	17
2.14	Measured RF Characteristics UMTS Band VIII	18
2.15	Measured RF Characteristics UMTS Band II	19
2.16	Measured RF Characteristics UMTS Band II	20
2.17	Measured RF Characteristics UMTS Band II	21
2.18	Measured RF Characteristics UMTS Band I	22
2.19	Measured RF Characteristics UMTS Band I	23
2.20	Measured RF Characteristics UMTS Band I	24
3	Application Circuit and Block Diagram	25
3.1	UMTS Bands I, II, V and VIII Application Circuit Schematic	25
3.2	Pin Description	26
3.3	Application Board	27
4	Physical Characteristics	29
4.1	Package Footprint	29
4.2	Package Dimensions	30

List of Figures

Figure 1	Block Diagram of Quad-Band LNA	8
Figure 2	Application Circuit with Chip Outline (top view)	25
Figure 3	Cross-Section view of Application Board	27
Figure 4	Detail of Application Board Layout	28
Figure 5	Recommended Footprint and Stencil Layout for the TSLP-16-1 Package	29
Figure 6	Package Outline (top, side and bottom view)	30

List of Tables

Table 1	Absolute Maximum Ratings	9
Table 2	Thermal Resistance	9
Table 3	ESD Integrity	9
Table 4	DC Characteristics, $T_A = -30 \dots 85 \text{ }^\circ\text{C}$	10
Table 5	Band Select Truth Table, $V_{CC} = 2.8 \text{ V}$	10
Table 6	Gain Control Truth Table, $V_{CC} = 2.8 \text{ V}$	10
Table 7	Typical Switching Times; $T_A = -30 \dots 85 \text{ }^\circ\text{C}$	12
Table 8	Typical Characteristics 880 MHz Band, $T_A = -30 \text{ }^\circ\text{C}$, $V_{CC} = 2.8 \text{ V}$	13
Table 9	Typical Characteristics 880 MHz Band, $T_A = 25 \text{ }^\circ\text{C}$, $V_{CC} = 2.8 \text{ V}$	14
Table 10	Typical Characteristics 880 MHz Band, $T_A = 85 \text{ }^\circ\text{C}$, $V_{CC} = 2.8 \text{ V}$	15
Table 11	Typical Characteristics 940 MHz Band, $T_A = -30 \text{ }^\circ\text{C}$, $V_{CC} = 2.8 \text{ V}$	16
Table 12	Typical Characteristics 940 MHz Band, $T_A = 25 \text{ }^\circ\text{C}$, $V_{CC} = 2.8 \text{ V}$	17
Table 13	Typical Characteristics 940 MHz Band, $T_A = 85 \text{ }^\circ\text{C}$, $V_{CC} = 2.8 \text{ V}$	18
Table 14	Typical Characteristics 1960 MHz Band, $T_A = -30 \text{ }^\circ\text{C}$, $V_{CC} = 2.8 \text{ V}$	19
Table 15	Typical Characteristics 1960 MHz Band, $T_A = 25 \text{ }^\circ\text{C}$, $V_{CC} = 2.8 \text{ V}$	20
Table 16	Typical Characteristics 1960 MHz Band, $T_A = 85 \text{ }^\circ\text{C}$, $V_{CC} = 2.8 \text{ V}$	21
Table 17	Typical Characteristics 2140 MHz Band, $T_A = -30 \text{ }^\circ\text{C}$, $V_{CC} = 2.8 \text{ V}$	22
Table 18	Typical Characteristics 2140 MHz Band, $T_A = 25 \text{ }^\circ\text{C}$, $V_{CC} = 2.8 \text{ V}$	23
Table 19	Typical Characteristics 2140 MHz Band, $T_A = 85 \text{ }^\circ\text{C}$, $V_{CC} = 2.8 \text{ V}$	24
Table 20	Parts List	25
Table 21	Pin Definition and Function	26

1 Features

Main features:

- Gain: 16 / -8 dB typ. in high / low gain mode (all bands)
- Noise figure: 1.1 dB typ. in high gain mode
- Supply current: 4.0 / 0.75 mA typ in high / low gain mode (all bands)
- Standby mode (< 2 μ A typ.)
- Output internally matched to 50 Ω
- Inputs pre-matched to 50 Ω
- 2 kV HBM ESD protection
- Low external component count
- Small leadless TSLP-16-1 package (2.3 x 2.3 x 0.39 mm)
- Pb-free (RoHS compliant) package

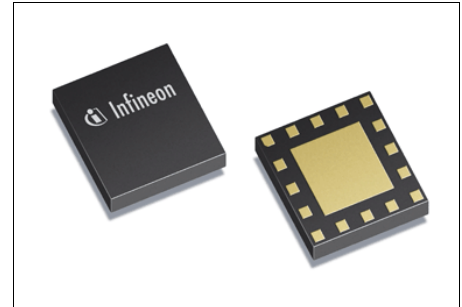

Description

The BGA748L16 is a highly flexible, high linearity quad-band (2100, 1900, 900, 800 MHz) low noise amplifier MMIC for worldwide use. Based on Infineon's proprietary and cost-effective SiGe:C technology, the BGA748L16 uses an advanced biasing concept in order to achieve high linearity.

The device features dynamic gain control, temperature stabilization, standby mode and 2 kV ESD protection on-chip as well as matching off chip. Because the matching is off chip, different UMTS bands can be easily applied.

Note: UMTS bands I / II / V / VIII is the standard band combination for this product requiring no external output matching network.

Product Name	Package	Chip	Marking
BGA748L16	TSLP-16-1	T1541	BGA748

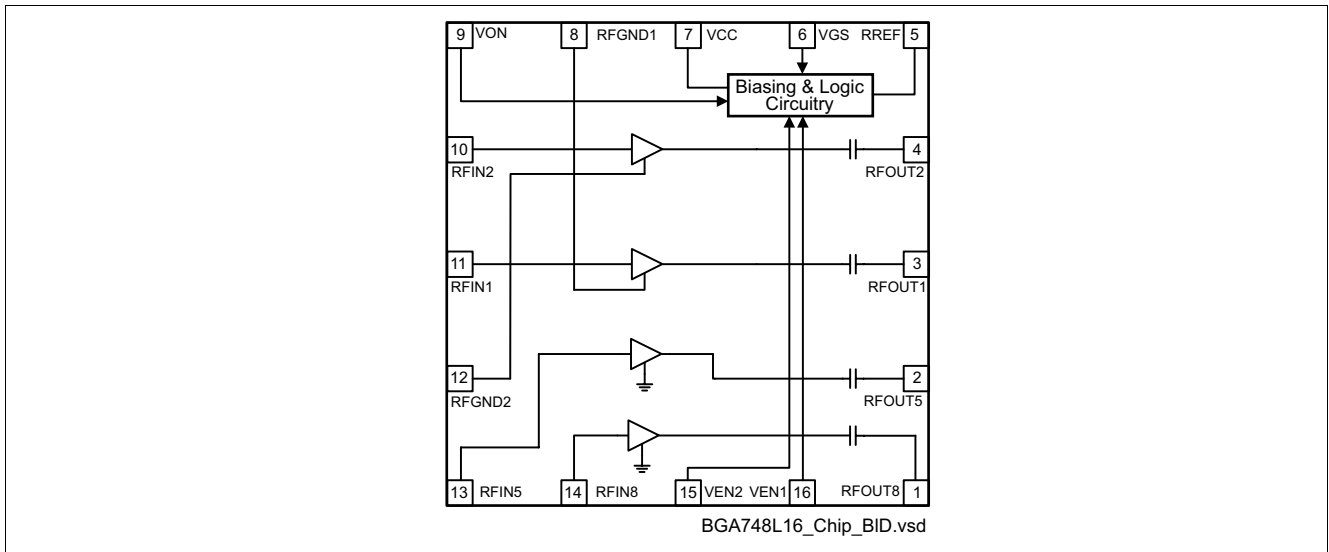

Figure 1 Block Diagram of Quad-Band LNA

2 Electrical Characteristics

2.1 Absolute Maximum Ratings

Table 1 Absolute Maximum Ratings

Parameter	Symbol	Values			Unit	Note / Test Condition
		Min.	Typ.	Max.		
Supply voltage	V_{CC}	-0.3	–	3.6	V	–
Supply current	I_{CC}	–	–	10	mA	–
Pin voltage	V_{PIN}	-0.3	–	$V_{CC}+0.3$	V	All pins except RF input pins.
Pin voltage RF Input Pins	V_{RFIN}	-0.3	–	0.9	V	–
RF input power	P_{RFIN}	–	–	4	dBm	–
Junction temperature	T_j	–	–	150	°C	–
Ambient temperature range	T_A	-30	–	85	°C	–
Storage temperature range	T_{stg}	-65	–	150	°C	–

Attention: Stresses exceeding the max. values listed here may cause permanent damage to the device. Exposure to absolute maximum rating conditions for extended periods may affect device reliability. Maximum ratings are absolute ratings; exceeding only one of these values may cause irreversible damage to the integrated circuit.

2.2 Thermal Resistance

Table 2 Thermal Resistance

Parameter	Symbol	Values			Unit	Note / Test Condition
		Min.	Typ.	Max.		
Thermal resistance junction to soldering point	R_{thJS}	–	67	–	K/W	–

2.3 ESD Integrity

Table 3 ESD Integrity

Parameter	Symbol	Values			Unit	Note / Test Condition
		Min.	Typ.	Max.		
ESD hardness HBM ¹⁾	$V_{ESD-HBM}$	–	2000	–	V	All pins

1) According to JESD22-A114

2.4 DC Characteristics

Table 4 DC Characteristics, $T_A = -30 \dots 85 \text{ }^\circ\text{C}$

Parameter	Symbol	Values			Unit	Note / Test Condition
		Min.	Typ.	Max.		
Supply voltage	V_{CC}	2.6	2.8	3.0	V	–
Supply current high gain mode	I_{CCHG}	–	4.4 3.8	–	mA	Band 1 All other bands
Supply current low gain mode	I_{CCLG}	–	0.75	–	mA	All bands
Supply current standby mode	I_{CCOFF}	–	0.1	2.0	μA	–
Logic level high	V_{HI}	1.5	2.8	–	V	All logic pins
Logic level low	V_{LO}	–	0.0	0.5	V	
Logic currents	I_{LO}	–	0.1	–	μA	All logic pins
	I_{HI}	–	5.0	–	μA	

2.5 Band Select / Gain Control Truth Table

Table 5 Band Select Truth Table, $V_{CC} = 2.8 \text{ V}$

	Band 1	Band 2	Band 5	Band 8	Stand-by
VEN1	H	H	L	L	L
VEN2	H	L	H	L	L
VON	H	H	H	H	L

Table 6 Gain Control Truth Table, $V_{CC} = 2.8 \text{ V}$

	High Gain	Low Gain
VGS	H	L

2.6 Supply Current Characteristics

Supply current high gain mode versus resistance of reference resistor (resistor R_{REF} in Figure 3.1 on Page 25); low gain mode supply current is independent of reference resistor).

Supply Current Band 5 $I_{CC} = f(R_{REF})$
 $V_{CC} = 2.8\text{ V}$, $T_A = 25\text{ }^\circ\text{C}$

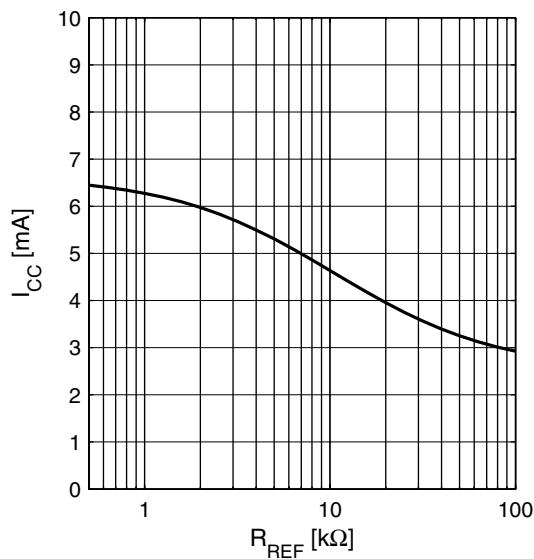

Supply Current Band 8 $I_{CC} = f(R_{REF})$
 $V_{CC} = 2.8\text{ V}$, $T_A = 25\text{ }^\circ\text{C}$

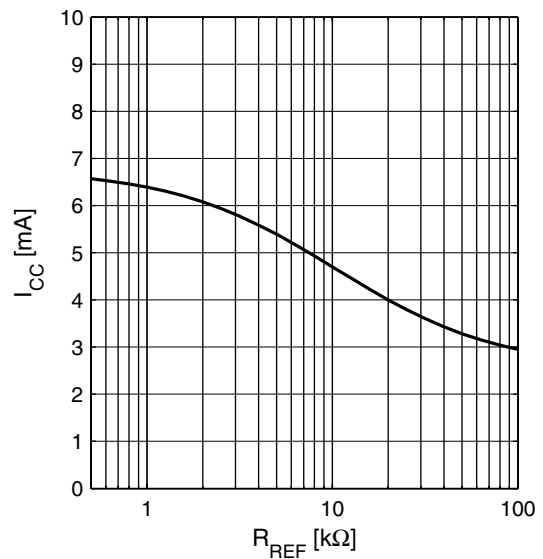

Supply Current Band 2 $I_{CC} = f(R_{REF})$
 $V_{CC} = 2.8\text{ V}$, $T_A = 25\text{ }^\circ\text{C}$

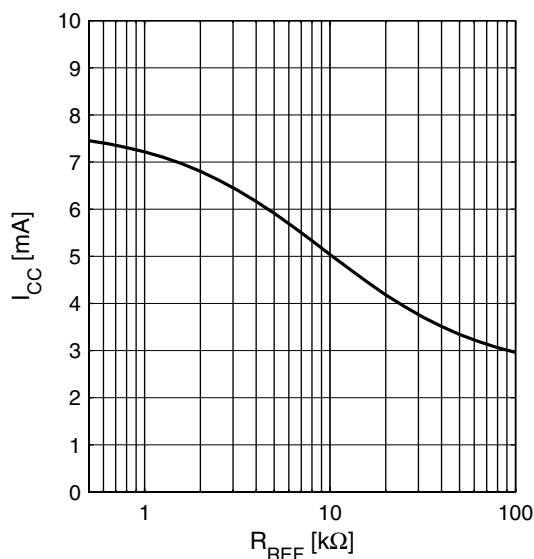

Supply Current Band 1 $I_{CC} = f(R_{REF})$
 $V_{CC} = 2.8\text{ V}$, $T_A = 25\text{ }^\circ\text{C}$

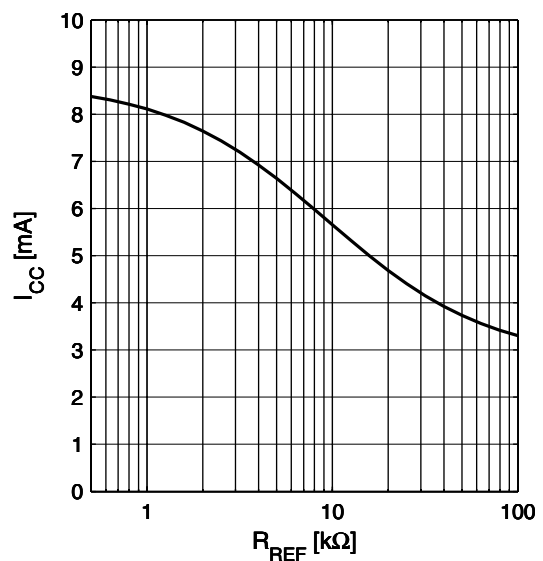

2.7 Logic Signal Characteristics

Current consumption of logic inputs VEN1, VEN2, VGS, VON

Logic currents $I_{\text{LOG}} = f(V_{\text{LOG}})$
 $V_{\text{CC}} = 2.8 \text{ V}$, $T_{\text{A}} = 25 \text{ }^{\circ}\text{C}$

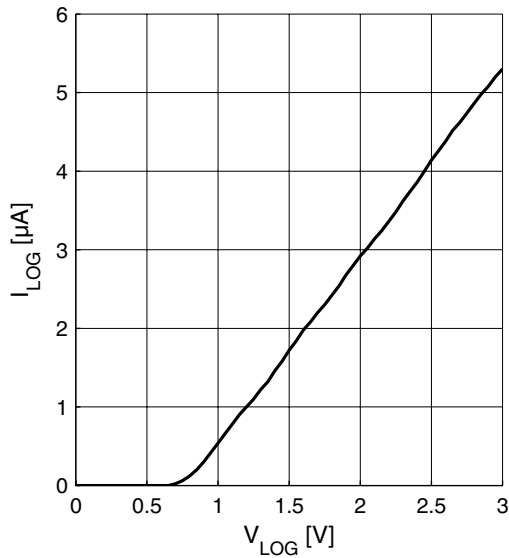

2.8 Switching Times

Table 7 Typical Switching Times; $T_{\text{A}} = -30 \dots 85 \text{ }^{\circ}\text{C}$

Parameter	Symbol	Values			Unit	Note / Test Condition
		Min.	Typ.	Max.		
Gainstep settling time	t_{GS}	–	1	–	µs	Switching LG ↔ HG all bands
Bandselect settling time	t_{BS}	–	1	–	µs	Switching from any band to a different band (pins VEN1,2)
Power on settling time	t_{ON}	–	1	–	µs	Switching from standby mode to ON mode (pin VON)

2.9 Measured RF Characteristics UMTS Band V

Table 8 Typical Characteristics 880 MHz Band, $T_A = -30\text{ °C}$, $V_{CC} = 2.8\text{ V}^{1)}$

Parameter	Symbol	Values			Unit	Note / Test Condition
		Min.	Typ.	Max.		
Pass band range		869	–	894	MHz	–
Current consumption	I_{CCHG}	–	3.1	–	mA	High gain mode
	I_{CCLG}	–	0.70	–	mA	Low gain mode
Gain	S_{21HG}	–	16.5	–	dB	High gain mode
	S_{21LG}	–	-7.8	–	dB	Low gain mode
Reverse Isolation ²⁾	S_{12HG}	–	-38	–	dB	High gain mode
	S_{12LG}	–	-7.8	–	dB	Low gain mode
Noise figure	NF_{HG}	–	0.9	–	dB	High gain mode
	NF_{LG}	–	7.8	–	dB	Low gain mode
Input return loss ²⁾	S_{11HG}	–	-15	–	dB	50 Ω , high gain mode
	S_{11LG}	–	-17	–	dB	50 Ω , low gain mode
Output return loss ²⁾	S_{22HG}	–	-15	–	dB	50 Ω , high gain mode
	S_{22LG}	–	-11	–	dB	50 Ω , low gain mode
Stability factor ³⁾	k	–	>2.5	–		DC to 8 GHz; all gain modes
Input compression point ²⁾	IP_{1dBHG}	–	-7	–	dBm	High gain mode
	IP_{1dBLG}	–	1	–	dBm	Low gain mode
Inband IIP3 ²⁾ $f_1 - f_2 = 1\text{ MHz}$	$IIP3_{HG}$	–	-7	–	dBm	High gain mode
	$IIP3_{LG}$	–	14	–	dBm	Low gain mode

1) Performance based on application circuit in Figure 3.1 on Page 25

2) Verification based on AQL; random production test.

3) Guaranteed by device design; not tested in production.

2.10 Measured RF Characteristics UMTS Band V

Table 9 Typical Characteristics 880 MHz Band, $T_A = 25\text{ °C}$, $V_{CC} = 2.8\text{ V}^{1)}$

Parameter	Symbol	Values			Unit	Note / Test Condition
		Min.	Typ.	Max.		
Pass band range		869	–	894	MHz	–
Current consumption	I_{CCHG}	–	3.8	–	mA	High gain mode
	I_{CCLG}	–	0.75	–	mA	Low gain mode
Gain	S_{21HG}	–	16.2	–	dB	High gain mode
	S_{21LG}	–	-8.0	–	dB	Low gain mode
Reverse Isolation ²⁾	S_{12HG}	–	-38	–	dB	High gain mode
	S_{12LG}	–	-8.0	–	dB	Low gain mode
Noise figure	NF_{HG}	–	1.2	–	dB	High gain mode
	NF_{LG}	–	8.0	–	dB	Low gain mode
Input return loss ²⁾	S_{11HG}	–	-14	–	dB	50 Ω , high gain mode
	S_{11LG}	–	-15	–	dB	50 Ω , low gain mode
Output return loss ²⁾	S_{22HG}	–	-20	–	dB	50 Ω , high gain mode
	S_{22LG}	–	-11	–	dB	50 Ω , low gain mode
Stability factor ³⁾	k	–	>2.7	–		DC to 8 GHz; all gain modes
Input compression point ²⁾	IP_{1dBHG}	–	-7	–	dBm	High gain mode
	IP_{1dBLG}	–	-1	–	dBm	Low gain mode
Inband IIP3 ²⁾ $f_1 - f_2 = 1\text{ MHz}$	$IIP3_{HG}$	–	-6	–	dBm	High gain mode
	$IIP3_{LG}$	–	12	–	dBm	Low gain mode

1) Performance based on application circuit in Figure 3.1 on Page 25

2) Verification based on AQL; random production test.

3) Guaranteed by device design; not tested in production.

2.11 Measured RF Characteristics UMTS Band V

Table 10 Typical Characteristics 880 MHz Band, $T_A = 85\text{ °C}$, $V_{CC} = 2.8\text{ V}^{1)}$

Parameter	Symbol	Values			Unit	Note / Test Condition
		Min.	Typ.	Max.		
Pass band range		869	–	894	MHz	–
Current consumption	I_{CCHG}	–	4.6	–	mA	High gain mode
	I_{CCLG}	–	0.80	–	mA	Low gain mode
Gain	S_{21HG}	–	15.6	–	dB	High gain mode
	S_{21LG}	–	-8.5	–	dB	Low gain mode
Reverse Isolation ²⁾	S_{12HG}	–	-38	–	dB	High gain mode
	S_{12LG}	–	-8.5	–	dB	Low gain mode
Noise figure	NF_{HG}	–	1.7	–	dB	High gain mode
	NF_{LG}	–	8.5	–	dB	Low gain mode
Input return loss ²⁾	S_{11HG}	–	-17	–	dB	50 Ω , high gain mode
	S_{11LG}	–	-14	–	dB	50 Ω , low gain mode
Output return loss ²⁾	S_{22HG}	–	-20	–	dB	50 Ω , high gain mode
	S_{22LG}	–	-11	–	dB	50 Ω , low gain mode
Stability factor ³⁾	k	–	>3.2	–		DC to 8 GHz; all gain modes
Input compression point ²⁾	IP_{1dBHG}	–	-8	–	dBm	High gain mode
	IP_{1dBLG}	–	-4	–	dBm	Low gain mode
Inband IIP3 ²⁾ $f_1 - f_2 = 1\text{ MHz}$	$IIP3_{HG}$	–	-6	–	dBm	High gain mode
	$IIP3_{LG}$	–	6	–	dBm	Low gain mode

1) Performance based on application circuit in Figure 3.1 on Page 25

2) Verification based on AQL; random production test.

3) Guaranteed by device design; not tested in production.

2.12 Measured RF Characteristics UMTS Band VIII

Table 11 Typical Characteristics 940 MHz Band, $T_A = -30\text{ °C}$, $V_{CC} = 2.8\text{ V}^1$

Parameter	Symbol	Values			Unit	Note / Test Condition
		Min.	Typ.	Max.		
Pass band range		925	–	960	MHz	–
Current consumption	I_{CCHG}	–	3.1	–	mA	High gain mode
	I_{CCLG}	–	0.70	–	mA	Low gain mode
Gain	S_{21HG}	–	16.5	–	dB	High gain mode
	S_{21LG}	–	-7.8	–	dB	Low gain mode
Reverse Isolation ²⁾	S_{12HG}	–	-35	–	dB	High gain mode
	S_{12LG}	–	-7.8	–	dB	Low gain mode
Noise figure	NF_{HG}	–	0.9	–	dB	High gain mode
	NF_{LG}	–	7.8	–	dB	Low gain mode
Input return loss ²⁾	S_{11HG}	–	-15	–	dB	50 Ω , high gain mode
	S_{11LG}	–	-13	–	dB	50 Ω , low gain mode
Output return loss ²⁾	S_{22HG}	–	-19	–	dB	50 Ω , high gain mode
	S_{22LG}	–	-13	–	dB	50 Ω , low gain mode
Stability factor ³⁾	k	–	>2.5	–		DC to 8 GHz; all gain modes
Input compression point ²⁾	IP_{1dBHG}	–	-7	–	dBm	High gain mode
	IP_{1dBLG}	–	3	–	dBm	Low gain mode
Inband IIP3 ²⁾ $f_1 - f_2 = 1\text{ MHz}$	$IIP3_{HG}$	–	-7	–	dBm	High gain mode
	$IIP3_{LG}$	–	14	–	dBm	Low gain mode

1) Performance based on application circuit in Figure 3.1 on Page 25

2) Verification based on AQL; random production test.

3) Guaranteed by device design; not tested in production.

2.13 Measured RF Characteristics UMTS Band VIII

Table 12 Typical Characteristics 940 MHz Band, $T_A = 25\text{ °C}$, $V_{CC} = 2.8\text{ V}^{1)}$

Parameter	Symbol	Values			Unit	Note / Test Condition
		Min.	Typ.	Max.		
Pass band range		925	–	960	MHz	–
Current consumption	I_{CCHG}	–	3.8	–	mA	High gain mode
	I_{CCLG}	–	0.75	–	mA	Low gain mode
Gain	S_{21HG}	–	16.2	–	dB	High gain mode
	S_{21LG}	–	-8.0	–	dB	Low gain mode
Reverse Isolation ²⁾	S_{12HG}	–	-36	–	dB	High gain mode
	S_{12LG}	–	-8.0	–	dB	Low gain mode
Noise figure	NF_{HG}	–	1.2	–	dB	High gain mode
	NF_{LG}	–	8.0	–	dB	Low gain mode
Input return loss ²⁾	S_{11HG}	–	-16	–	dB	50 Ω , high gain mode
	S_{11LG}	–	-13	–	dB	50 Ω , low gain mode
Output return loss ²⁾	S_{22HG}	–	-28	–	dB	50 Ω , high gain mode
	S_{22LG}	–	-12	–	dB	50 Ω , low gain mode
Stability factor ³⁾	k	–	>2.8	–		DC to 8 GHz; all gain modes
Input compression point ²⁾	IP_{1dBHG}	–	-6	–	dBm	High gain mode
	IP_{1dBLG}	–	1	–	dBm	Low gain mode
Inband IIP3 ²⁾ $f_1 - f_2 = 1\text{ MHz}$	$IIP3_{HG}$	–	-6	–	dBm	High gain mode
	$IIP3_{LG}$	–	12	–	dBm	Low gain mode

1) Performance based on application circuit in Figure 3.1 on Page 25

2) Verification based on AQL; random production test.

3) Guaranteed by device design; not tested in production.

2.14 Measured RF Characteristics UMTS Band VIII

Table 13 Typical Characteristics 940 MHz Band, $T_A = 85\text{ °C}$, $V_{CC} = 2.8\text{ V}^{1)}$

Parameter	Symbol	Values			Unit	Note / Test Condition
		Min.	Typ.	Max.		
Pass band range		925	–	960	MHz	–
Current consumption	I_{CCHG}	–	4.6	–	mA	High gain mode
	I_{CCLG}	–	0.80	–	mA	Low gain mode
Gain	S_{21HG}	–	15.6	–	dB	High gain mode
	S_{21LG}	–	-8.5	–	dB	Low gain mode
Reverse Isolation ²⁾	S_{12HG}	–	-36	–	dB	High gain mode
	S_{12LG}	–	-8.5	–	dB	Low gain mode
Noise figure	NF_{HG}	–	1.7	–	dB	High gain mode
	NF_{LG}	–	8.5	–	dB	Low gain mode
Input return loss ²⁾	S_{11HG}	–	-17	–	dB	50 Ω , high gain mode
	S_{11LG}	–	-12	–	dB	50 Ω , low gain mode
Output return loss ²⁾	S_{22HG}	–	-26	–	dB	50 Ω , high gain mode
	S_{22LG}	–	-12	–	dB	50 Ω , low gain mode
Stability factor ³⁾	k	–	>3.2	–		DC to 8 GHz; all gain modes
Input compression point ²⁾	IP_{1dBHG}	–	-9	–	dBm	High gain mode
	$IP_{1dB LG}$	–	-3	–	dBm	Low gain mode
Inband IIP3 ²⁾ $f_1 - f_2 = 1\text{ MHz}$	$IIP3_{HG}$	–	-5	–	dBm	High gain mode
	$IIP3_{LG}$	–	5	–	dBm	Low gain mode

1) Performance based on application circuit in Figure 3.1 on Page 25

2) Verification based on AQL; random production test.

3) Guaranteed by device design; not tested in production.

2.15 Measured RF Characteristics UMTS Band II

Table 14 Typical Characteristics 1960 MHz Band, $T_A = -30\text{ °C}$, $V_{CC} = 2.8\text{ V}^{1)}$

Parameter	Symbol	Values			Unit	Note / Test Condition
		Min.	Typ.	Max.		
Pass band range		1930	–	1990	MHz	–
Current consumption	I_{CCHG}	–	3.1	–	mA	High gain mode
	I_{CCLG}	–	0.70	–	mA	Low gain mode
Gain	S_{21HG}	–	17.1	–	dB	High gain mode
	S_{21LG}	–	-7.8	–	dB	Low gain mode
Reverse Isolation ²⁾	S_{12HG}	–	-35	–	dB	High gain mode
	S_{12LG}	–	-7.8	–	dB	Low gain mode
Noise figure	NF_{HG}	–	0.8	–	dB	High gain mode
	NF_{LG}	–	7.8	–	dB	Low gain mode
Input return loss ²⁾	S_{11HG}	–	-21	–	dB	50 Ω , high gain mode
	S_{11LG}	–	-24	–	dB	50 Ω , low gain mode
Output return loss ²⁾	S_{22HG}	–	-29	–	dB	50 Ω , high gain mode
	S_{22LG}	–	-15	–	dB	50 Ω , low gain mode
Stability factor ³⁾	k	–	>2.3	–		DC to 8 GHz; all gain modes
Input compression point ²⁾	IP_{1dBHG}	–	-8	–	dBm	High gain mode
	IP_{1dBLG}	–	2	–	dBm	Low gain mode
Inband IIP3 ²⁾ $f_1 - f_2 = 1\text{ MHz}$	$IIP3_{HG}$	–	-8	–	dBm	High gain mode
	$IIP3_{LG}$	–	17	–	dBm	Low gain mode

1) Performance based on application circuit in Figure 3.1 on Page 25

2) Verification based on AQL; random production test.

3) Guaranteed by device design; not tested in production.

2.16 Measured RF Characteristics UMTS Band II

Table 15 Typical Characteristics 1960 MHz Band, $T_A = 25\text{ °C}$, $V_{CC} = 2.8\text{ V}^{1)}$

Parameter	Symbol	Values			Unit	Note / Test Condition
		Min.	Typ.	Max.		
Pass band range		1930	–	1990	MHz	–
Current consumption	I_{CCHG}	–	4.0	–	mA	High gain mode
	I_{CCLG}	–	0.75	–	mA	Low gain mode
Gain	S_{21HG}	–	16.5	–	dB	High gain mode
	S_{21LG}	–	-8.0	–	dB	Low gain mode
Reverse Isolation ²⁾	S_{12HG}	–	-36	–	dB	High gain mode
	S_{12LG}	–	-8.0	–	dB	Low gain mode
Noise figure	NF_{HG}	–	1.1	–	dB	High gain mode
	NF_{LG}	–	8.0	–	dB	Low gain mode
Input return loss ²⁾	S_{11HG}	–	-20	–	dB	50 Ω , high gain mode
	S_{11LG}	–	-17	–	dB	50 Ω , low gain mode
Output return loss ²⁾	S_{22HG}	–	-32	–	dB	50 Ω , high gain mode
	S_{22LG}	–	-15	–	dB	50 Ω , low gain mode
Stability factor ³⁾	k	–	>2.6	–		DC to 8 GHz; all gain modes
Input compression point ²⁾	IP_{1dBHG}	–	-8	–	dBm	High gain mode
	IP_{1dBLG}	–	2	–	dBm	Low gain mode
Inband IIP3 ²⁾ $f_1 - f_2 = 1\text{ MHz}$	$IIP3_{HG}$	–	-7	–	dBm	High gain mode
	$IIP3_{LG}$	–	17	–	dBm	Low gain mode

1) Performance based on application circuit in Figure 3.1 on Page 25

2) Verification based on AQL; random production test.

3) Guaranteed by device design; not tested in production.

2.17 Measured RF Characteristics UMTS Band II

Table 16 Typical Characteristics 1960 MHz Band, $T_A = 85\text{ °C}$, $V_{CC} = 2.8\text{ V}^{1)}$

Parameter	Symbol	Values			Unit	Note / Test Condition
		Min.	Typ.	Max.		
Pass band range		1930	–	1990	MHz	–
Current consumption	I_{CCHG}	–	4.9	–	mA	High gain mode
	I_{CCLG}	–	0.80	–	mA	Low gain mode
Gain	S_{21HG}	–	15.9	–	dB	High gain mode
	S_{21LG}	–	-8.5	–	dB	Low gain mode
Reverse Isolation ²⁾	S_{12HG}	–	-36	–	dB	High gain mode
	S_{12LG}	–	-8.5	–	dB	Low gain mode
Noise figure	NF_{HG}	–	1.5	–	dB	High gain mode
	NF_{LG}	–	8.5	–	dB	Low gain mode
Input return loss ²⁾	S_{11HG}	–	-17	–	dB	50 Ω , high gain mode
	S_{11LG}	–	-14	–	dB	50 Ω , low gain mode
Output return loss ²⁾	S_{22HG}	–	-23	–	dB	50 Ω , high gain mode
	S_{22LG}	–	-16	–	dB	50 Ω , low gain mode
Stability factor ³⁾	k	–	>3.1	–		DC to 8 GHz; all gain modes
Input compression point ²⁾	IP_{1dBHG}	–	-9	–	dBm	High gain mode
	IP_{1dBLG}	–	0	–	dBm	Low gain mode
Inband IIP3 ²⁾ $f_1 - f_2 = 1\text{ MHz}$	$IIP3_{HG}$	–	-6	–	dBm	High gain mode
	$IIP3_{LG}$	–	10	–		Low gain mode

1) Performance based on application circuit in Figure 3.1 on Page 25

2) Verification based on AQL; random production test.

3) Guaranteed by device design; not tested in production.

2.18 Measured RF Characteristics UMTS Band I

Table 17 Typical Characteristics 2140 MHz Band, $T_A = -30\text{ °C}$, $V_{CC} = 2.8\text{ V}^{1)}$

Parameter	Symbol	Values			Unit	Note / Test Condition
		Min.	Typ.	Max.		
Pass band range		2110	–	2170	MHz	–
Current consumption	I_{CCHG}	–	3.6	–	mA	High gain mode
	I_{CCLG}	–	0.70	–	mA	Low gain mode
Gain	S_{21HG}	–	18.0	–	dB	High gain mode
	S_{21LG}	–	-7.8	–	dB	Low gain mode
Reverse Isolation ²⁾	S_{12HG}	–	-36	–	dB	High gain mode
	S_{12LG}	–	-7.8	–	dB	Low gain mode
Noise figure	NF_{HG}	–	0.8	–	dB	High gain mode
	NF_{LG}	–	7.8	–	dB	Low gain mode
Input return loss ²⁾	S_{11HG}	–	-18	–	dB	50 Ω , high gain mode
	S_{11LG}	–	-18	–	dB	50 Ω , low gain mode
Output return loss ²⁾	S_{22HG}	–	-18	–	dB	50 Ω , high gain mode
	S_{22LG}	–	-10	–	dB	50 Ω , low gain mode
Stability factor ³⁾	k	–	>2.2	–		DC to 8 GHz; all gain modes
Input compression point ²⁾	IP_{1dBHG}	–	-9	–	dBm	High gain mode
	IP_{1dBLG}	–	1	–	dBm	Low gain mode
Inband IIP3 ²⁾ $f_1 - f_2 = 1\text{ MHz}$	$IIP3_{HG}$	–	-8	–	dBm	High gain mode
	$IIP3_{LG}$	–	16	–	dBm	Low gain mode

1) Performance based on application circuit in Figure 3.1 on Page 25

2) Verification based on AQL; random production test..

3) Guaranteed by device design; not tested in production.

2.19 Measured RF Characteristics UMTS Band I

Table 18 Typical Characteristics 2140 MHz Band, $T_A = 25\text{ °C}$, $V_{CC} = 2.8\text{ V}^{1)}$

Parameter	Symbol	Values			Unit	Note / Test Condition
		Min.	Typ.	Max.		
Pass band range		2110	–	2170	MHz	–
Current consumption	I_{CCHG}	–	4.4	–	mA	High gain mode
	I_{CCLG}	–	0.75	–	mA	Low gain mode
Gain	S_{21HG}	–	17.4	–	dB	High gain mode
	S_{21LG}	–	-8.0	–	dB	Low gain mode
Reverse Isolation ²⁾	S_{12HG}	–	-36	–	dB	High gain mode
	S_{12LG}	–	-8.0	–	dB	Low gain mode
Noise figure	NF_{HG}	–	1.1	–	dB	High gain mode
	NF_{LG}	–	8.0	–	dB	Low gain mode
Input return loss ²⁾	S_{11HG}	–	-20	–	dB	50 Ω , high gain mode
	S_{11LG}	–	-17	–	dB	50 Ω , low gain mode
Output return loss ²⁾	S_{22HG}	–	-19	–	dB	50 Ω , high gain mode
	S_{22LG}	–	-11	–	dB	50 Ω , low gain mode
Stability factor ³⁾	k	–	>2.4	–		DC to 8 GHz; all gain modes
Input compression point ²⁾	IP_{1dBHG}	–	-10	–	dBm	High gain mode
	IP_{1dBLG}	–	2	–	dBm	Low gain mode
Inband IIP3 ²⁾ $f_1 - f_2 = 1\text{ MHz}$	$IIP3_{HG}$	–	-6	–	dBm	High gain mode
	$IIP3_{LG}$	–	16	–	dBm	Low gain mode

1) Performance based on application circuit in Figure 3.1 on Page 25

2) Verification based on AQL; random production test..

3) Guaranteed by device design; not tested in production.

2.20 Measured RF Characteristics UMTS Band I

Table 19 Typical Characteristics 2140 MHz Band, $T_A = 85\text{ °C}$, $V_{CC} = 2.8\text{ V}^{1)}$

Parameter	Symbol	Values			Unit	Note / Test Condition
		Min.	Typ.	Max.		
Pass band range		2110	–	2170	MHz	–
Current consumption	I_{CCHG}	–	5.3	–	mA	High gain mode
	I_{CCLG}	–	0.80	–	mA	Low gain mode
Gain	S_{21HG}	–	16.8	–	dB	High gain mode
	S_{21LG}	–	-8.5	–	dB	Low gain mode
Reverse Isolation ²⁾	S_{12HG}	–	-36	–	dB	High gain mode
	S_{12LG}	–	-8.5	–	dB	Low gain mode
Noise figure	NF_{HG}	–	1.4	–	dB	High gain mode
	NF_{LG}	–	8.5	–	dB	Low gain mode
Input return loss ²⁾	S_{11HG}	–	-23	–	dB	50 Ω , high gain mode
	S_{11LG}	–	-16	–	dB	50 Ω , low gain mode
Output return loss ²⁾	S_{22HG}	–	-17	–	dB	50 Ω , high gain mode
	S_{22LG}	–	-11	–	dB	50 Ω , low gain mode
Stability factor ³⁾	k	–	>2.7	–		DC to 8 GHz; all gain modes
Input compression point ²⁾	IP_{1dBHG}	–	-11	–	dBm	High gain mode
	$IP_{1dB LG}$	–	1	–	dBm	Low gain mode
Inband IIP3 ²⁾ $f_1 - f_2 = 1\text{ MHz}$	$IIP3_{HG}$	–	-5	–	dBm	High gain mode
	$IIP3_{LG}$	–	11	–	dBm	Low gain mode

1) Performance based on application circuit in Figure 3.1 on Page 25

2) Verification based on AQL; random production test..

3) Guaranteed by device design; not tested in production.

3 Application Circuit and Block Diagram

3.1 UMTS Bands I, II, V and VIII Application Circuit Schematic

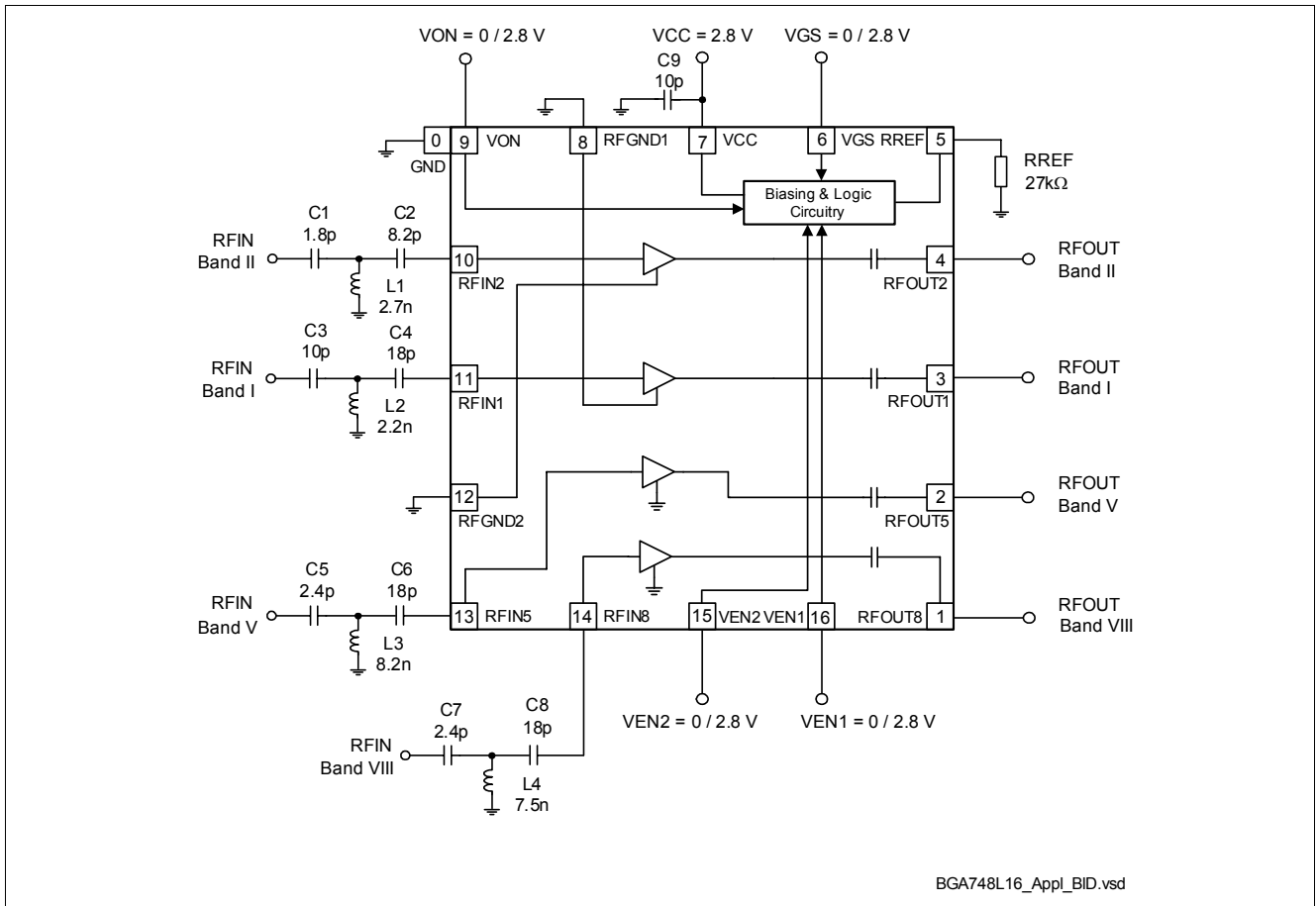

Figure 2 Application Circuit with Chip Outline (top view)

Note: Package paddle (Pin 0) has to be RF grounded.

Table 20 Parts List

Part Number	Part Type	Manufacturer	Size	Comment
L1 ... L4	Chip inductor	Various	0402	Wirewound, Q ≈ 50
C1 ... C9	Chip capacitor	Various	0402	
R1	Chip resistor	Various	0402	

3.2 Pin Description

Table 21 Pin Definition and Function

Pin No.	Name	Function
0	GND	Ground Package paddle; ground connection for band V and VIII LNA and control circuitry.
1	RFOUT8	LNA output UMTS band VIII
2	RFOUT5	LNA output UMTS band V
3	RFOUT1	LNA output UMTS band I
4	RFOUT2	LNA output UMTS band II
5	RREF	Bias current reference resistor (high gain mode)
6	VGS	Gain step control voltage
7	VCC	Supply voltage
8	RFGND1	LNA emitter ground UMTS band I
9	VON	Power on control voltage
10	RFIN2	LNA input UMTS band II
11	RFIN1	LNA input UMTS band I
12	RFGND2	LNA emitter ground UMTS band II
13	RFIN5	LNA input UMTS band V
14	RFIN8	LNA input UMTS band VIII
15	VEN2	Band select control voltage
16	VEN1	Band select control voltage

3.3 Application Board

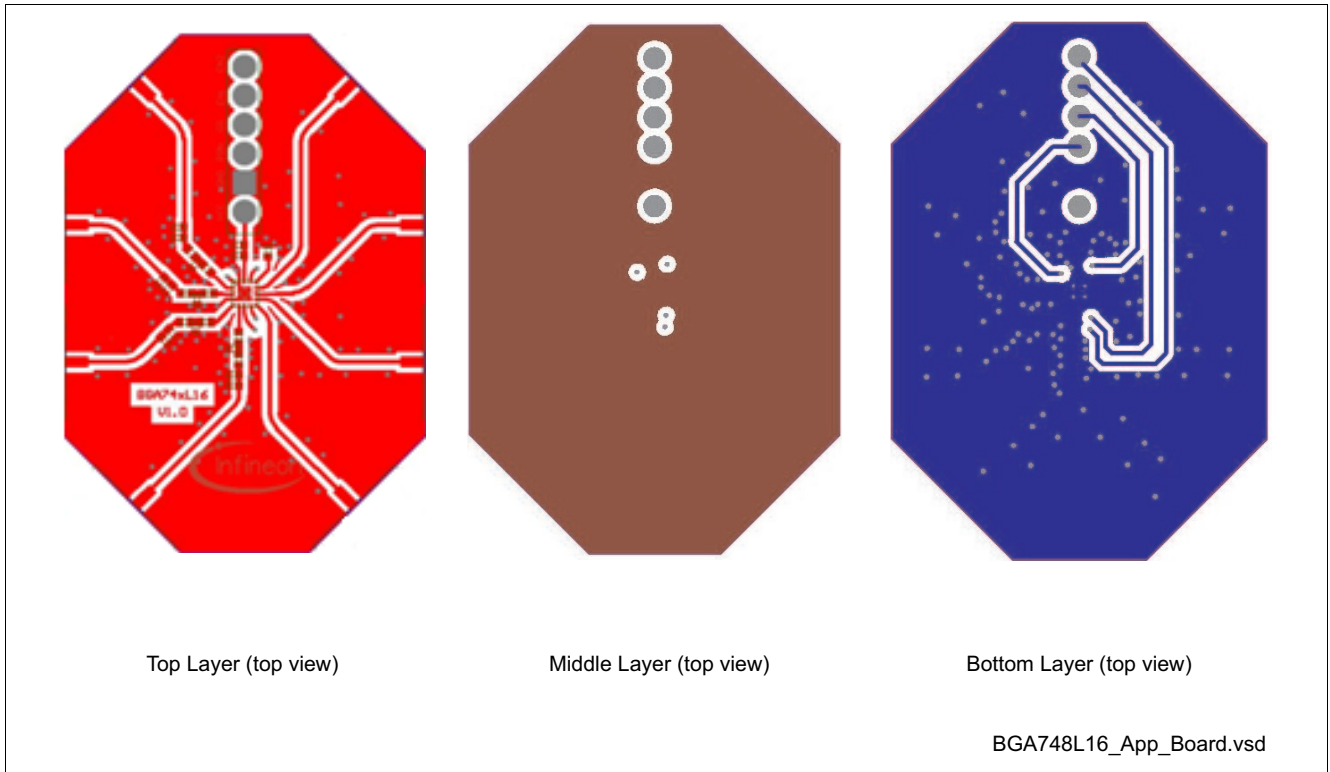

Note: Top layer thickness: 0.2 mm, bottom layer thickness: 0.8 mm, 17 mm Cu metallization, gold plated. Board size: 21 x 50 mm.

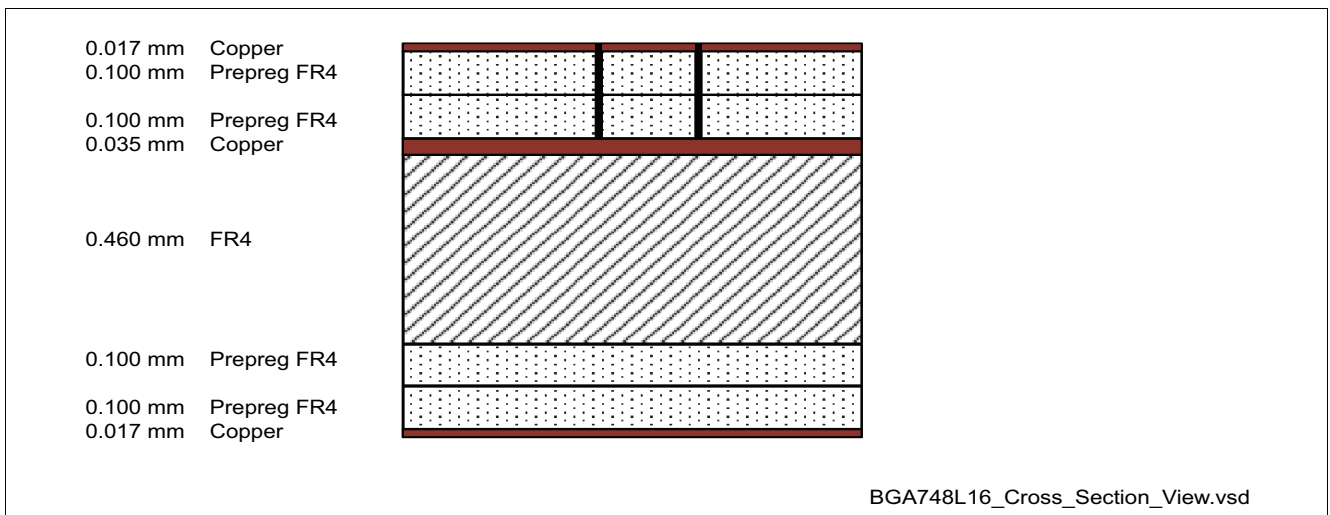

Figure 3 Cross-Section view of Application Board

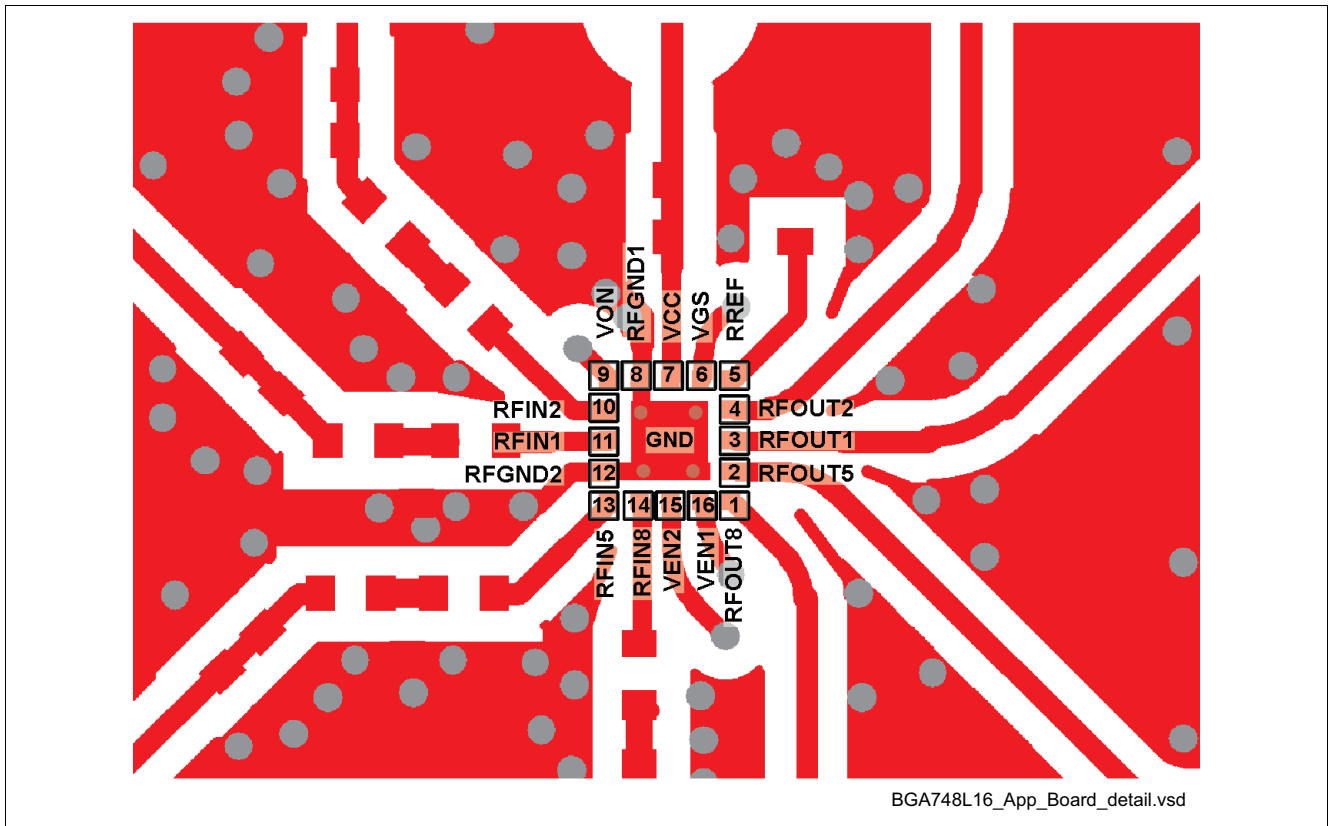

Figure 4 Detail of Application Board Layout

Note: In order to achieve the same performance as given in this datasheet please follow the suggested PCB-layout as closely as possible. The position of the GND vias is critical for RF performance.

4 Physical Characteristics

4.1 Package Footprint

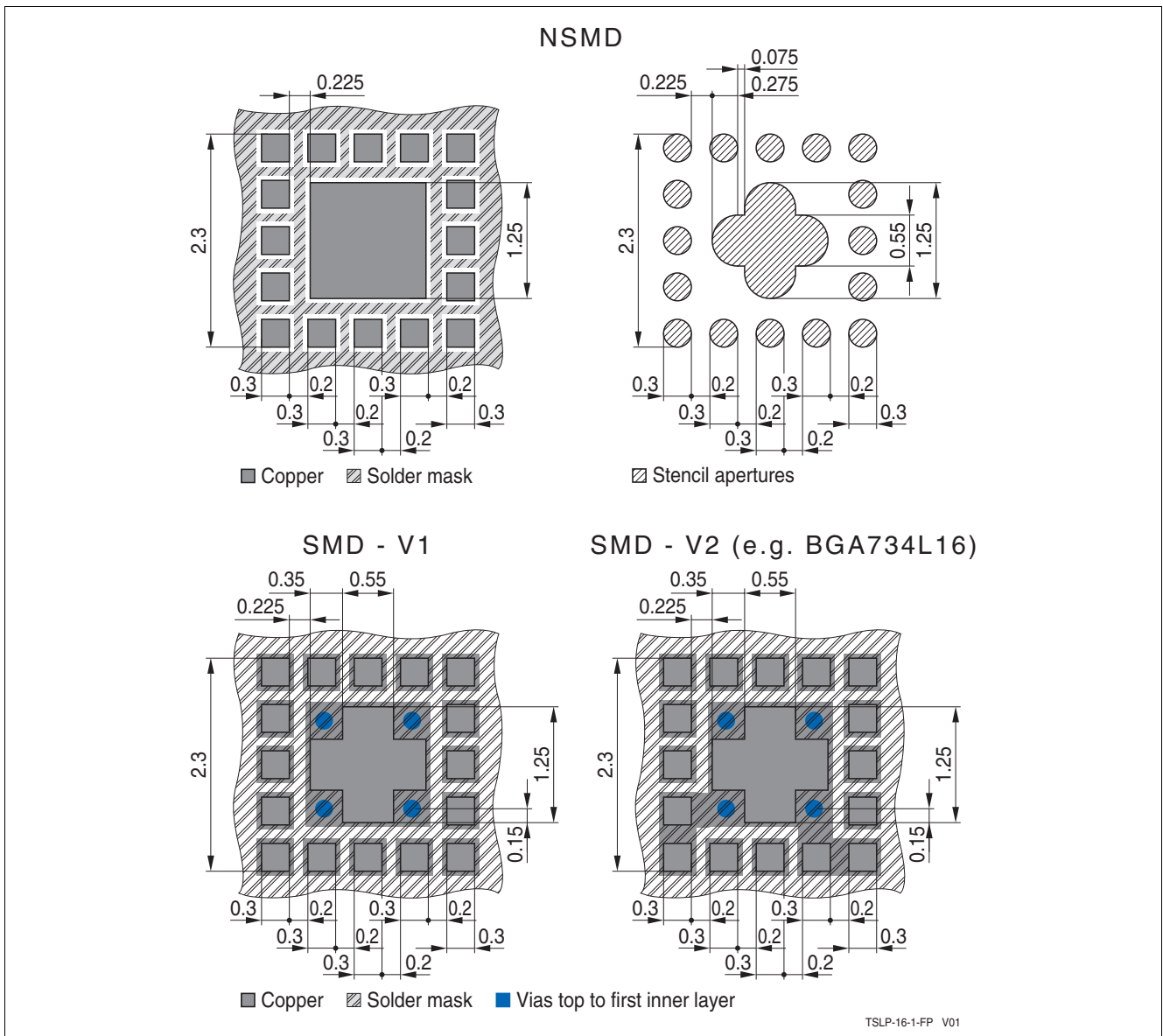

Figure 5 Recommended Footprint and Stencil Layout for the TSLP-16-1 Package

4.2 Package Dimensions

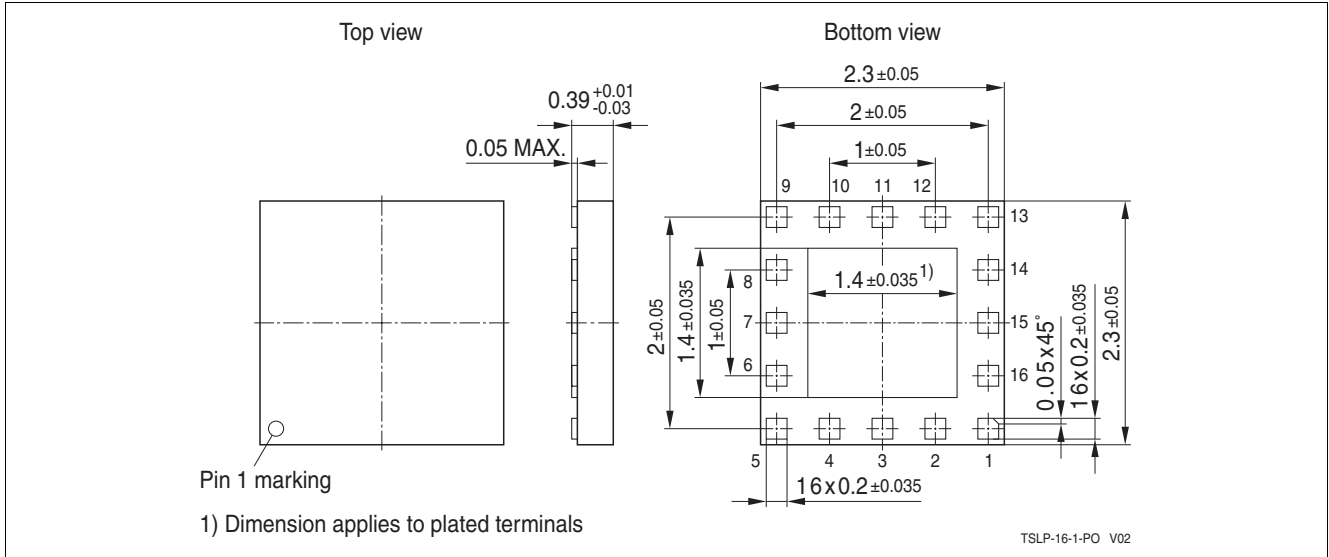



Figure 6 Package Outline (top, side and bottom view)

www.infineon.com

Published by Infineon Technologies AG

Looking for pricing, stock, or lifecycle information?

Click below to explore more details on WIN SOURCE:

-  [View BGA748L16E6327XTSA1 on WIN SOURCE](#)
-  [Infineon Technologies Information](#)

Optimize Your Supply Chain with WIN SOURCE Solutions

-  Global Sourcing Solution
-  Obsolete Management
-  Cost Control Management
-  Shortage Management
-  Alternative Solution
-  Excess Inventory Management