



**THE DATASHEET OF
BD2264G-MGTR**



1 Channel Compact High Side Switch ICs

Current Limit High Side Switch ICs

BD226xG-M Series

General Description

BD226xG-M series are low on-resistance N-channel MOSFET high-side power switches, optimized for Universal Serial Bus (USB) applications. BD226xG-M series are equipped with the function of over-current detection, thermal shutdown, under-voltage lockout and soft-start.

Features

- AEC-Q100 Qualified
- Over Current Protection
 - 0.3A: BD2262G-M
 - 0.76A: BD2264G-M / BD2265G-M
 - 0.97A: BD2266G-M / BD2267G-M
- Built-in Low ON-Resistance (Typ 120mΩ) N-Channel MOSFET
- Reverse Current Protection when Power Switch Off
- Thermal Shutdown
- Under-Voltage Lockout
- Open-Drain Error Flag Output
- Output Discharge Function
- Soft Start Circuit
- Control Input Logic
 - Active-High: BD2262G-M /BD2264G-M /BD2266G-M
 - Active-Low: BD2265G-M /BD2267G-M

Key Specifications

- Input Voltage Range: 2.7V to 5.5V
- ON-Resistance: 120mΩ(Typ)
- Over-Current Threshold: 0.3A, 0.76A, 0.97A
- Standby Current: 0.01μA (Typ)
- Operating Temperature Range: -40°C to +85°C

Package

W(Typ) D(Typ) H(Max)

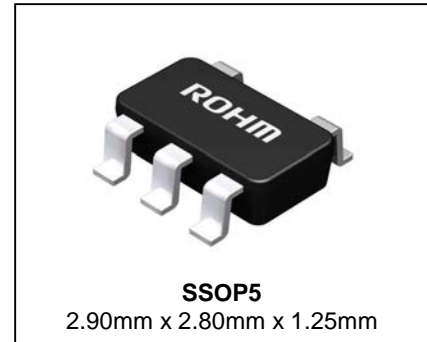

Applications

Car accessory, Industrial applications

Typical Application Circuit

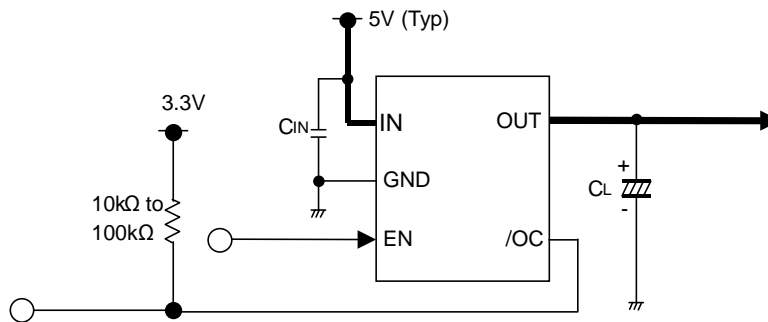

Lineup

Over-Current Threshold			Control Input Logic	Package		Orderable Part Number
Min	Typ	Max				
0.2A	0.3A	0.4A	High	SSOP5	Reel of 3000	BD2262G-MGTR
0.63A	0.76A	0.9A	High	SSOP5	Reel of 3000	BD2264G-MGTR
0.63A	0.76A	0.9A	Low	SSOP5	Reel of 3000	BD2265G-MGTR
0.82A	0.97A	1.12A	High	SSOP5	Reel of 3000	BD2266G-MGTR
0.82A	0.97A	1.12A	Low	SSOP5	Reel of 3000	BD2267G-MGTR

○Product structure : Silicon monolithic integrated circuit ○This product has not designed protection against radioactive rays

Block Diagram

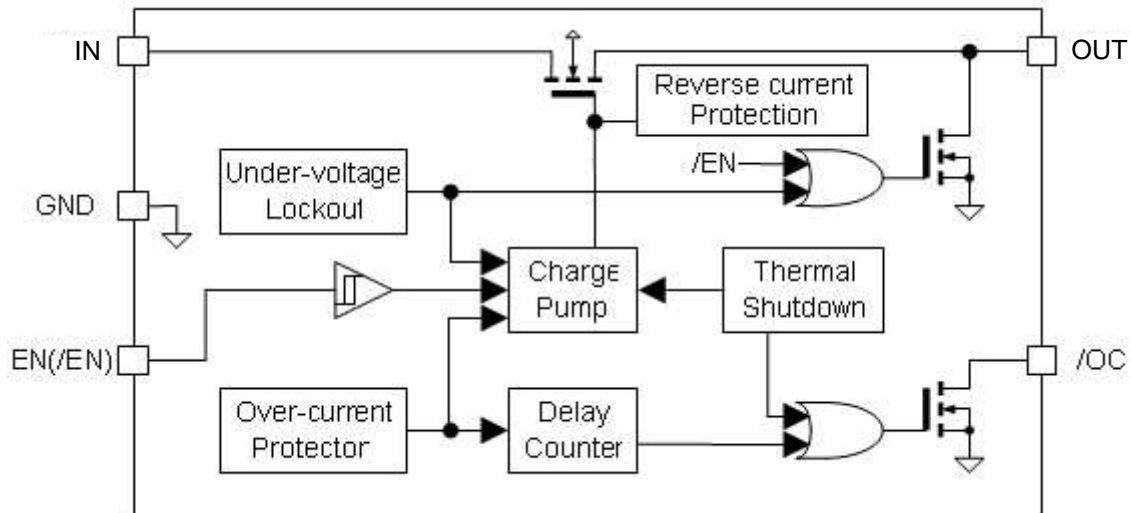

Pin Configurations

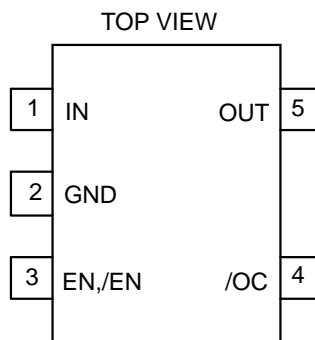

Pin Description

Pin No.	Symbol	I/O	Function
1	IN	-	Switch input and the supply voltage for the IC.
2	GND	-	Ground.
3	EN, /EN	I	Enable input. EN: High level input turns on the switch.(BD2262G-M, BD2264G-M, BD2266G-M) /EN: Low level input turns on the switch. (BD2265G-M, BD2267G-M)
4	/OC	O	Over-current detection terminal. Low level output during over-current or over-temperature condition. Open-drain fault flag output.
5	OUT	O	Switch output.

Absolute Maximum Ratings (Ta=25°C)

Parameter	Symbol	Rating	Unit
IN Supply Voltage	V _{IN}	-0.3 to +6.0	V
EN(/EN) Input Voltage	V _{EN} , V _{/EN}	-0.3 to +6.0	V
/OC Voltage	V _{/OC}	-0.3 to +6.0	V
/OC Sink Current	I _{/OC}	5	mA
OUT Voltage	V _{OUT}	-0.3 to +6.0	V
Storage Temperature	T _{stg}	-55 to +150	°C
Power Dissipation	P _d	0.67 ^(Note 1)	W

(Note 1) Mounted on 70mm x 70mm x 1.6mm glass epoxy board. Reduce 5.4mW per 1°C above 25°C

Caution: Operating the IC over the absolute maximum ratings may damage the IC. The damage can either be a short circuit between pins or an open circuit between pins and the internal circuitry. Therefore, it is important to consider circuit protection measures, such as adding a fuse, in case the IC is operated over the absolute maximum ratings.

Recommended Operating Conditions

Parameter	Symbol	Rating			Unit
		Min	Typ	Max	
IN Operating Voltage	V _{IN}	2.7	5.0	5.5	V
Operating Temperature	T _{opr}	-40	-	+85	°C

Electrical Characteristics

(V_{IN}= 5V, Ta= 25°C, unless otherwise specified.)

DC Characteristics

Parameter	Symbol	Limit			Unit	Conditions	
		Min	Typ	Max			
Operating Current	I _{DD}	-	135	175	μA	V _{EN} = 5V (BD2262G-M) V _{OUT} = open	
		-	110	160		V _{EN} = 5V (BD2264/ 66G-M) V _{/EN} = 0V (BD2265/ 67G-M) V _{OUT} = open	
Standby Current	I _{STB}	-	0.01	5	μA	V _{EN} = 0V (BD2262/ 64/ 66G-M) V _{/EN} = 5V (BD2265/ 67G-M) V _{OUT} = open	
EN Input Voltage	V _{ENH(/ENH)}	2.0	-	-	V	High Input, V _{IN} =3.3 to 5V	
	V _{ENL(/ENL)}	-	-	0.8	V	Low Input, V _{IN} =5V	
	V _{ENL(/ENL)}	-	-	0.6	V	Low Input, V _{IN} =3.3V	
EN Input Leakage	I _{EN(/EN)}	-1	+0.01	+1	μA	V _{EN(/EN)} = 0V or 5V	
ON-Resistance	R _{ON}	-	120	165	mΩ	V _{IN} =5V I _{OUT} = 100mA (BD2262G-M) I _{OUT} = 500mA (BD2264/ 65/ 66/ 67G-M)	
		-	140	190		V _{IN} =3.3V I _{OUT} = 100mA (BD2262G-M) I _{OUT} = 500mA (BD2264/ 65/ 66/ 67G-M)	
Reverse Leak Current	I _{REV}	-	-	1.0	μA	V _{OUT} = 5.0V, V _{IN} = 0V	
Over-Current Threshold	I _{TH}	200	300	400	mA	V _{IN} = 5V	
		190	290	390		V _{IN} = 3.3V	
		630	765	900	BD2264/ 65G-M	V _{IN} = 5V	
		600	740	890		V _{IN} = 3.3V	
		820	970	1120	BD2266/ 67G-M	V _{IN} = 5V	
		730	940	1110		V _{IN} = 3.3V	
Short Circuit Output Current	I _{SC}	100	200	300	mA	V _{IN} =3.3 to 5V V _{OUT} = 0V, RMS	
		350	500	650			BD2262G-M
		500	650	850			BD2264/ 65G-M BD2266/ 67G-M
Output Discharge Resistance	R _{DISC}	30	60	120	Ω	I _{DISC} = 1mA	
/OC Output Low Voltage	V _{/OC}	-	-	0.4	V	I _{/OC} = 0.5mA	
UVLO Threshold	V _{TUVH}	2.1	2.3	2.5	V	V _{IN} Increasing	
	V _{TUVL}	2.0	2.2	2.4	V	V _{IN} Decreasing	

AC Characteristics

Parameter	Symbol	Limit			Unit	Conditions
		Min	Typ	Max		
Output Rise Time	t_{ON1}	-	1	6	ms	BD2262G-M: $R_L = 500\Omega$ BD2264/ 65/ 66/ 67G-M: $R_L = 20\Omega$
Output Turn ON Time	t_{ON2}	-	1.5	10	ms	
Output Fall Time	t_{OFF1}	-	1	20	μs	
Output Turn OFF Time	t_{OFF2}	-	3	40	μs	
/OC Delay Time	$t_{/OC}$	10	15	20	ms	

Measurement Circuit

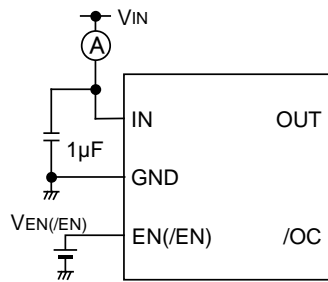

A. Operating Current

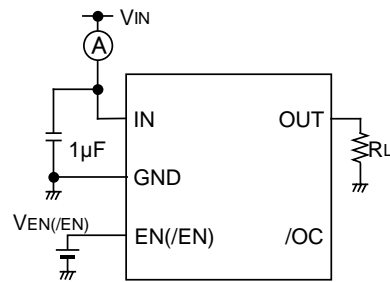

B. EN, /EN Input Voltage, Output Rise / Fall Time

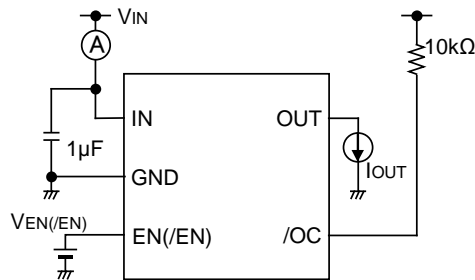

C. ON-Resistance, Over-Current Detection

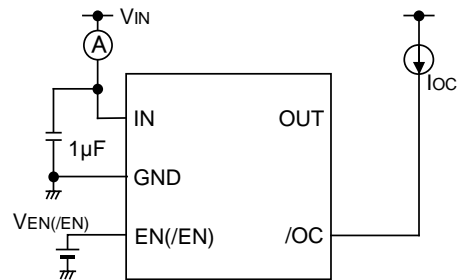

D. /OC Output Low Voltage

Figure 1. Measurement Circuit

Timing Diagram

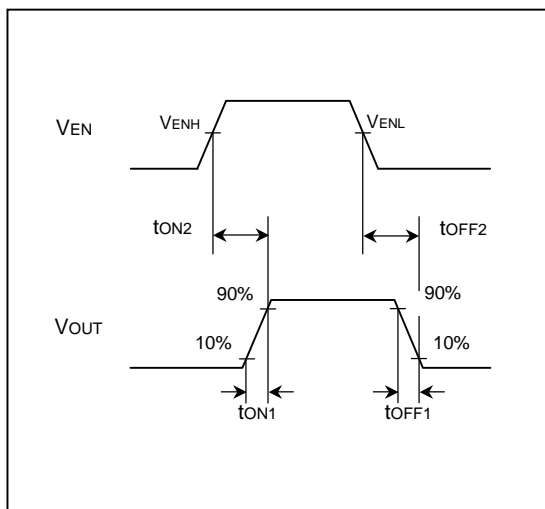

Figure 2. Output Rise / Fall Time (BD2262G-M, BD2264G-M, BD2266G-M)

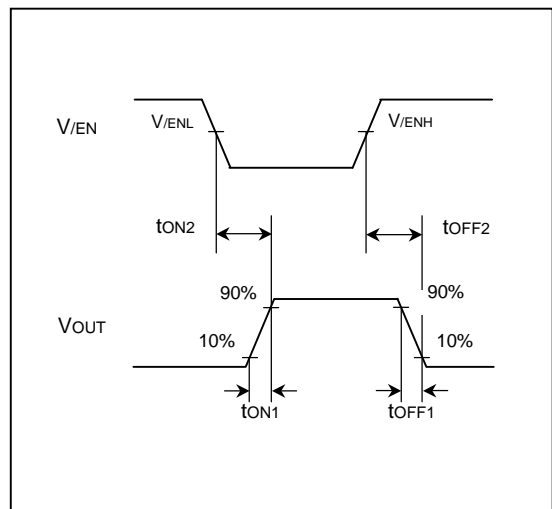

Figure 3. Output Rise / Fall Time (BD2265G-M, BD2267G-M)

Typical Performance Curves
(BD226xG-M)

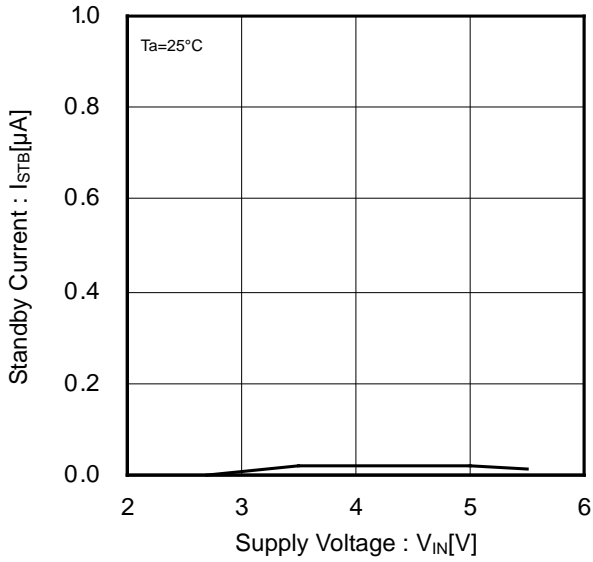

Figure 4. Standby Current vs Supply Voltage (EN, /EN Disable)

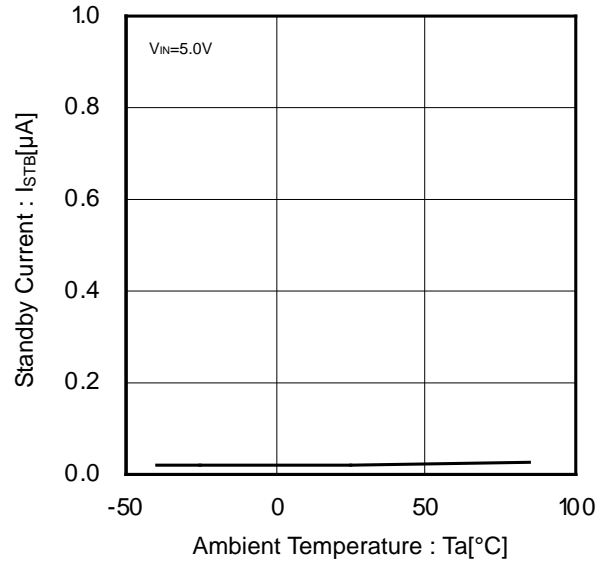

Figure 5. Standby Current vs Ambient Temperature (EN, /EN Disable)

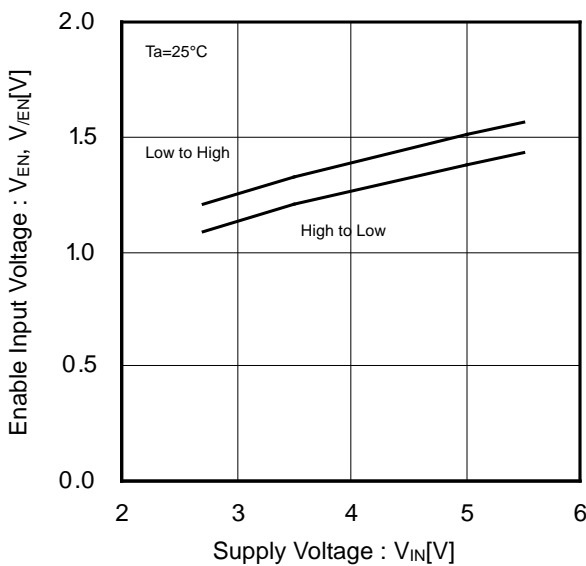

Figure 6. EN, /EN Input Voltage vs Supply Voltage (V_ENH, V_ENL, V_ENH, V_ENL)

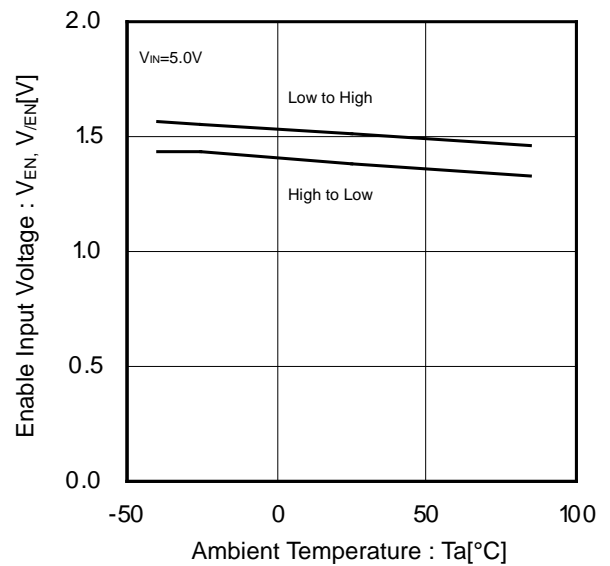

Figure 7. EN, /EN Input Voltage vs Ambient Temperature (V_ENH, V_ENL, V_ENH, V_ENL)

Typical Performance Curves - continued
(BD226xG-M)

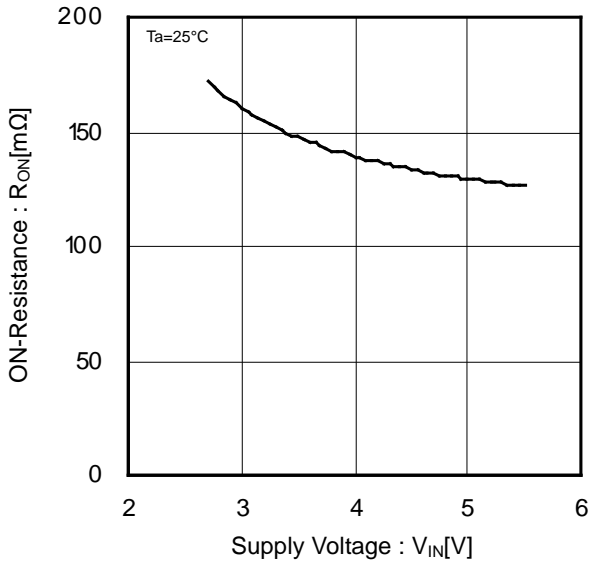

Figure 8. ON-Resistance vs Supply Voltage

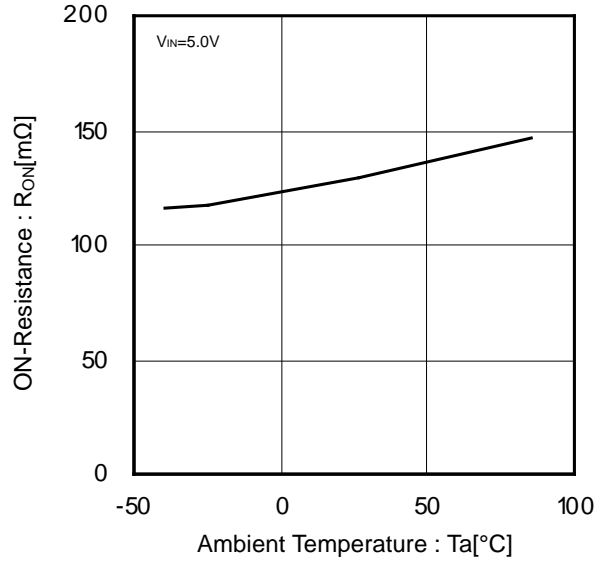

Figure 9. ON-Resistance vs Ambient Temperature

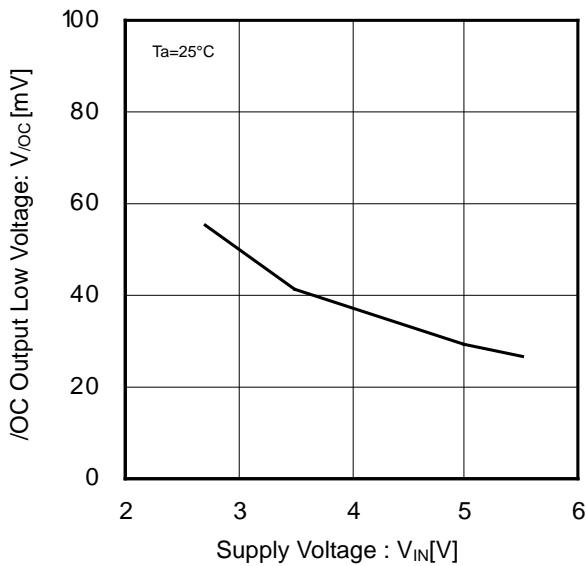

Figure 10. /OC Output Low Voltage vs Supply Voltage

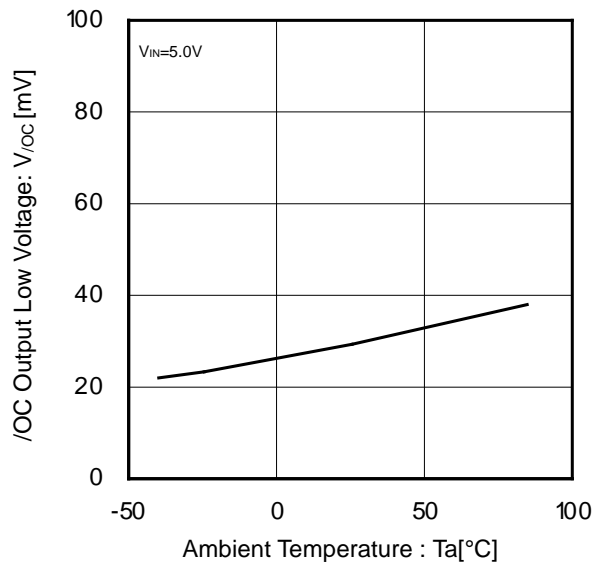

Figure 11. /OC Output Low Voltage vs Ambient Temperature

Typical Performance Curves - continued
(BD226xG-M)

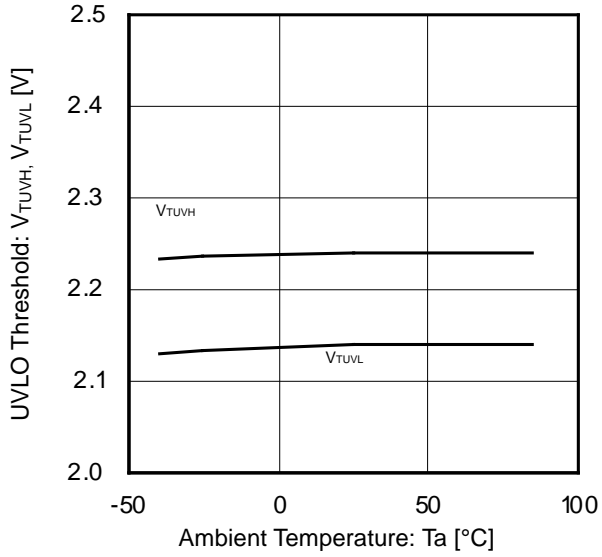

Figure 12. UVLO Threshold Voltage vs Ambient Temperature

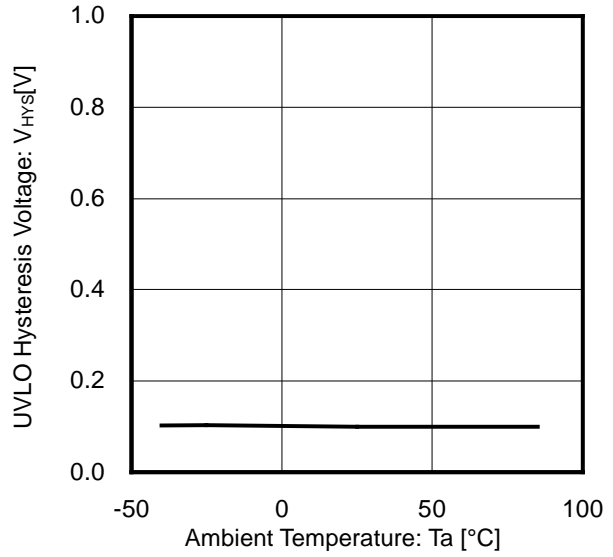

Figure 13. UVLO Hysteresis Voltage vs Ambient Temperature

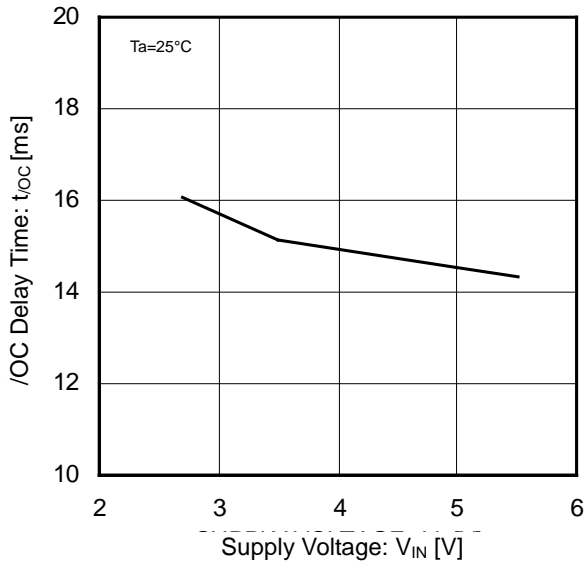

Figure 14. /OC Delay Time vs Supply Voltage

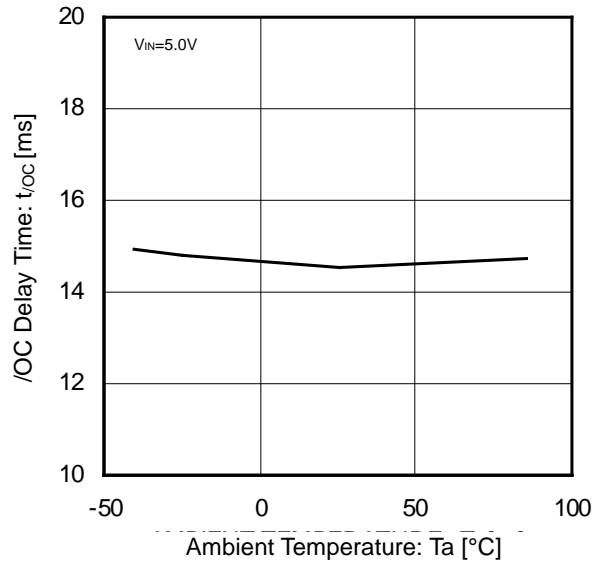

Figure 15. /OC Delay Time vs Ambient Temperature

Typical Performance Curves - continued
(BD226xG-M)

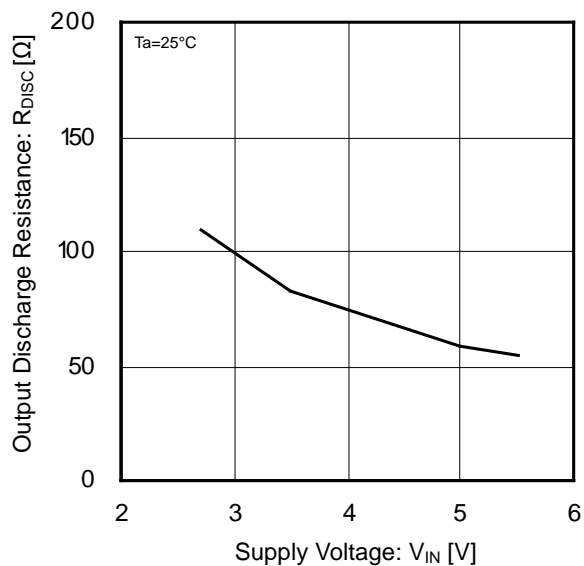

Figure 16. Output Discharge Resistance vs Supply Voltage

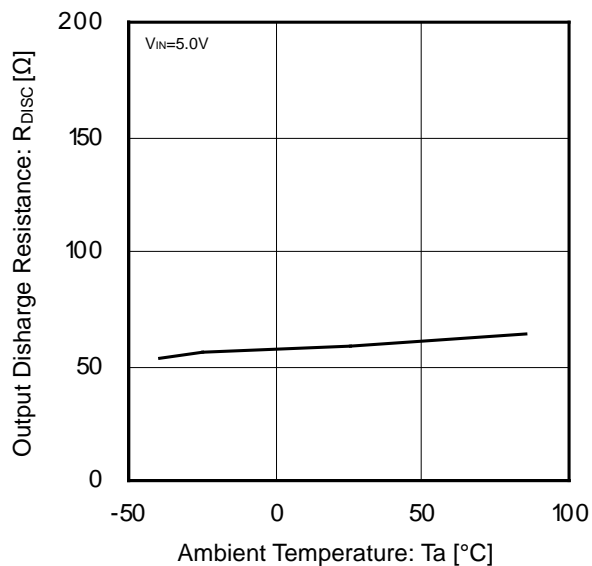

Figure 17. Output Discharge Resistance vs Ambient Temperature

Typical Performance Curves - continued
(BD2262G-M)

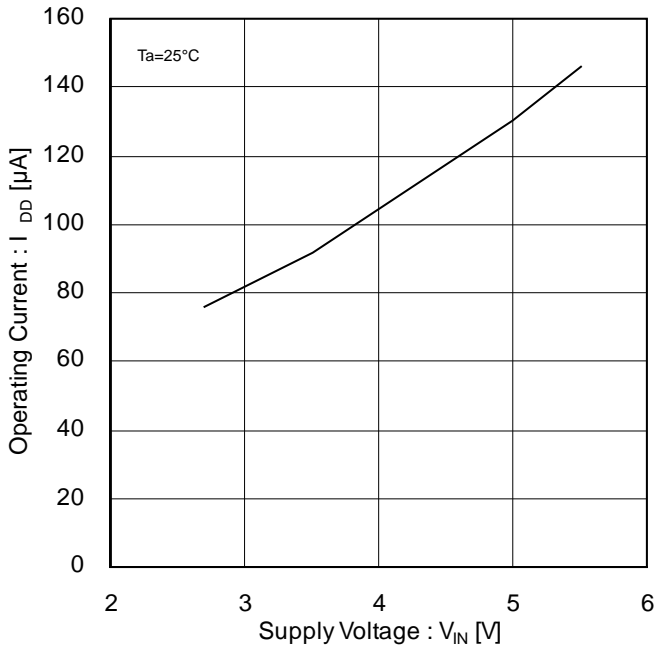

Figure 18. Operating Current vs Supply Voltage
EN Enable

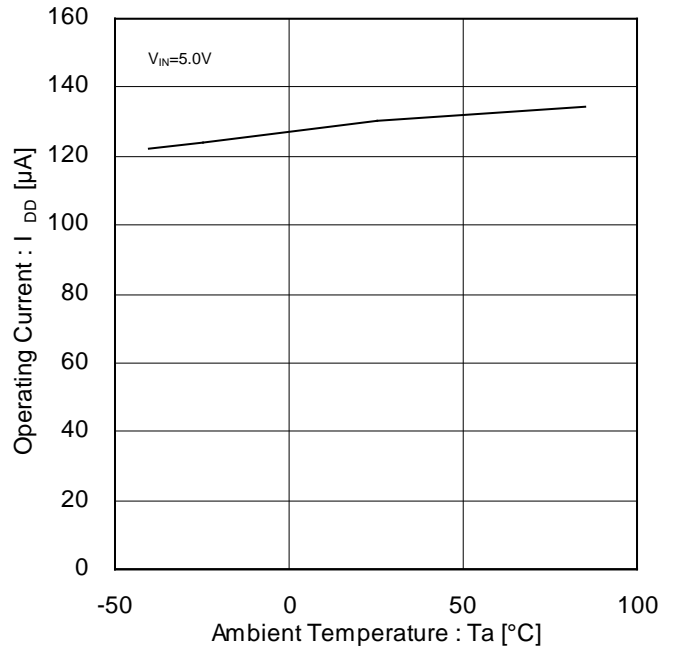

Figure 19. Operating Current vs Ambient
Temperature
EN Enable

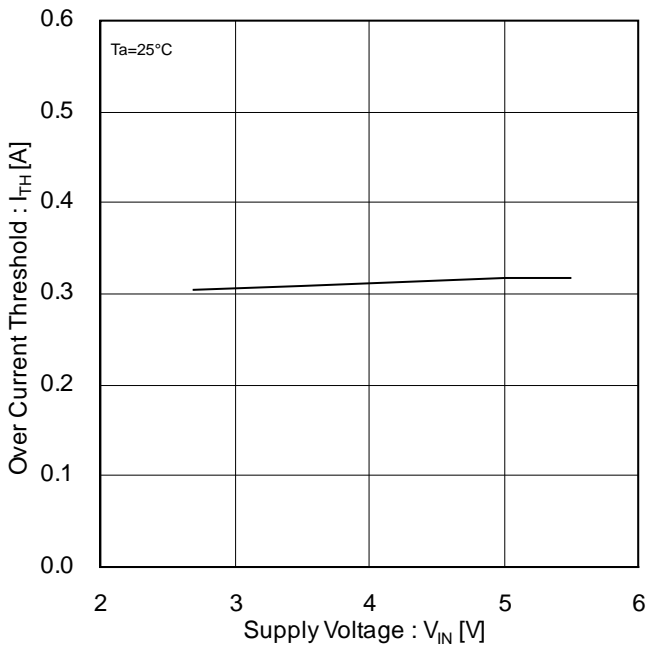

Figure 20. Over-Current Threshold vs
Supply Voltage

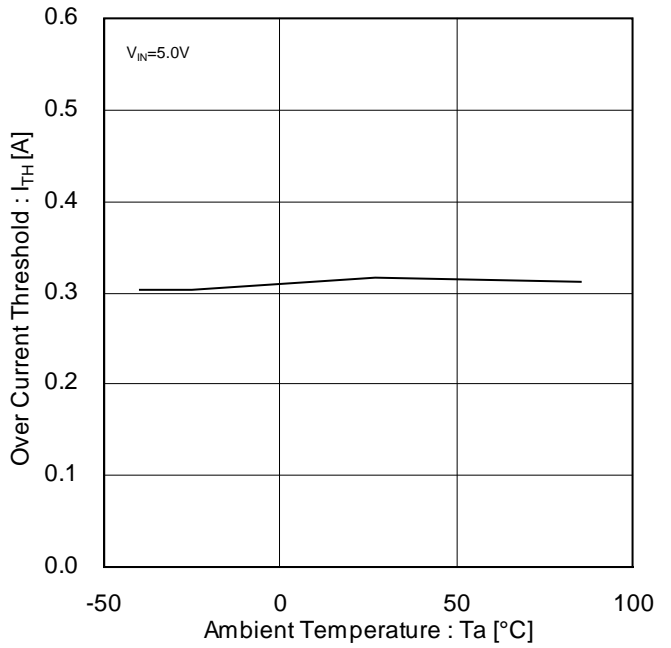

Figure 21. Over-Current Threshold vs
Ambient Temperature

Typical Performance Curves - continued
(BD2262G-M)

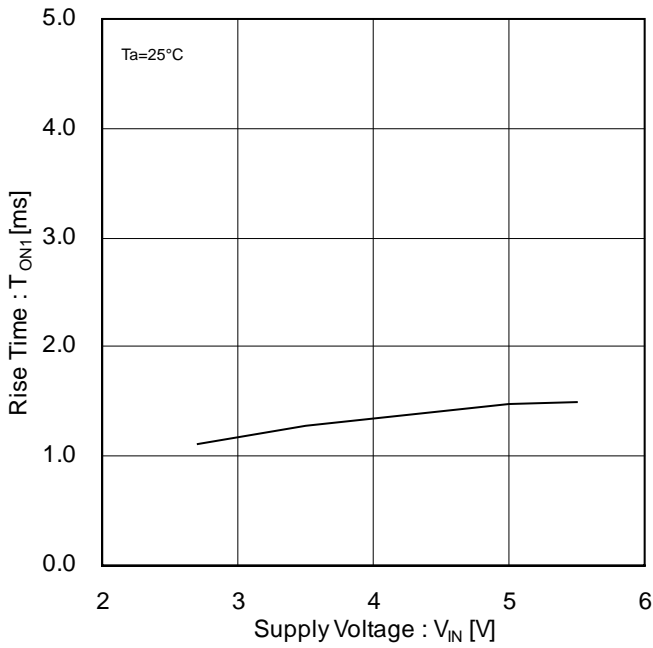

Figure 22. Output Rise Time vs Supply Voltage

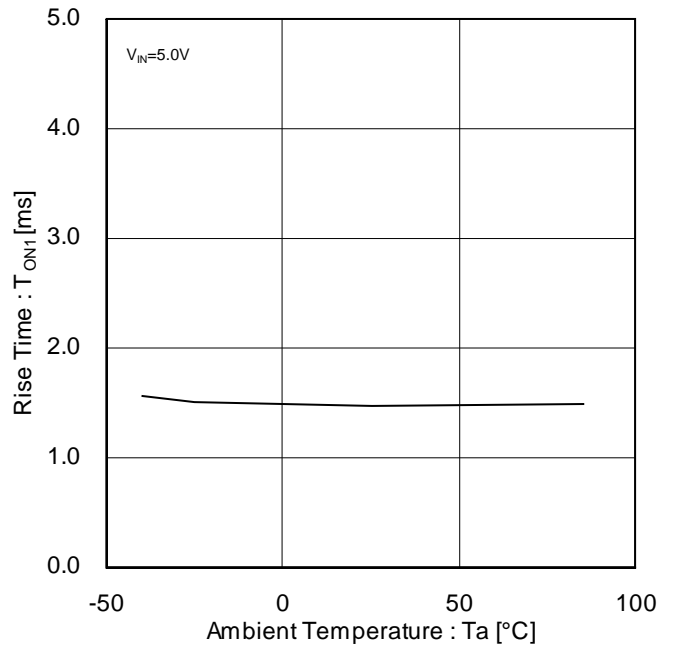

Figure 23. Output Rise Time vs Ambient Temperature

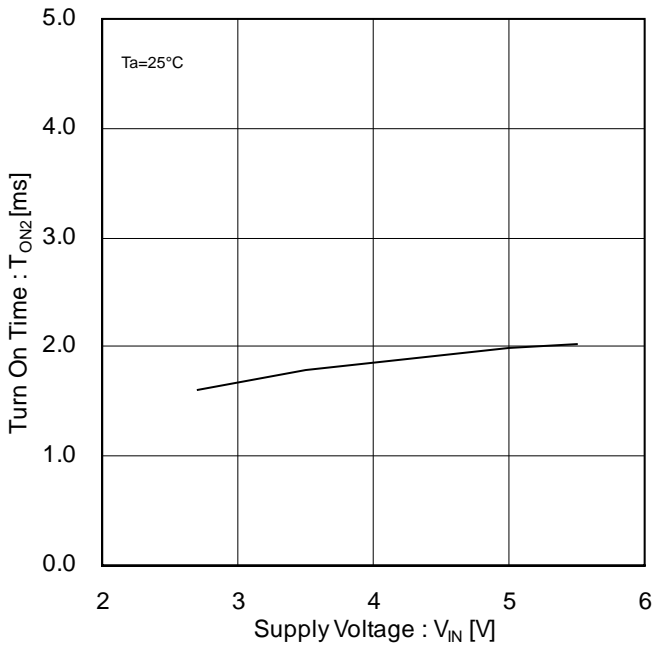

Figure 24. Output Turn-on Time vs Supply Voltage

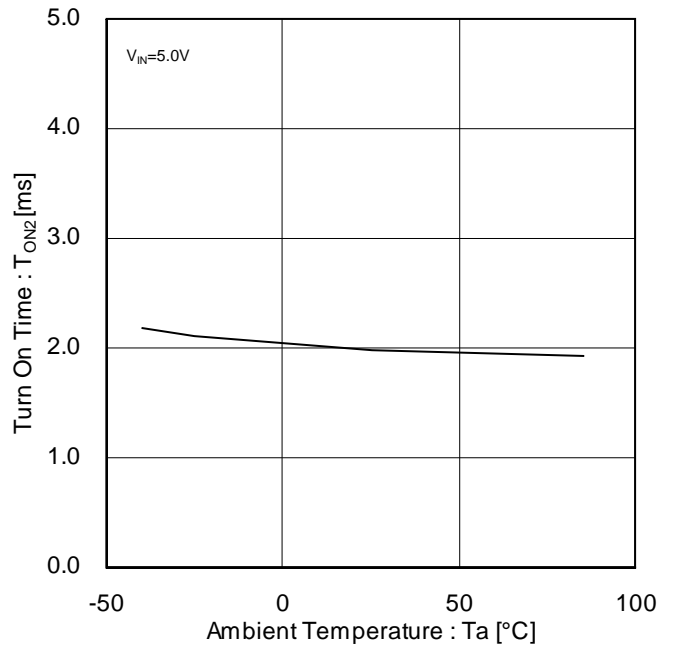

Figure 25. Output Turn-on Time vs Ambient Temperature

Typical Performance Curves - continued
(BD2262G-M)

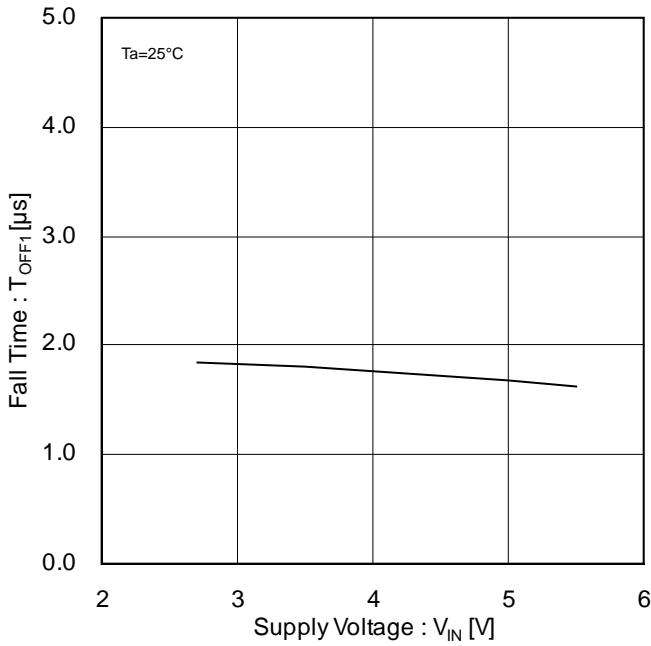

Figure 26. Output Fall Time vs Supply Voltage

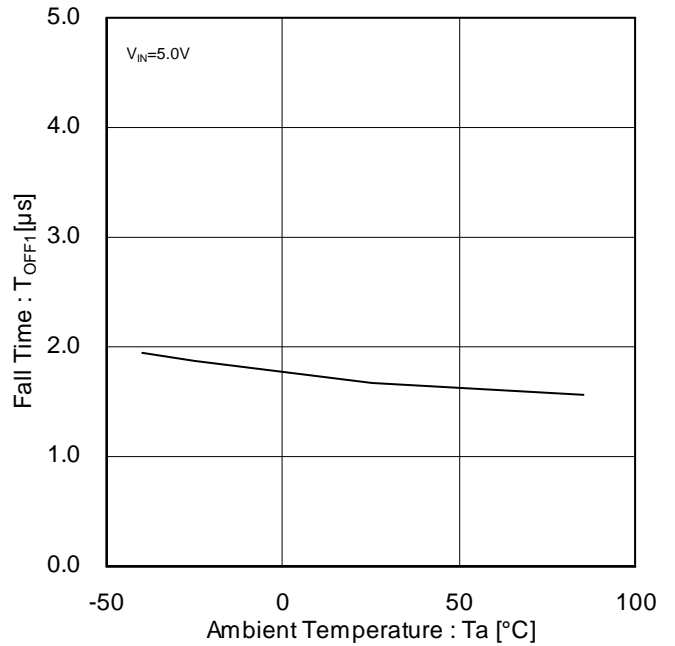

Figure 27. Output Fall Time vs Ambient Temperature

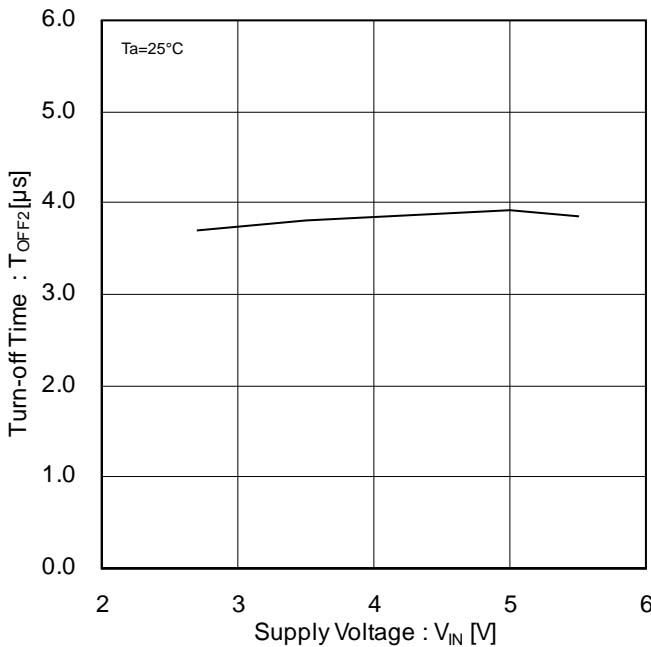

Figure 28. Output Turn-off Time vs Supply Voltage

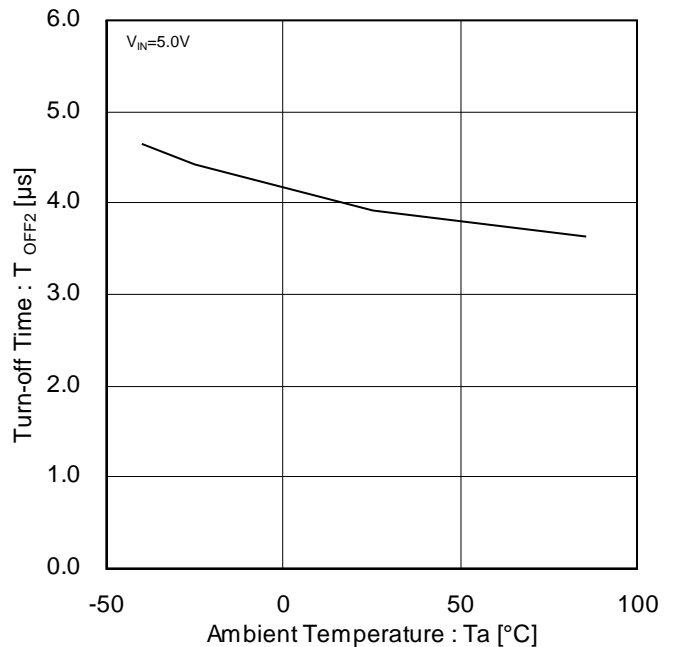

Figure 29. Output Turn-off Time vs Ambient Temperature

Typical Performance Curves - continued
 (BD2264G-M, BD2265G-M)

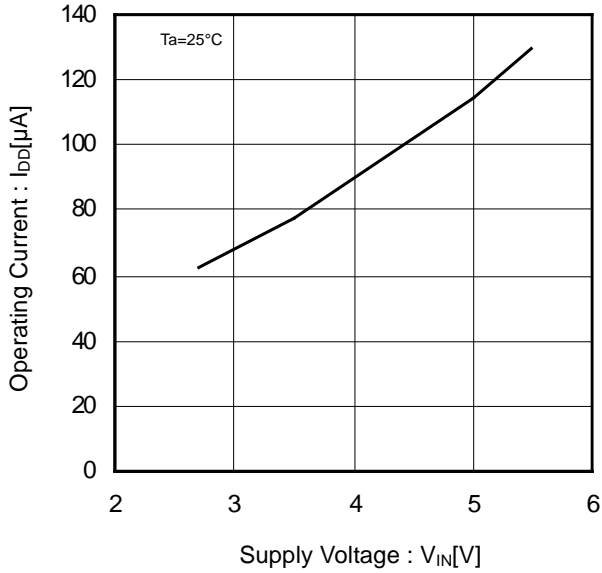

Figure 30. Operating Current vs Supply Voltage (EN, /EN Enable)

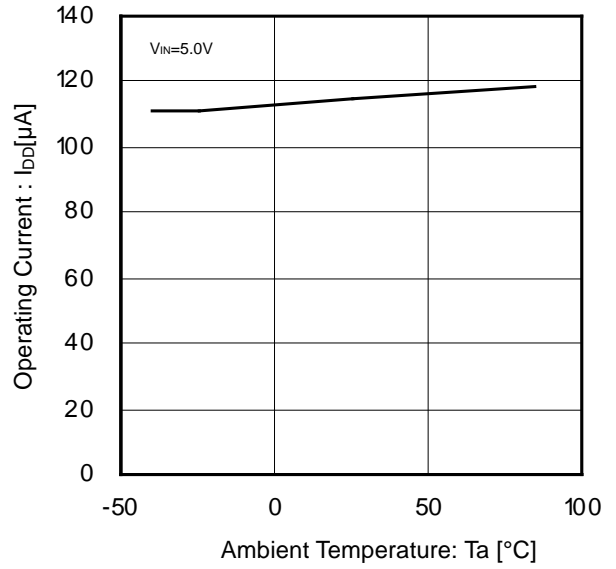

Figure 31. Operating Current vs Ambient Temperature (EN, /EN Enable)

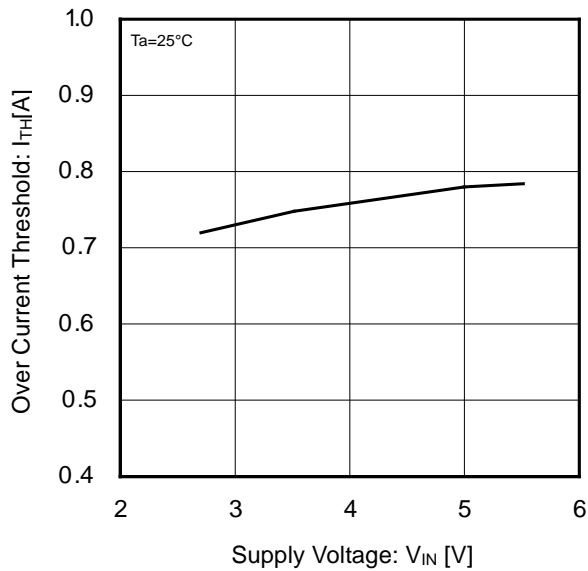

Figure 32. Over-Current Threshold vs Supply Voltage

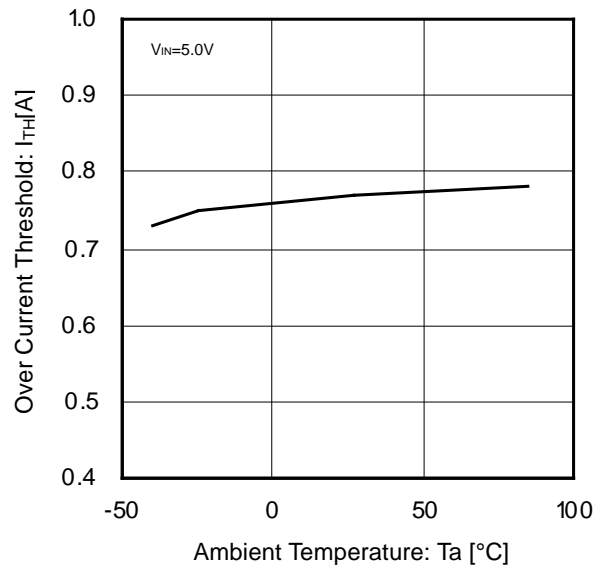

Figure 33. Over-Current Threshold vs Ambient Temperature

Typical Performance Curves - continued
 (BD2264G-M, BD2265G-M)

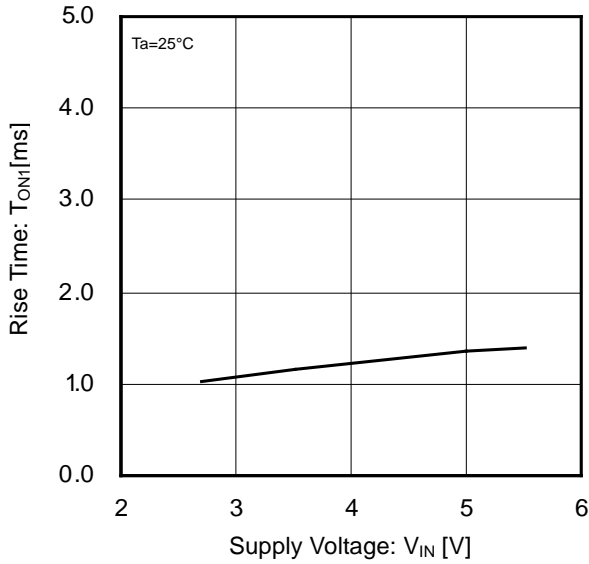

Figure 34. Output Rise Time vs Supply Voltage

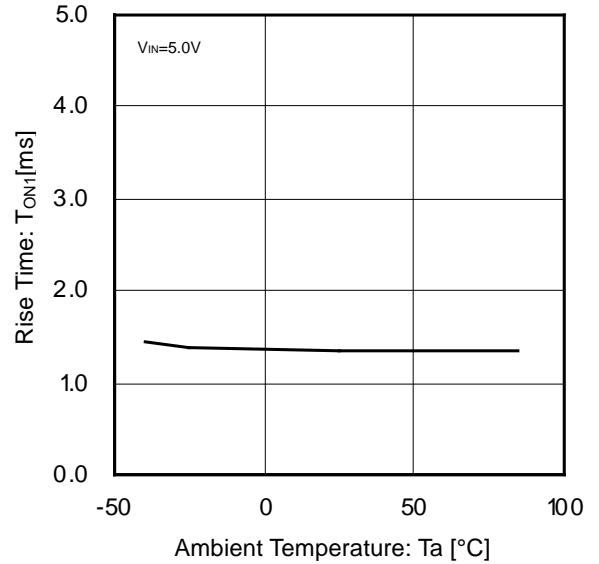

Figure 35. Output Rise Time vs Ambient Temperature

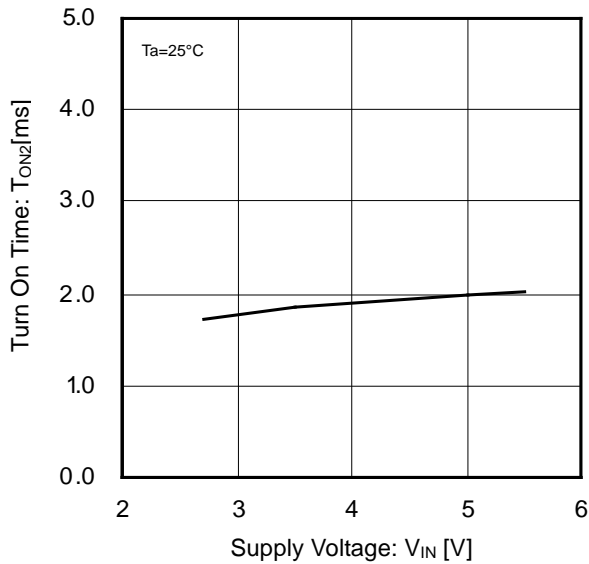

Figure 36. Output Turn-On Time vs Supply Voltage

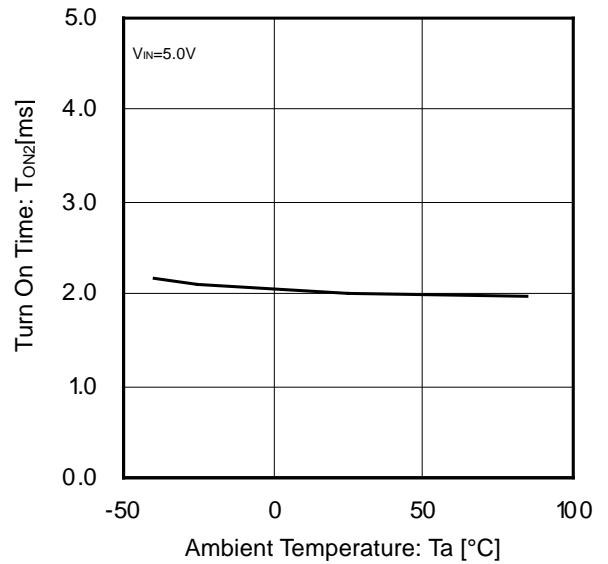

Figure 37. Output Turn-On Time vs Ambient Temperature

Typical Performance Curves - continued
(BD2264G-M, BD2265G-M)

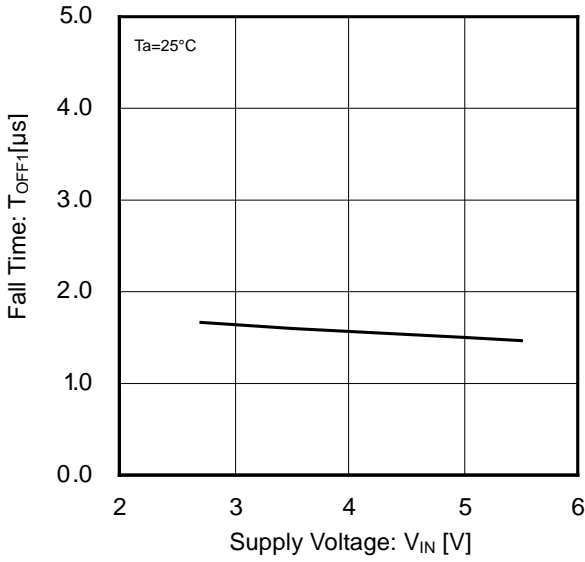

Figure 38. Output Fall Time vs Supply Voltage

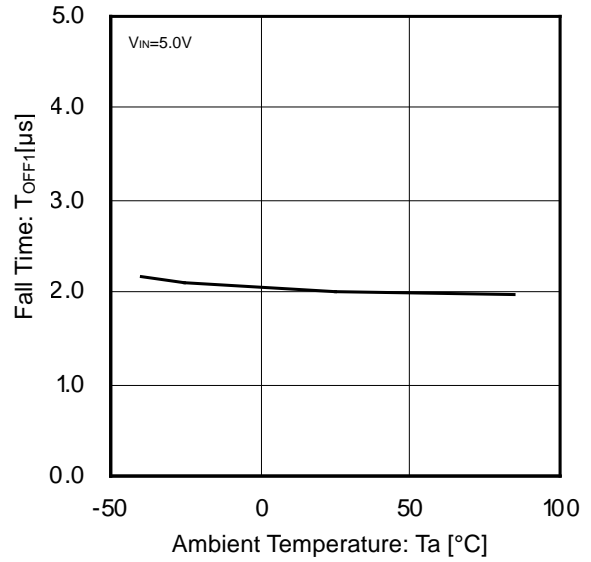

Figure 39. Output Fall Time vs Ambient Temperature

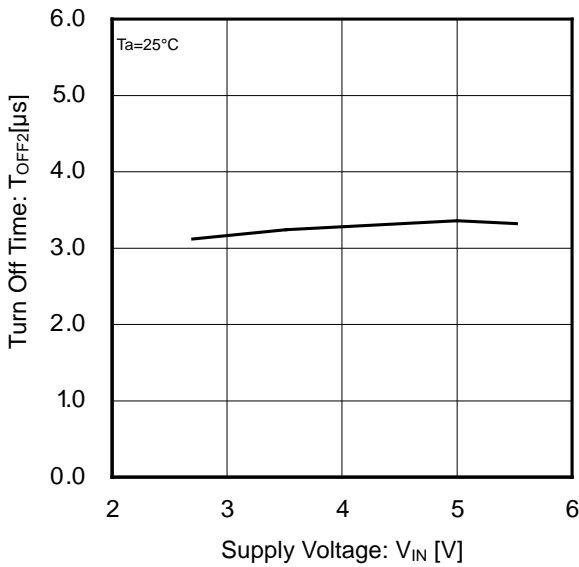

Figure 40. Output Turn-Off Time vs Supply Voltage

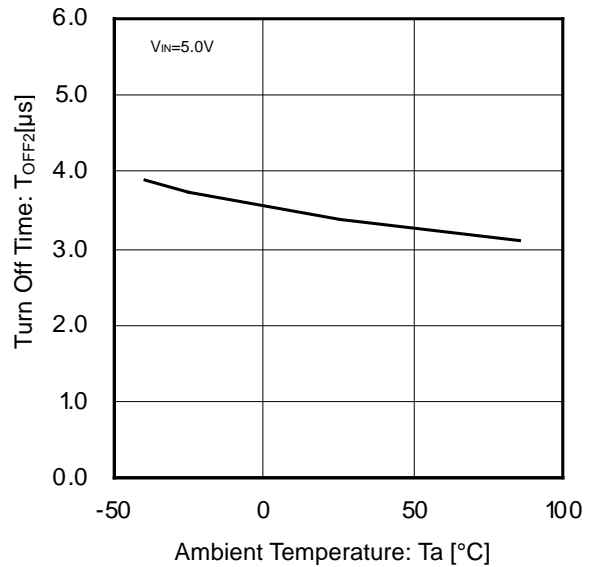

Figure 41. Output Turn-Off Time vs Ambient Temperature

Typical Performance Curves - continued
(BD2266G-M, BD2267G-M)

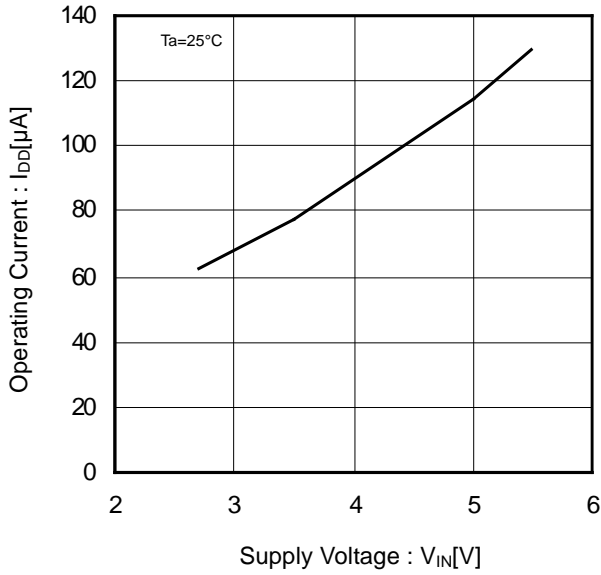

Figure 42. Operating Current vs Supply Voltage (EN, /EN Enable)

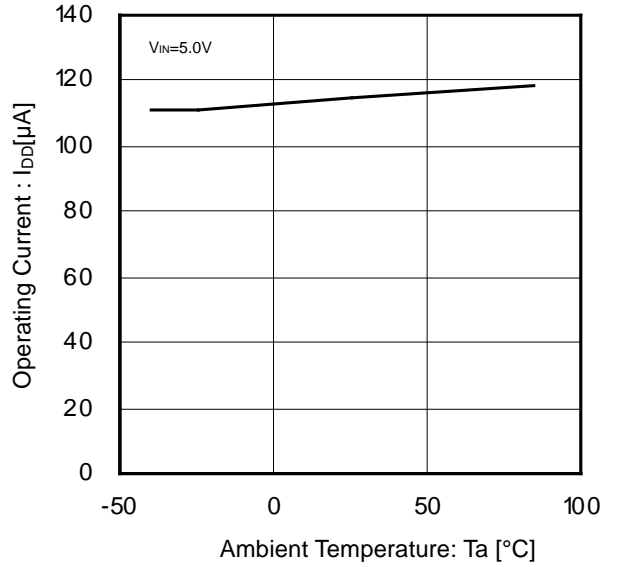

Figure 43. Operating Current vs Ambient Temperature (EN, /EN Enable)

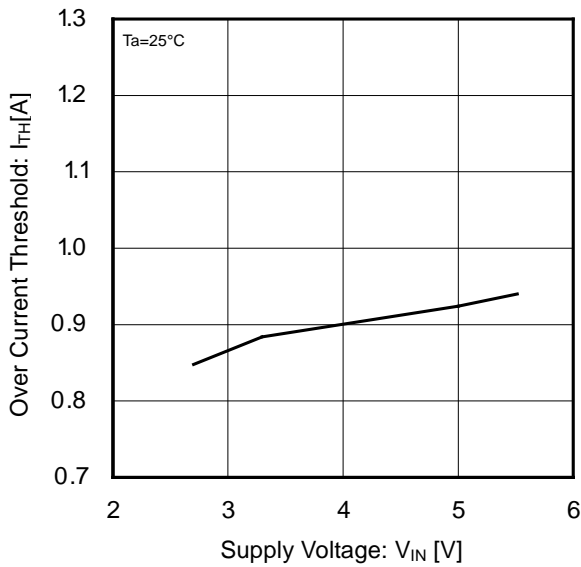

Figure 44. Over-current threshold vs Supply Voltage

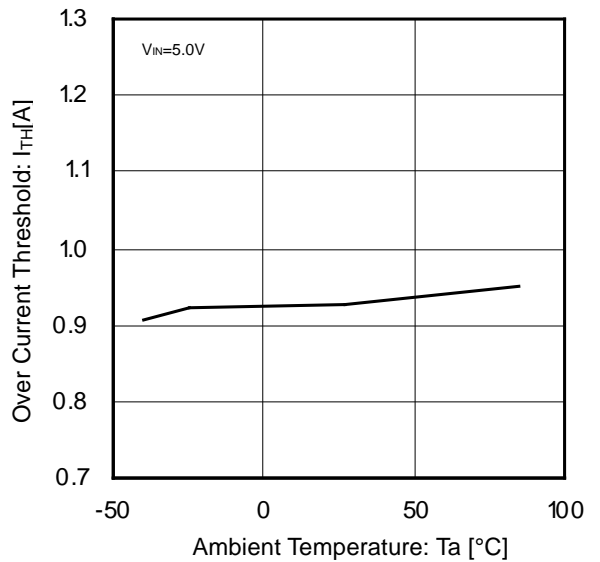

Figure 45. Over-current threshold vs Ambient Temperature

Typical Performance Curves - continued
 (BD2266G-M, BD2267G-M)

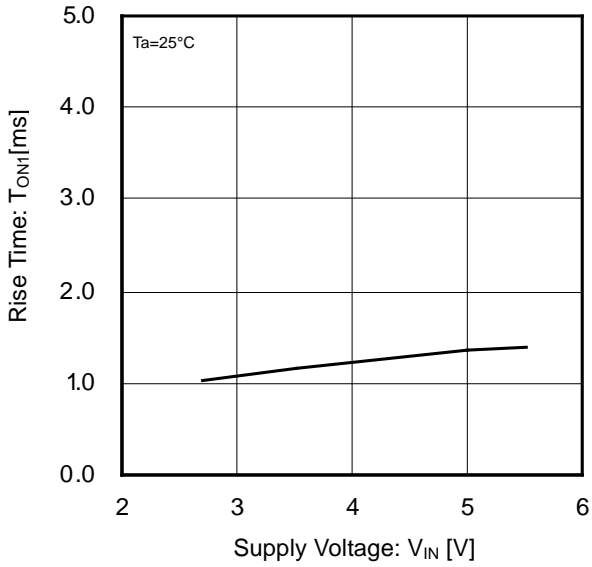

Figure 46. Output rise time vs Supply Voltage

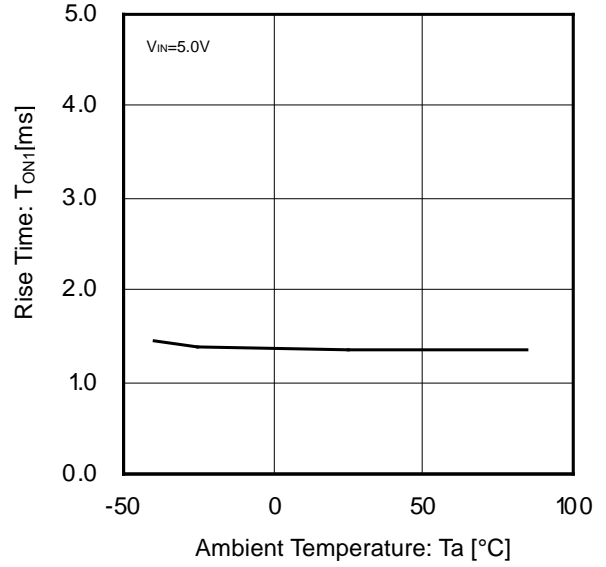

Figure 47. Output rise time vs Ambient Temperature

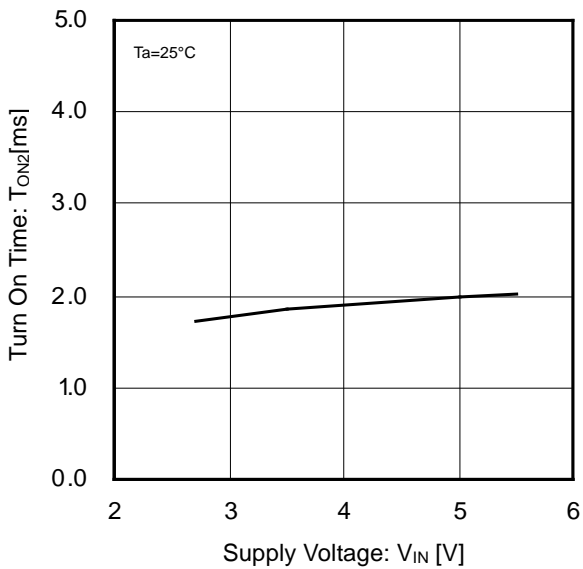

Figure 48. Output turn-on time vs Supply Voltage

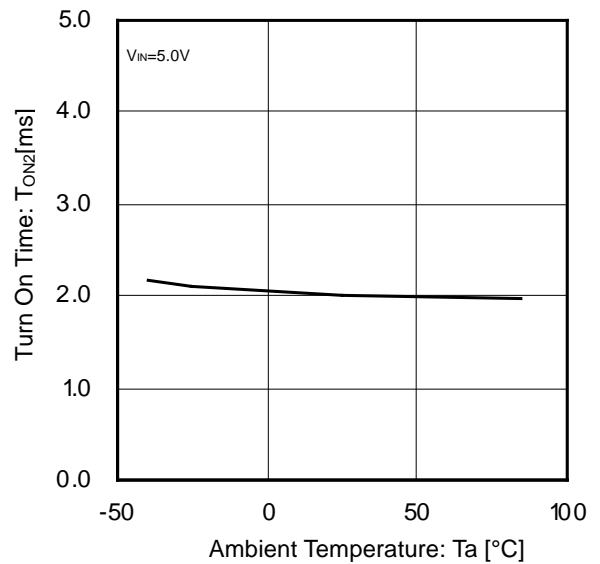

Figure 49. Output turn-on time vs Ambient Temperature

Typical Performance Curves - continued
(BD2266G-M, BD2267G-M)

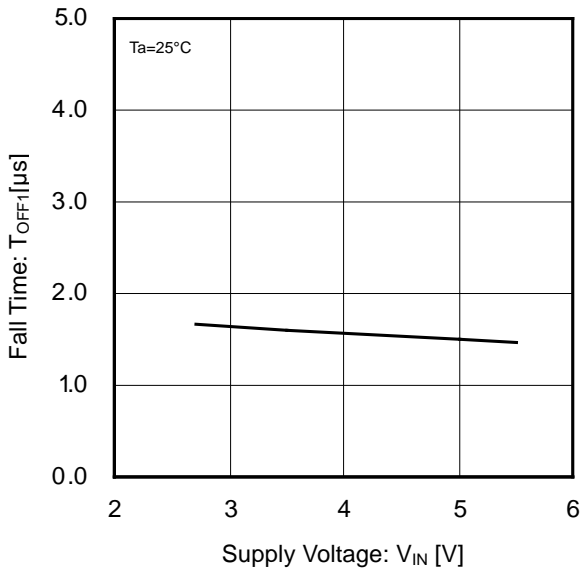

Figure 50. Output fall time vs Supply Voltage

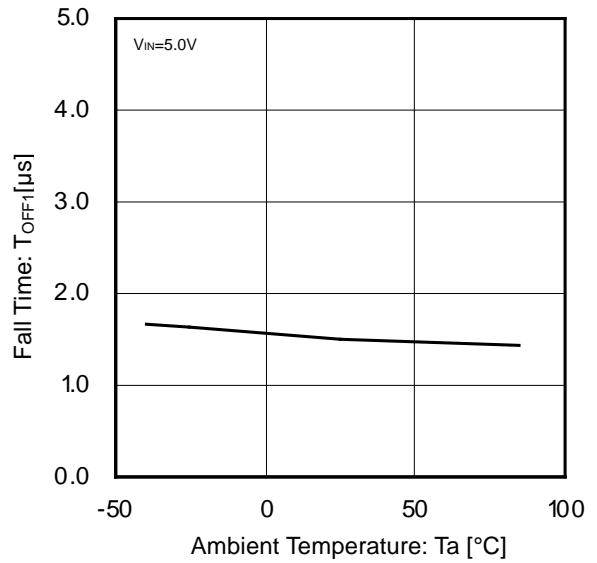

Figure 51. Output fall time vs Ambient Temperature

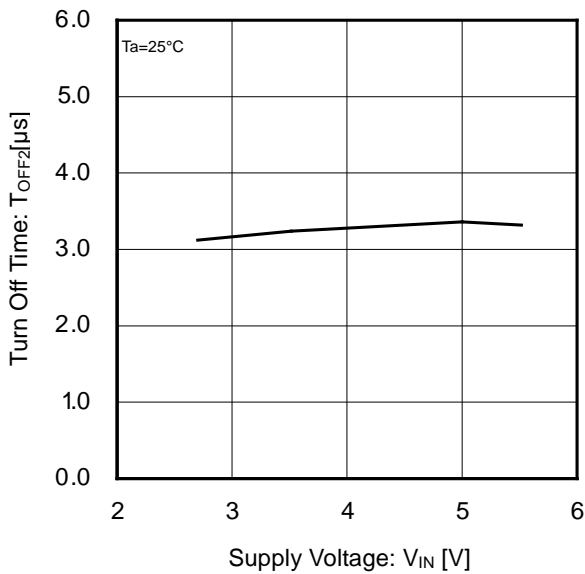

Figure 52. Output turn-off time vs Supply Voltage

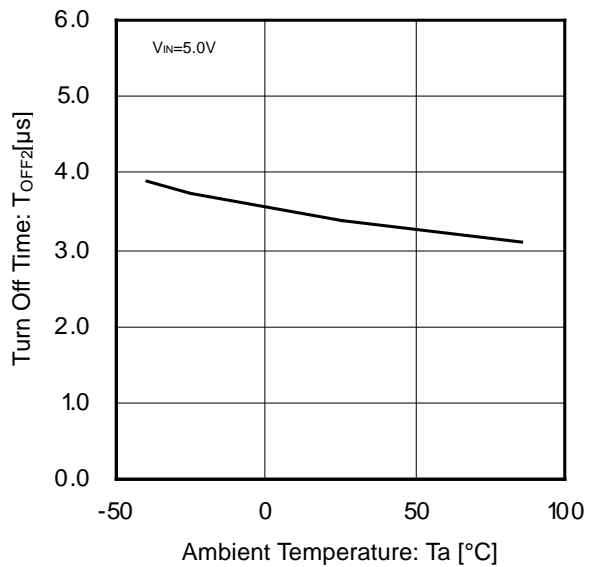
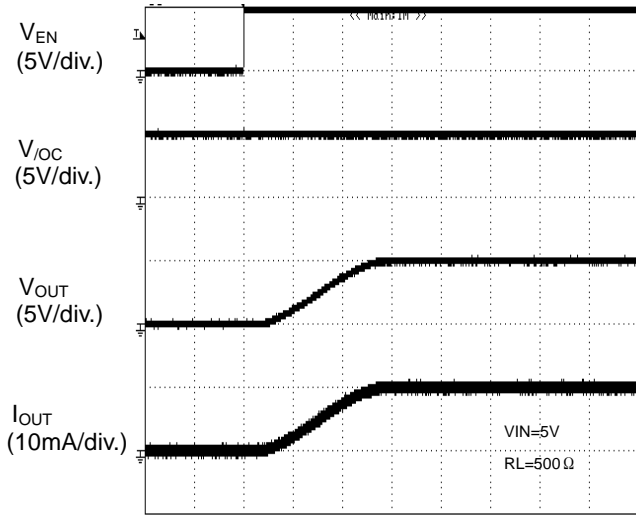
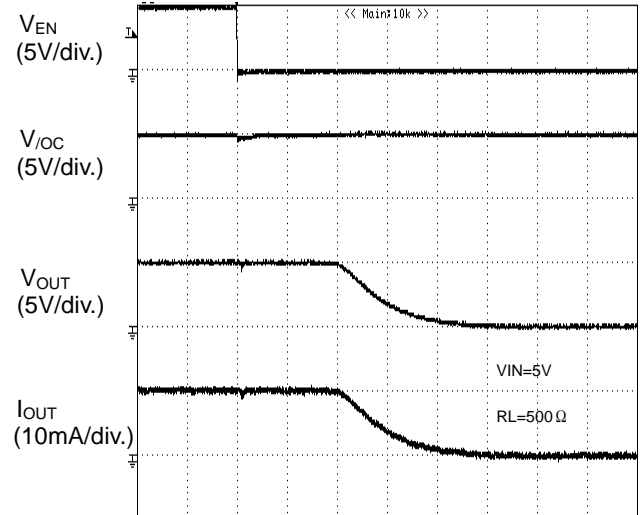

Figure 53. Output turn-off time vs Ambient Temperature

Typical Wave Forms
(BD2262G-M)



TIME (1ms/div.)
Figure 54. Output Rise Characteristic



TIME (1us/div.)
Figure 55. Output Fall Characteristic

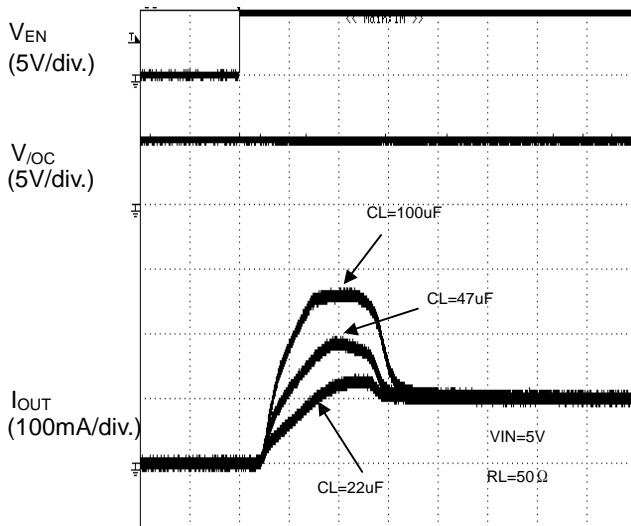

TIME (1ms/div.)
Figure 56. Inrush Current Response

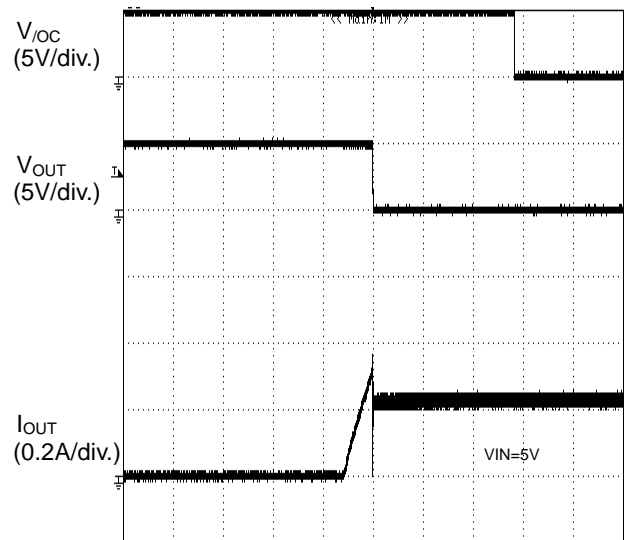

TIME (5ms/div.)
Figure 57. Over-Current Response Ramped Load

Typical Wave Forms – continued
(BD2262G-M)

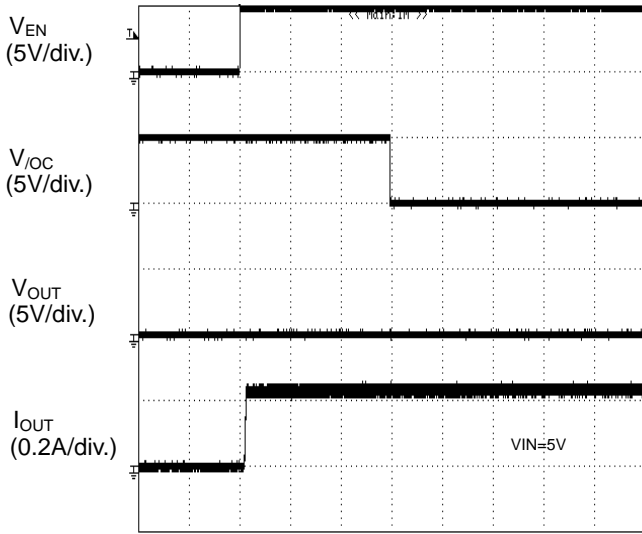

TIME (5ms/div.)
Figure 58. Over-Current Response
Enable to Shortcircuit

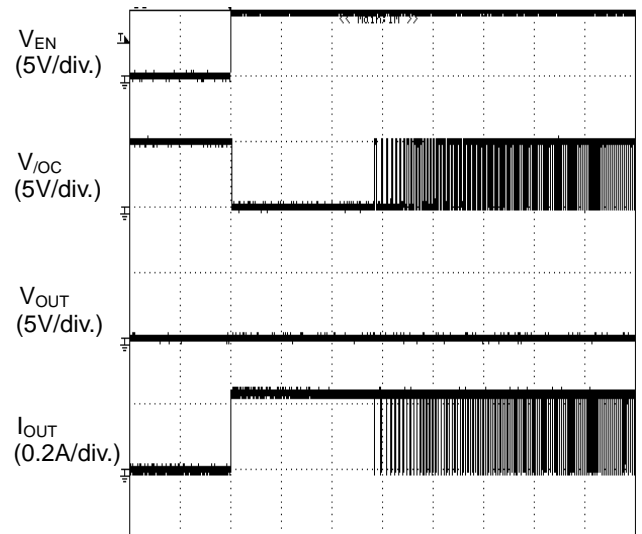

TIME (500ms/div.)
Figure 59. Over-Current Response
Enable to Shortcircuit

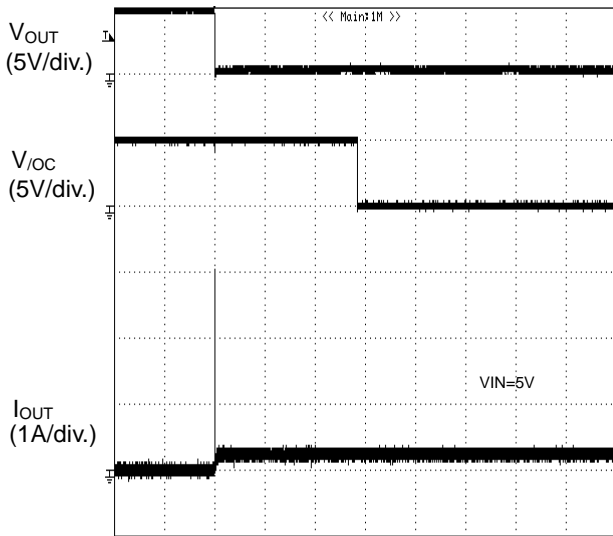

TIME (5ms/div.)
Figure 60. Over-Current Response
1Ω Load to Enabled Device

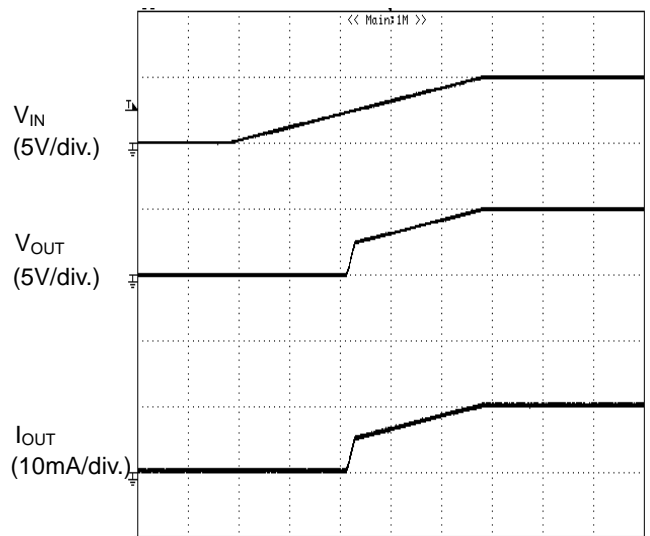

TIME (5ms/div.)
Figure 61. UVLO Response
Increasing V_{IN}

Typical Wave Forms – continued
 (BD2262G-M)

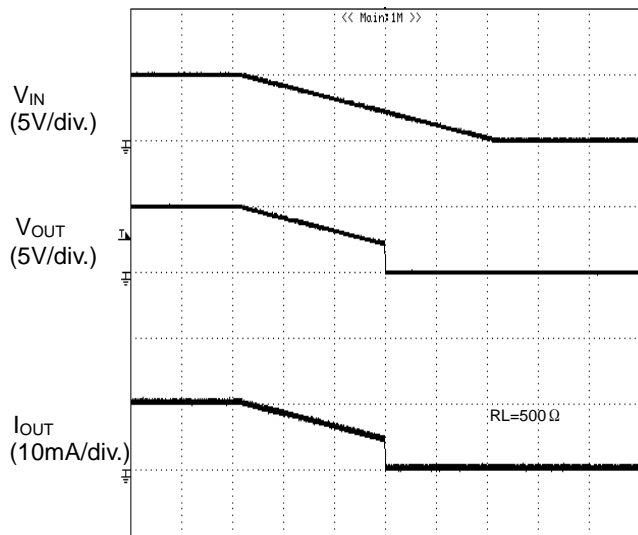

TIME (10ms/div.)
 Figure 62. UVLO Response
 Decreasing V_{IN}

Typical Wave Forms – continued
(BD2264G-M)

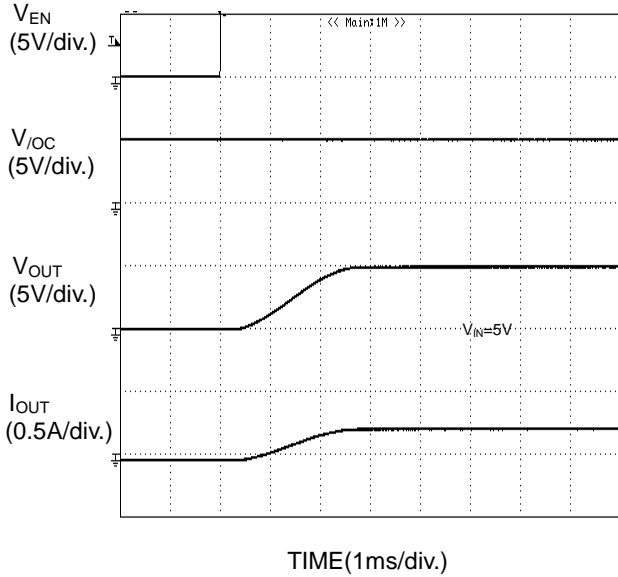

Figure 63. Output Rise Characteristic

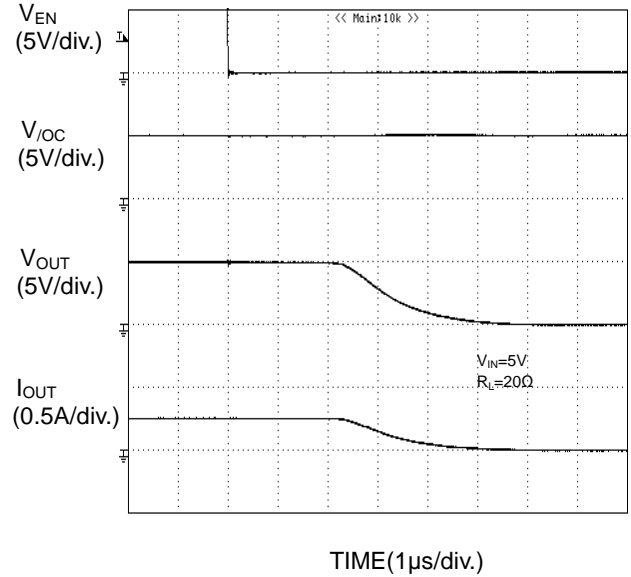

Figure 64. Output Fall Characteristic

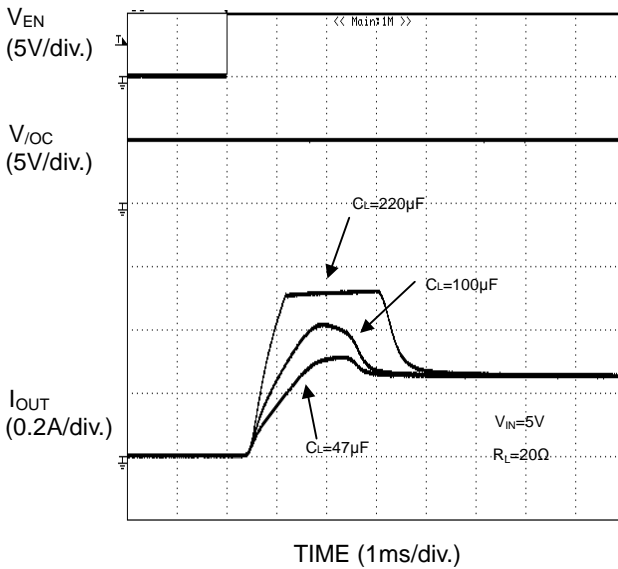

Figure 65. Inrush Current Response

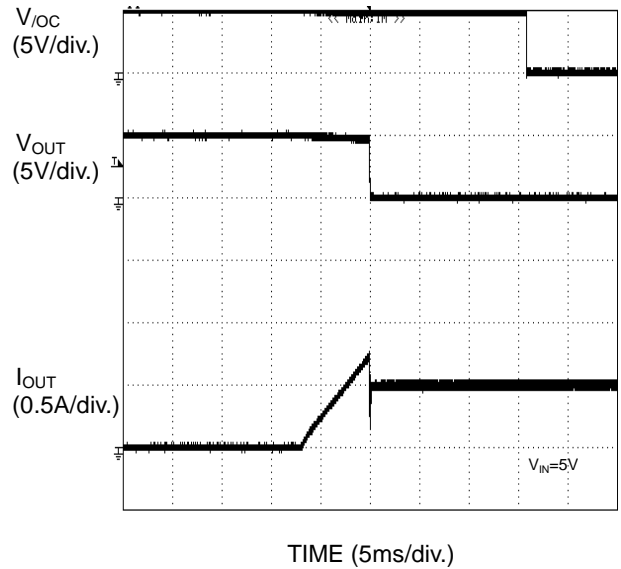

Figure 66. Over-Current Response Ramped Load

Typical Wave Forms – continued
(BD2264G-M)

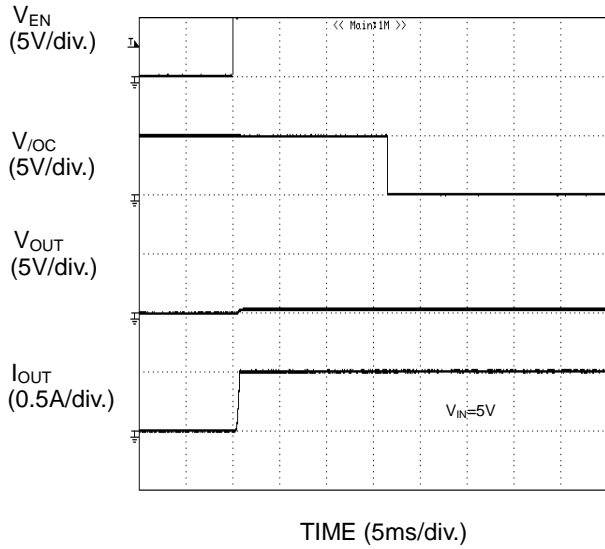

Figure 67. Over-Current Response Enable to Short Circuit

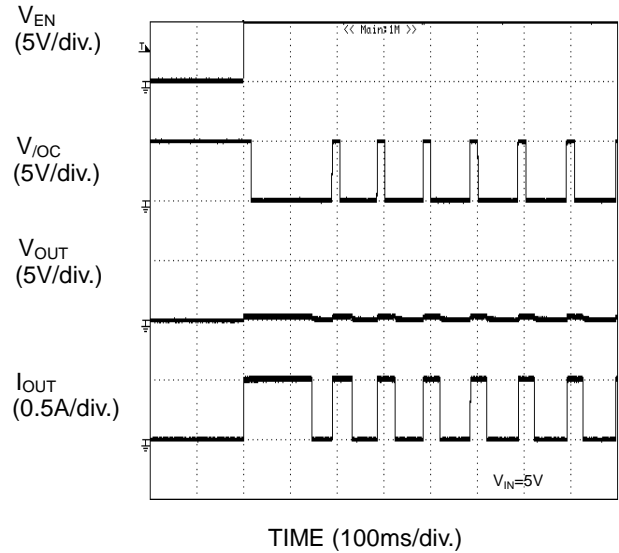

Figure 68. Over-Current Response Enable to Short Circuit

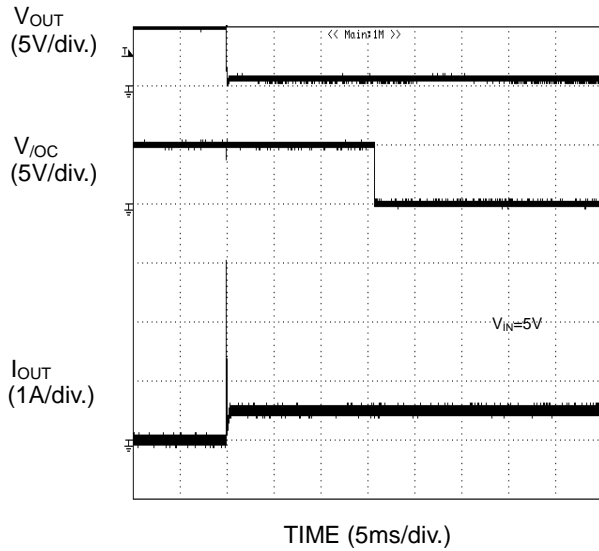

Figure 69. Over-Current Response 1Ω Load Connected at EN

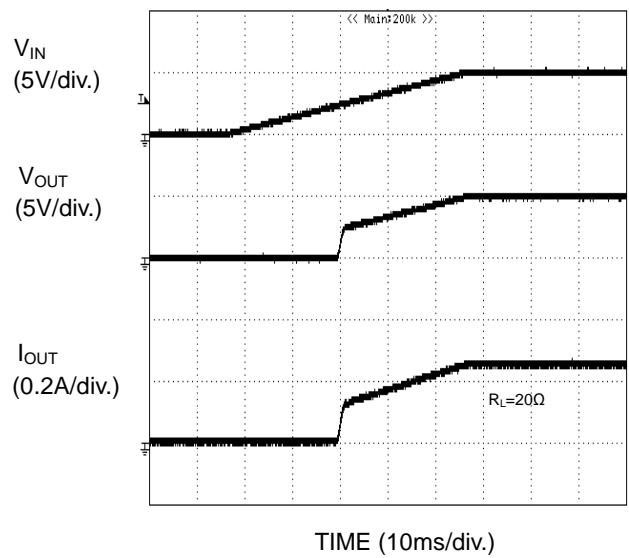

Figure 70. UVLO Response when Increasing V_{IN}

Typical Wave Forms – continued
 (BD2264G-M)

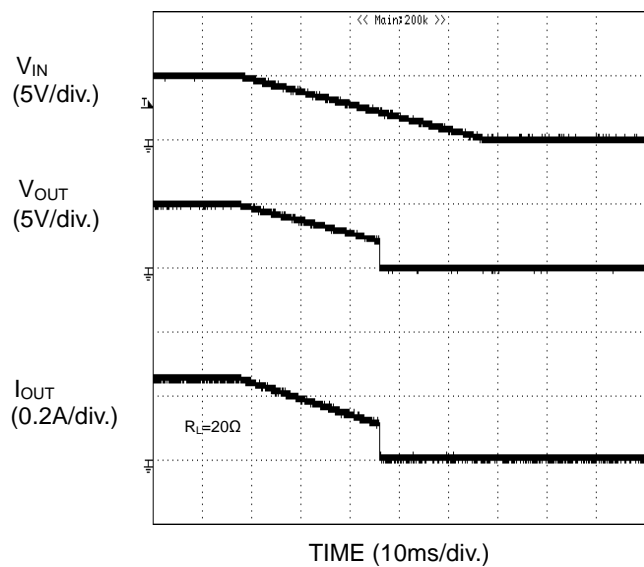
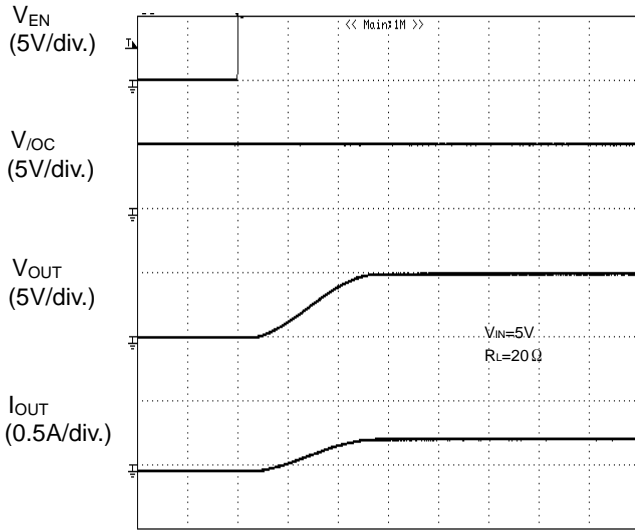
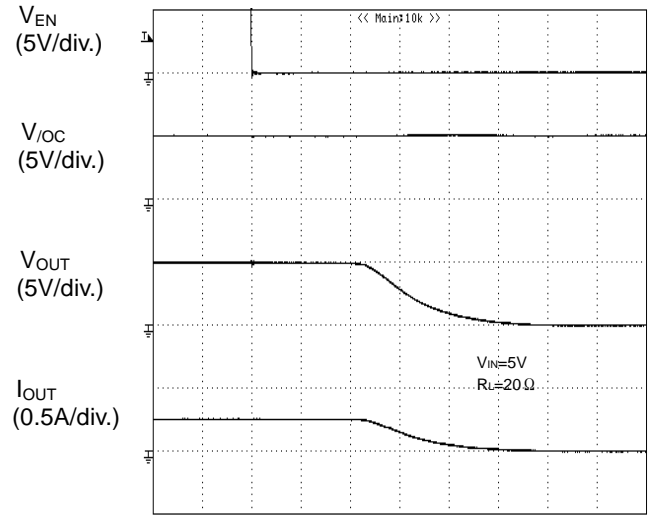

Figure 71. UVLO Response when
 Decreasing V_{IN}

Typical Wave Forms – continued
(BD2266G-M)



TIME(1ms/div.)
Figure 72. Output rise characteristic



TIME(1us/div.)
Figure 73. Output fall characteristic

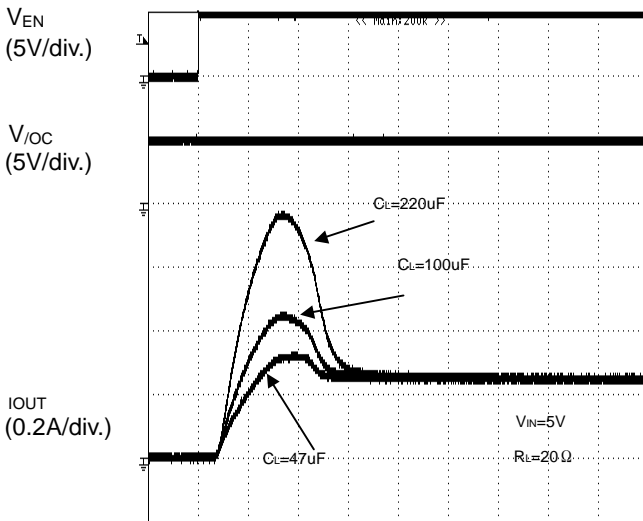

TIME (1ms/div.)
Figure 74. Inrush current response

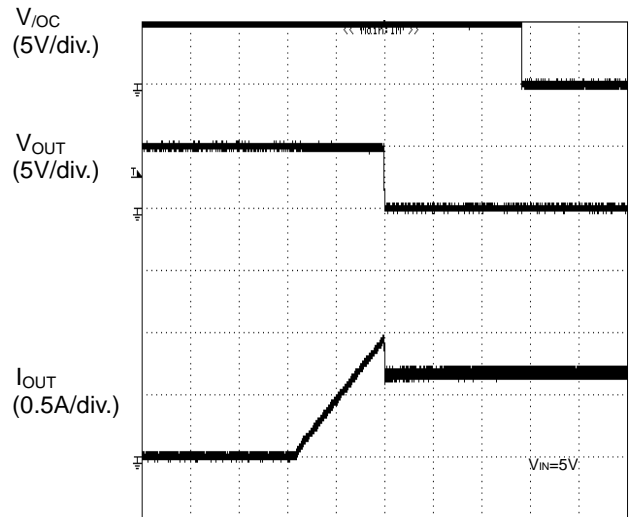

TIME (5ms/div.)
Figure 75. Over-current response ramped load

Typical Wave Forms – continued
(BD2266G-M)

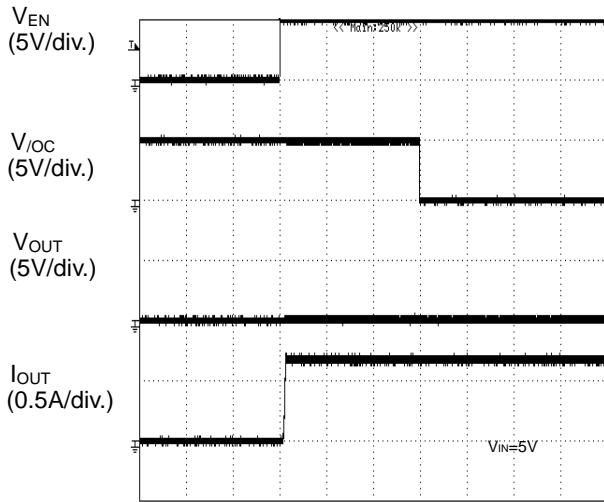

TIME (5ms/div.)
Figure 76. Over-current response
enable to shortcircuit

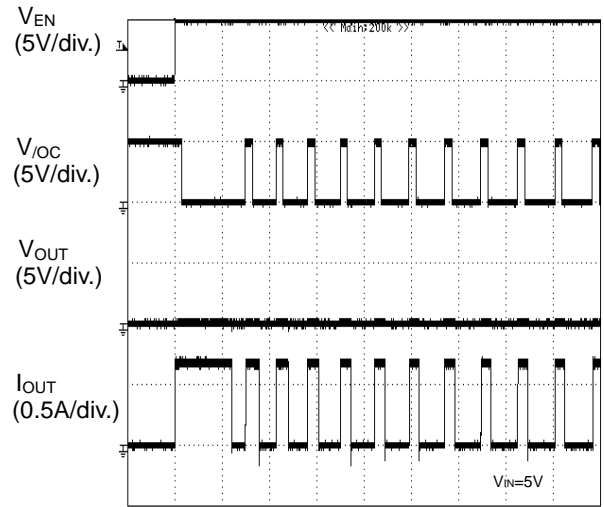

TIME (100ms/div.)
Figure 77. Over-current response
enable to shortcircuit

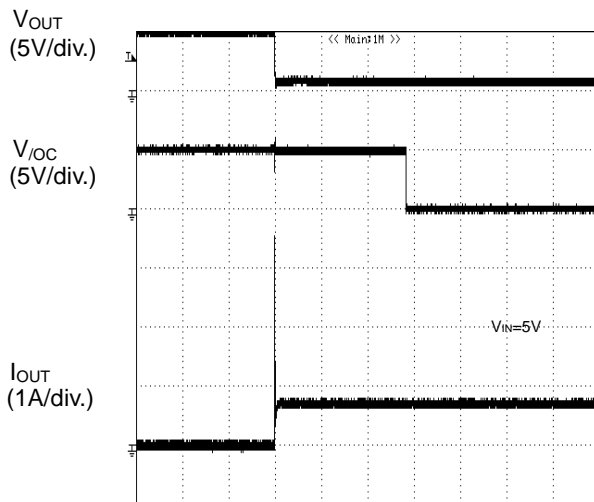

TIME (5ms/div.)
Figure 78. Over-current response
1Ω load to enabled device

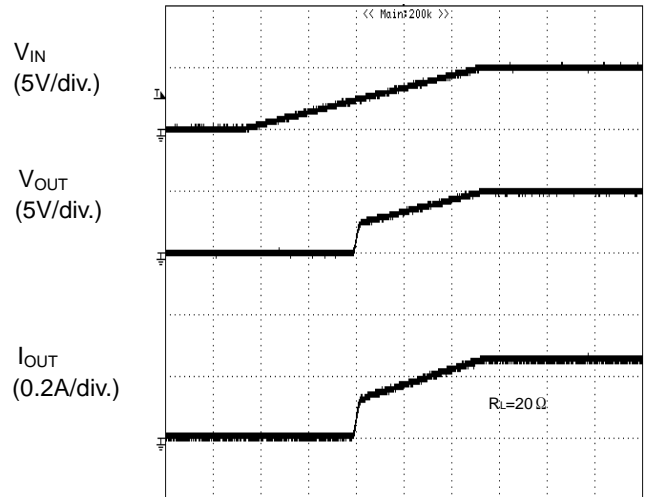

TIME (10ms/div.)
Figure 79. UVLO response
increasing V_{IN}

Typical Wave Forms – continued
 (BD2266G-M)

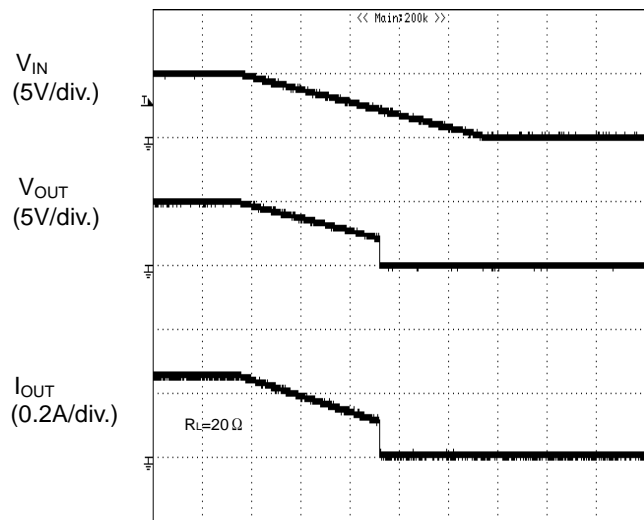

TIME (10ms/div.)
 Figure 80. UVLO response
 decreasing V_{IN}

Typical Application Circuit

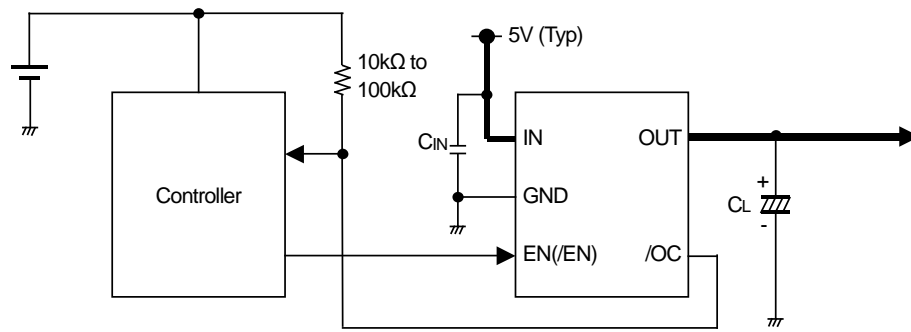

Application Information

When excessive current flows due to output short-circuit or so, ringing occurs by inductance of power source line and IC. This may cause bad effects on IC operations. In order to avoid this case, a bypass capacitor (C_{IN}) should be connected across the IN terminal and GND terminal of IC. A $1\mu\text{F}$ or higher value is recommended. Moreover, in order to decrease voltage fluctuations of power source line and IC, connect a low ESR capacitor in parallel with C_{IN} . A $10\mu\text{F}$ to $100\mu\text{F}$ or higher is effective.

Pull up /OC output by resistance $10\text{k}\Omega$ to $100\text{k}\Omega$.

Set up values for C_L which satisfies the application.

This application circuit does not guarantee its operation.

When using the circuit with changes to the external circuit constants, make sure to leave an adequate margin for external components including AC/DC characteristics as well as dispersion of the IC.

Functional Description

1. Switch Operation

IN terminal and OUT terminal are connected to the drain and the source of switch MOSFET respectively. The IN terminal is also used as power source input to internal control circuit.

When the switch is turned ON from EN(/EN) control input, the IN and OUT terminals are connected by a $120\text{m}\Omega$ (Typ) switch. In ON status, the switch is bidirectional. Therefore, when the potential of OUT terminal is higher than that of IN terminal, current flows from OUT to IN terminal. On the other hand, when the switch is turned off, it is possible to prevent current from flowing reversely from OUT to IN terminal since a parasitic diode between the drain and the source of switch MOSFET is not present.

2. Thermal Shutdown Circuit (TSD)

If over-current would continue, the temperature of the IC would increase drastically. If the junction temperature goes beyond 135°C (Typ) in the condition of over-current detection, thermal shutdown circuit operates and turns power switch off, causing the IC to output a fault flag (/OC). Then, when the junction temperature decreases lower than 115°C (Typ), the power switch is turned on and fault flag (/OC) is cancelled. This operation repeats, unless the increase of chip's temperature is removed or the output of power switch is turned OFF.

The thermal shutdown circuit operates when the switch is ON (EN(/EN) signal is active).

3. Over-Current Detection (OCD)

The over-current detection circuit limits current (I_{SC}) and outputs fault flag (/OC) when current flowing in each switch MOSFET exceeds a specified value. The over-current detection circuit works when the switch is on (EN(/EN) signal is active). There are three types of response against over-current:

- (1) When the switch is turned on while the output is in short circuit status, the switch goes into current limit status immediately.
- (2) When the output short-circuits or high capacity load is connected while the switch is on, very large current flows until the over-current limit circuit reacts. When the current detection and limit circuit operates, current limitation is carried out.
- (3) When the output current increases gradually, current limitation would not operate unless the output current exceeds the over-current detection value. When it exceeds the detection value, current limitation is carried out.

4. Under-Voltage Lockout (UVLO)

UVLO circuit prevents the switch from turning on until the V_{IN} exceeds 2.3V(Typ). If V_{IN} drops below 2.2V(Typ) while the switch is still ON, then UVLO shuts off the power switch. UVLO has a hysteresis of 100mV(Typ). Under-voltage lockout circuit operates when the switch is on (EN/ \overline{EN}) signal is active).

5. Fault Flag (/OC) Output

Fault flag output is N-MOS open drain output. During detection of over-current and/or thermal shutdown, the output level will turn low.

Over-current detection has delay filter. This delay filter prevents current detection flags from being sent during instantaneous events such as inrush current at switch on or during hot plug. If fault flag output is unused, /OC pin should be connected to open or ground line.

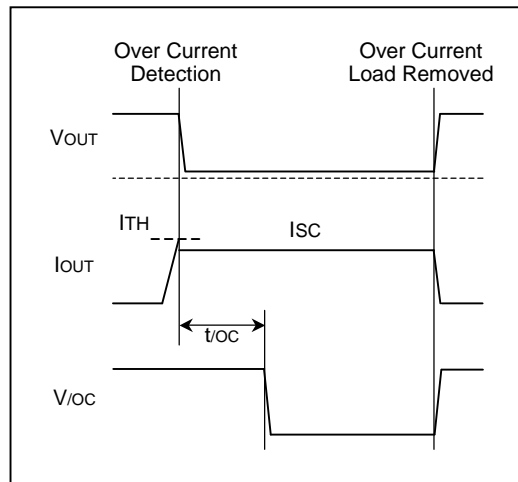

Figure 81. Over-Current Detection

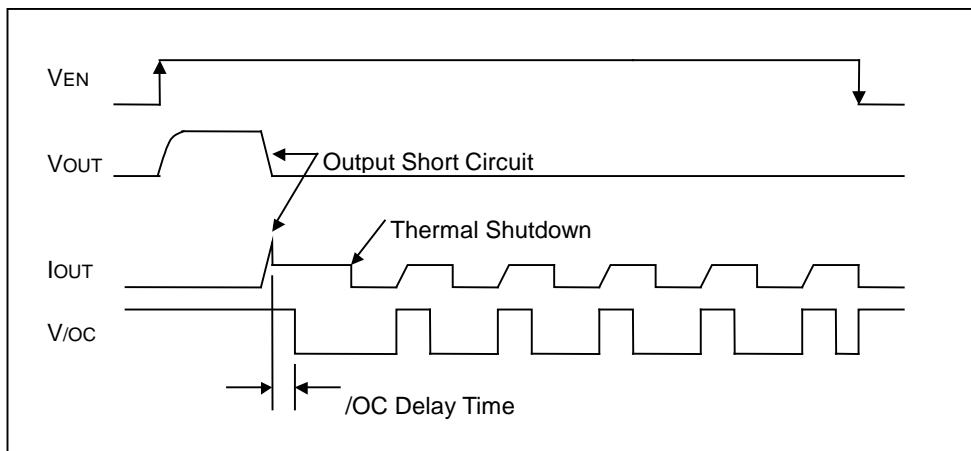

Figure 82. Over-Current Detection, Thermal Shutdown Timing (BD2262G-M, BD2264G-M, BD2266G-M)

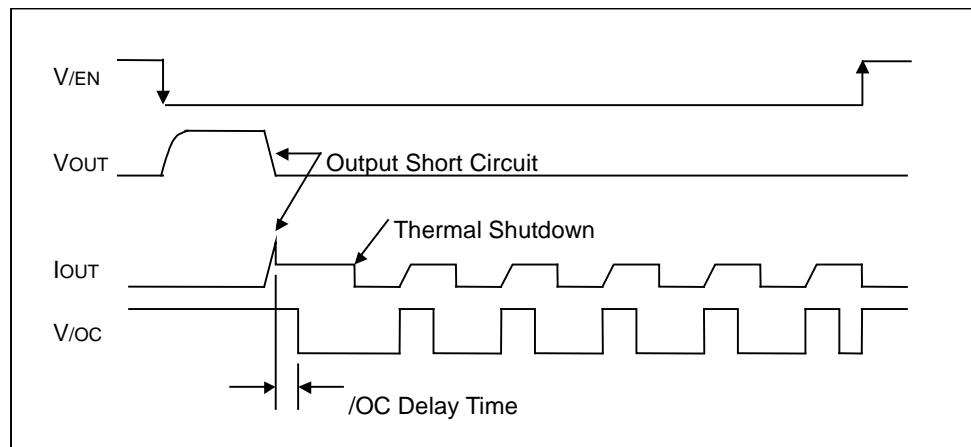
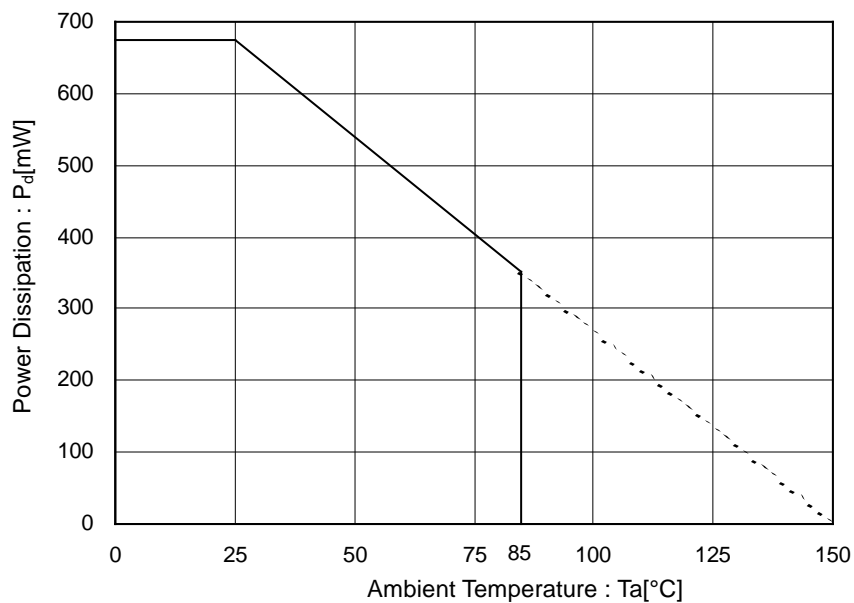

Figure 83. Over-Current Detection, Thermal Shutdown Timing (BD2265G-M, BD2267G-M)

Power Dissipation
(SSOP5 Package)



70mm x 70mm x 1.6mm Glass Epoxy Board

Figure 84. Power Dissipation Curve (Pd-Ta Curve)

I/O Equivalence Circuit

Symbol	Pin No.	Equivalence Circuit
EN (/EN)	3	
OUT	5	
/OC	4	

Operational Notes**1. Reverse Connection of Power Supply**

Connecting the power supply in reverse polarity can damage the IC. Take precautions against reverse polarity when connecting the power supply, such as mounting an external diode between the power supply and the IC's power supply pins.

2. Power Supply Lines

Design the PCB layout pattern to provide low impedance supply lines. Separate the ground and supply lines of the digital and analog blocks to prevent noise in the ground and supply lines of the digital block from affecting the analog block. Furthermore, connect a capacitor to ground at all power supply pins. Consider the effect of temperature and aging on the capacitance value when using electrolytic capacitors.

3. Ground Voltage

Ensure that no pins are at a voltage below that of the ground pin at any time, even during transient condition.

4. Ground Wiring Pattern

When using both small-signal and large-current ground traces, the two ground traces should be routed separately but connected to a single ground at the reference point of the application board to avoid fluctuations in the small-signal ground caused by large currents. Also ensure that the ground traces of external components do not cause variations on the ground voltage. The ground lines must be as short and thick as possible to reduce line impedance.

5. Thermal Consideration

Should by any chance the power dissipation rating be exceeded the rise in temperature of the chip may result in deterioration of the properties of the chip. The absolute maximum rating of the Pd stated in this specification is when the IC is mounted on a 70mm x 70mm x 1.6mm glass epoxy board. In case of exceeding this absolute maximum rating, increase the board size and copper area to prevent exceeding the Pd rating.

6. Recommended Operating Conditions

These conditions represent a range within which the expected characteristics of the IC can be approximately obtained. The electrical characteristics are guaranteed under the conditions of each parameter.

7. Inrush Current

When power is first supplied to the IC, it is possible that the internal logic may be unstable and inrush current may flow instantaneously due to the internal powering sequence and delays, especially if the IC has more than one power supply. Therefore, give special consideration to power coupling capacitance, power wiring, width of ground wiring, and routing of connections.

8. Operation Under Strong Electromagnetic Field

Operating the IC in the presence of a strong electromagnetic field may cause the IC to malfunction.

9. Testing on Application Boards

When testing the IC on an application board, connecting a capacitor directly to a low-impedance output pin may subject the IC to stress. Always discharge capacitors completely after each process or step. The IC's power supply should always be turned off completely before connecting or removing it from the test setup during the inspection process. To prevent damage from static discharge, ground the IC during assembly and use similar precautions during transport and storage.

10. Inter-pin Short and Mounting Errors

Ensure that the direction and position are correct when mounting the IC on the PCB. Incorrect mounting may result in damaging the IC. Avoid nearby pins being shorted to each other especially to ground, power supply and output pin. Inter-pin shorts could be due to many reasons such as metal particles, water droplets (in very humid environment) and unintentional solder bridge deposited in between pins during assembly to name a few.

11. Unused Input Pins

Input pins of an IC are often connected to the gate of a MOS transistor. The gate has extremely high impedance and extremely low capacitance. If left unconnected, the electric field from the outside can easily charge it. The small charge acquired in this way is enough to produce a significant effect on the conduction through the transistor and cause unexpected operation of the IC. So unless otherwise specified, unused input pins should be connected to the power supply or ground line.

Operational Notes - continued

12. Regarding the Input Pin of the IC

This monolithic IC contains P+ isolation and P substrate layers between adjacent elements in order to keep them isolated. P-N junctions are formed at the intersection of the P layers with the N layers of other elements, creating a parasitic diode or transistor. For example (refer to figure below):

When GND > Pin A and GND > Pin B, the P-N junction operates as a parasitic diode.
 When GND > Pin B, the P-N junction operates as a parasitic transistor.

Parasitic diodes inevitably occur in the structure of the IC. The operation of parasitic diodes can result in mutual interference among circuits, operational faults, or physical damage. Therefore, conditions that cause these diodes to operate, such as applying a voltage lower than the GND voltage to an input pin (and thus to the P substrate) should be avoided.

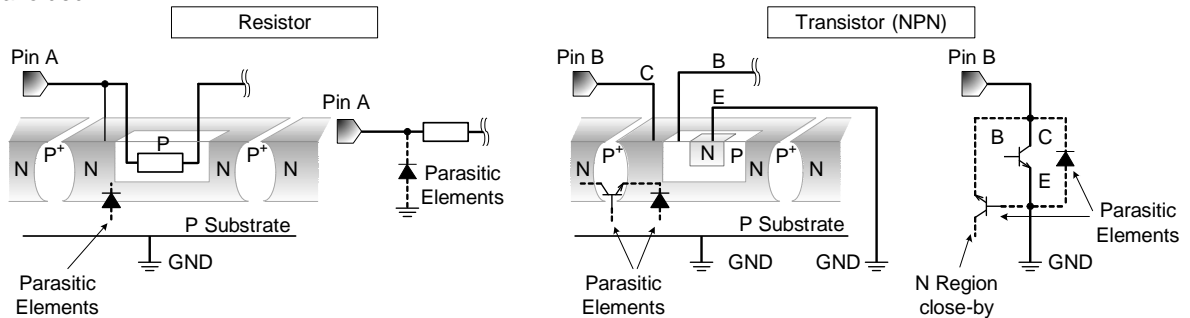

Figure 85. Example of monolithic IC structure

13. Ceramic Capacitor

When using a ceramic capacitor, determine the dielectric constant considering the change of capacitance with temperature and the decrease in nominal capacitance due to DC bias and others.

14. Thermal Shutdown Circuit(TSD)

This IC has a built-in thermal shutdown circuit that prevents heat damage to the IC. Normal operation should always be within the IC's power dissipation rating. If however the rating is exceeded for a continued period, the junction temperature (Tj) will rise which will activate the TSD circuit that will turn OFF all output pins. When the Tj falls below the TSD threshold, the circuits are automatically restored to normal operation.

Note that the TSD circuit operates in a situation that exceeds the absolute maximum ratings and therefore, under no circumstances, should the TSD circuit be used in a set design or for any purpose other than protecting the IC from heat damage.

15. Thermal design

Perform thermal design in which there are adequate margins by taking into account the power dissipation (Pd) in actual states of use.

Ordering Information

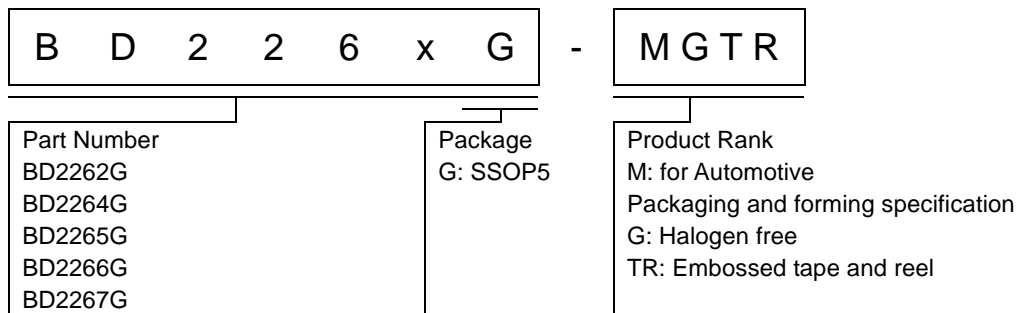

Marking Diagram

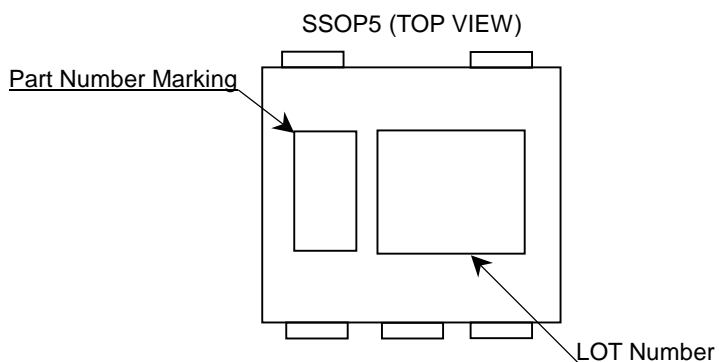

Part Number	Part Number Marking
BD2262G-M	Z0
BD2264G-M	Z1
BD2265G-M	Z2
BD2266G-M	Z3
BD2267G-M	Z4

Physical Dimension, Tape and Reel Information

Package Name	SSOP5
--------------	-------

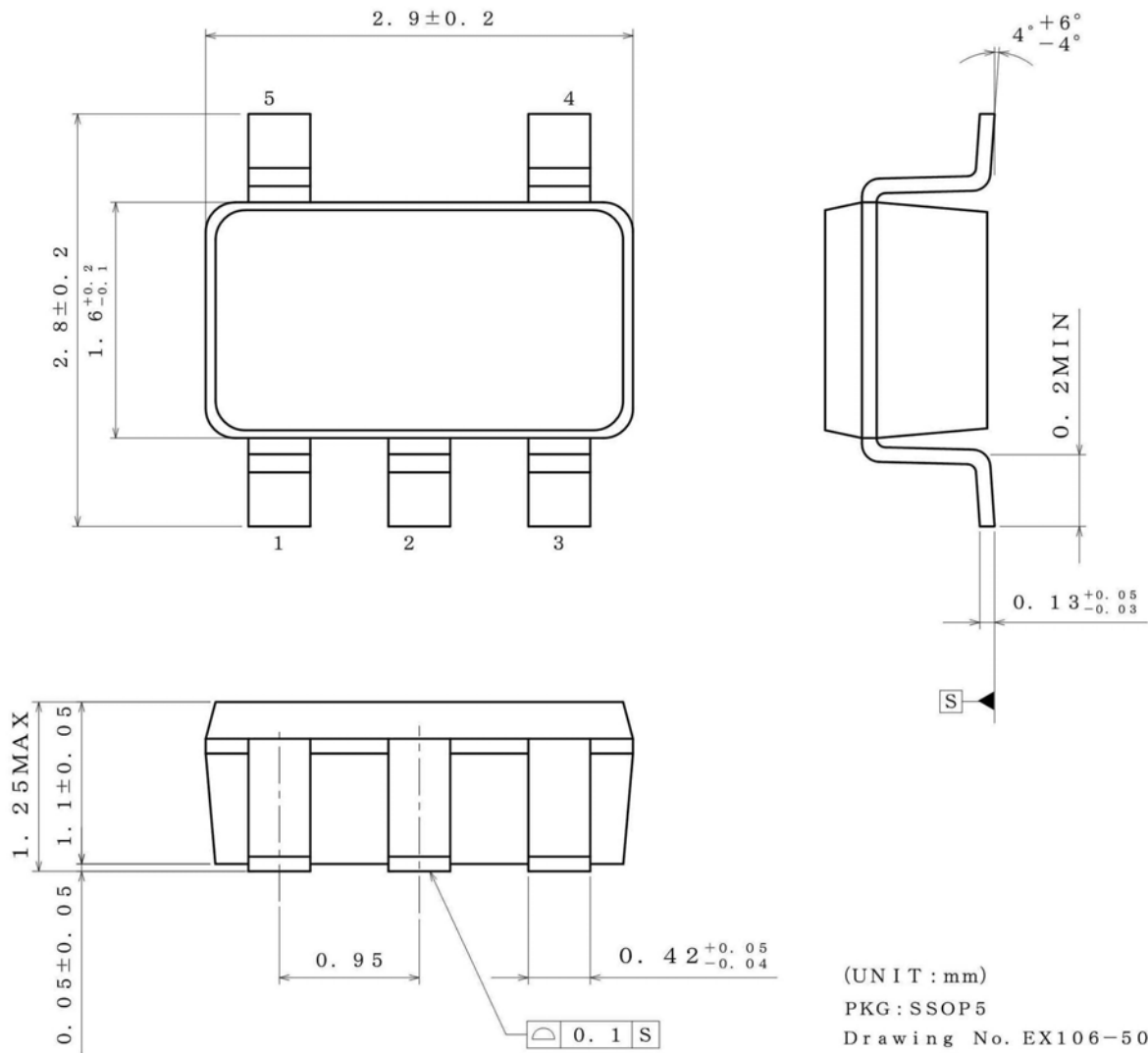

< Tape and Reel Information >

Tape	Embossed carrier tape
Quantity	3000pcs
Direction of feed	TR (The direction is the 1 pin of product is at the upper right when you hold reel on the left hand and you pull out the tape on the right hand)

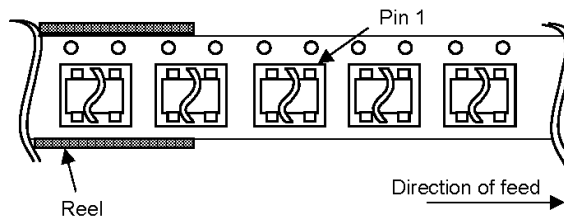

Revision History

Date	Revision	Changes
03.Feb.2014	001	New Release

Notice

Precaution on using ROHM Products

1. If you intend to use our Products in devices requiring extremely high reliability (such as medical equipment ^(Note 1), aircraft/spacecraft, nuclear power controllers, etc.) and whose malfunction or failure may cause loss of human life, bodily injury or serious damage to property ("Specific Applications"), please consult with the ROHM sales representative in advance. Unless otherwise agreed in writing by ROHM in advance, ROHM shall not be in any way responsible or liable for any damages, expenses or losses incurred by you or third parties arising from the use of any ROHM's Products for Specific Applications.

(Note1) Medical Equipment Classification of the Specific Applications

JAPAN	USA	EU	CHINA
CLASS III	CLASS III	CLASS II b	CLASS III
CLASS IV		CLASS III	

2. ROHM designs and manufactures its Products subject to strict quality control system. However, semiconductor products can fail or malfunction at a certain rate. Please be sure to implement, at your own responsibilities, adequate safety measures including but not limited to fail-safe design against the physical injury, damage to any property, which a failure or malfunction of our Products may cause. The following are examples of safety measures:
 - [a] Installation of protection circuits or other protective devices to improve system safety
 - [b] Installation of redundant circuits to reduce the impact of single or multiple circuit failure
3. Our Products are not designed under any special or extraordinary environments or conditions, as exemplified below. Accordingly, ROHM shall not be in any way responsible or liable for any damages, expenses or losses arising from the use of any ROHM's Products under any special or extraordinary environments or conditions. If you intend to use our Products under any special or extraordinary environments or conditions (as exemplified below), your independent verification and confirmation of product performance, reliability, etc, prior to use, must be necessary:
 - [a] Use of our Products in any types of liquid, including water, oils, chemicals, and organic solvents
 - [b] Use of our Products outdoors or in places where the Products are exposed to direct sunlight or dust
 - [c] Use of our Products in places where the Products are exposed to sea wind or corrosive gases, including Cl₂, H₂S, NH₃, SO₂, and NO₂
 - [d] Use of our Products in places where the Products are exposed to static electricity or electromagnetic waves
 - [e] Use of our Products in proximity to heat-producing components, plastic cords, or other flammable items
 - [f] Sealing or coating our Products with resin or other coating materials
 - [g] Use of our Products without cleaning residue of flux (even if you use no-clean type fluxes, cleaning residue of flux is recommended); or Washing our Products by using water or water-soluble cleaning agents for cleaning residue after soldering
 - [h] Use of the Products in places subject to dew condensation
4. The Products are not subject to radiation-proof design.
5. Please verify and confirm characteristics of the final or mounted products in using the Products.
6. In particular, if a transient load (a large amount of load applied in a short period of time, such as pulse. is applied, confirmation of performance characteristics after on-board mounting is strongly recommended. Avoid applying power exceeding normal rated power; exceeding the power rating under steady-state loading condition may negatively affect product performance and reliability.
7. De-rate Power Dissipation (Pd) depending on Ambient temperature (Ta). When used in sealed area, confirm the actual ambient temperature.
8. Confirm that operation temperature is within the specified range described in the product specification.
9. ROHM shall not be in any way responsible or liable for failure induced under deviant condition from what is defined in this document.

Precaution for Mounting / Circuit board design

1. When a highly active halogenous (chlorine, bromine, etc.) flux is used, the residue of flux may negatively affect product performance and reliability.
2. In principle, the reflow soldering method must be used; if flow soldering method is preferred, please consult with the ROHM representative in advance.

For details, please refer to ROHM Mounting specification

Precautions Regarding Application Examples and External Circuits

1. If change is made to the constant of an external circuit, please allow a sufficient margin considering variations of the characteristics of the Products and external components, including transient characteristics, as well as static characteristics.
2. You agree that application notes, reference designs, and associated data and information contained in this document are presented only as guidance for Products use. Therefore, in case you use such information, you are solely responsible for it and you must exercise your own independent verification and judgment in the use of such information contained in this document. ROHM shall not be in any way responsible or liable for any damages, expenses or losses incurred by you or third parties arising from the use of such information.

Precaution for Electrostatic

This Product is electrostatic sensitive product, which may be damaged due to electrostatic discharge. Please take proper caution in your manufacturing process and storage so that voltage exceeding the Products maximum rating will not be applied to Products. Please take special care under dry condition (e.g. Grounding of human body / equipment / solder iron, isolation from charged objects, setting of ionizer, friction prevention and temperature / humidity control).

Precaution for Storage / Transportation

1. Product performance and soldered connections may deteriorate if the Products are stored in the places where:
 - [a] the Products are exposed to sea winds or corrosive gases, including Cl₂, H₂S, NH₃, SO₂, and NO₂
 - [b] the temperature or humidity exceeds those recommended by ROHM
 - [c] the Products are exposed to direct sunshine or condensation
 - [d] the Products are exposed to high Electrostatic
2. Even under ROHM recommended storage condition, solderability of products out of recommended storage time period may be degraded. It is strongly recommended to confirm solderability before using Products of which storage time is exceeding the recommended storage time period.
3. Store / transport cartons in the correct direction, which is indicated on a carton with a symbol. Otherwise bent leads may occur due to excessive stress applied when dropping of a carton.
4. Use Products within the specified time after opening a humidity barrier bag. Baking is required before using Products of which storage time is exceeding the recommended storage time period.

Precaution for Product Label

QR code printed on ROHM Products label is for ROHM's internal use only.

Precaution for Disposition

When disposing Products please dispose them properly using an authorized industry waste company.

Precaution for Foreign Exchange and Foreign Trade act

Since our Products might fall under controlled goods prescribed by the applicable foreign exchange and foreign trade act, please consult with ROHM representative in case of export.

Precaution Regarding Intellectual Property Rights

1. All information and data including but not limited to application example contained in this document is for reference only. ROHM does not warrant that foregoing information or data will not infringe any intellectual property rights or any other rights of any third party regarding such information or data. ROHM shall not be in any way responsible or liable for infringement of any intellectual property rights or other damages arising from use of such information or data.:
2. No license, expressly or implied, is granted hereby under any intellectual property rights or other rights of ROHM or any third parties with respect to the information contained in this document.

Other Precaution



1. This document may not be reprinted or reproduced, in whole or in part, without prior written consent of ROHM.
2. The Products may not be disassembled, converted, modified, reproduced or otherwise changed without prior written consent of ROHM.
3. In no event shall you use in any way whatsoever the Products and the related technical information contained in the Products or this document for any military purposes, including but not limited to, the development of mass-destruction weapons.
4. The proper names of companies or products described in this document are trademarks or registered trademarks of ROHM, its affiliated companies or third parties.

General Precaution



1. Before you use our Products, you are requested to carefully read this document and fully understand its contents. ROHM shall not be in any way responsible or liable for failure, malfunction or accident arising from the use of any ROHM's Products against warning, caution or note contained in this document.
2. All information contained in this document is current as of the issuing date and subject to change without any prior notice. Before purchasing or using ROHM's Products, please confirm the latest information with a ROHM sales representative.
3. The information contained in this document is provided on an "as is" basis and ROHM does not warrant that all information contained in this document is accurate and/or error-free. ROHM shall not be in any way responsible or liable for any damages, expenses or losses incurred by you or third parties resulting from inaccuracy or errors of or concerning such information.

Looking for pricing, stock, or lifecycle information?

Click below to explore more details on WIN SOURCE:

-  [View BD2264G-MGTR on WIN SOURCE](#)
-  [Rohm Semiconductor](#) Information

Optimize Your Supply Chain with WIN SOURCE Solutions

-  Global Sourcing Solution
-  Obsolete Management
-  Cost Control Management
-  Shortage Management
-  Alternative Solution
-  Excess Inventory Management