



**THE DATASHEET OF
BD2425N5075AHF**



Xinger®

Ultra Low Profile 0404 Balun 50Ω to 75Ω Balanced

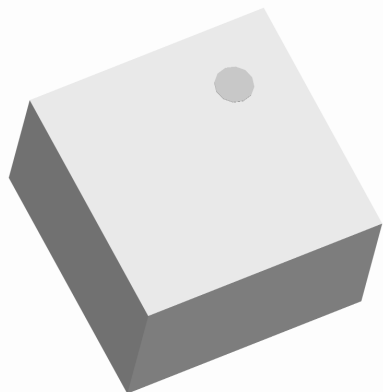

Description

The BD2425N5075AHF is a low cost, low profile sub-miniature unbalanced to balanced transformer designed for differential inputs and output locations on modern chipsets in an easy to use surface mount package. The BD2425N5075AHF is halogen-free, ideal for high volume manufacturing and delivers higher performance than traditional ceramic baluns. The BD2425N5075AHF has an unbalanced port impedance of 50Ω and a 75Ω balanced port impedance. This transformation enables single ended signals to be applied to differential ports on modern integrated chipsets. The output ports have equal amplitude (-3dB) with 180 degree phase differential. The BD2425N5075AHF is available on tape and reel for pick and place high volume manufacturing.

Detailed Electrical Specifications: Specifications subject to change without notice.

Features:

- 2400 – 2500 MHz
- 0.56mm Height Profile
- 50 Ohm to 2 x 37.5 Ohm
- Low Insertion Loss
- 802.11 b+g
- MIMO b+g
- Bluetooth
- Zigbee
- Surface Mountable
- Tape & Reel
- Non-conductive surface
- RoHS Compliant
- Halogen-Free

Parameter	ROOM (25°C)			Unit
	Min.	Typ.	Max	
Frequency	2400		2500	MHz
Unbalanced Port Impedance		50		Ω
Balanced Port Impedance		75		Ω
Return Loss	14	18		dB
Insertion Loss*		0.7	0.9	dB
Amplitude Balance		0.3	0.9	dB
Phase Balance		1	3	Degrees
CMRR		35		dB
Power Handling			1	Watts
Operating Temperature	-55		+85	°C

* Insertion Loss stated at room temperature (Insertion Loss is approximately 0.1 dB higher at +85 °C)

Outline Drawing

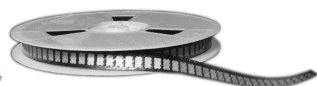
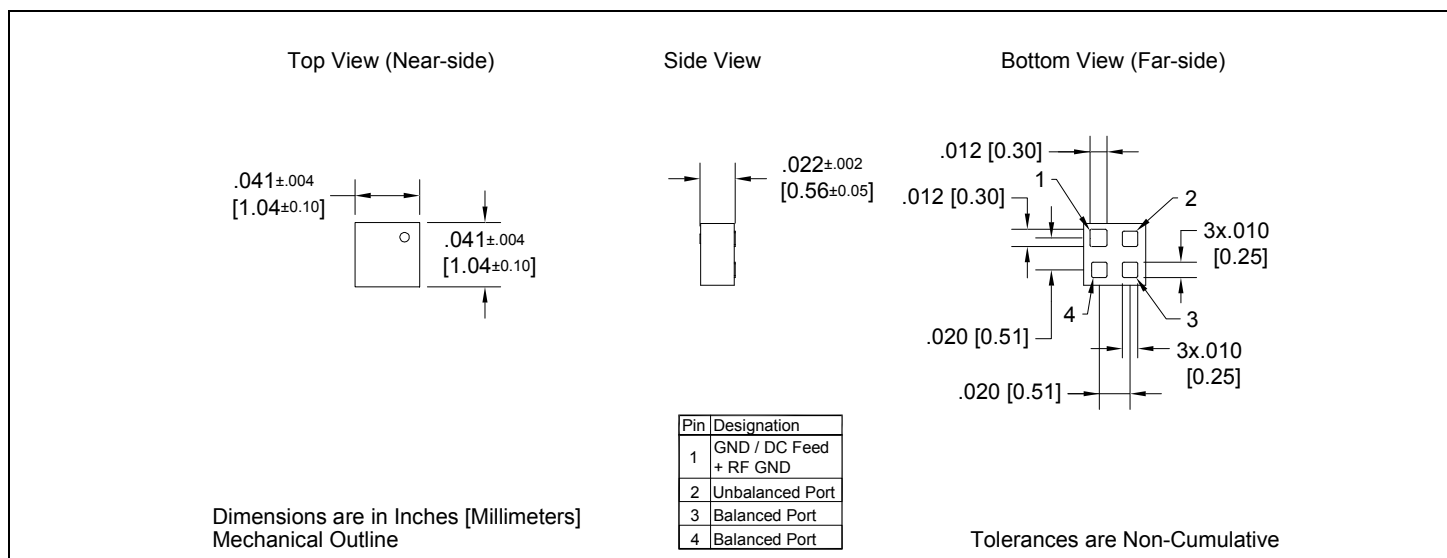

Typical Performance: 2300 MHz. to 2600 MHz.

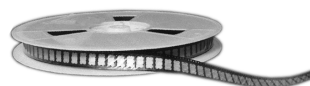
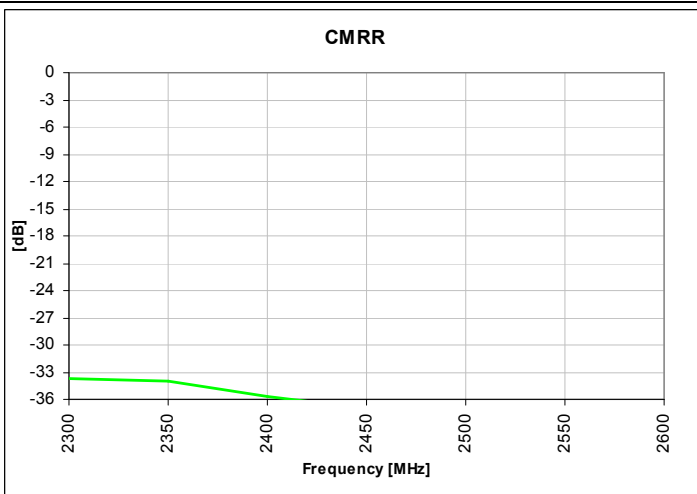
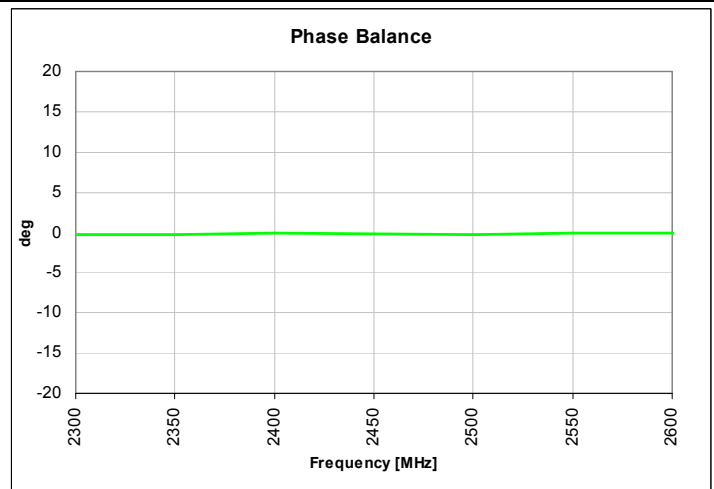
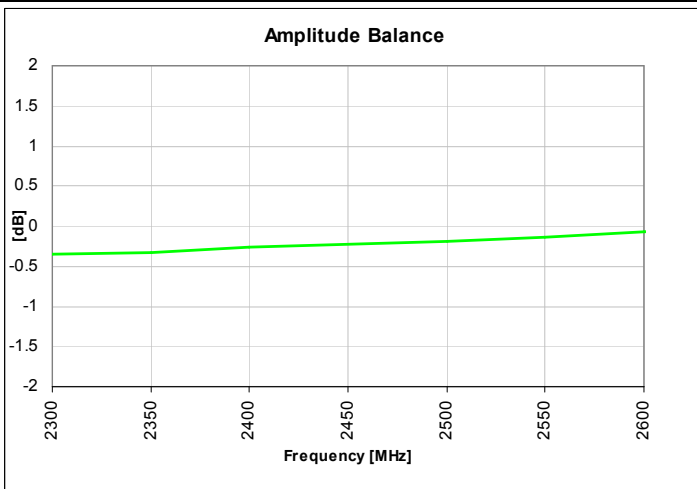
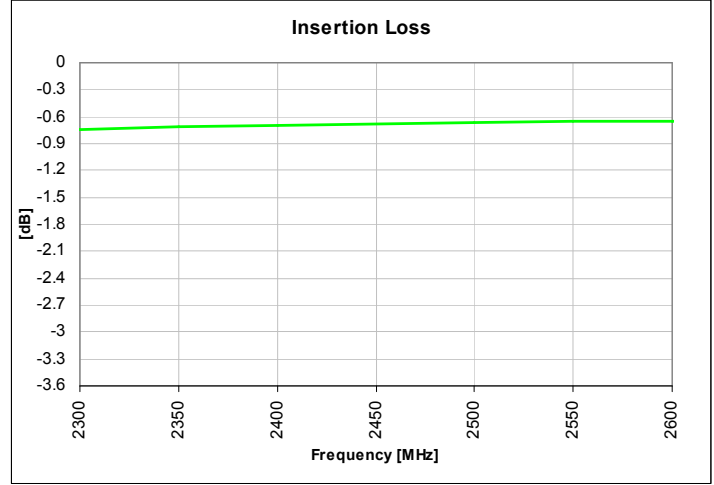
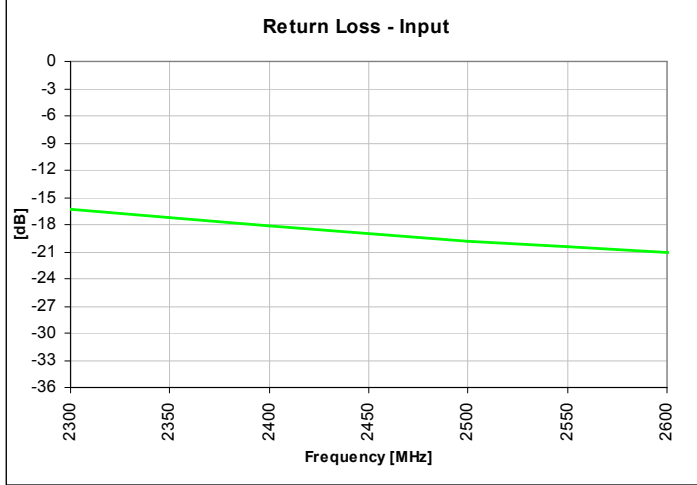

Wide Band Performance: 500 MHz. to 8500 MHz.

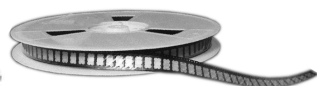
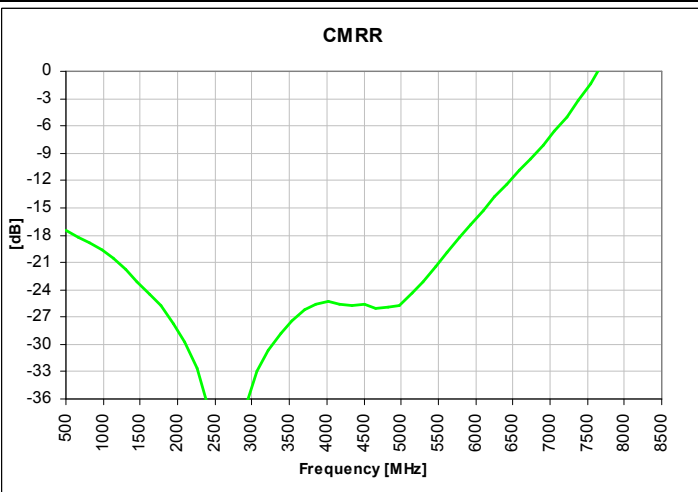
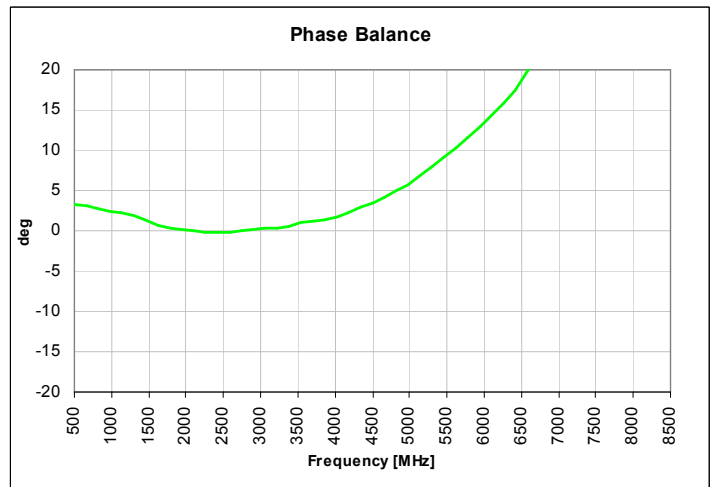
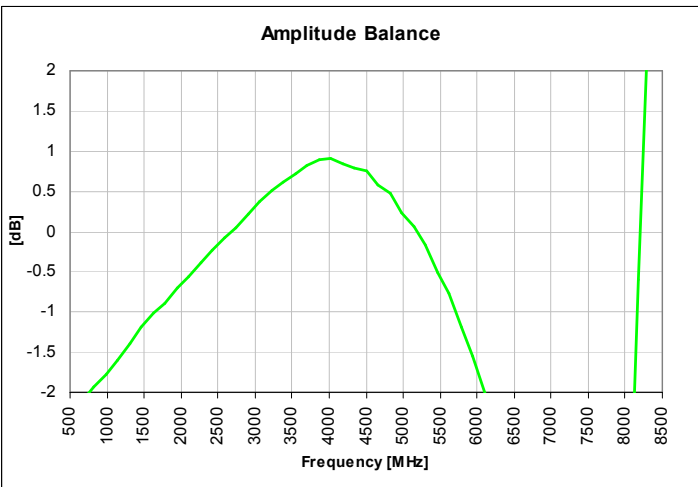
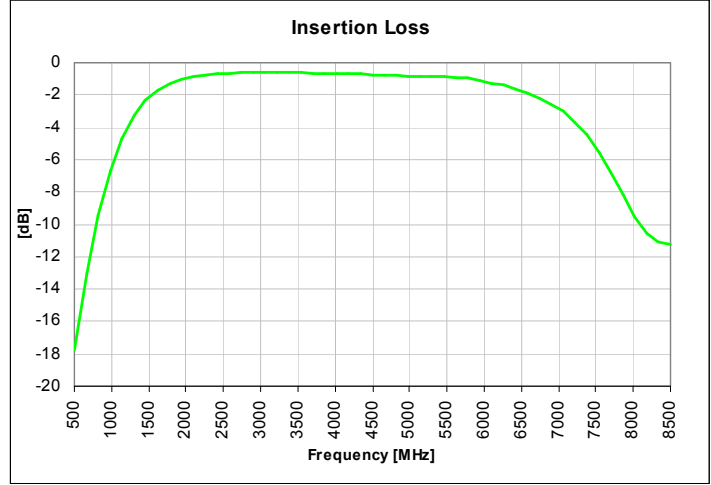
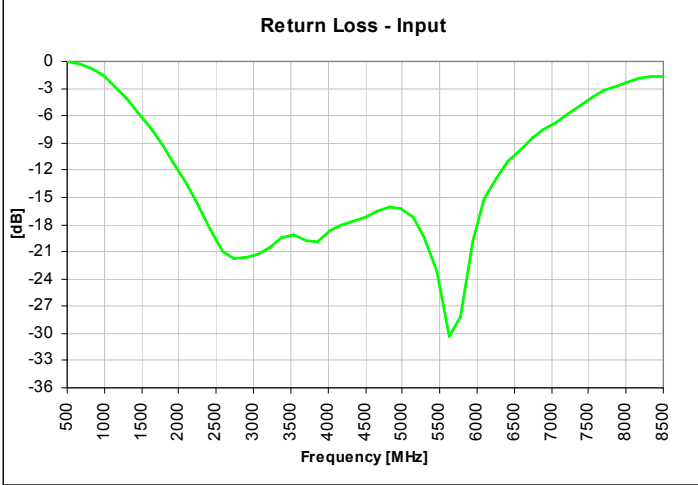

Mounting Configuration:

In order for Xinger surface mount components to work optimally, the proper impedance transmission lines must be used to connect to the RF ports. If this condition is not satisfied, insertion loss, Isolation and VSWR may not meet published specifications.

All of the Xinger components are constructed from ceramic filled PTFE composites which possess excellent electrical and mechanical stability having X and Y thermal coefficient of expansion (CTE) of 17 ppm/°C.

An example of the PCB footprint used in the testing of these parts is shown below. An example of a DC-biased footprint is also shown below. In specific designs, the transmission line widths need to be adjusted to the unique dielectric coefficients and thicknesses as well as varying pick and place equipment tolerances.

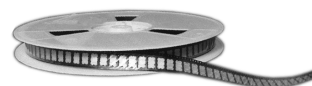
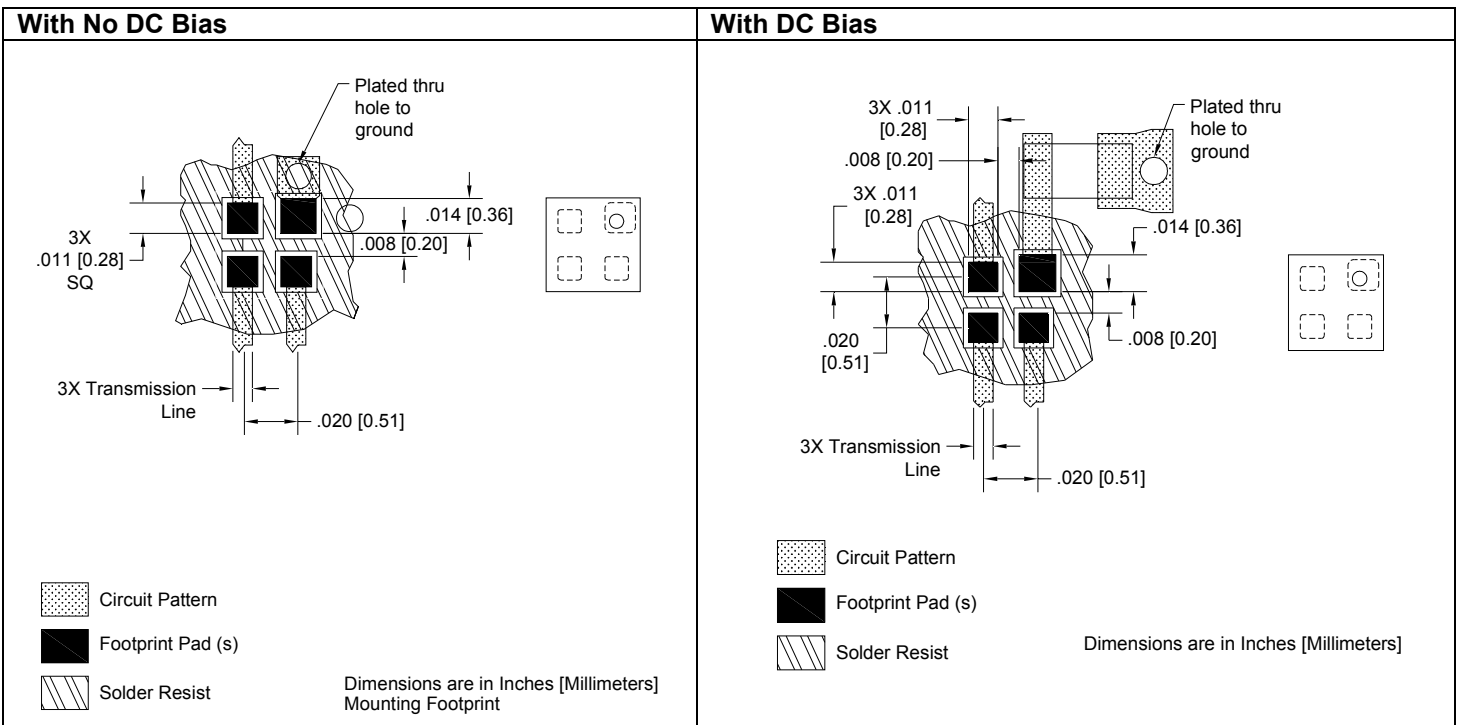

Packaging and Ordering Information

Parts are available in reel and are packaged per EIA 481-2. Parts are oriented in tape and reel as shown below. Minimum order quantities are 4000 per reel. See Model Numbers below for further ordering information.

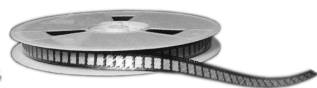
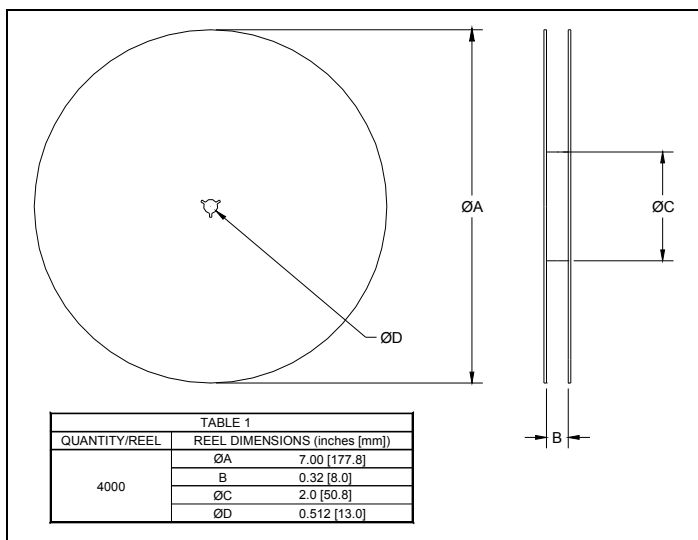
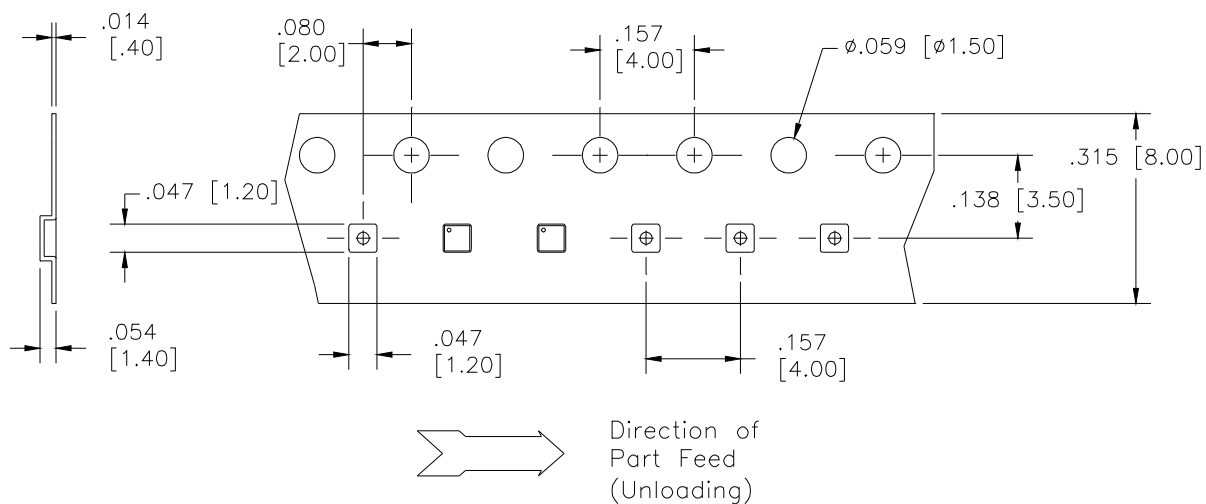

Looking for pricing, stock, or lifecycle information?

Click below to explore more details on WIN SOURCE:

 [View BD2425N5075AHF on WIN SOURCE](#)

 [Anaren Information](#)

Optimize Your Supply Chain with WIN SOURCE Solutions

-  Global Sourcing Solution
-  Obsolete Management
-  Cost Control Management
-  Shortage Management
-  Alternative Solution
-  Excess Inventory Management