



**THE DATASHEET OF
BA3474YFV-CE2**



Operational Amplifiers Series

Automotive High Speed Operational Amplifiers

BA3472Yxxx-C, BA3474YFV-C, BA3472WFV-C, BA3474WFV-C

● **General Description**

BA3472Y, BA3474Y, BA3472W, and BA3474W integrate two or four independent Op-amps on a single chip. These Op-Amps can operate from +3V to +36V (single power supply) with a high slew rate (10V/μs) and high-gain bandwidth (4MHz) characteristics.

● **Features**

- Single or dual power supply operation
- Wide operating supply voltage
- Standard Op-Amp Pin-assignments
- High open-loop voltage gain
- Internal ESD protection circuit
- Common-mode Input Voltage Range includes ground level, allowing direct ground sensing
- Wide output voltage range
- AEC-Q100 Qualified

● **Key Specifications**

- Wide Operating Supply Voltage:
 - Single supply +3.0V to +36.0V
 - Dual supply ±1.5V to ±18.0V
- Wide Temperature Range: -40°C to +125°C
- Input Offset Voltage:

BA3472Y, BA3474Y	10mV (Max.)
BA3472W, BA3474W	7.5mV (Max.)
- Low Input Offset Current: 6nA (Typ.)
- Low Input Bias Current: 100nA (Typ.)
- Wide Output Voltage Range:
 - VEE+0.3V to VCC-1.0V(Typ.)
 - (VCC-VEE=30V)
- High Slew Rate: 10V/μs(Typ.)
- Gain Band Width: 4MHz(Typ.)

● **Packages**

Package	W(Typ.) x D(Typ.) x H(Max.)
SOP8	5.00mm x 6.20mm x 1.71mm
SSOP-B8	3.00mm x 6.40mm x 1.35mm
MSOP8	2.90mm x 4.00mm x 0.90mm
SSOP-B14	5.00mm x 6.40mm x 1.35mm

● **Application**

- Engine Control Unit
- Electric Power Steering (EPS)
- Anti-Lock Braking System (ABS)
- All automotive application

● **Simplified schematic**

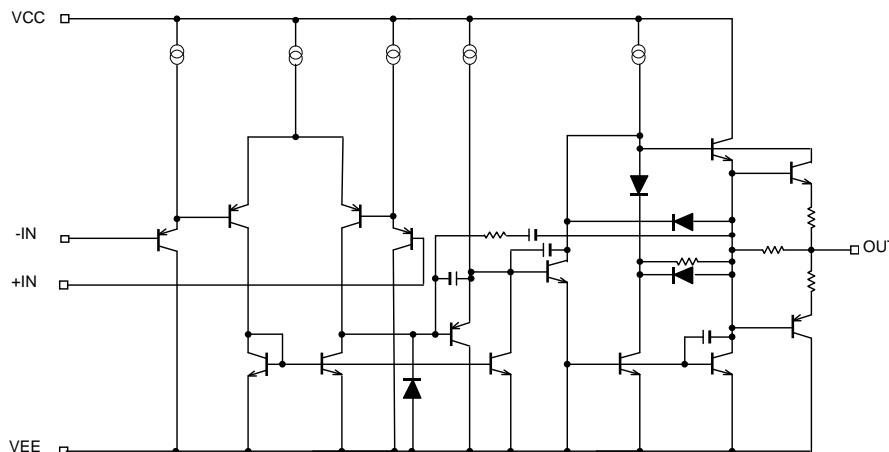
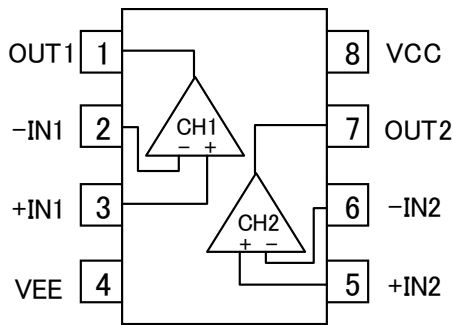

Figure 1. Simplified schematic (one channel only)

○Product structure : Silicon monolithic integrated circuit ○This product is not designed protection against radioactive rays.

●Pin Configuration(TOP VIEW)

SOP8, SSOP-B8, MSOP8



Pin No.	Symbol
1	OUT1
2	-IN1
3	+IN1
4	VEE
5	+IN2
6	-IN2
7	OUT2
8	VCC

SSOP-B14

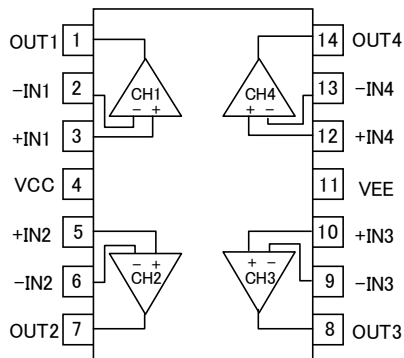

Pin No.	Symbol
1	OUT1
2	-IN1
3	+IN1
4	VCC
5	+IN2
6	-IN2
7	OUT2
8	OUT3
9	-IN3
10	+IN3
11	VEE
12	+IN4
13	-IN4
14	OUT4

Package			
SOP8	SSOP-B8	MSOP8	SSOP-B14
BA3472YF-C	BA3472YFV-C BA3472WFV-C	BA3472YFVM-C	BA3474YFV-C BA3474WFV-C

● Ordering Information

B	A	3	4	7	x	x	x	x	x	-	C	xx
---	---	---	---	---	---	---	---	---	---	---	---	----

Part Number
BA3472Y
BA3472W
BA3474Y
BA3474W

Package
F : SOP8
FV : SSOP-B8
SSOP-B14
FVM : MSOP8

C: Automotive (Engine control unit, EPS, ABS, and so on)
Packaging and forming specification
E2: Embossed tape and reel (SOP8/SSOP-B8/SSOP-B14)
TR: Embossed tape and reel (MSOP8)

● Line-up

Topr	Package		Orderable Part Number
-40°C to +125°C	SOP8	Reel of 2500	BA3472YF-CE2
	SSOP-B8	Reel of 2500	BA3472YFV-CE2
	MSOP8	Reel of 3000	BA3472YFVM-CTR
	SSOP-B8	Reel of 2500	BA3472WFV-CE2
	SSOP-B14	Reel of 2500	BA3474YFV-CE2
	SSOP-B14	Reel of 2500	BA3474WFV-CE2

● Absolute Maximum Ratings (Ta=25°C)

OBA3472Y, BA3472W, BA3474Y, BA3474W

Parameter	Symbol	Ratings	Unit	
Supply Voltage	VCC-VEE	+36	V	
Power dissipation	Pd	SOP8	1075 ^{*1*5}	mW
		SSOP-B8	835 ^{*1*3}	
		MSOP8	750 ^{*3*5}	
		SSOP-B14	1350 ^{*2*3}	
Differential Input Voltage ^{*6}	Vid	+36	V	
Input Common-mode Voltage Range	Vicm	(VEE-0.3) to VEE+36	V	
Operating Supply Voltage	Vopr	+3.0Vto+36.0V (±1.5Vto±18.0V)	V	
Operating Temperature	Topr	-40 to +125	°C	
Storage Temperature	Tstg	-55 to +150	°C	
Maximum Junction Temperature	Tjmax	+150	°C	

Note Absolute maximum rating item indicates the condition which must not be exceeded.

Application of voltage in excess of absolute maximum rating or use out absolute maximum rated temperature environment may cause deterioration of characteristics.

*1 To use at temperature above Ta=25°C reduce 8.6mW/°C.

*2 To use at temperature above Ta=25°C reduce 6.7mW/°C.

*3 To use at temperature above Ta=25°C reduce 6.0mW/°C.

*4 To use at temperature above Ta=25°C reduce 10.8mW/°C.

*5 Mounted on a FR4 glass epoxy 4 layers PCB 70mmx70mmx1.6mm (occupied copper area: 70mmx70mm).

*6 The voltage difference between inverting input and non-inverting input is the differential input voltage. Then input terminal voltage is set to more than VEE.

●Electrical Characteristics

OBA3472Y (Unless otherwise specified VCC=+15V, VEE=-15V)

Parameter	Symbol	Temperature range	Limits			Unit	Condition	
			Min.	Typ.	Max.			
Input Offset Voltage ^{*7}	Vio	full range	-	-	10	mV	Vicm=0V, OUT=0V	
			-	-	10		VCC=5V VEE=0V	Vicm=0V OUT=VCC/2
Input Offset Current ^{*7}	Iio	25°C	-	6	75	nA	Vicm=0V, OUT=0V	
		full range	-	-	100			
Input Bias Current ^{*8}	Ib	25°C	-	100	150	nA	Vicm=0V, OUT=0V	
		full range	-	-	200			
Supply Current	ICC	25°C	-	4	5	mA	RL=∞	
		full range	-	-	5.5			
Maximum Output Voltage(High)	VOH	25°C	3.7	4	-	V	VCC=5V VEE=0V	RL=2kΩ
		full range	3.5	-	-			
		25°C	13.7	14	-		RL=10kΩ	
		full range	13.5	-	-		RL=2kΩ	
Maximum Output Voltage(Low)	VOL	25°C	-	0.1	0.3	V	VCC=5V VEE=0V	RL=2kΩ
		full range	-	-	0.6			
		25°C	-	-14.7	-14.3		RL=10kΩ	
		full range	-	-	-14.0		RL=2kΩ	
Large Signal Voltage Gain	Av	25°C	80	100	-	dB	RL ≥ 2kΩ, OUT=±10V	
		full range	70	-	-			
Input Common-mode Voltage Range	Vicm	25°C	0	-	VCC-2.0	V	VCC=5V VEE=0V	OUT=VCC/2
		full range	0	-	VCC-2.6			
Common-mode Rejection Ratio	CMRR	25°C	60	97	-	dB	OUT=0V	
Power Supply Rejection Ratio	PSRR	25°C	60	97	-	dB	Vicm=0V, OUT=0V	
Output Source Current ^{*9}	Isource	25°C	10	30	-	mA	VCC=5V VEE=0V	IN+=1V IN-=0V OUT=0V Only 1ch is short circuit
		full range	10	-	-			
Output Sink Current ^{*9}	Isink	25°C	20	30	-	mA	VCC=5V VEE=0V	IN+=0V IN-=1V OUT=5V, Only 1ch is short circuit
		full range	20	-	-			
Gain Band Width	GBW	25°C	-	4	-	MHz	-	
Slew Rate	SR	25°C	-	10	-	V/μs	Av=1, IN=-10V to +10V, RL=2kΩ	
		full range	5	-	-			
Channel Separation	CS	25°C	-	120	-	dB	-	

^{*7} Absolute value^{*8} Current direction: Since first input stage is composed with PNP transistor, input bias current flows out of IC.^{*9} Under high temperatures, please consider the power dissipation when selecting the output current.

When the output terminal is continuously shorted the output current reduces the internal temperature by flushing.

●Electrical Characteristics

OBA3472W (Unless otherwise specified VCC=+15V, VEE=-15V)

Parameter	Symbol	Temperature range	Limits			Unit	Condition		
			Min.	Typ.	Max.				
Input Offset Voltage ^{*10}	Vio	full range	-	-	7.5	mV	Vicm=0V, OUT=0V		
			-	-	7.5		VCC=5V VEE=0V	Vicm=0V OUT=VCC/2	
Input Offset Current ^{*10}	Iio	25°C	-	6	75	nA	Vicm=0V, OUT=0V		
		full range	-	-	100				
Input Bias Current ^{*11}	Ib	25°C	-	100	150	nA	Vicm=0V, OUT=0V		
		full range	-	-	200				
Supply Current	ICC	25°C	-	4	5	mA	RL=∞		
		full range	-	-	5.5				
Maximum Output Voltage(High)	VOH	25°C	3.7	4	-	V	VCC=5V VEE=0V	RL=2kΩ	
		full range	3.5	-	-				
		25°C	13.7	14	-		RL=10kΩ		
		full range	13.5	-	-				
		25°C	13.5	-	-		RL=2kΩ		
full range	-	-	-						
Maximum Output Voltage(Low)	VOL	25°C	-	0.1	0.3	V	VCC=5V VEE=0V	RL=2kΩ	
		full range	-	-	0.6				Isink=1mA
			-	-	0.3				
		25°C	-	-14.7	-14.3		RL=10kΩ		
		full range	-	-	-14.0				
		25°C	-	-	-13.5		RL=2kΩ		
full range	-	-	-						
Large Signal Voltage Gain	Av	25°C	80	100	-	dB	RL ≥ 2kΩ, OUT = ±10V		
		full range	70	-	-				
Input Common-mode Voltage Range	Vicm	25°C	0	-	VCC-2.0	V	VCC=5V VEE=0V	OUT=VCC/2	
		full range	0	-	VCC-2.6				
Common-mode Rejection Ratio	CMRR	25°C	60	97	-	dB	OUT=0V		
Power Supply Rejection Ratio	PSRR	25°C	60	97	-	dB	Vicm=0V, OUT=0V		
Output Source Current ^{*12}	Isource	25°C	10	30	-	mA	VCC=5V VEE=0V	IN+=1V IN-=0V OUT=0V Only 1ch is short circuit	
		full range	10	-	-				
Output Sink Current ^{*12}	Isink	25°C	20	30	-	mA	VCC=5V VEE=0V	IN+=0V IN-=1V OUT=5V Only 1ch is short circuit	
		full range	20	-	-				
Gain Band Width	GBW	25°C	-	4	-	MHz	-		
Slew Rate	SR	25°C	-	10	-	V/μs	Av=1, IN=-10V to +10V RL=2kΩ		
		full range	5	-	-				
Channel Separation	CS	25°C	-	120	-	dB	-		

*10 Absolute value

*11 Current direction: Since first input stage is composed with PNP transistor, input bias current flows out of IC.

*12 Under high temperatures, please consider the power dissipation when selecting the output current.

When the output terminal is continuously shorted the output current reduces the internal temperature by flushing.

●Electrical Characteristics

OBA3474Y (Unless otherwise specified VCC=+15V, VEE=-15V)

Parameter	Symbol	Temperature range	Limits			Unit	Condition	
			Min.	Typ.	Max.			
Input Offset Voltage ^{*13}	Vio	full range	-	-	10	mV	Vicm=0V, OUT=0V	
			-	-	10		VCC=5V VEE=0V	Vicm=0V OUT=VCC/2
Input Offset Current ^{*13}	Iio	25°C	-	6	75	nA	Vicm=0V, OUT=0V	
		full range	-	-	100			
Input Bias Current ^{*14}	Ib	25°C	-	100	150	nA	Vicm=0V, OUT=0V	
		full range	-	-	200			
Supply Current	ICC	25°C	-	8	10	mA	RL=∞	
		full range	-	-	9		VCC=15V, RL=∞	
			-	-	11		RL=∞	
Maximum Output Voltage(High)	VOH	25°C	3.7	4	-	V	VCC=5V VEE=0V	RL=2kΩ
		full range	3.5	-	-			
		25°C	13.7	14	-		RL=10kΩ	
		full range	13.5	-	-			
		25°C	13.5	-	-		RL=2kΩ	
Maximum Output Voltage(Low)	VOL	25°C	-	0.1	0.3	V	VCC=5V VEE=0V	RL=2kΩ
		full range	-	-	0.6			
		25°C	-	-14.7	-14.3		RL=10kΩ	
		full range	-	-	-14.0			
		25°C	-	-	-13.5		RL=2kΩ	
Large Signal Voltage Gain	Av	25°C	80	100	-	dB	RL ≥ 2kΩ, OUT = ±10V	
		full range	70	-	-			
Input Common-mode Voltage Range	Vicm	25°C	0	-	VCC-2.0	V	VCC=5V VEE=0V	OUT=VCC/2
		full range	0	-	VCC-2.6			
Common-mode Rejection Ratio	CMRR	25°C	60	97	-	dB	OUT=0V	
Power Supply Rejection Ratio	PSRR	25°C	60	97	-	dB	Vicm=0V, OUT=0V	
Output Source Current ^{*15}	Isource	25°C	10	30	-	mA	VCC=5V VEE=0V	IN+=1V IN-=0V OUT=0V Only 1ch is short circuit
		full range	10	-	-			
Output Sink Current ^{*15}	Isink	25°C	20	30	-	mA	VCC=5V VEE=0V	IN+=0V IN-=1V OUT=5V Only 1ch is short circuit
		full range	20	-	-			
Gain Band Width	GBW	25°C	-	4	-	MHz	-	
Slew Rate	SR	25°C	-	10	-	V/μs	Av=1, IN=-10V to +10V RL=2kΩ	
		full range	5	-	-			
Channel Separation	CS	25°C	-	120	-	dB	-	

*13 Absolute value

*14 Current direction: Since first input stage is composed with PNP transistor, input bias current flows out of IC.

*15 Under high temperatures, please consider the power dissipation when selecting the output current.

When the output terminal is continuously shorted the output current reduces the internal temperature by flushing.

● Electrical Characteristics

OBA3474W (Unless otherwise specified VCC=+15V, VEE=-15V)

Parameter	Symbol	Temperature range	Limits			Unit	Condition	
			Min.	Typ.	Max.			
Input Offset Voltage ^{*16}	Vio	full range	-	-	7.5	mV	Vicm=0V, OUT=0V	
			-	-	7.5		VCC=5V VEE=0V	Vicm=0V OUT=VCC/2
Input Offset Current ^{*16}	Iio	25°C	-	6	75	nA	Vicm=0V, OUT=0V	
		full range	-	-	100			
Input Bias Current ^{*17}	Ib	25°C	-	100	150	nA	Vicm=0V, OUT=0V	
		full range	-	-	200			
Supply Current	ICC	25°C	-	8	10	mA	RL=∞	
		full range	-	-	9		VCC=15V, RL=∞	
			-	-	11		RL=∞	
Maximum Output Voltage(High)	VOH	25°C	3.7	4	-	V	VCC=5V VEE=0V	RL=2kΩ
		full range	3.5	-	-			RL=10kΩ
		25°C	13.7	14	-			
		full range	13.5	-	-			
		25°C	13.5	-	-		RL=2kΩ	
Maximum Output Voltage(Low)	VOL	25°C	-	0.1	0.3	V	VCC=5V VEE=0V	RL=2kΩ
		full range	-	-	0.6			I sink=1mA
			-	-	0.3			
		25°C	-	-14.7	-14.3		RL=10kΩ	
		full range	-	-	-14.0			
25°C	-	-	-13.5	RL=2kΩ				
Large Signal Voltage Gain	Av	25°C	80	100	-	dB	RL ≥ 2kΩ, OUT = ±10V	
		full range	70	-	-			
Input Common-mode Voltage Range	Vicm	25°C	0	-	VCC-2.0	V	VCC=5V VEE=0V	OUT=VCC/2
		full range	0	-	VCC-2.6			
Common-mode Rejection Ratio	CMRR	25°C	60	97	-	dB	OUT=0V	
Power Supply Rejection Ratio	PSRR	25°C	60	97	-	dB	Vicm=0V, OUT=0V	
Output Source Current ^{*18}	Isource	25°C	10	30	-	mA	VCC=5V VEE=0V	IN+=1V IN-=0V OUT=0V Only 1ch is short circuit
		full range	10	-	-			
Output Sink Current ^{*18}	Isink	25°C	20	30	-	mA	VCC=5V VEE=0V	IN+=0V IN-=1V OUT=5V Only 1ch is short circuit
		full range	20	-	-			
Gain Band Width	GBW	25°C	-	4	-	MHz	-	
Slew Rate	SR	25°C	-	10	-	V/μs	Av=1, IN=-10V to +10V RL=2kΩ	
		full range	5	-	-			
Channel Separation	CS	25°C	-	120	-	dB	-	

*16 Absolute value

*17 Current direction: Since first input stage is composed with PNP transistor, input bias current flows out of IC.

*18 Under high temperatures, please consider the power dissipation when selecting the output current.

When the output terminal is continuously shorted the output current reduces the internal temperature by flushing.

Description of Electrical Characteristics

Described below are descriptions of the relevant electrical terms used in this datasheet. Items and symbols used are also shown. Note that item name and symbol and their meaning may differ from those on another manufacturer's document or general document.

1. Absolute maximum ratings

Absolute maximum rating items indicate the condition which must not be exceeded. Application of voltage in excess of absolute maximum rating or use out of absolute maximum rated temperature environment may cause deterioration of characteristics.

1.1 Power supply voltage (VCC-VEE)

Indicates the maximum voltage that can be applied between the positive power supply terminal and negative power supply terminal without deterioration or destruction of characteristics of internal circuit.

1.2 Differential input voltage (V_{id})

Indicates the maximum voltage that can be applied between non-inverting and inverting terminals without damaging the IC.

1.3 Input common-mode voltage range (V_{icm})

Indicates the maximum voltage that can be applied to the non-inverting and inverting terminals without deterioration or destruction of electrical characteristics. Input common-mode voltage range of the maximum ratings does not assure normal operation of IC. For normal operation, use the IC within the input common-mode voltage range characteristics.

1.4 Power dissipation (P_d)

Indicates the power that can be consumed by the IC when mounted on a specific board at the ambient temperature 25°C (normal temperature). As for package product, P_d is determined by the temperature that can be permitted by the IC in the package (maximum junction temperature) and the thermal resistance of the package.

2. Electrical characteristics

2.1 Input offset voltage (V_{io})

Indicates the voltage difference between non-inverting terminal and inverting terminals. It can be translated into the input voltage difference required for setting the output voltage at 0 V.

2.2 Input offset current (I_{io})

Indicates the difference of input bias current between the non-inverting and inverting terminals.

2.3 Input bias current (I_b)

Indicates the current that flows into or out of the input terminal. It is defined by the average of input bias currents at the non-inverting and inverting terminals.

2.4 Circuit current (I_{CC})

Indicates the current that flows within the IC under specified no-load conditions.

2.5 High level output voltage/low level output voltage (V_{OH}/V_{OL})

Indicates the voltage range of the output under specified load condition. It is typically divided into high-level output voltage and low-level output voltage. High-level output voltage indicates the upper limit of output voltage while Low-level output voltage indicates the lower limit.

2.6 Large signal voltage gain (A_v)

Indicates the amplifying rate (gain) of output voltage against the voltage difference between non-inverting terminal and inverting terminal. It is normally the amplifying rate (gain) with reference to DC voltage.

$$A_v = (\text{Output voltage fluctuation}) / (\text{Input offset fluctuation})$$

2.7 Input common-mode voltage range (V_{icm})

Indicates the input voltage range where IC normally operates.

2.8 Common-mode rejection ratio (CMRR)

Indicates the ratio of fluctuation of input offset voltage when the input common mode voltage is changed. It is normally the fluctuation of DC.

$$\text{CMRR} = (\text{Change of Input common-mode voltage}) / (\text{Input offset fluctuation})$$

2.9 Power supply rejection ratio (PSRR)

Indicates the ratio of fluctuation of input offset voltage when supply voltage is changed. It is normally the fluctuation of DC.

$$\text{PSRR} = (\text{Change of power supply voltage}) / (\text{Input offset fluctuation})$$

2.10 Output source current/ output sink current (IOH / IOL)

The maximum current that can be output from the IC under specific output conditions. The output source current indicates the current flowing out from the IC, and the output sink current indicates the current flowing into the IC.

2.11 Gain Band Width (GBW)

The product of the open-loop voltage gain and the frequency at which the voltage gain decreases 6dB/octave.

2.12 Slew rate (SR)

Indicates the ratio of the change in output voltage with time when a step input signal is applied.

2.13 Channel separation (CS)

Indicates the fluctuation in the output voltage of the driven channel with reference to the change of output voltage of the channel which is not driven.

● Typical Performance Curves

OBA3472Y, BA3472W

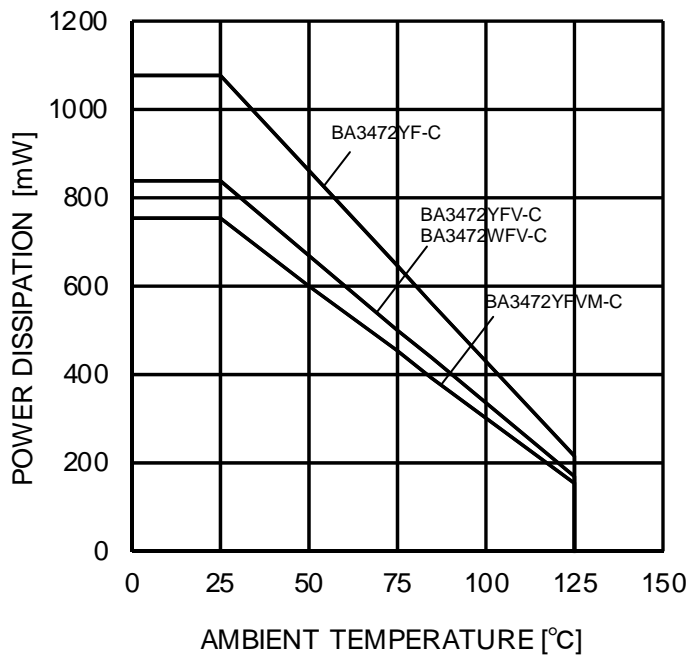

Figure 2.
Derating Curve

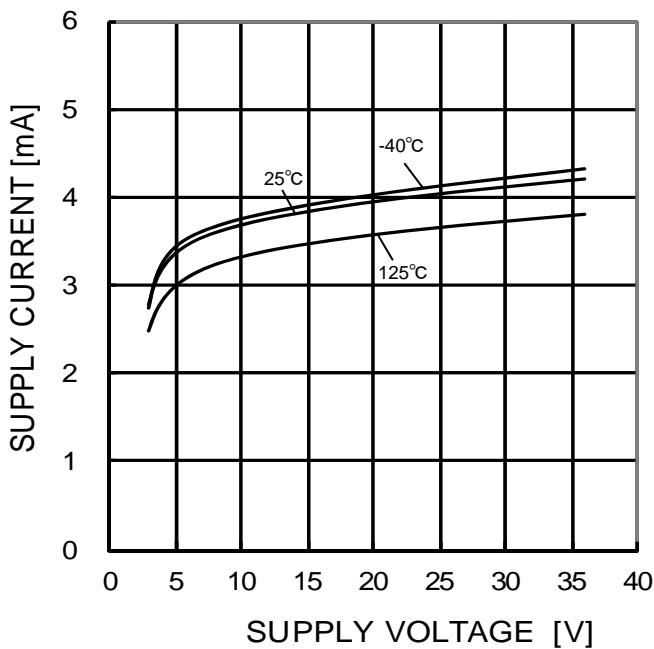

Figure 3.
Supply Current - Supply Voltage

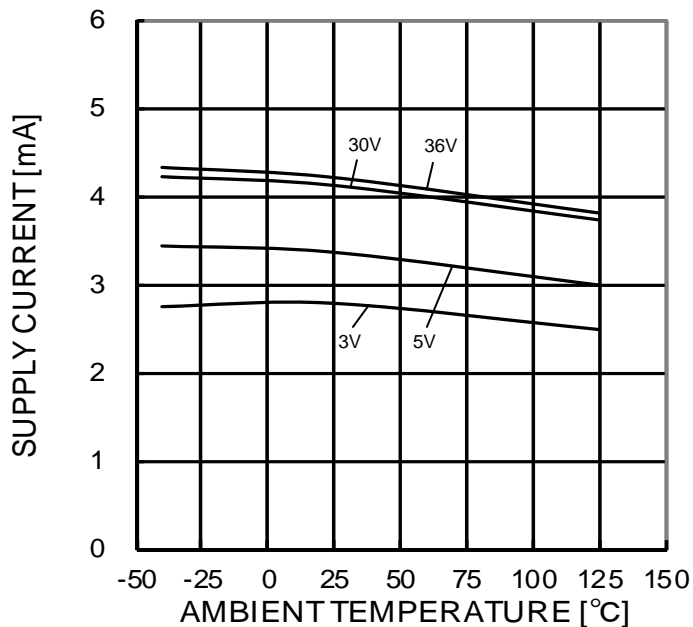

Figure 4.
Supply Current - Ambient Temperature

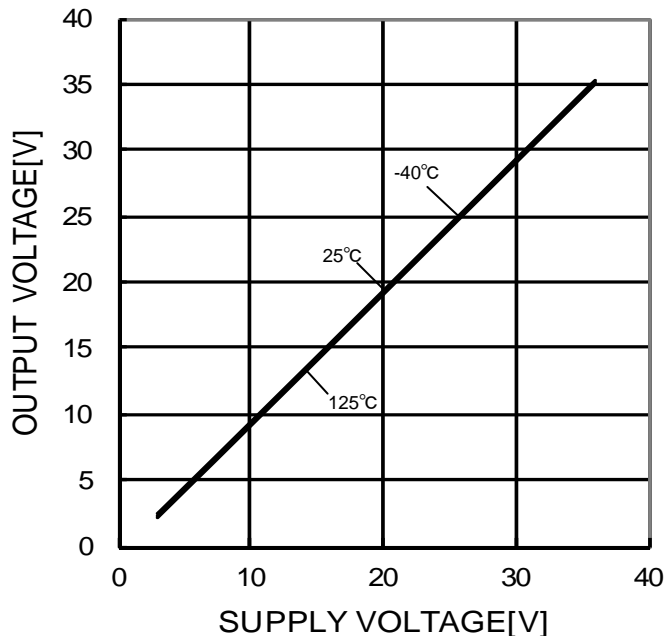

Figure 5.
Maximum Output Voltage(High)
- Supply Voltage
(RL=10kΩ)

(*The above data is measurement value of typical sample, it is not guaranteed.

OBA3472Y, BA3472W

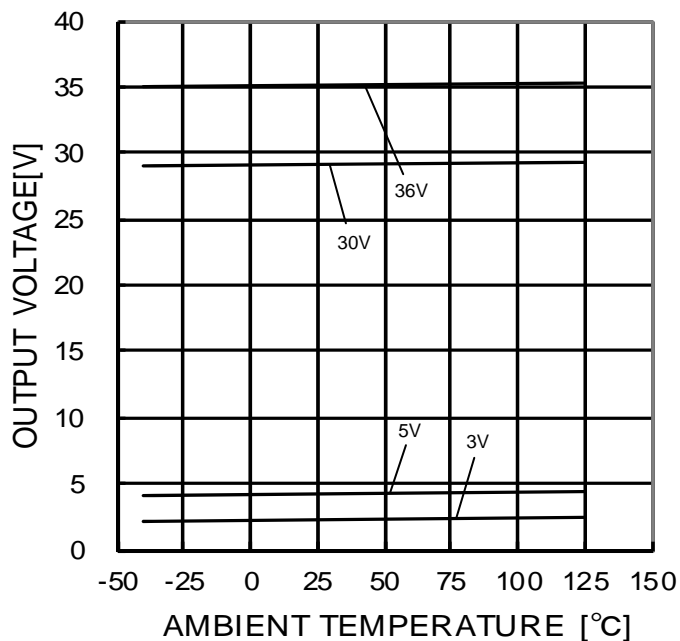

Figure 6.
Maximum Output Voltage(High)
- Ambient Temperature
(RL=10kΩ)

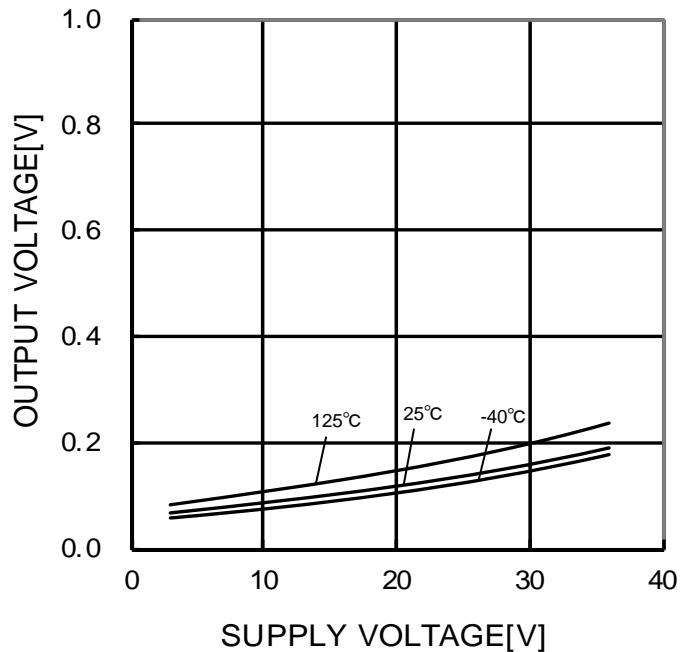

Figure 7.
Maximum Output Voltage(Low)
- Supply Voltage
(RL=10kΩ)

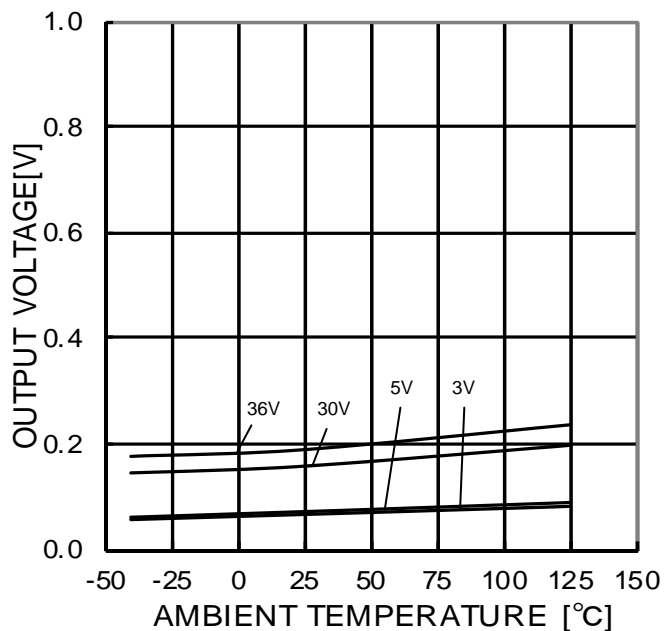

Figure 8.
Maximum Output Voltage(Low)
- Ambient Temperature
(RL=10kΩ)

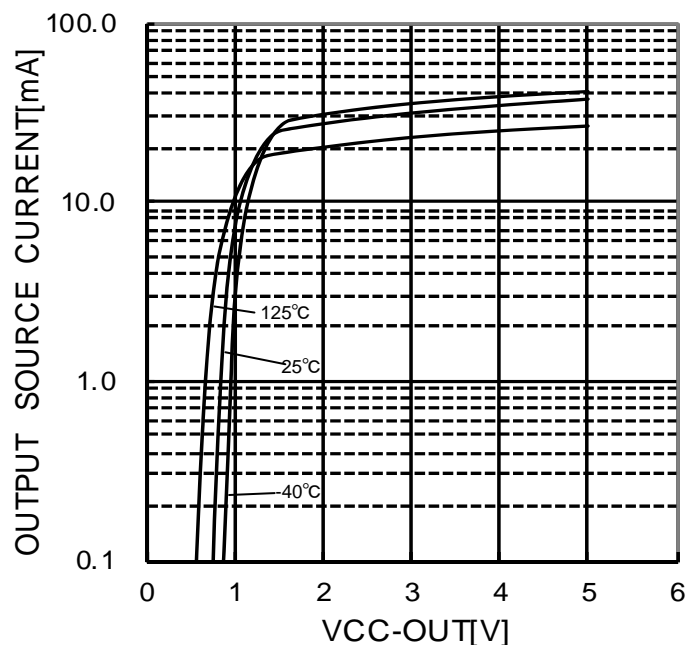

Figure 9.
Output Source Current - (VCC-OUT)
(VCC/VEE=5V/0V)

(*The above data is measurement value of typical sample, it is not guaranteed.

OBA3472Y, BA3472W

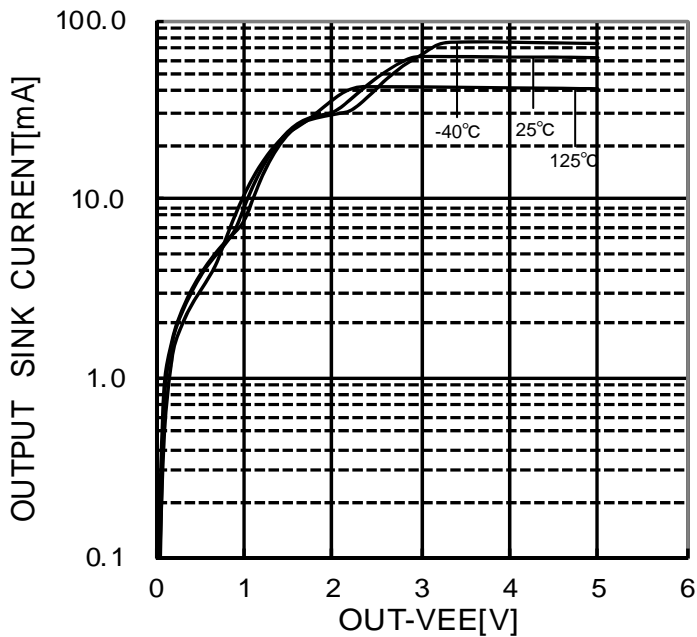

Figure 10.
Output Source Current - (OUT-VEE)
(VCC/VEE=5V/0V)

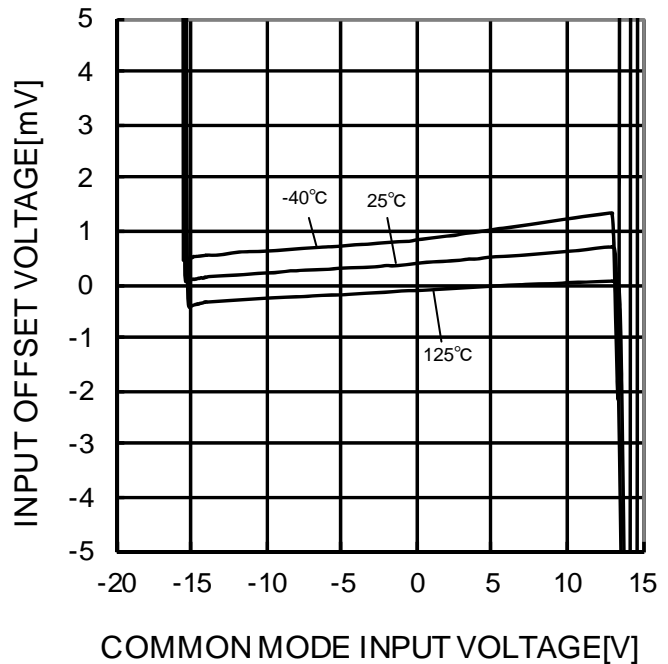

Figure 11.
Input Offset Voltage
- Common Mode Input Voltage
(VCC/VEE=15V/-15V)

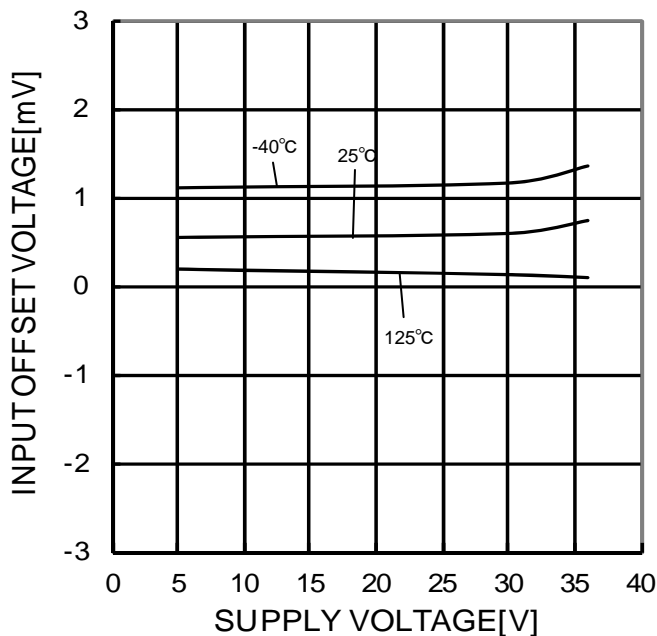

Figure 12.
Input Offset Voltage - Supply voltage

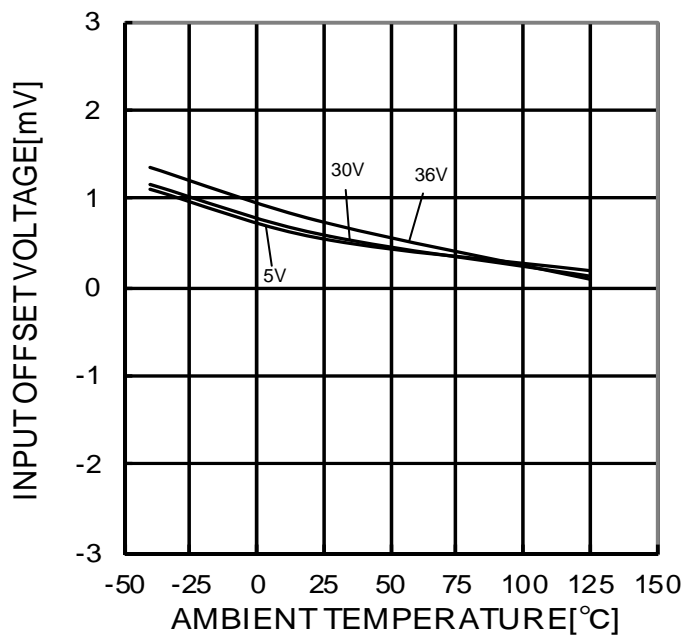

Figure 13.
Input Offset Voltage - Ambient Temperature

(*)The above data is measurement value of typical sample, it is not guaranteed.

OBA3472Y, BA3472W

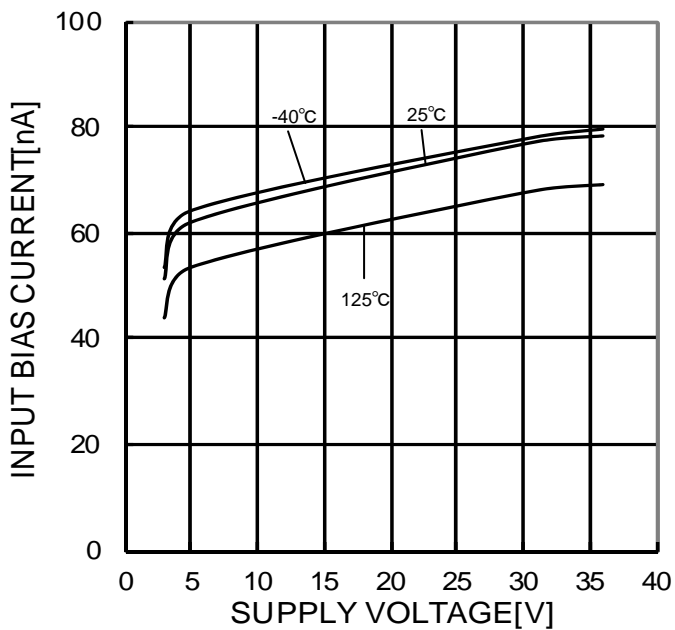

Figure 14.
Input Bias Current - Supply Voltage

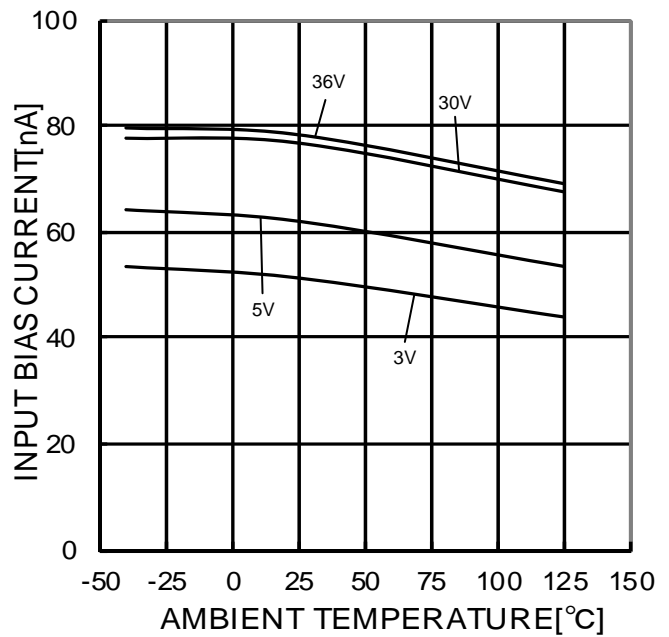

Figure 15.
Input Bias Current - Ambient Temperature

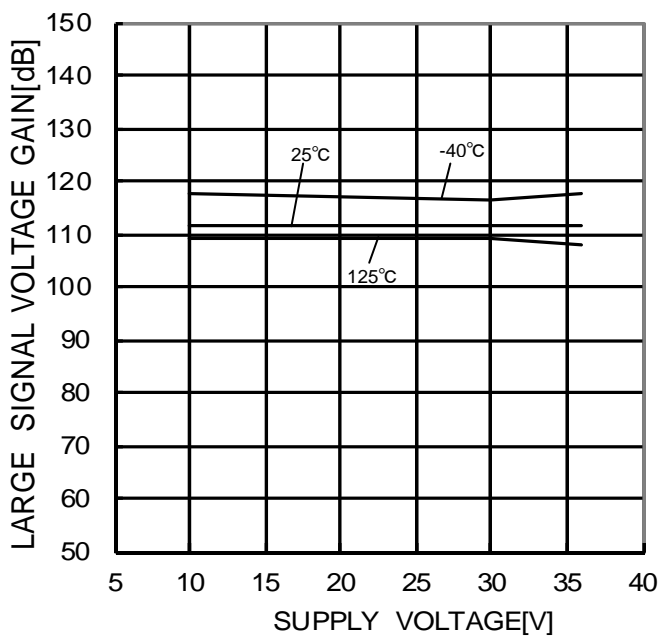

Figure 16.
Large Signal Voltage Gain
- Supply Voltage

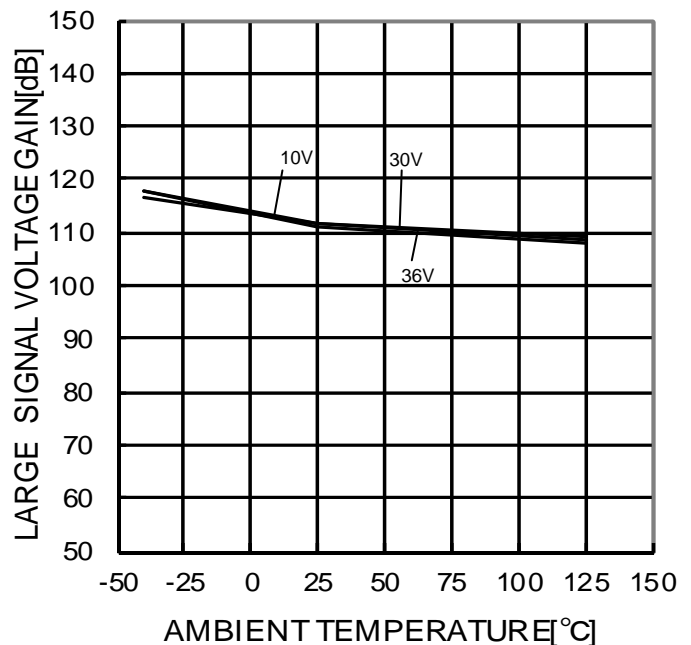

Figure 17.
Large Signal Voltage Gain
- Ambient Temperature

(*The above data is measurement value of typical sample, it is not guaranteed.

OBA3472Y, BA3472W

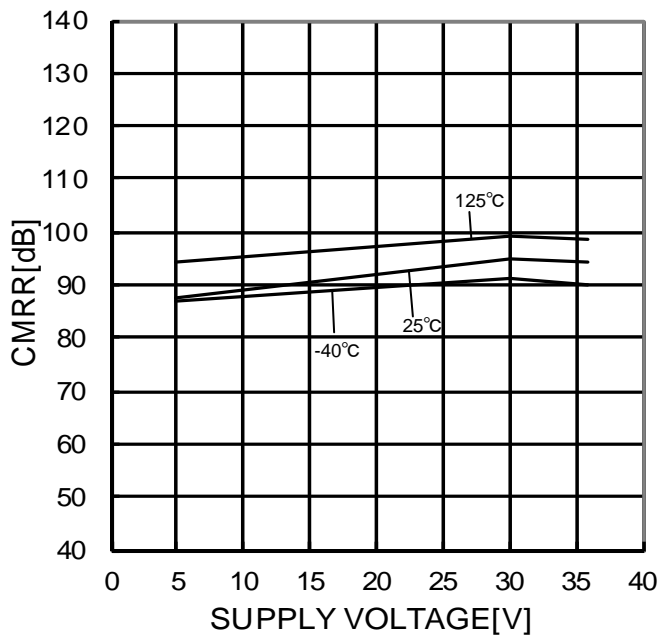

Figure 18.
Common Mode Rejection Ratio
- Supply Voltage

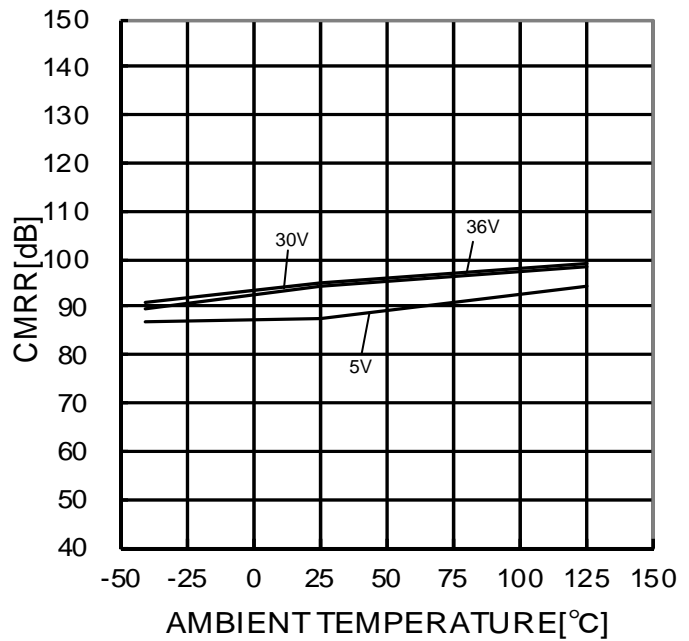

Figure 19.
Common Mode Rejection Ratio
- Ambient Temperature

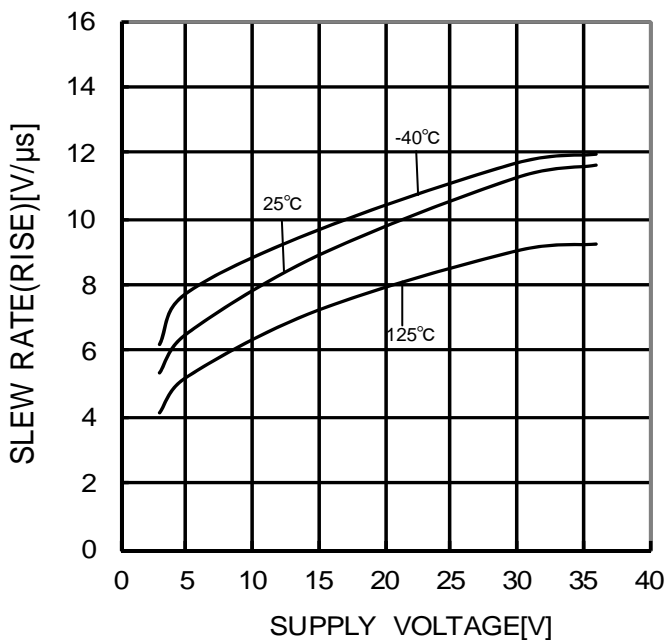

Figure 20.
Slew Rate L-H - Supply Voltage
(RL=10kΩ)

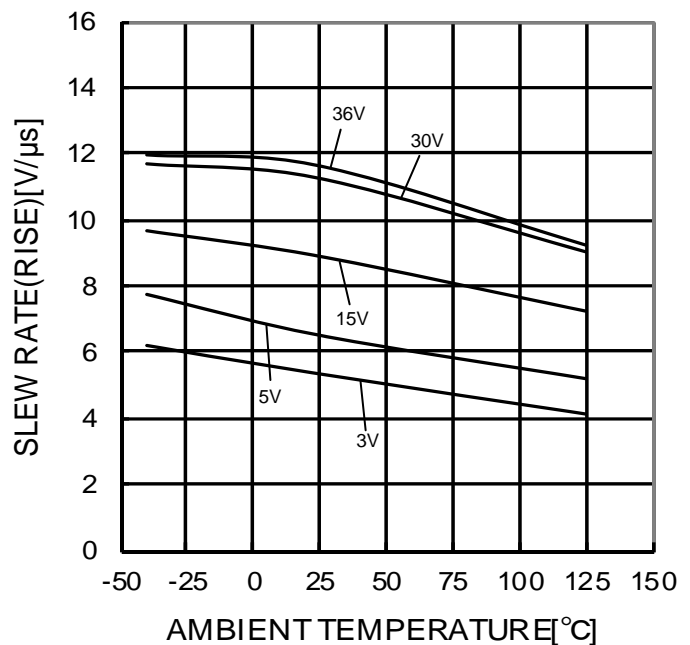

Figure 21.
Slew Rate L-H Ambient Temperature
(RL=10kΩ)

(*The above data is measurement value of typical sample, it is not guaranteed.

OBA3472Y, BA3472W

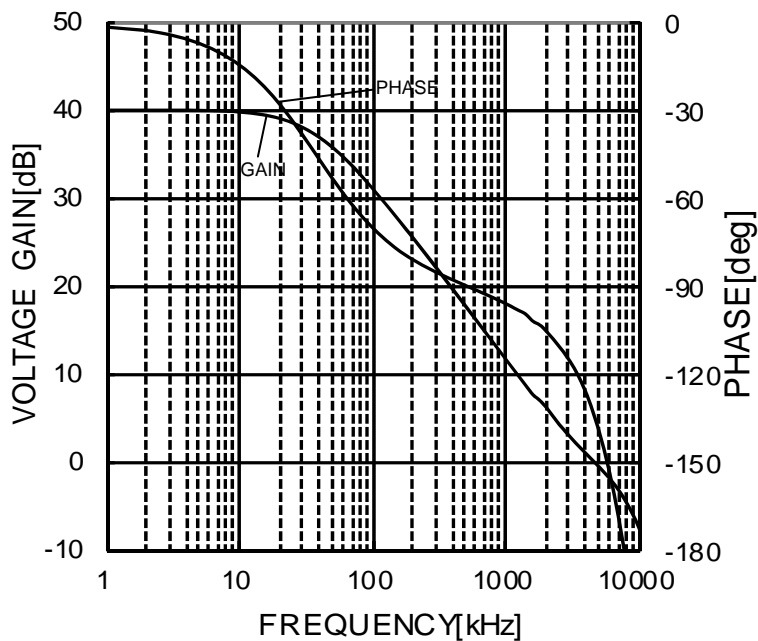

Figure 22.
Voltage Gain · Phase - Frequency
(VCC/VEE=+15V/-15V, Av=40dB
RL=2kΩ, CL=100pF, Ta=25°C)

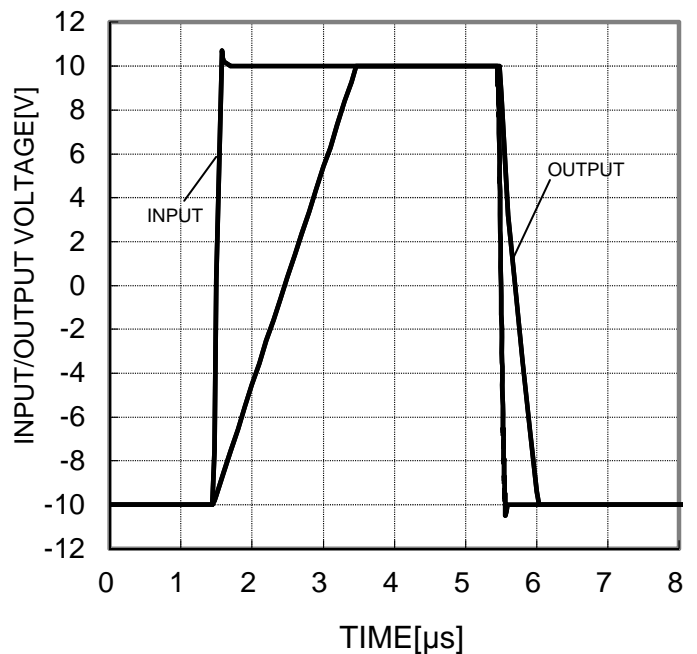

Figure 23.
Input / Output Voltage - Time
(VCC/VEE=+15V/-15V, Av=0dB,
RL=2kΩ, CL=100pF, Ta=25°C)

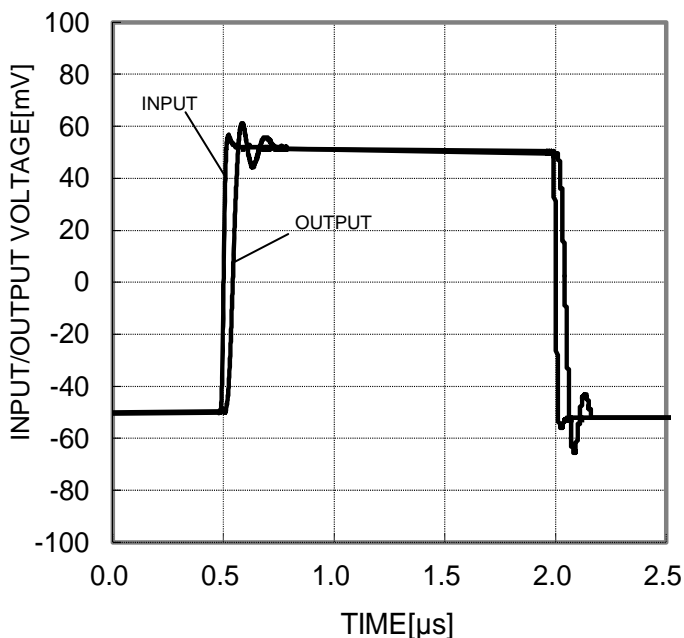

Figure 24.
Input / Output Voltage - Time
(VCC/VEE=+15V/-15V, Av=0dB,
RL=2kΩ, CL=100pF, Ta=25°C)

(*)The above data is measurement value of typical sample, it is not guaranteed.

OBA3474Y, BA3474W

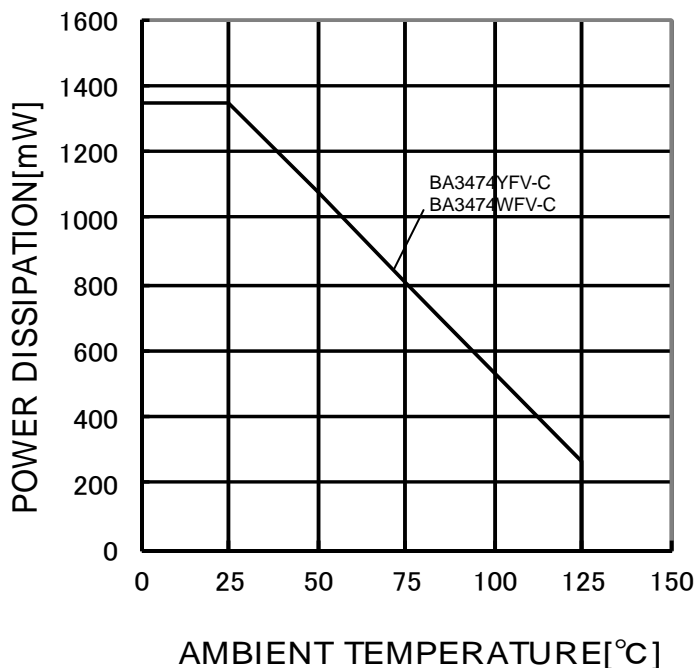

Figure 25.
Derating Curve

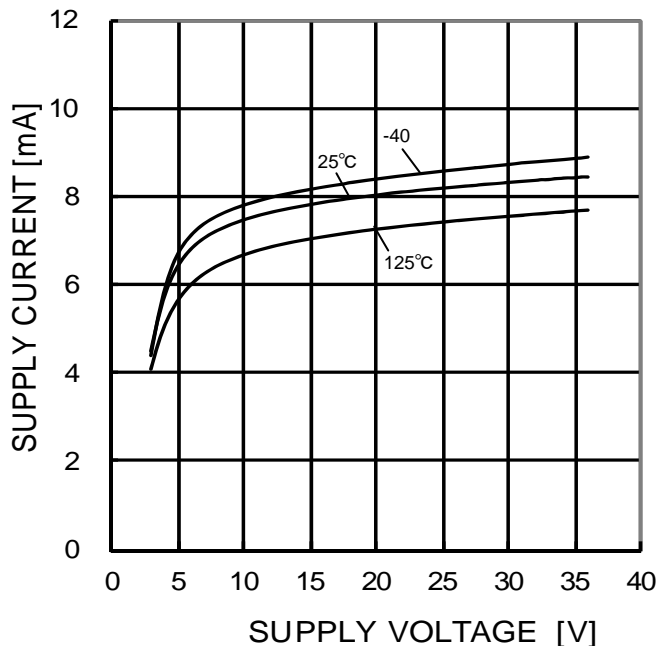

Figure 26.
Supply Current - Supply Voltage

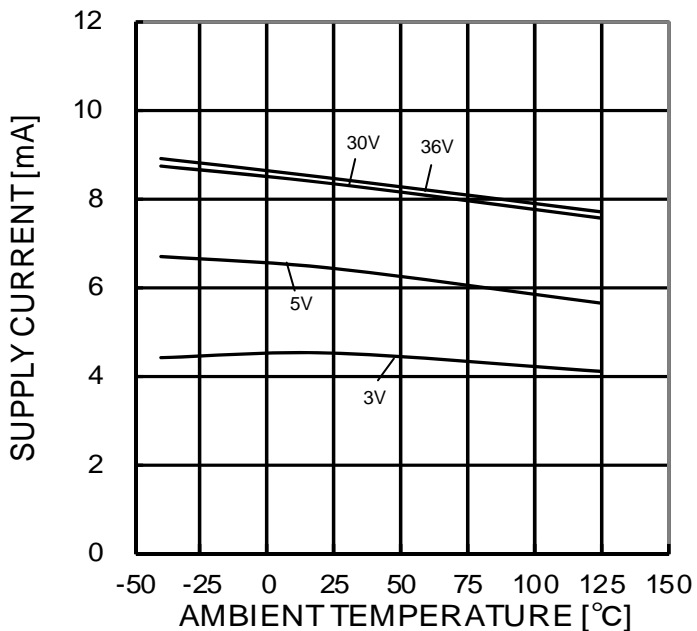

Figure 27.
Supply Current - Ambient Temperature

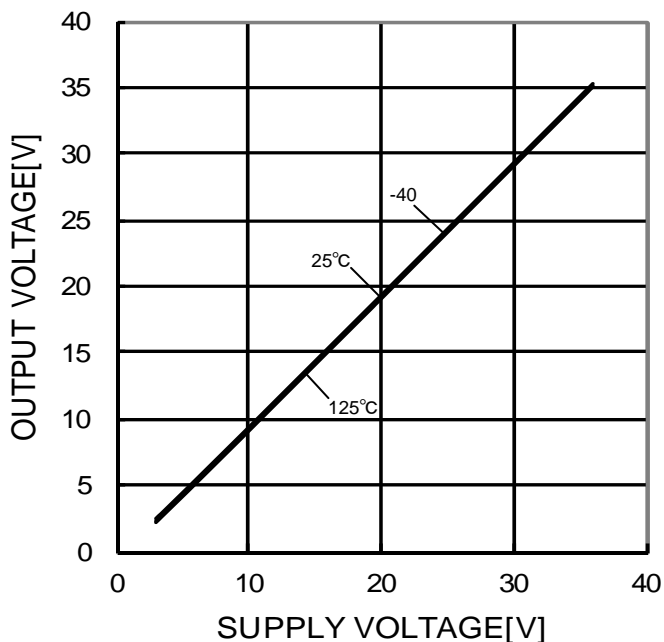

Figure 28.
Maximum Output Voltage(High)
- Supply Voltage
($R_L=10k\Omega$)

(*The above data is measurement value of typical sample, it is not guaranteed.

OBA3474Y, BA3474W

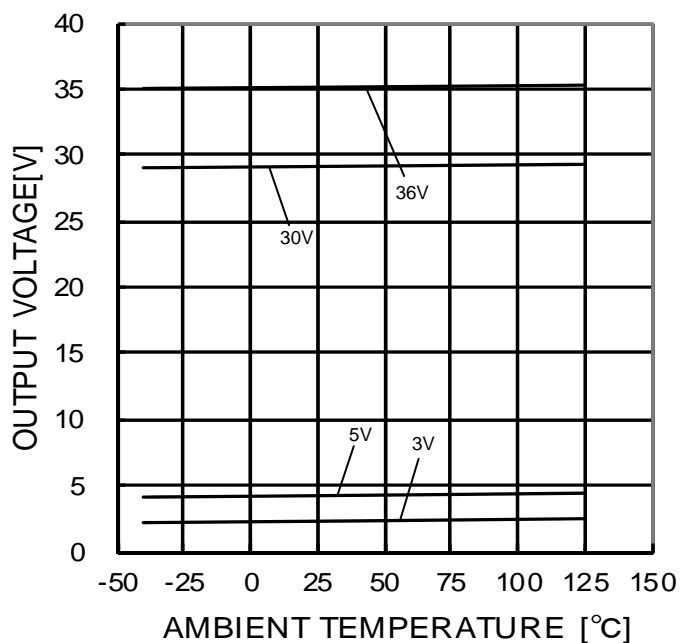

Figure 29.
Maximum Output Voltage(High)
- Ambient Temperature (RL=10kΩ)

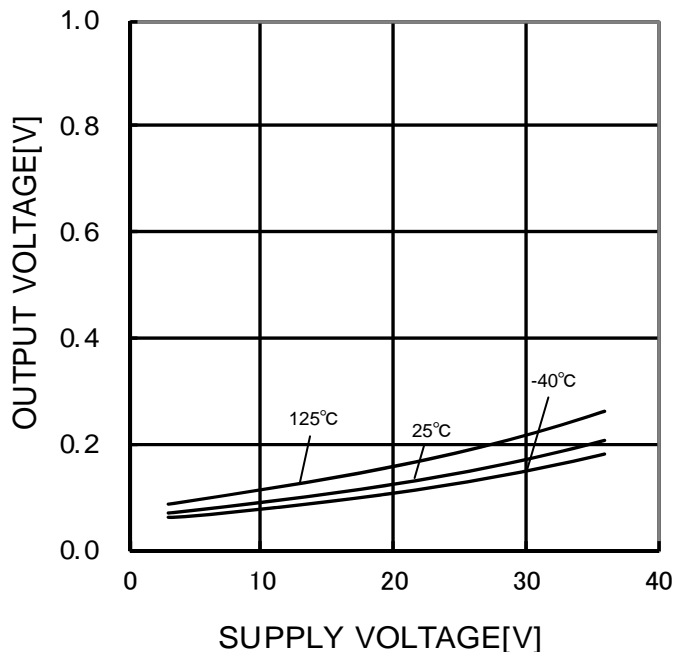

Figure 30.
Maximum Output Voltage(Low)
- Supply Voltage (RL=10kΩ)

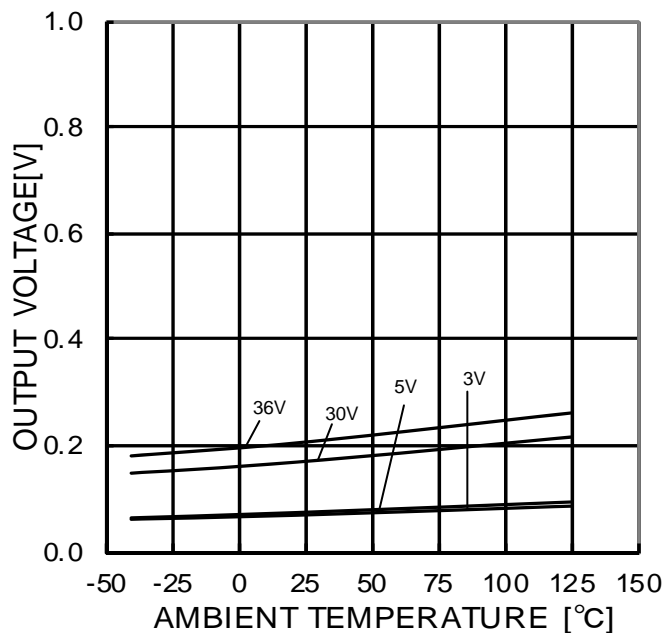

Figure 31.
Maximum Output Voltage(Low)
- Ambient Temperature (RL=10kΩ)

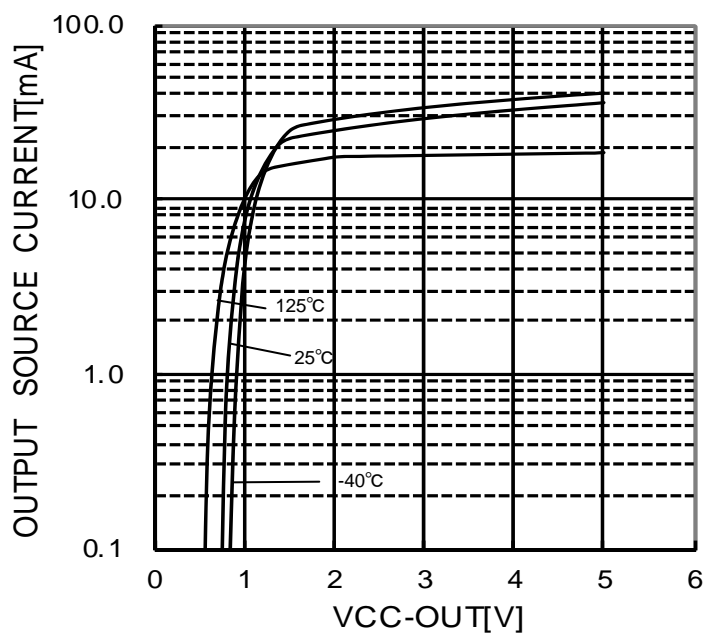

Figure 32.
Output Source Current - (VCC-OUT)
(VCC/VEE=5V/0V)

(*The above data is measurement value of typical sample, it is not guaranteed.

OBA3474Y, BA3474W

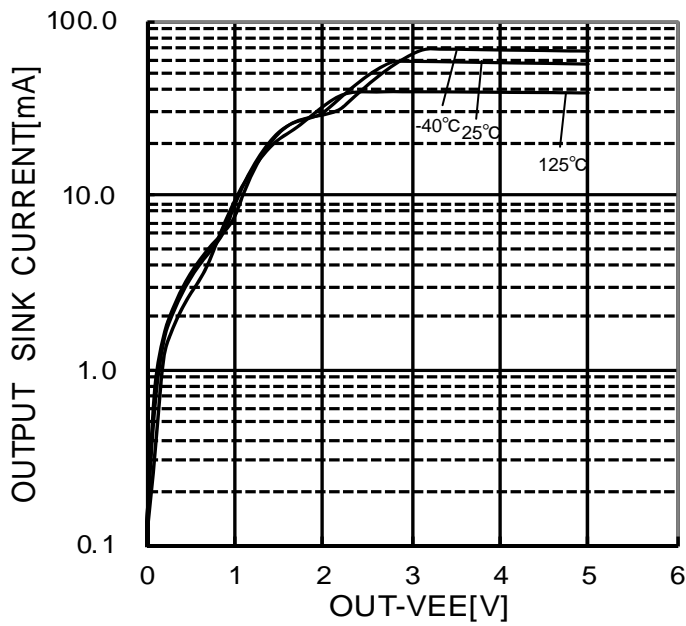

Figure 33.
Output Source Current - (OUT-VEE)
(VCC/VEE=5V/0V)

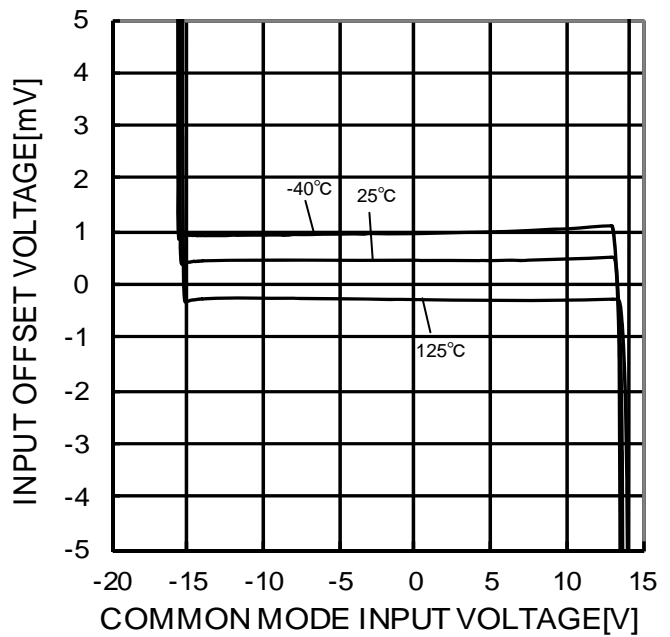

Figure 34.
Input Offset Voltage -
Common Mode Input Voltage
(VCC/VEE=15V/-15V)

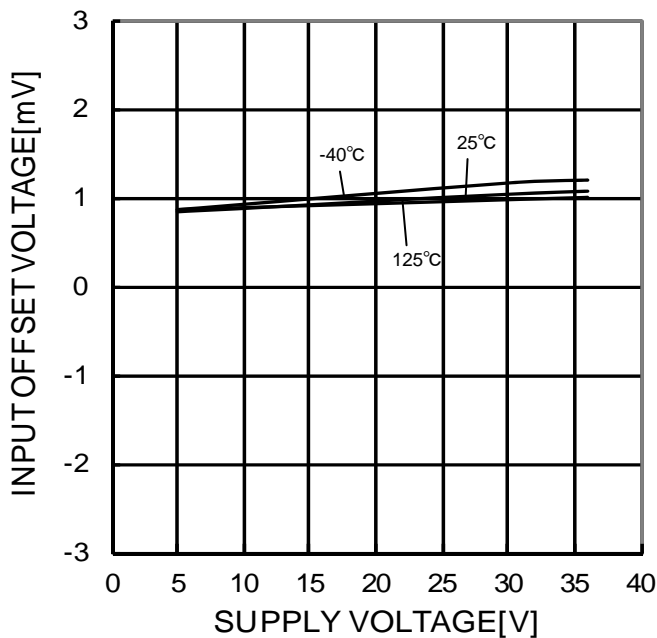

Figure 35.
Input Offset Voltage - Supply Voltage

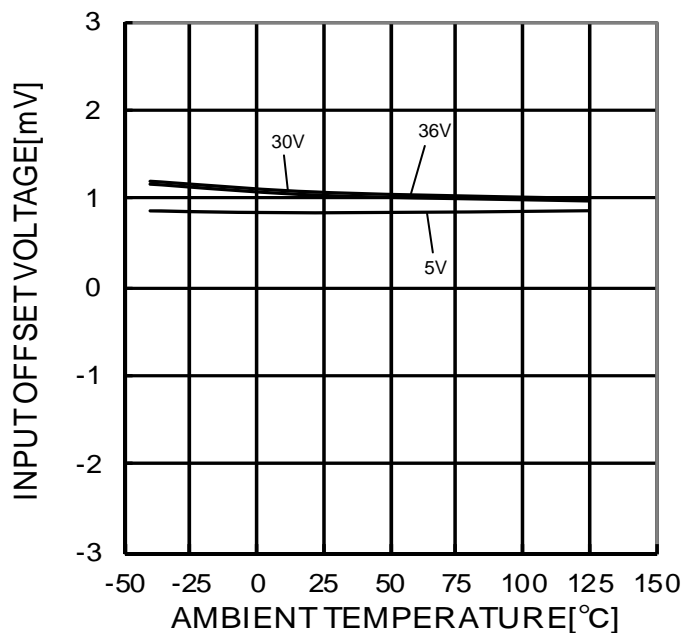

Figure 36.
Input Offset Voltage - Ambient Temperature

(*The above data is measurement value of typical sample, it is not guaranteed.

OBA3474Y, BA3474W

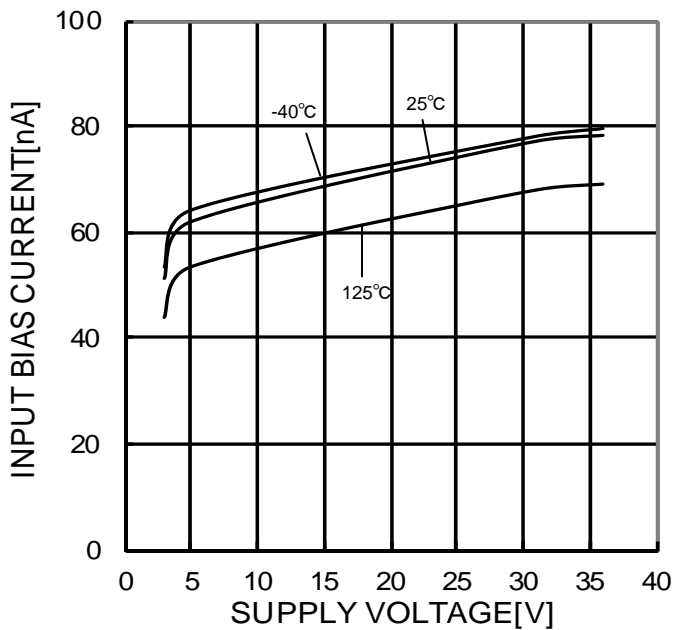

Figure 37.
Input Bias Current - Supply Voltage

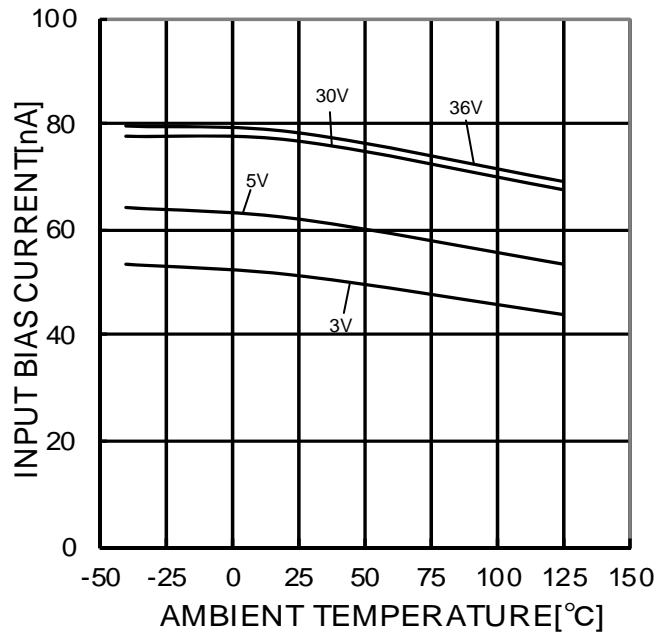

Figure 38.
Input Bias Current - Ambient Temperature

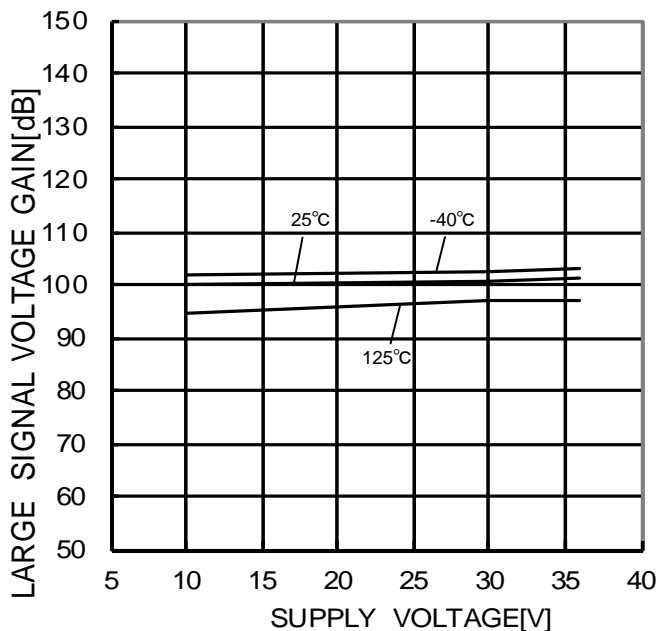

Figure 39.
Large Signal Voltage Gain
- Supply Voltage

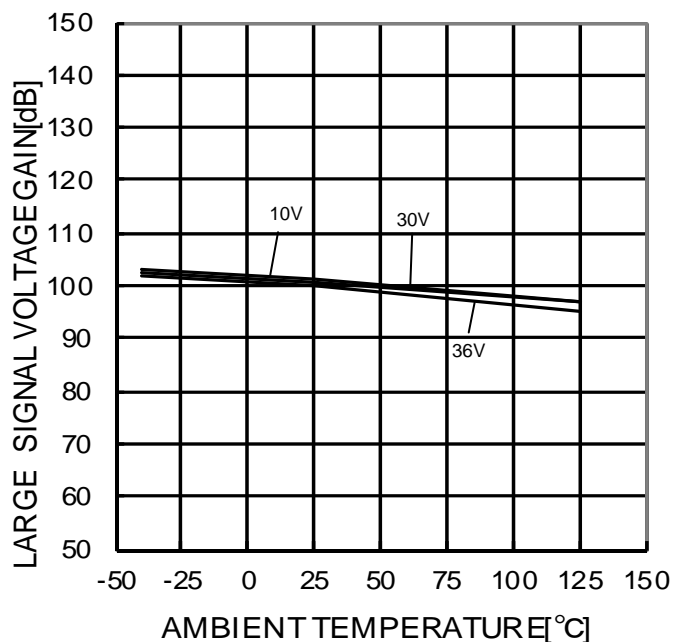

Figure 40.
Large Signal Voltage Gain
- Ambient Temperature

(*The above data is measurement value of typical sample, it is not guaranteed.

OBA3474Y, BA3474W

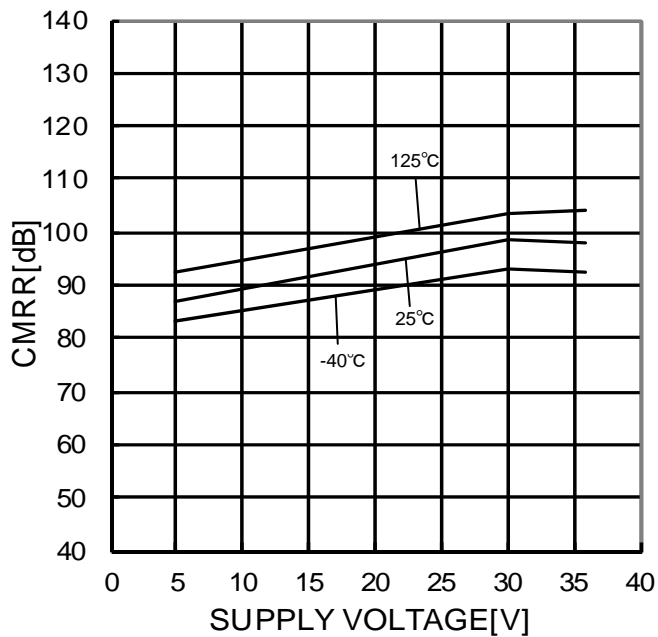

Figure 41.
Common Mode Rejection Ratio
- Supply Voltage

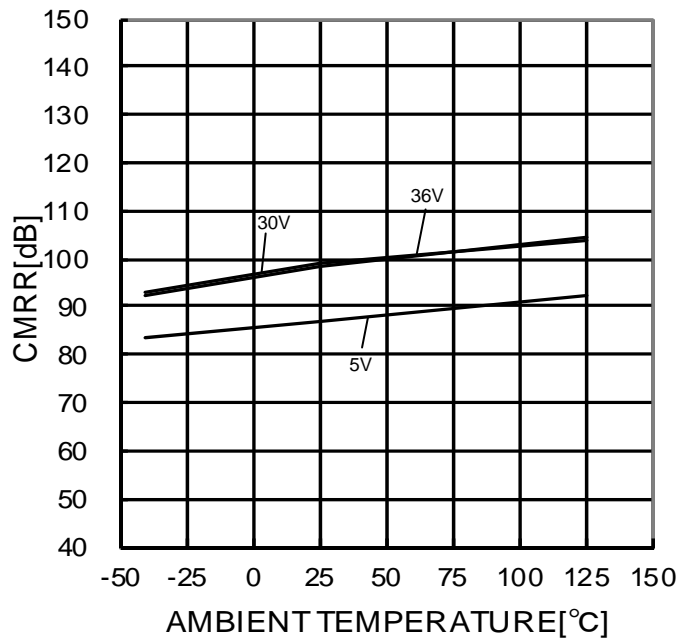

Figure 42.
Common Mode Rejection Ratio
- Ambient Temperature

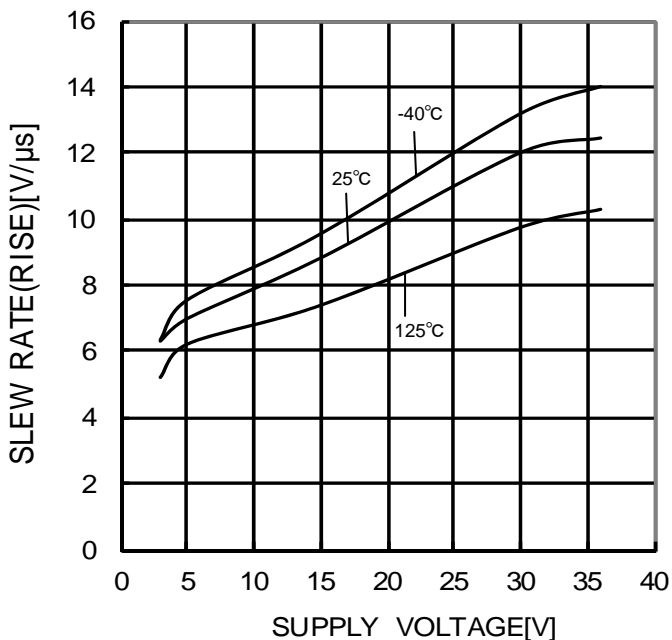

Figure 43.
Slew Rate L-H - Supply Voltage
RL=10kΩ

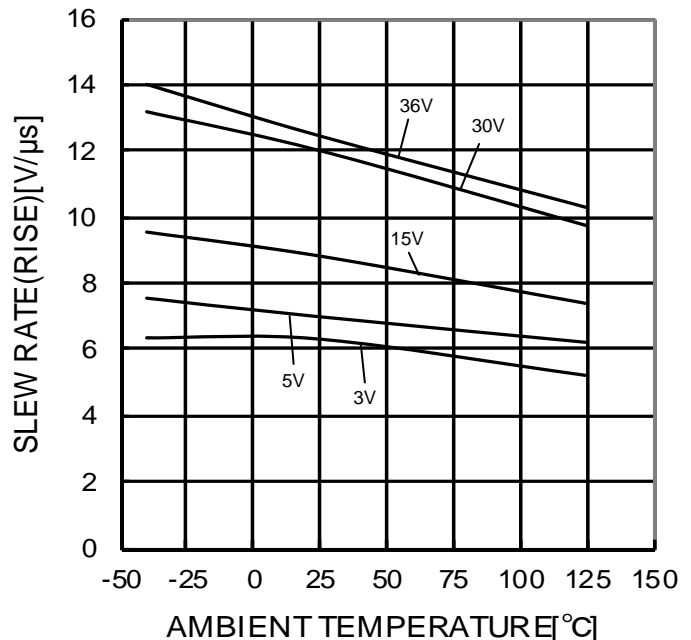

Figure 44.
Slew Rate L-H Ambient Temperature
RL=10kΩ

(*The above data is measurement value of typical sample, it is not guaranteed.

OBA3474Y, BA3474W

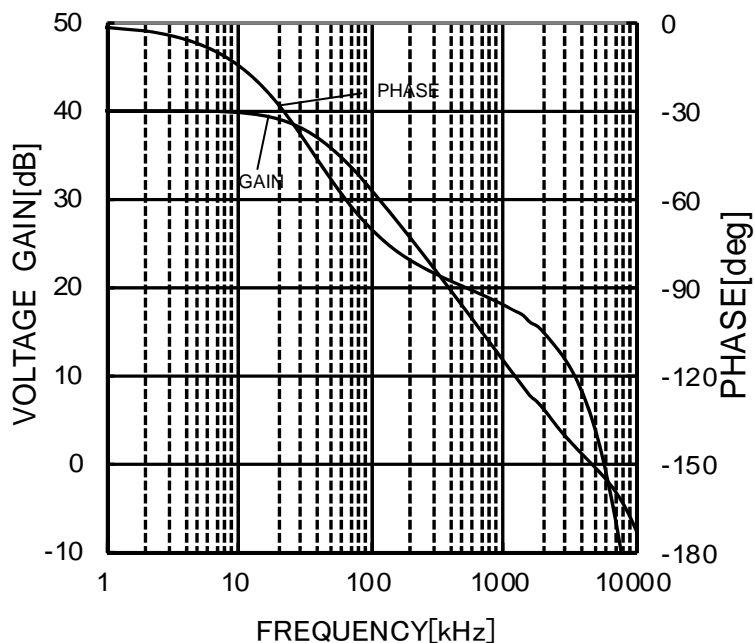

Figure 45.
Voltage Gain · Phase - Frequency
(VCC/VEE=+15V/-15V, Av=40dB, RL=2kΩ, CL=100pF, Ta=25°C)

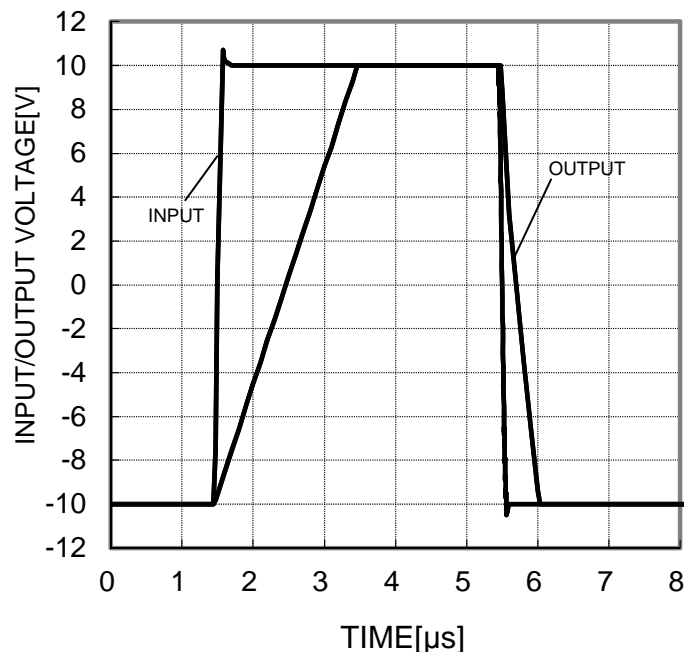

Figure 46.
Input / Output Voltage - Time
(VCC/VEE=+15V/-15V, Av=0dB, RL=2kΩ, CL=100pF, Ta=25°C)

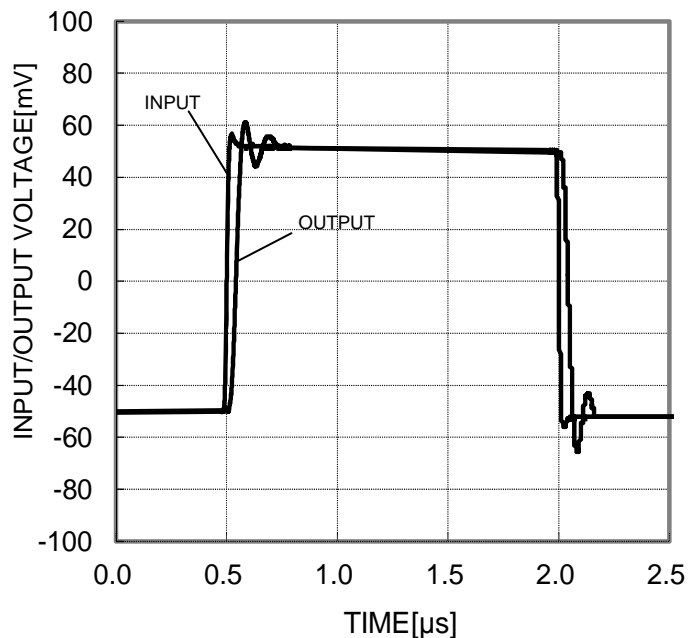

Figure 47.
Input / Output Voltage - Time
(VCC/VEE=+15V/-15V, Av=0dB, RL=2kΩ, CL=100pF, Ta=25°C)

(*)The above data is measurement value of typical sample, it is not guaranteed.

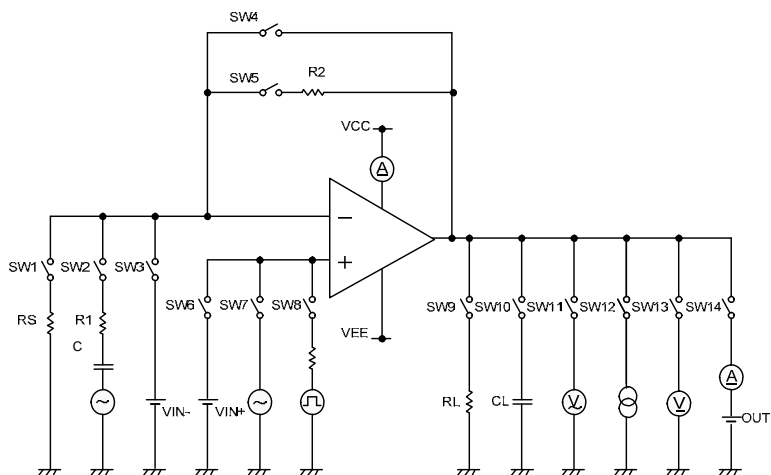

Figure 49. Test Circuit 2 (each Op-Amp)

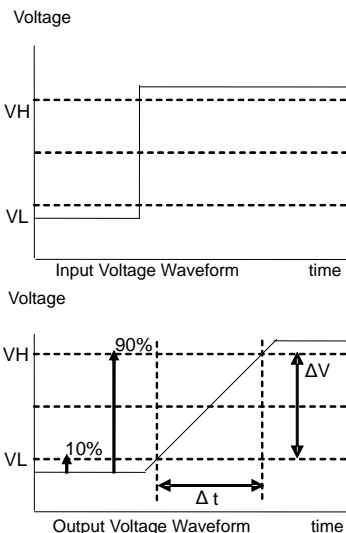

Figure 50. Slew rate input output wave

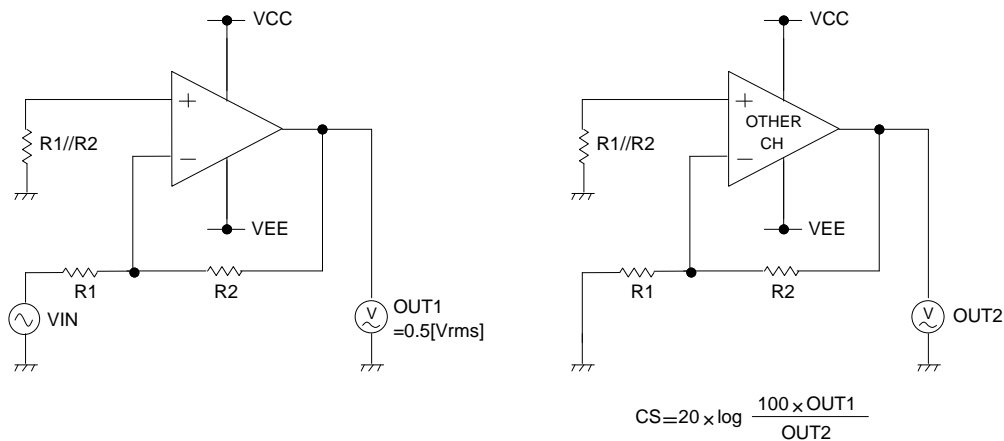

Figure 51. Test circuit 3(Channel Separation)

●Examples of circuit

○Voltage follower

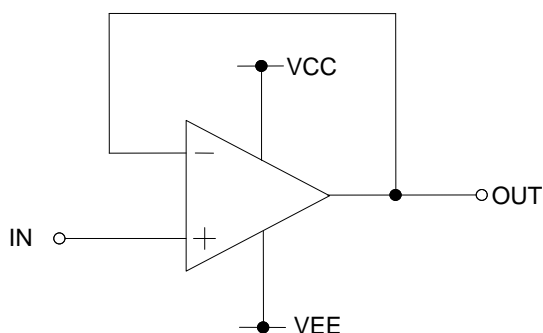

Figure 52. Voltage follower circuit

Voltage gain is 0dB.

Using this circuit, the output voltage (OUT) is configured to be equal to the input voltage (IN). This circuit also stabilizes the output voltage (OUT) due to high input impedance and low output impedance. Computation for output voltage (OUT) is shown below.

$$\text{OUT}=\text{IN}$$

○Inverting amplifier

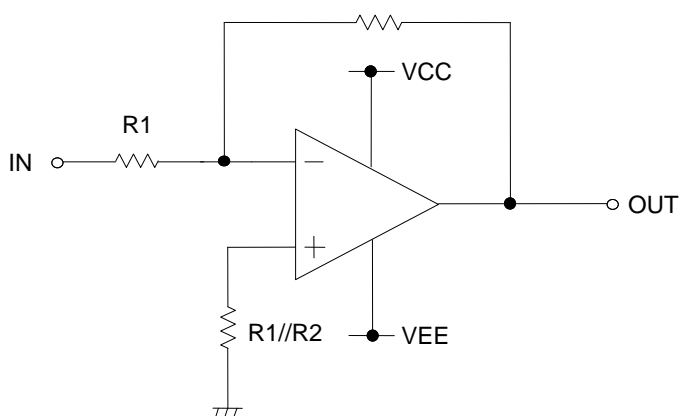

Figure 53. Inverting amplifier circuit

For inverting amplifier, input voltage (IN) is amplified by a voltage gain and depends on the ratio of R1 and R2. The out-of-phase output voltage is shown in the next expression

$$\text{OUT}=-\left(\frac{\text{R2}}{\text{R1}}\right) \cdot \text{IN}$$

This circuit has input impedance equal to R1.

○Non-inverting amplifier

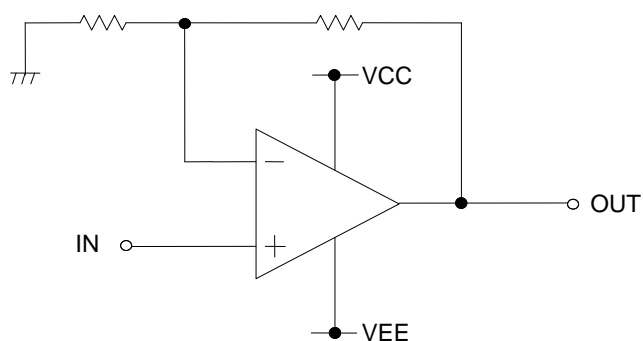

Figure 54. Non-inverting amplifier circuit

For non-inverting amplifier, input voltage (IN) is amplified by a voltage gain, which depends on the ratio of R1 and R2. The output voltage (OUT) is in-phase with the input voltage (IN) and is shown in the next expression.

$$\text{OUT}=\left(1 + \frac{\text{R2}}{\text{R1}}\right) \cdot \text{IN}$$

Effectively, this circuit has high input impedance since its input side is the same as that of the operational amplifier.

●Power Dissipation

Power dissipation (total loss) indicates the power that the IC can consume at Ta=25°C (normal temperature). As the IC consumes power, it heats up, causing its temperature to be higher than the ambient temperature. The allowable temperature that the IC can accept is limited. This depends on the circuit configuration, manufacturing process, and consumable power.

Power dissipation is determined by the allowable temperature within the IC (maximum junction temperature) and the thermal resistance of the package used (heat dissipation capability). Maximum junction temperature is typically equal to the maximum storage temperature. The heat generated through the consumption of power by the IC radiates from the mold resin or lead frame of the package. Thermal resistance, represented by the symbol θja°C/W, indicates this heat dissipation capability. Similarly, the temperature of an IC inside its package can be estimated by thermal resistance.

Figure 55(a) shows the model of the thermal resistance of the package. The equation below shows how to compute for the Thermal resistance (θja), given the ambient temperature (Ta), junction temperature (Tj), and power dissipation (Pd).

$$\theta_{ja} = (T_{jmax} - T_a) / P_d \quad ^\circ\text{C/W} \quad \dots \dots \dots (I)$$

The Derating curve in Figure 55(b) indicates the power that the IC can consume with reference to ambient temperature. Power consumption of the IC begins to attenuate at certain temperatures. This gradient is determined by Thermal resistance (θja), which depends on the chip size, power consumption, package, ambient temperature, package condition, wind velocity, etc. This may also vary even when the same of package is used. Thermal reduction curve indicates a reference value measured at a specified condition. Figure 56(c) and 56(d) shows an example of the derating curve for BA3472Y, BA3472W, BA3474Y and BA3474W.

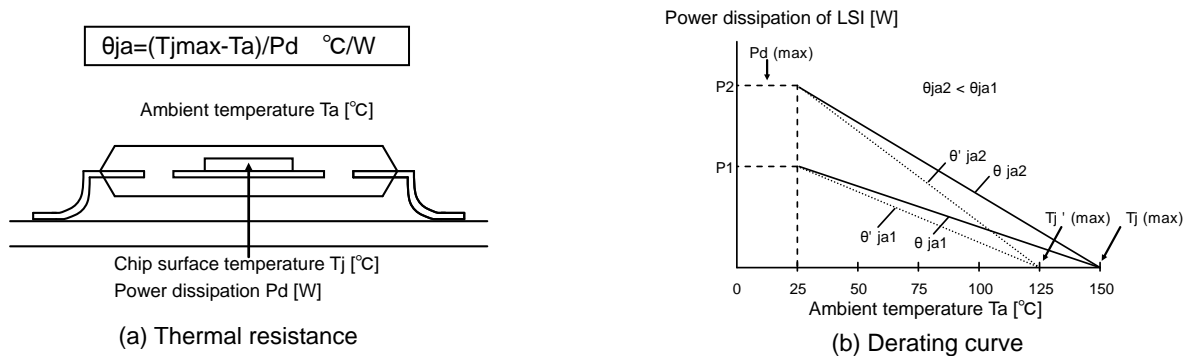
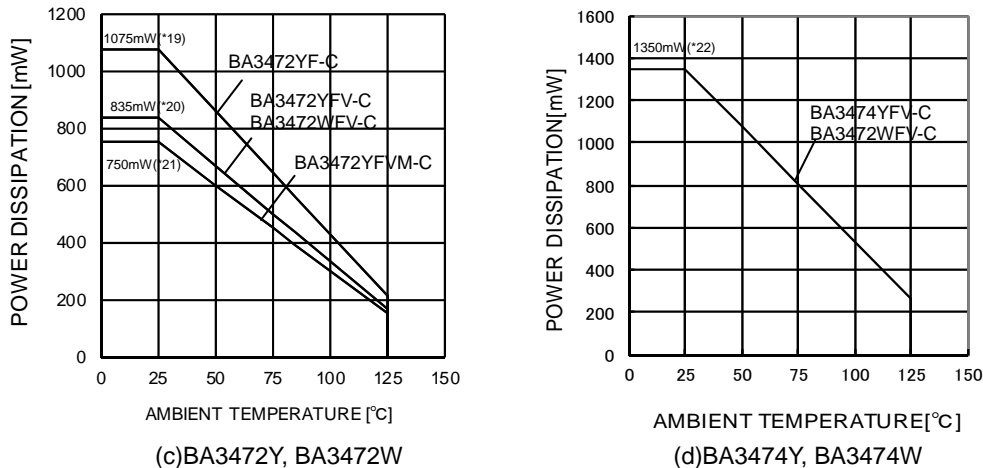

Figure 55. Thermal resistance and derating curve



(*19)	(*20)	(*21)	(*22)	Unit
8.6	6.7	6.0	10.8	mW/°C

When using the unit above Ta=25°C, subtract the value above per degree°C.
 Mounted on a FR4 glass epoxy 4 layers PCB 70mm × 70mm × 1.6mm (occupied copper area : 70mm × 70mm).

Figure 56. Derating curve

<Reference>

When the part is mounted on FR4 glass epoxy 4 layers PCB 70mm × 70mm × 1.6mm (occupied copper area : 70mm × 70mm).
 SSOP-B8 package : Pd at 125°C is 165mW so Vcc has to be below 27V.
 MSOP8 package : Pd at 125°C is 150mW so Vcc has to be below 25V.
 SSOP-B14 package : Pd at 125°C is 270mW so Vcc has to be below 22V.

●Operational Notes

- 1) Unused circuits
When there are unused op-amps, it is recommended that they are connected as in Figure 57, setting the non-inverting input terminal to a potential within the in-phase input voltage range (V_{icm}).
- 2) Input voltage
Applying VEE +36V to the input terminal is possible without causing deterioration of the electrical characteristics or destruction, regardless of the supply voltage. However, this does not ensure normal circuit operation. Please note that the circuit operates normally only when the input voltage is within the common mode input voltage range of the electric characteristics.
- 3) Power supply (single / dual)
The op-amp operates when the voltage supplied is between VCC and VEE. Therefore, the single supply op-amp can be used as dual supply op-amp as well.
- 4) Power dissipation Pd
Using the unit in excess of the rated power dissipation may cause deterioration in electrical characteristics including reduced current capability due to the rise of chip temperature. Therefore, please take into consideration the power dissipation (Pd) under actual operating conditions and apply a sufficient margin in thermal design. Refer to the thermal derating curves for more information.
- 5) Short-circuit between pins and erroneous mounting
Be careful when mounting the IC on printed circuit boards. The IC may be damaged if it is mounted in a wrong orientation or if pins are shorted together. Short circuit may be caused by conductive particles caught between the pins.
- 6) Operation in a strong electromagnetic field
Operating the IC in the presence of a strong electromagnetic field may cause the IC to malfunction.
- 7) Radiation
This IC is not designed to withstand radiation.
- 8) IC handling
Applying mechanical stress to the IC by deflecting or bending the board may cause fluctuations of the electrical characteristics due to piezo resistance effects.
- 9) Board inspection
Connecting a capacitor to a pin with low impedance may stress the IC. Therefore, discharging the capacitor after every process is recommended. In addition, when attaching and detaching the jig during the inspection phase, make sure that the power is turned OFF before inspection and removal. Furthermore, please take measures against ESD in the assembly process as well as during transportation and storage.
- 10) Output capacitor
If a large capacitor is connected between the output pin and GND pin, current from the charged capacitor will flow into the output pin and may destroy the IC when the VCC or VIN pin is shorted to ground or pulled down to 0V. Use a capacitor smaller than 1uF between output and GND.
- 11) Oscillation by output capacitor
Please pay attention to the oscillation by output capacitor and in designing an application of negative feedback loop circuit with these ICs.

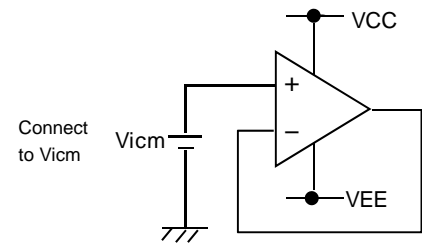

Figure 57. Example of application circuit for unused op-amp

Status of this document

The Japanese version of this document is formal specification. A customer may use this translation version only for a reference to help reading the formal version.

If there are any differences in translation version of this document formal version takes priority.

●Physical Dimensions Tape and Reel Information

SOP8

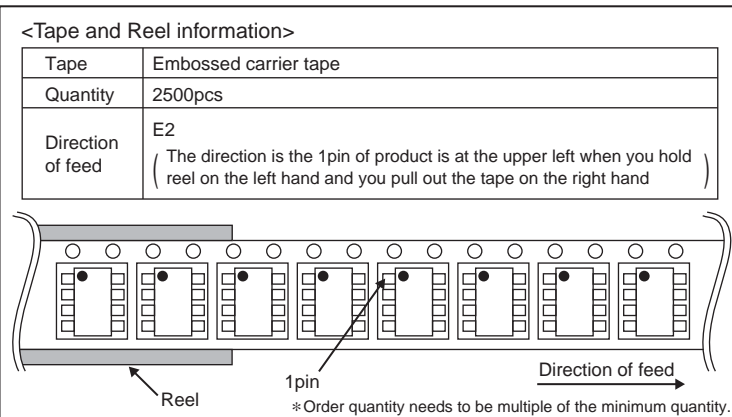
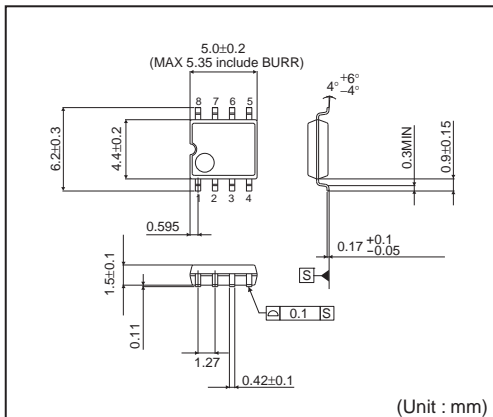

SSOP-B8

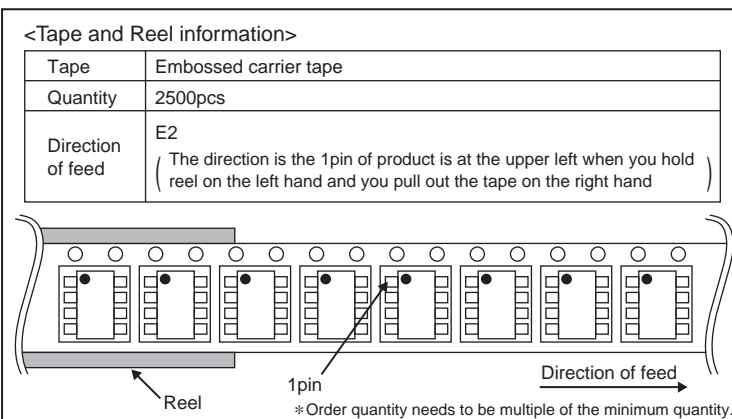
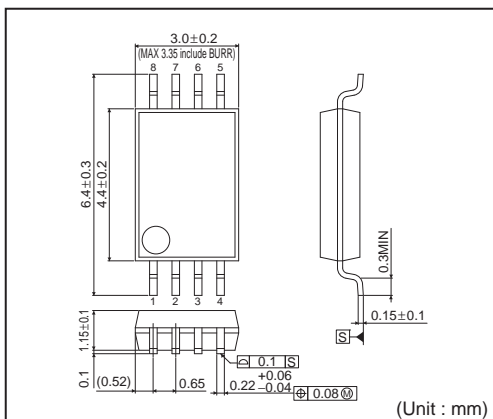

MSOP8

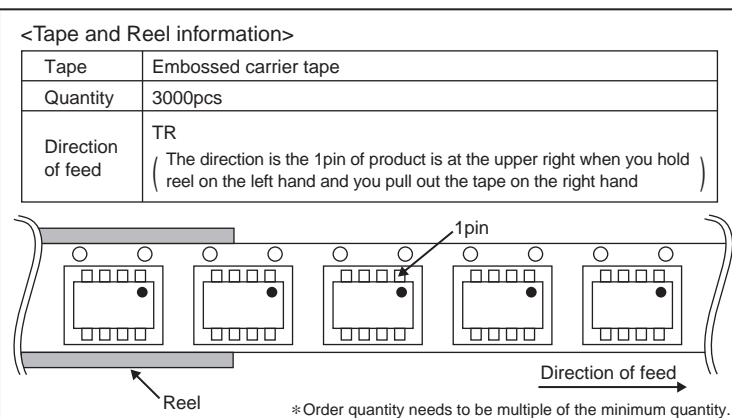
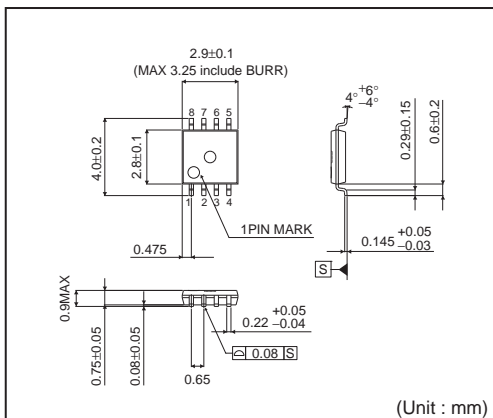

SSOP-B14

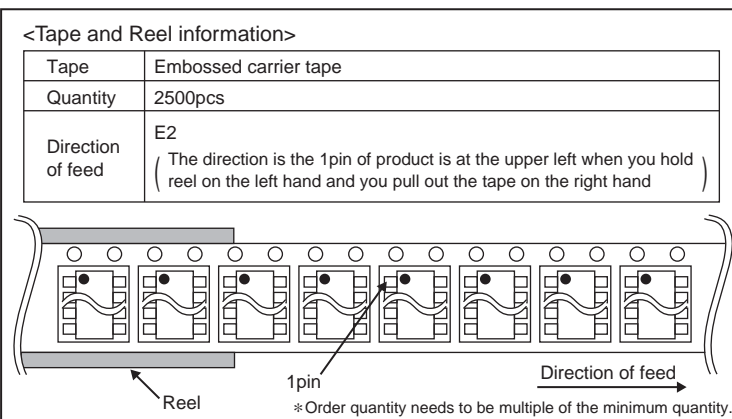
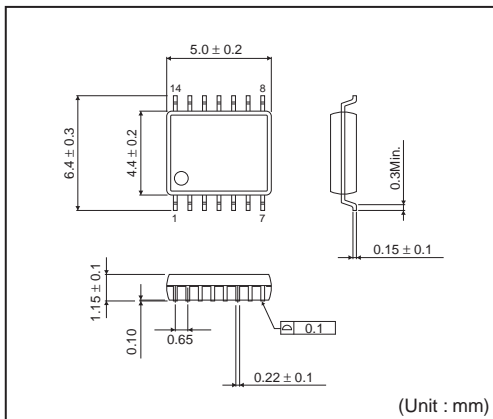

● Marking Diagrams

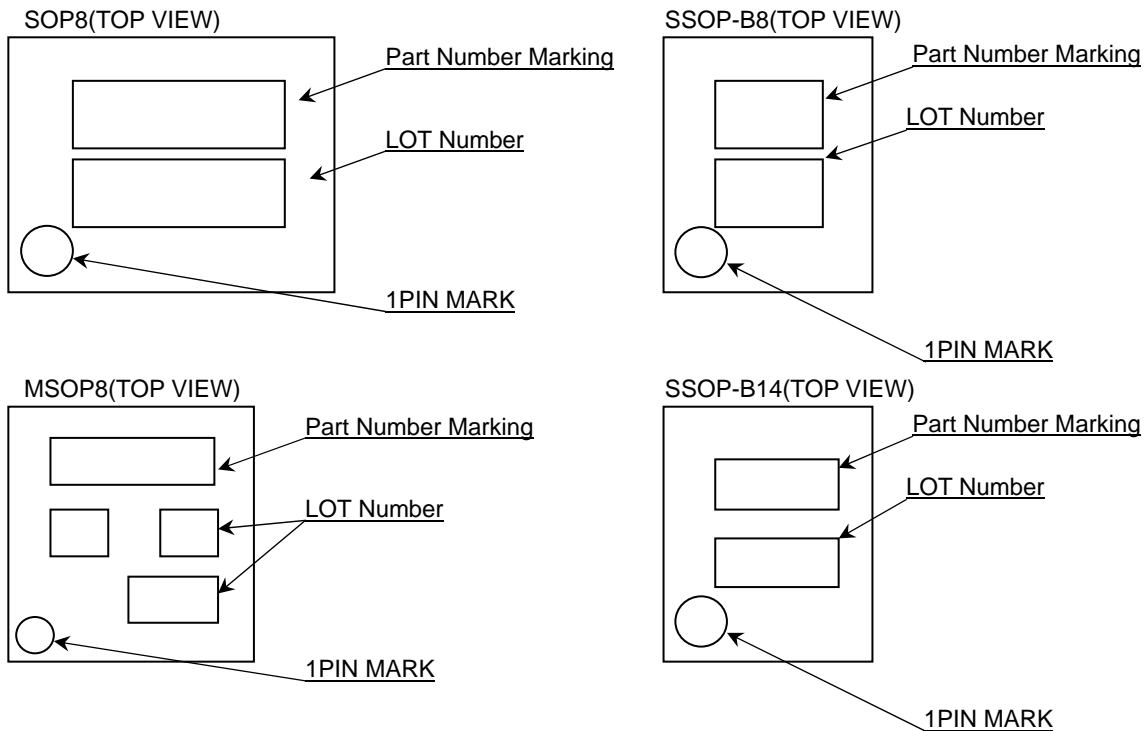

Product Name		Package Type	Marking
BA3472Y	F	SOP8	3472Y
	FV	SSOP-B8	72Y
	FVM	MSOP8	3472Y
BA3472W	FV	SSOP-B8	72W
BA3474Y		SSOP-B14	3474Y
BA3474W			3474W

● Land pattern data

All dimensions in mm

PKG	Land pitch e	Land space MIE	Land length $\geq \varnothing 2$	Land width b2
SOP8	1.27	4.60	1.10	0.76
SSOP-B8 SSOP-B14	0.65	4.60	1.20	0.35
MSOP8	0.65	2.62	0.99	0.35

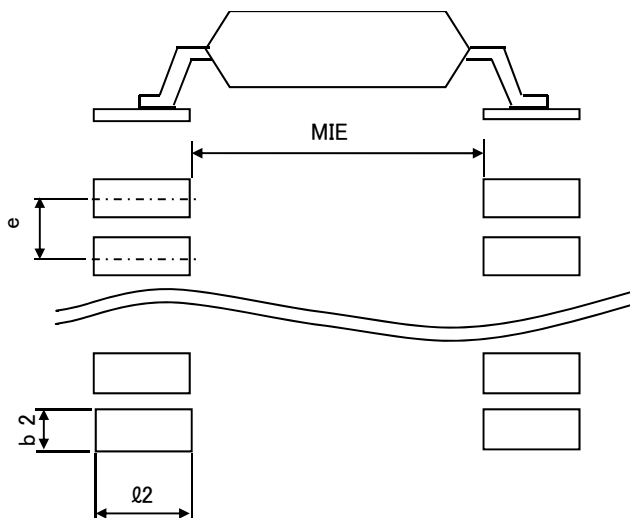

●Revision History

Date	Revision	Changes
24.Aug.2012	001	New Release
20.Dec.2012	002	BA3472Y, BA3474Y series and land pattern data inserted.

Notice

Precaution on using ROHM Products

1. If you intend to use our Products in devices requiring extremely high reliability (such as medical equipment ^(Note 1), aircraft/spacecraft, nuclear power controllers, etc.) and whose malfunction or failure may cause loss of human life, bodily injury or serious damage to property ("Specific Applications"), please consult with the ROHM sales representative in advance. Unless otherwise agreed in writing by ROHM in advance, ROHM shall not be in any way responsible or liable for any damages, expenses or losses incurred by you or third parties arising from the use of any ROHM's Products for Specific Applications.

(Note1) Medical Equipment Classification of the Specific Applications

JAPAN	USA	EU	CHINA
CLASS III	CLASS III	CLASS II b	CLASS III
CLASS IV		CLASS III	

2. ROHM designs and manufactures its Products subject to strict quality control system. However, semiconductor products can fail or malfunction at a certain rate. Please be sure to implement, at your own responsibilities, adequate safety measures including but not limited to fail-safe design against the physical injury, damage to any property, which a failure or malfunction of our Products may cause. The following are examples of safety measures:
 - [a] Installation of protection circuits or other protective devices to improve system safety
 - [b] Installation of redundant circuits to reduce the impact of single or multiple circuit failure
3. Our Products are not designed under any special or extraordinary environments or conditions, as exemplified below. Accordingly, ROHM shall not be in any way responsible or liable for any damages, expenses or losses arising from the use of any ROHM's Products under any special or extraordinary environments or conditions. If you intend to use our Products under any special or extraordinary environments or conditions (as exemplified below), your independent verification and confirmation of product performance, reliability, etc, prior to use, must be necessary:
 - [a] Use of our Products in any types of liquid, including water, oils, chemicals, and organic solvents
 - [b] Use of our Products outdoors or in places where the Products are exposed to direct sunlight or dust
 - [c] Use of our Products in places where the Products are exposed to sea wind or corrosive gases, including Cl₂, H₂S, NH₃, SO₂, and NO₂
 - [d] Use of our Products in places where the Products are exposed to static electricity or electromagnetic waves
 - [e] Use of our Products in proximity to heat-producing components, plastic cords, or other flammable items
 - [f] Sealing or coating our Products with resin or other coating materials
 - [g] Use of our Products without cleaning residue of flux (even if you use no-clean type fluxes, cleaning residue of flux is recommended); or Washing our Products by using water or water-soluble cleaning agents for cleaning residue after soldering
 - [h] Use of the Products in places subject to dew condensation
4. The Products are not subject to radiation-proof design.
5. Please verify and confirm characteristics of the final or mounted products in using the Products.
6. In particular, if a transient load (a large amount of load applied in a short period of time, such as pulse. is applied, confirmation of performance characteristics after on-board mounting is strongly recommended. Avoid applying power exceeding normal rated power; exceeding the power rating under steady-state loading condition may negatively affect product performance and reliability.
7. De-rate Power Dissipation (Pd) depending on Ambient temperature (Ta). When used in sealed area, confirm the actual ambient temperature.
8. Confirm that operation temperature is within the specified range described in the product specification.
9. ROHM shall not be in any way responsible or liable for failure induced under deviant condition from what is defined in this document.

Precaution for Mounting / Circuit board design

1. When a highly active halogenous (chlorine, bromine, etc.) flux is used, the residue of flux may negatively affect product performance and reliability.
2. In principle, the reflow soldering method must be used; if flow soldering method is preferred, please consult with the ROHM representative in advance.

For details, please refer to ROHM Mounting specification

Precautions Regarding Application Examples and External Circuits

1. If change is made to the constant of an external circuit, please allow a sufficient margin considering variations of the characteristics of the Products and external components, including transient characteristics, as well as static characteristics.
2. You agree that application notes, reference designs, and associated data and information contained in this document are presented only as guidance for Products use. Therefore, in case you use such information, you are solely responsible for it and you must exercise your own independent verification and judgment in the use of such information contained in this document. ROHM shall not be in any way responsible or liable for any damages, expenses or losses incurred by you or third parties arising from the use of such information.

Precaution for Electrostatic

This Product is electrostatic sensitive product, which may be damaged due to electrostatic discharge. Please take proper caution in your manufacturing process and storage so that voltage exceeding the Products maximum rating will not be applied to Products. Please take special care under dry condition (e.g. Grounding of human body / equipment / solder iron, isolation from charged objects, setting of Ionizer, friction prevention and temperature / humidity control).

Precaution for Storage / Transportation

1. Product performance and soldered connections may deteriorate if the Products are stored in the places where:
 - [a] the Products are exposed to sea winds or corrosive gases, including Cl₂, H₂S, NH₃, SO₂, and NO₂
 - [b] the temperature or humidity exceeds those recommended by ROHM
 - [c] the Products are exposed to direct sunshine or condensation
 - [d] the Products are exposed to high Electrostatic
2. Even under ROHM recommended storage condition, solderability of products out of recommended storage time period may be degraded. It is strongly recommended to confirm solderability before using Products of which storage time is exceeding the recommended storage time period.
3. Store / transport cartons in the correct direction, which is indicated on a carton with a symbol. Otherwise bent leads may occur due to excessive stress applied when dropping of a carton.
4. Use Products within the specified time after opening a humidity barrier bag. Baking is required before using Products of which storage time is exceeding the recommended storage time period.

Precaution for Product Label

QR code printed on ROHM Products label is for ROHM's internal use only.

Precaution for Disposition

When disposing Products please dispose them properly using an authorized industry waste company.

Precaution for Foreign Exchange and Foreign Trade act

Since our Products might fall under controlled goods prescribed by the applicable foreign exchange and foreign trade act, please consult with ROHM representative in case of export.

Precaution Regarding Intellectual Property Rights

1. All information and data including but not limited to application example contained in this document is for reference only. ROHM does not warrant that foregoing information or data will not infringe any intellectual property rights or any other rights of any third party regarding such information or data. ROHM shall not be in any way responsible or liable for infringement of any intellectual property rights or other damages arising from use of such information or data.:
2. No license, expressly or implied, is granted hereby under any intellectual property rights or other rights of ROHM or any third parties with respect to the information contained in this document.

Other Precaution

1. This document may not be reprinted or reproduced, in whole or in part, without prior written consent of ROHM.
2. The Products may not be disassembled, converted, modified, reproduced or otherwise changed without prior written consent of ROHM.
3. In no event shall you use in any way whatsoever the Products and the related technical information contained in the Products or this document for any military purposes, including but not limited to, the development of mass-destruction weapons.
4. The proper names of companies or products described in this document are trademarks or registered trademarks of ROHM, its affiliated companies or third parties.

General Precaution

1. Before you use our Products, you are requested to carefully read this document and fully understand its contents. ROHM shall not be in any way responsible or liable for failure, malfunction or accident arising from the use of any ROHM's Products against warning, caution or note contained in this document.
2. All information contained in this document is current as of the issuing date and subject to change without any prior notice. Before purchasing or using ROHM's Products, please confirm the latest information with a ROHM sales representative.
3. The information contained in this document is provided on an "as is" basis and ROHM does not warrant that all information contained in this document is accurate and/or error-free. ROHM shall not be in any way responsible or liable for any damages, expenses or losses incurred by you or third parties resulting from inaccuracy or errors of or concerning such information.

Looking for pricing, stock, or lifecycle information?

Click below to explore more details on WIN SOURCE:

-  [View BA3474YFV-CE2 on WIN SOURCE](#)
-  [Rohm Semiconductor](#) Information

Optimize Your Supply Chain with WIN SOURCE Solutions

-  Global Sourcing Solution
-  Obsolete Management
-  Cost Control Management
-  Shortage Management
-  Alternative Solution
-  Excess Inventory Management