

# Power Supply Selector Switch IC for SD Cards

## BD2204GUL

### General Description

BD2204GUL is high side switch IC that has built-in 2 circuits of MOSFET. Switch has achieved 120mΩ(Typ) on-resistance. 3.3V power supply and 1.8V power supply for memory card can be selected by SEL terminal. Moreover, it has built-in simultaneous-on prevention function at power switching, reverse-current protection function to prevent reverse-current from output terminal to input terminal at power-off, and discharge circuit to discharge electricity in output terminal.

### Features

- Dual channel of low on resistance (Typ = 120mΩ) N-channel MOSFET built in.
- 3.3V and 1.8V are chosen and an output is possible.
- 0.5A Continuous Current load.
- Reverse-current protection when power switch off.
- Prevent VIN1 and VIN2 from simultaneous-on.
- Output Discharge Circuit
- Thermal Shutdown
- Active-High Control Logic
- VCSP50L1 package

### Applications

- Digital cameras
- Digital video camera
- SD cards slot

### Key Specifications

- Input voltage range: VIN1=2.7 to 4.5V  
VIN2=1.2 to 2.4V
- ON resistance: 120mΩ(Typ)
- Operating current: 25μA(Typ)
- Standby current: 0.01μA(Typ)
- Operating temperature range: -40 to +85 °C

### Package

VCSP50L1

W(Typ) x D(Typ) x H(Max)

1.50mm x 1.00mm x 0.55mm

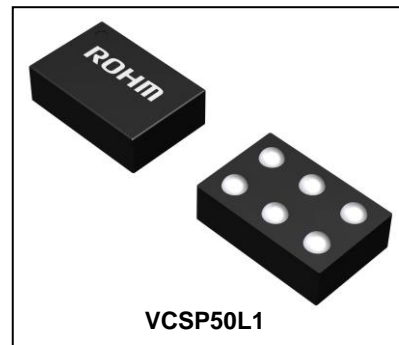

VCSP50L1

### Typical Application Circuit

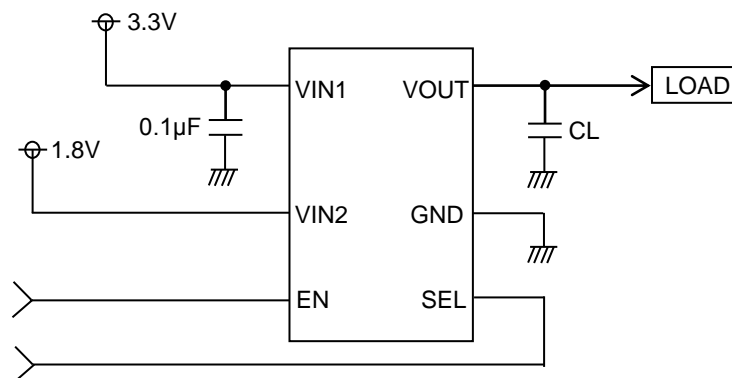

Figure 1. Typical application circuit

Block Diagram

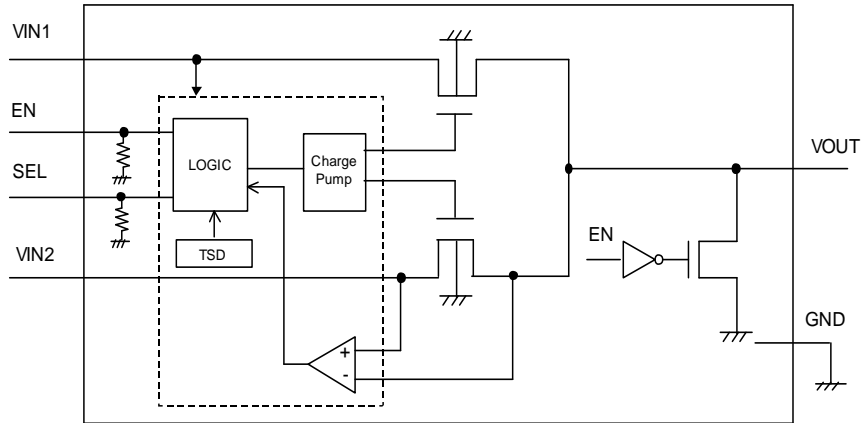

Figure 2. Block Diagram

Pin Configuration

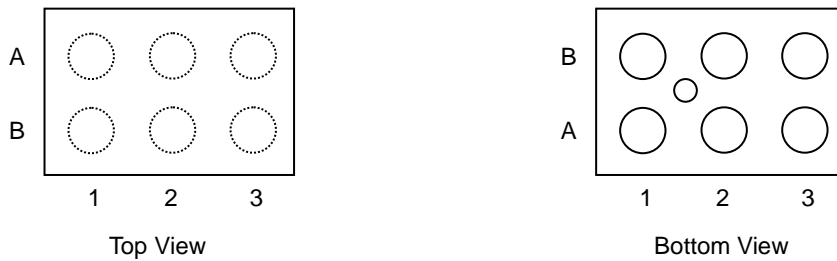

Figure 3. Pin Configuration

Pin Description

Pin No.	Symbol	I / O	Pin function
A1	VIN1	I	Switch1 input and supply voltage for IC
A2	VIN2	I	Switch2 input
A3	EN	I	Active-high enable input with pull-down resistance (Typ 700kΩ)
B1	VOUT	O	Switch output
B2	GND	-	Ground
B3	SEL	I	Output selector input with pull-down resistance (Typ 700kΩ) As SEL=L, VOUT=3.3V output, as SEL=H, VOUT=1.8V output

Absolute Maximum Ratings (Ta = 25°C)

Parameter	Symbol	Ratings	Unit
Switch1 input voltage	V <sub>IN1</sub>	-0.3 to 6.0	V
Switch2 input voltage	V <sub>IN2</sub>	-0.3 to 6.0	V
EN voltage	V <sub>EN</sub>	-0.3 to 6.0	V
SEL voltage	V <sub>SEL</sub>	-0.3 to 6.0	V
VOUT voltage	V <sub>OUT</sub>	-0.3 to 6.0	V
Output current	I <sub>OUT</sub>	1.0	A
Storage temperature	T <sub>STG</sub>	-55 to 150	°C
Power dissipation	P <sub>d</sub>	0.57 (Note 1)	W

(Note 1) In the case of exceeding Ta > 25°C, 4.6mW should be reduced per 1°C (Mount on 50mm x 58mm x 1.75mm Glass Epoxy Board)

Caution: Operating the IC over the absolute maximum ratings may damage the IC. The damage can either be a short circuit between pins or an open circuit between pins and the internal circuitry. Therefore, it is important to consider circuit protection measures, such as adding a fuse, in case the IC is operated over the absolute maximum ratings.

## Recommended Operating Conditions (Ta= -40°C to +85°C)

Parameter	Symbol	Ratings			Unit
		Min	Typ	Max	
Switch1 input voltage	V <sub>IN1</sub>	2.7	3.3	4.5	V
Switch2 input voltage	V <sub>IN2</sub>	1.2	1.8	2.4	V
Output current	I <sub>OUT</sub>	-	-	0.5	A

## Electrical Characteristics

(VIN1= 3.3V, VIN2= 1.8V, Ta= 25°C, unless otherwise specified.)

Parameter	Symbol	Limits			Unit	Condition
		Min	Typ	Max		
Operating current1	I <sub>DD1</sub>	-	30	45	μA	V <sub>EN</sub> = 1.2V, V <sub>SEL</sub> = 0V V <sub>OUT</sub> = OPEN
Operating current2	I <sub>DD2</sub>	-	35	52.5	μA	V <sub>EN</sub> = V <sub>SEL</sub> = 1.2V V <sub>OUT</sub> = OPEN
Standby current	I <sub>STB</sub>	-	0.01	1	μA	V <sub>EN</sub> = 0V, V <sub>OUT</sub> = OPEN
EN, SEL input voltage	V <sub>ENH</sub> V <sub>SELH</sub>	1.2	-	-	V	High input
	V <sub>ENL</sub> V <sub>SELL</sub>	-	-	0.4	V	Low input
EN, SEL input H current	I <sub>ENH</sub> I <sub>SELH</sub>	2.3	4.7	11.0	μA	V <sub>EN</sub> = V <sub>SEL</sub> = 3.3V with pull-down resistance
EN, SEL input L current	I <sub>ENL</sub> I <sub>SELL</sub>	-1.0	-	1.0	μA	V <sub>EN</sub> = V <sub>SEL</sub> = 0V
Pull-down resistance	R <sub>pd</sub>	300	700	1400	kΩ	EN and SEL PIN pull-down resistance
On-resistance1	R <sub>ON1</sub>	-	120	200 <sup>*2</sup>	mΩ	I <sub>OUT</sub> = 500mA
On-resistance2	R <sub>ON2</sub>	-	120	200 <sup>*2</sup>	mΩ	I <sub>OUT</sub> = 500mA
Switch leakage current	I <sub>LEAK</sub>	-	0.01	1	μA	V <sub>EN</sub> = 0V, V <sub>OUT</sub> = 0V
Output rise time1	T <sub>ON1</sub>	-	60	300	μs	SEL = L, RL = 10Ω V <sub>OUT</sub> : 10% → 90%
Output fall time1	T <sub>OFF1</sub>	-	0.1	1	μs	SEL = L, RL = 10Ω V <sub>OUT</sub> : 90% → 10%
Output fall time1DISC	T <sub>OFF1D</sub>	-	300	1000	μs	EN = SEL = L, CL = 1μF V <sub>OUT</sub> : 90% → 10%
Output rise time2	T <sub>ON2</sub>	-	30	150	μs	SEL = H, RL = 10Ω V <sub>OUT</sub> : 10% → 90%
Output fall time2	T <sub>OFF2</sub>	-	0.1	1	μs	SEL = H, RL = 10Ω V <sub>OUT</sub> : 90% → 10%
Output fall time2DISC	T <sub>OFF2D</sub>	-	220	1000	μs	EN = L, SEL = H, CL = 1μF V <sub>OUT</sub> : 90% → 10%
Discharge on-resistance	R <sub>DISC</sub>	-	80	150	Ω	I <sub>OUT</sub> = -1mA, V <sub>EN</sub> = 0V
Discharge current	I <sub>DISC</sub>	-	10	15	mA	V <sub>OUT</sub> = 3.3V, V <sub>EN</sub> = 0V
V <sub>OUT</sub> drop voltage <sup>*3</sup>	V <sub>outdrop1</sub>	-	-	0.4	V	CL = 15μF, I <sub>OUT</sub> = 500mA V <sub>OUT</sub> = VIN1 → VIN2
	V <sub>outdrop2</sub>	-	-	0.4	V	CL = 15μF, I <sub>OUT</sub> = 500mA V <sub>OUT</sub> = VIN2 → VIN1

<sup>\*2</sup> Not 100% tested at the time of shipment.

\*3 When the switch changes from VIN1 to VIN2 or from VIN2 to VIN1, it is possible that VOUT voltage drops. Dropped voltage of VOUT is specified as Voutdrop1 and Voutdrop2. That voltage drop is caused by the function which prevents VIN1 and VIN2 from turning on simultaneously. This function generates the period which both VIN1 and VIN2 are turned off, and prevents the penetration current between VIN1 and VIN2.

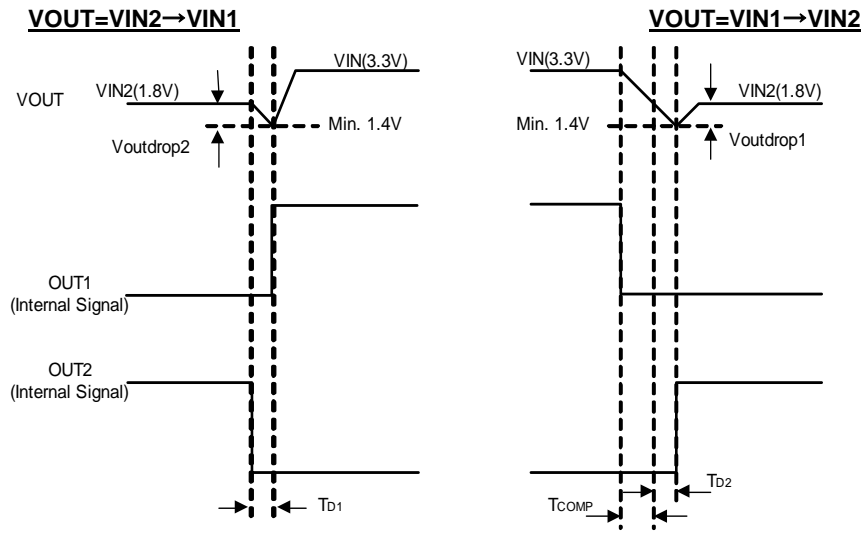

Figure 4. VOUT drop voltage

\*Td1 and Td2 + TCOMP are period of Simultaneous-Off.  
 \*TCOMP is period of VOUT becoming same voltage as VIN2.  
 \*The value of Min. is in condition of IOUT=500mA and CL=15uF.

Measurement Circuit

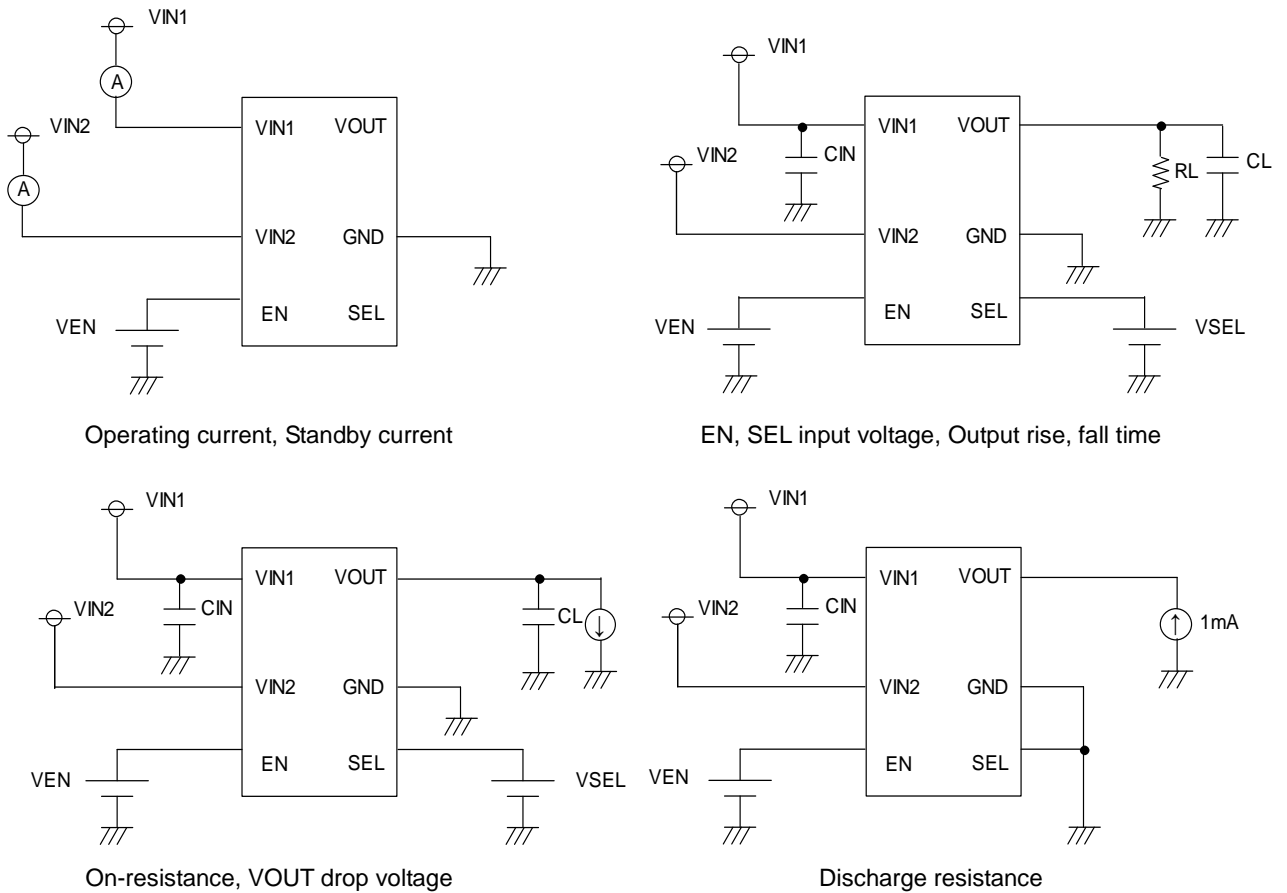

Figure 5. Measurement circuit

Typical Performance Curves

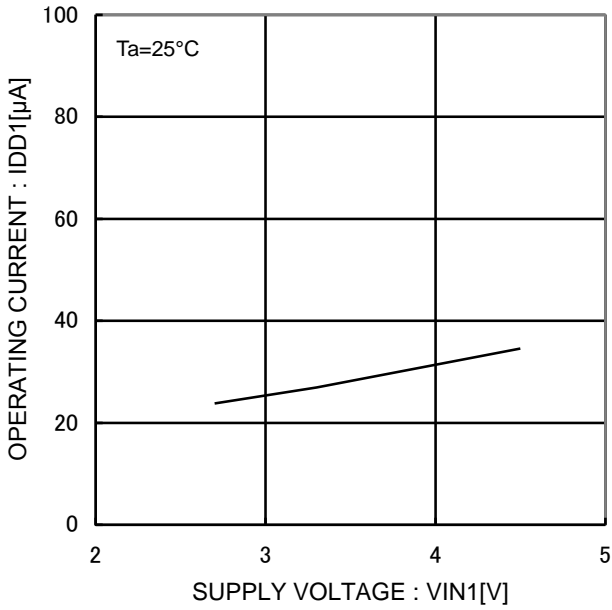

Figure 6. Operating current1  
EN Enable

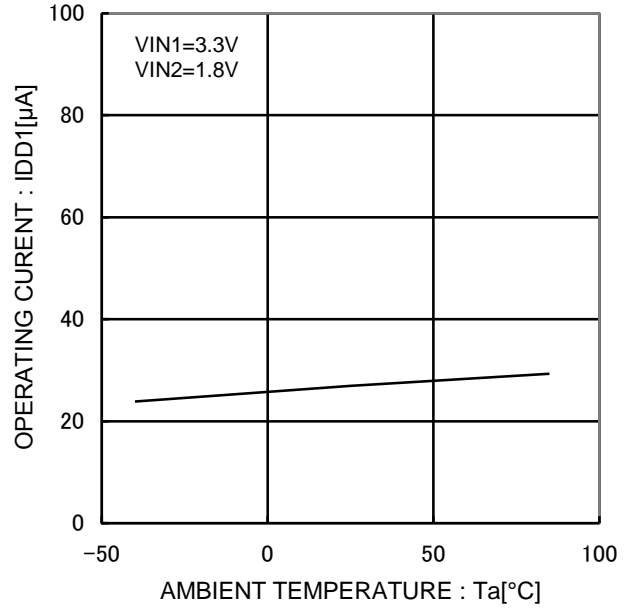

Figure 7. Operating current1  
EN Enable

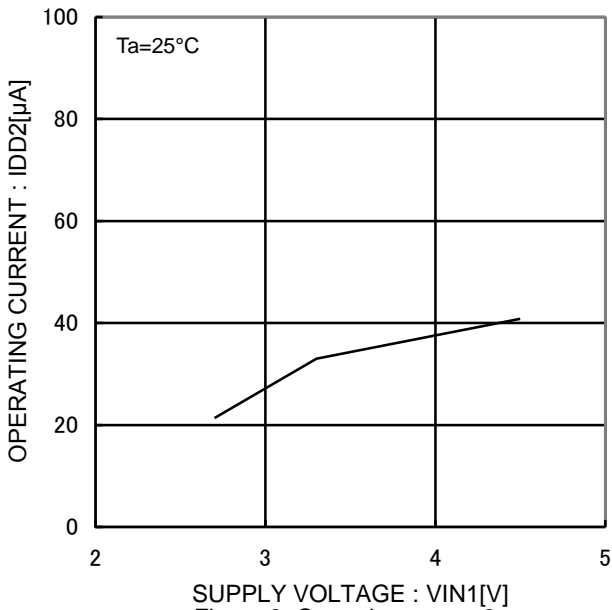

Figure 8. Operating current2  
EN Enable

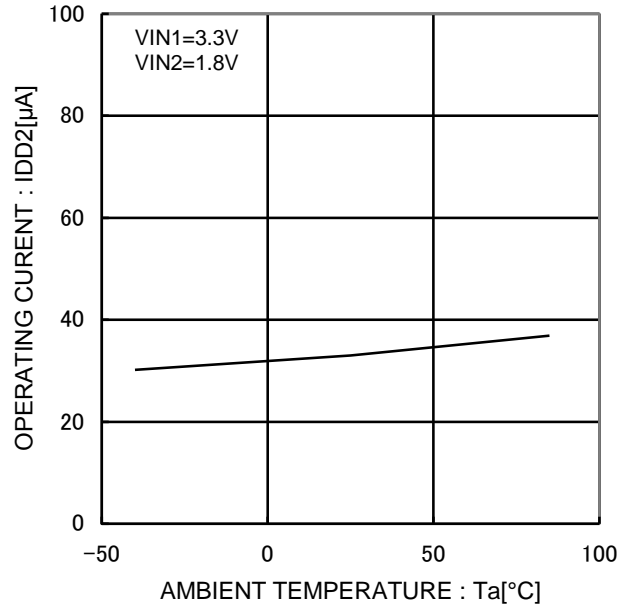
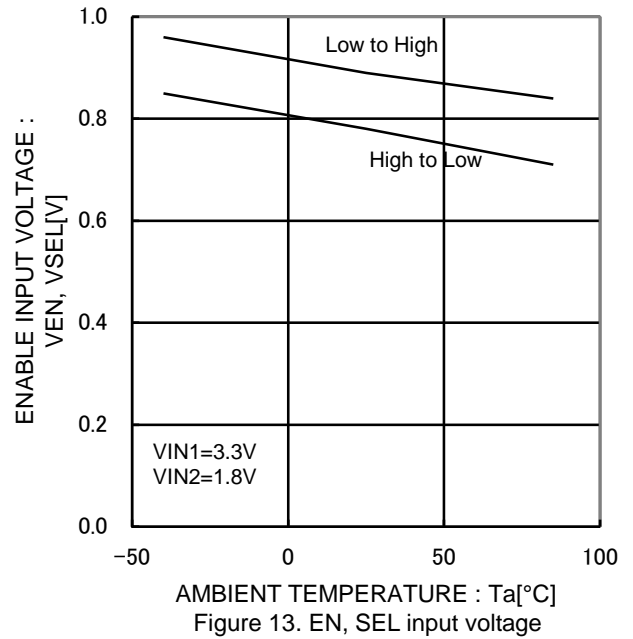
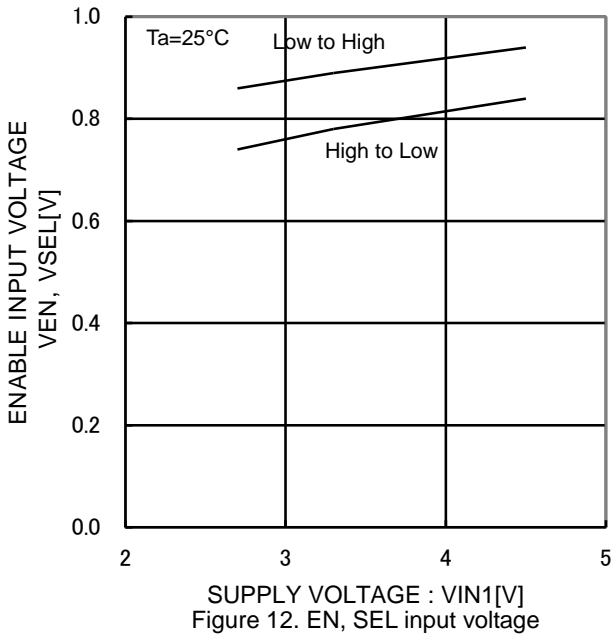
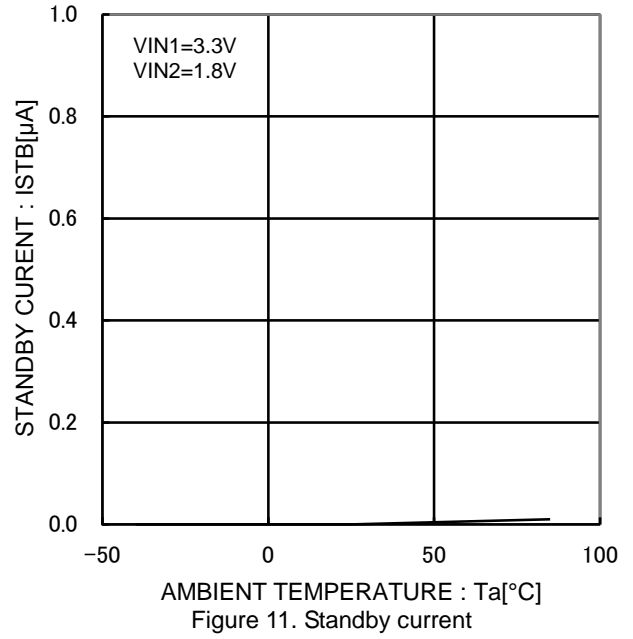
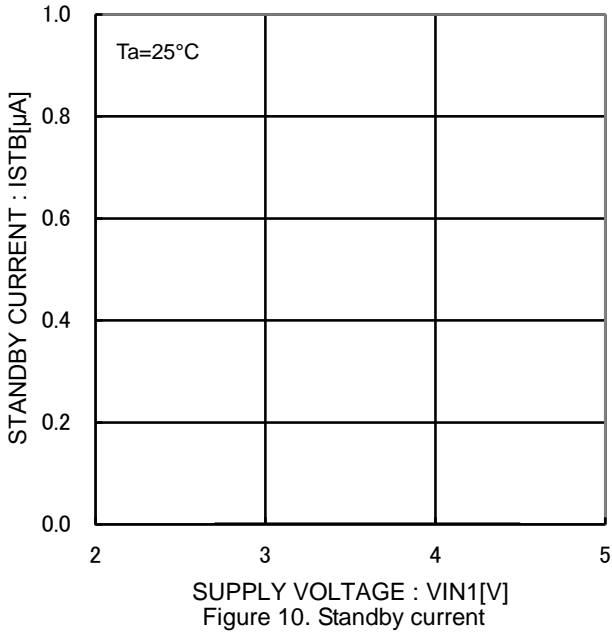
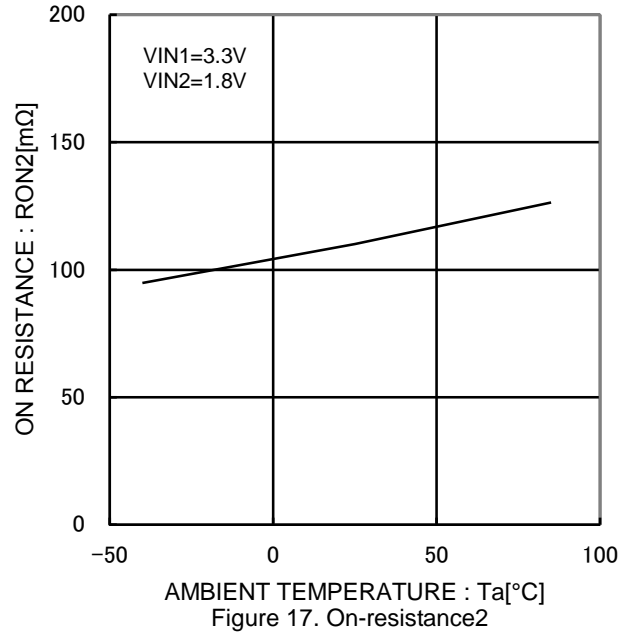
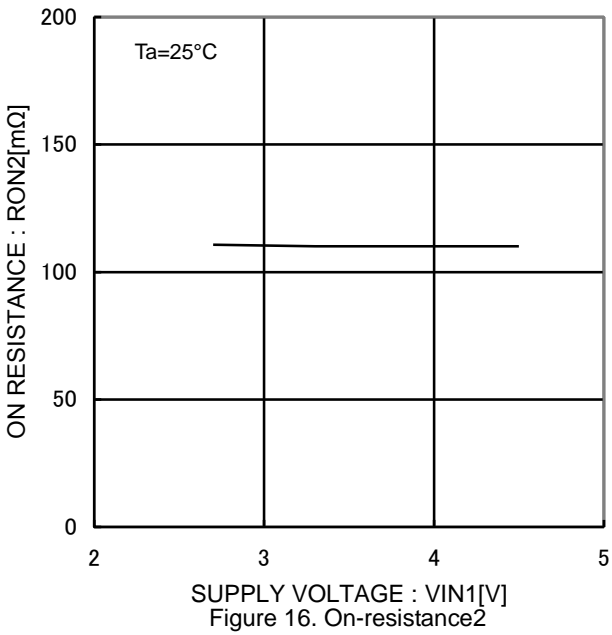
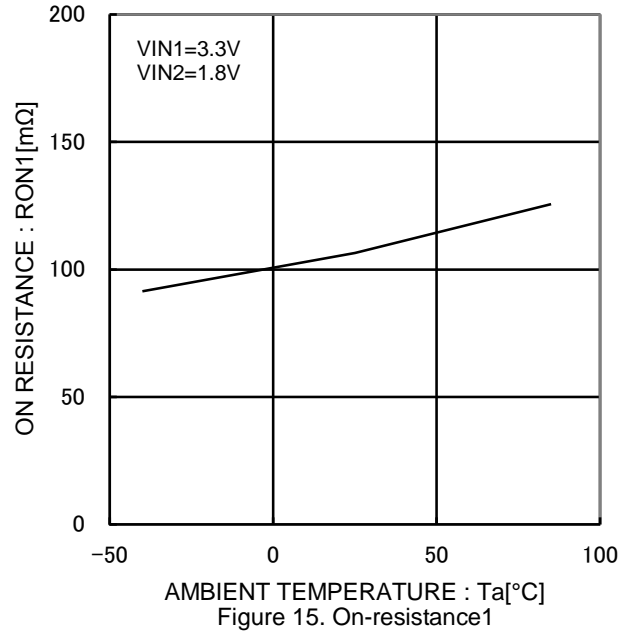
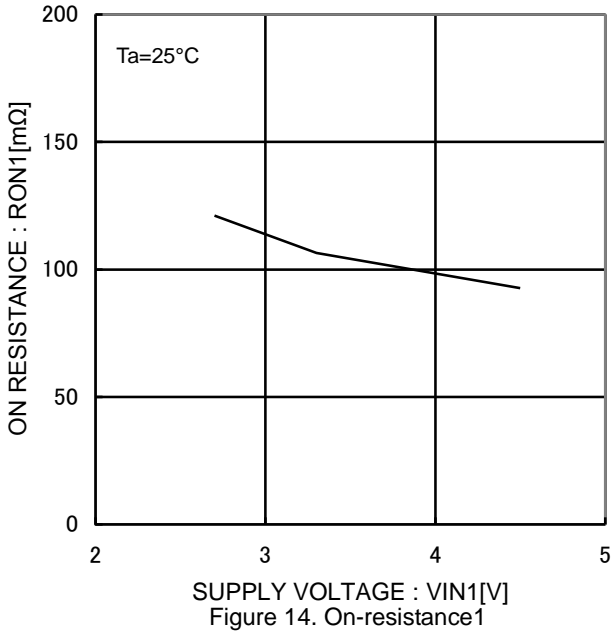

Figure 9. Operating current2  
EN Enable

Typical Performance Curves - continued



Typical Performance Curves - continued



Typical Performance Curves - continued

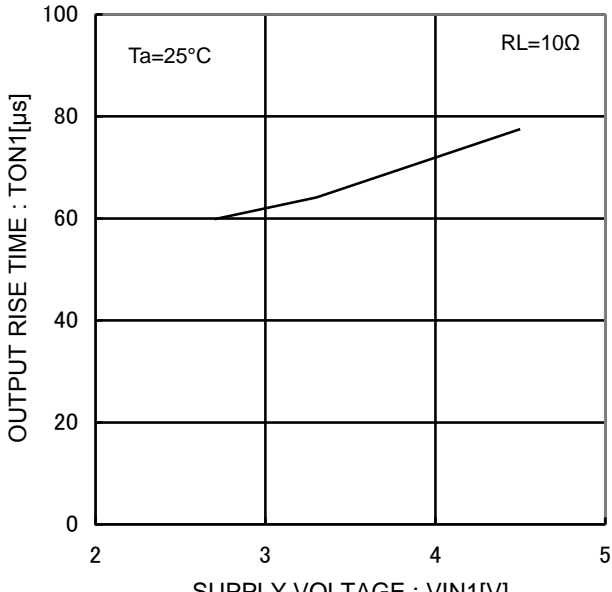

Figure 18. Output rise time1

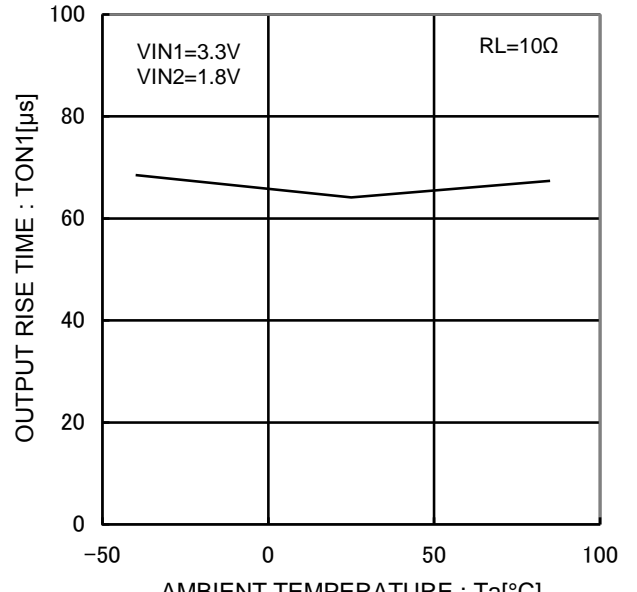

Figure 19. Output rise time1

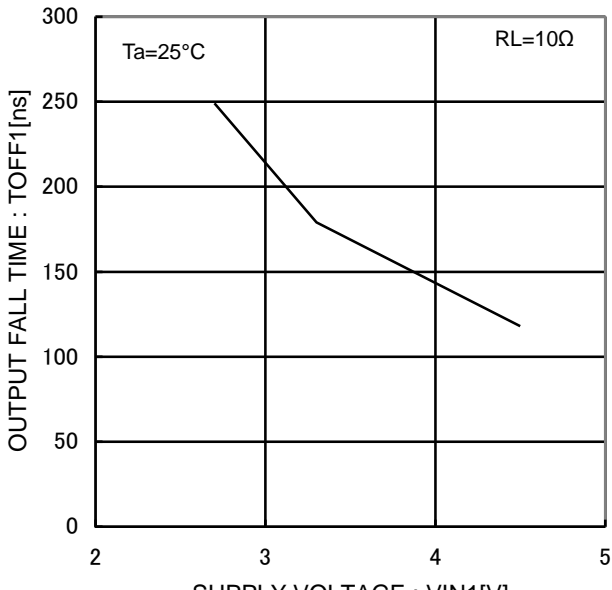

Figure 20. Output fall time1

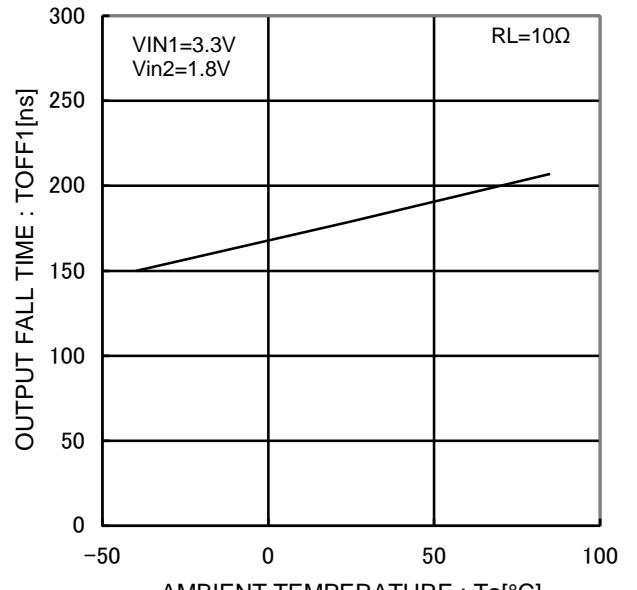
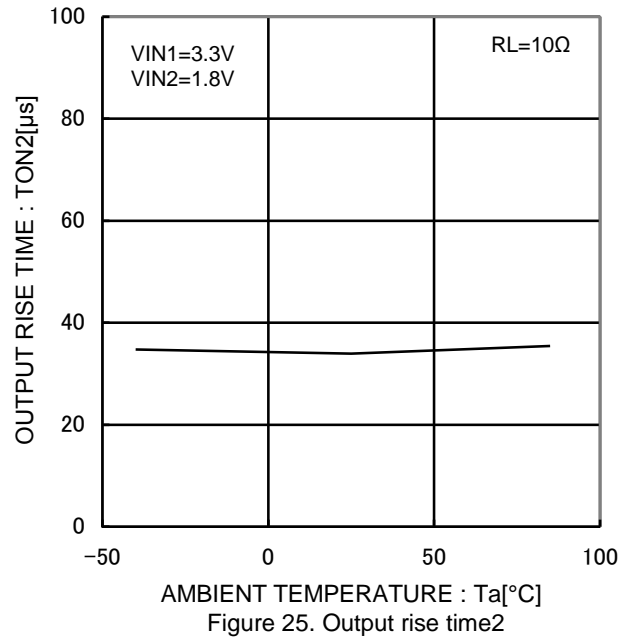
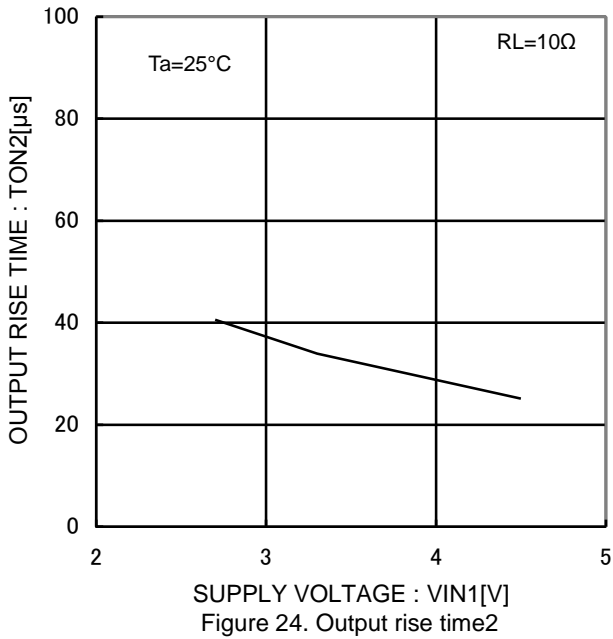
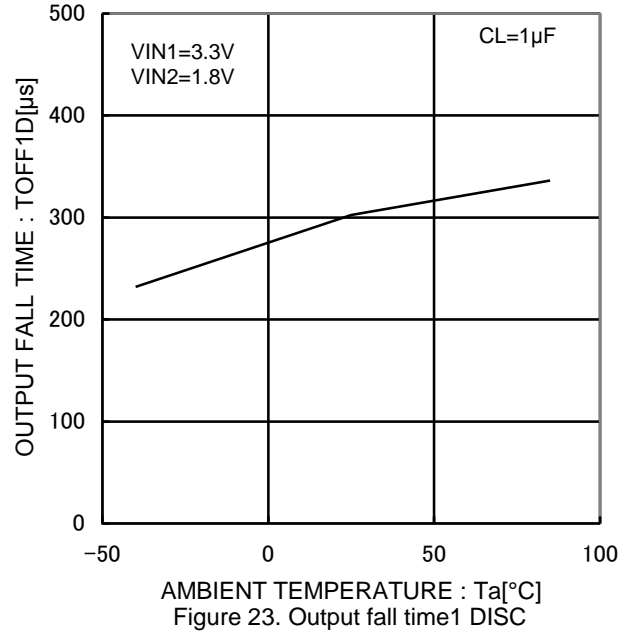
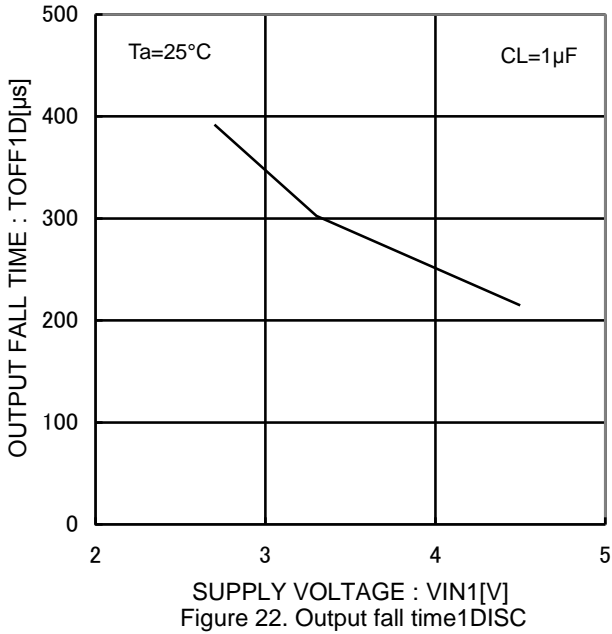
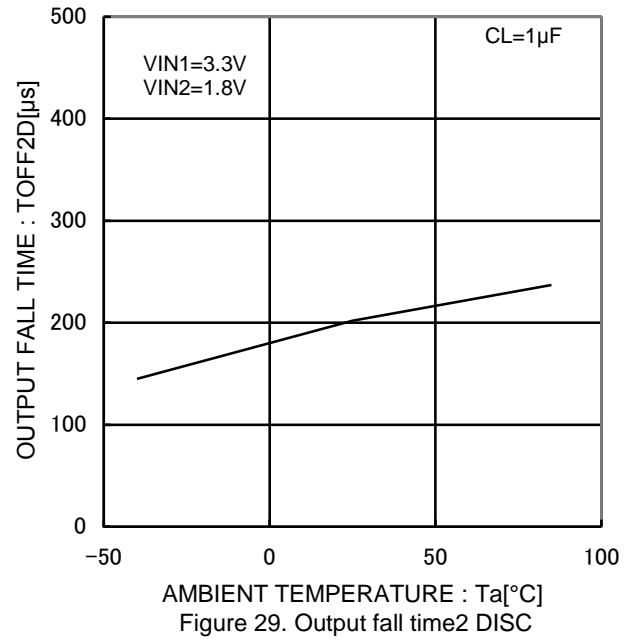
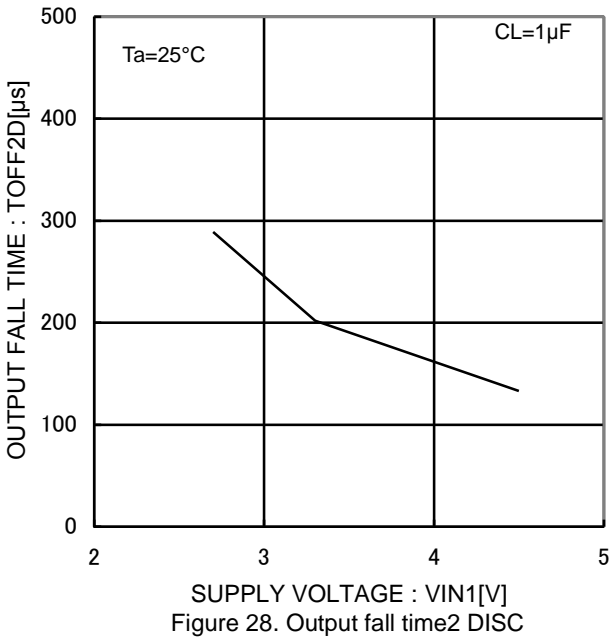
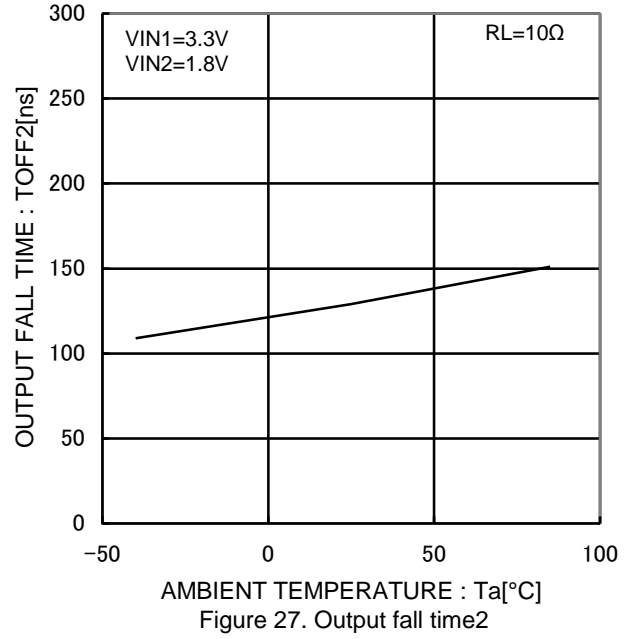
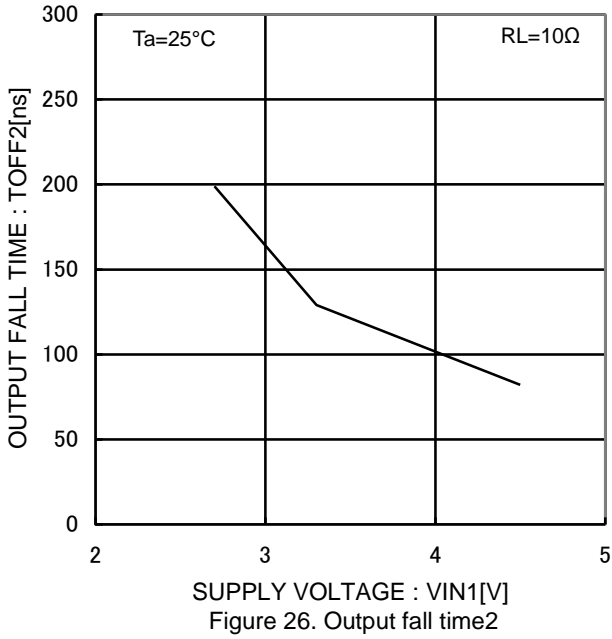

Figure 21. Output fall time1

Typical Performance Curves - continued



Typical Performance Curves - continued



Typical Performance Curves - continued

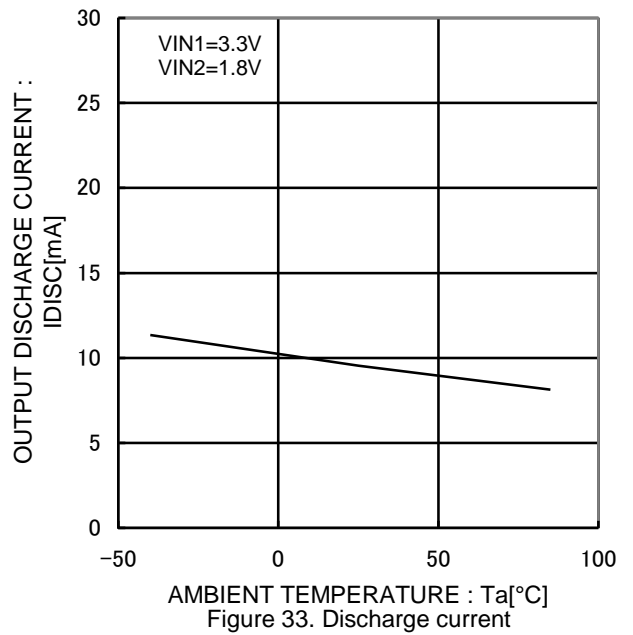
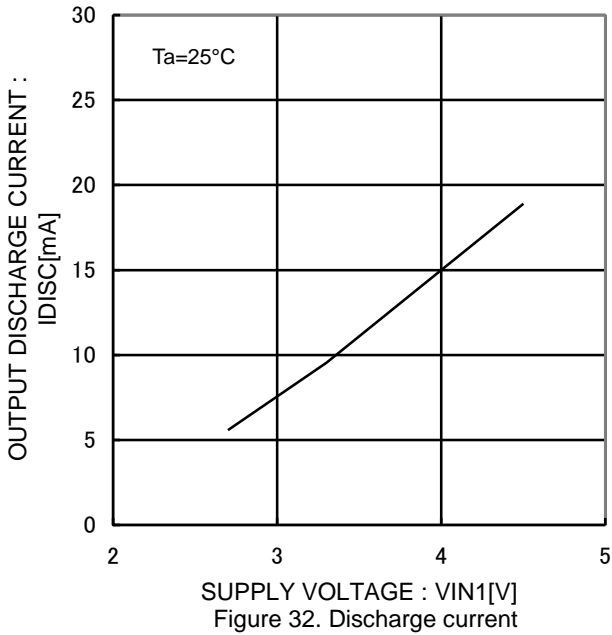
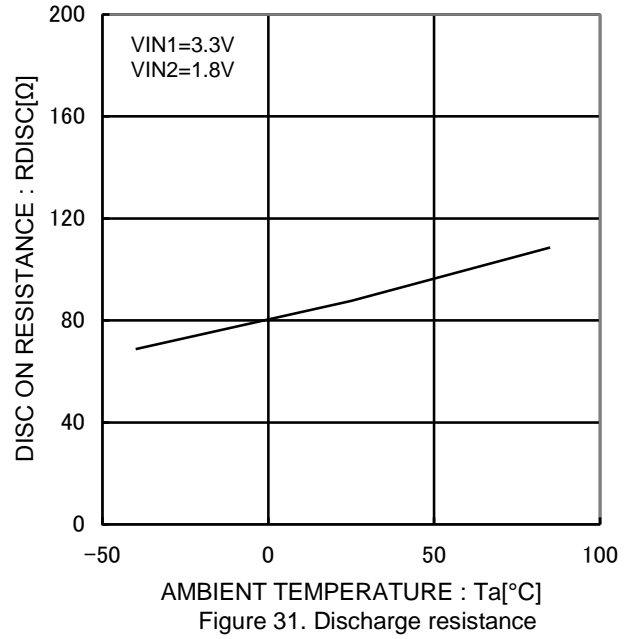
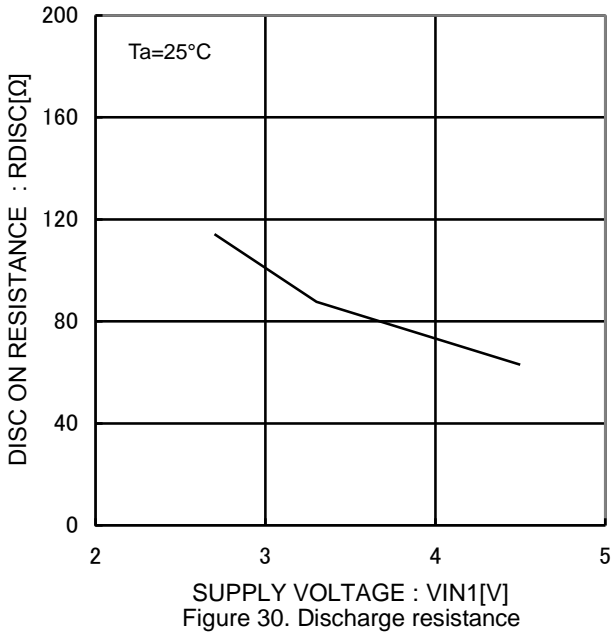

Typical Performance Curves - continued

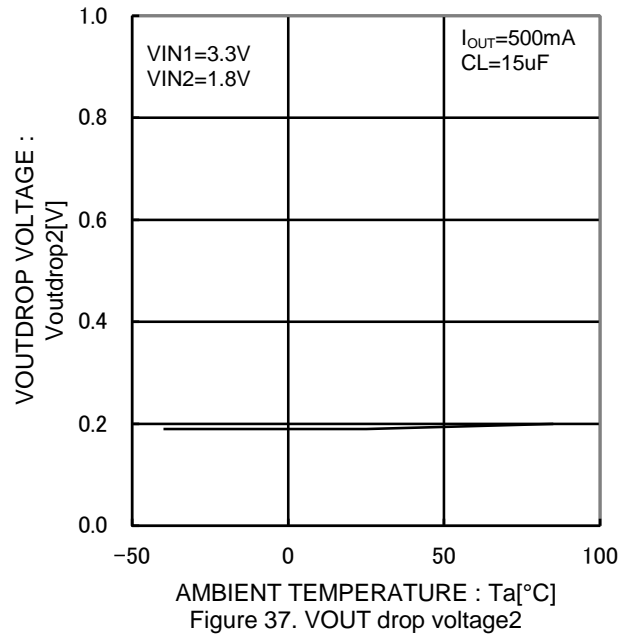
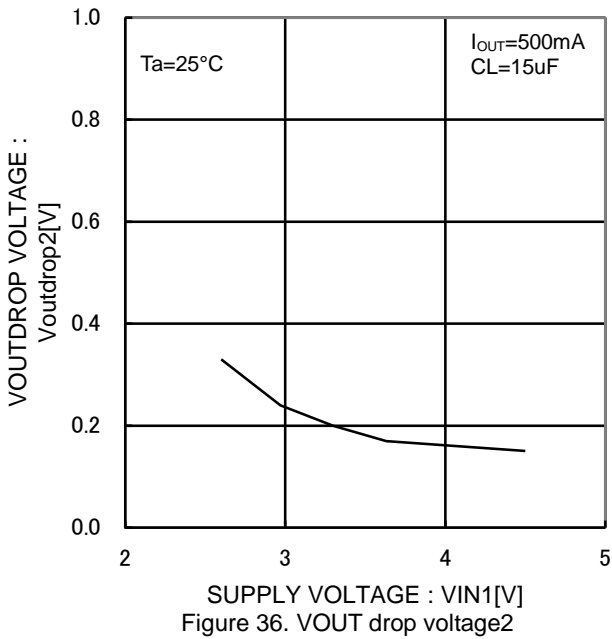
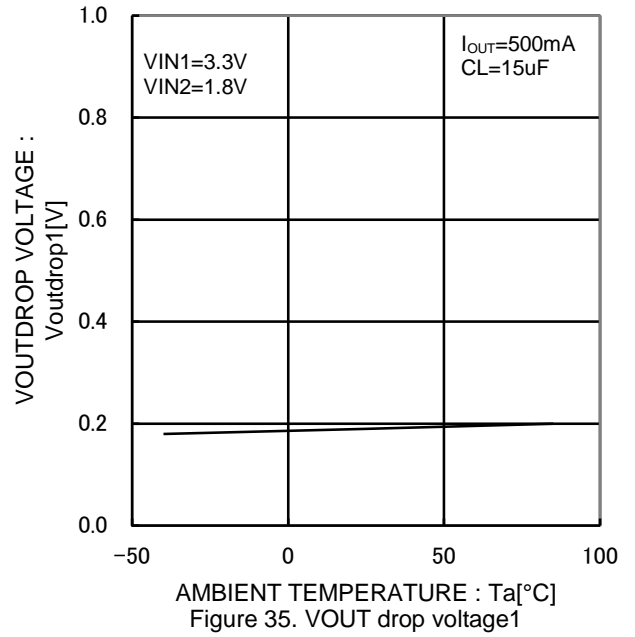
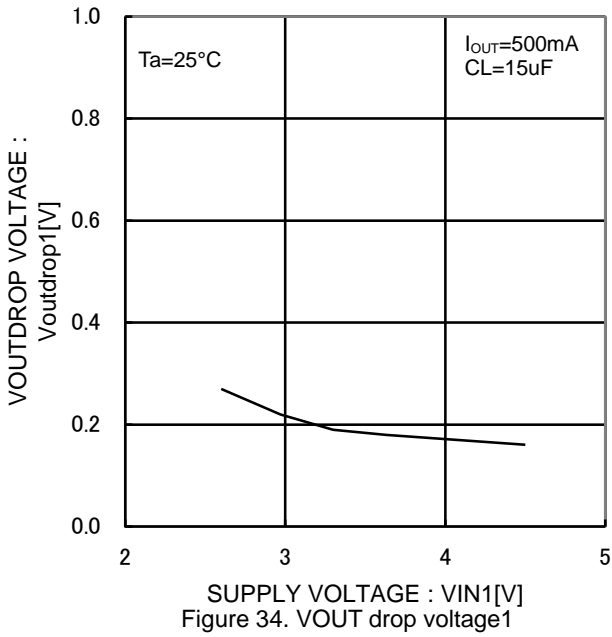

Typical Performance Curves - continued

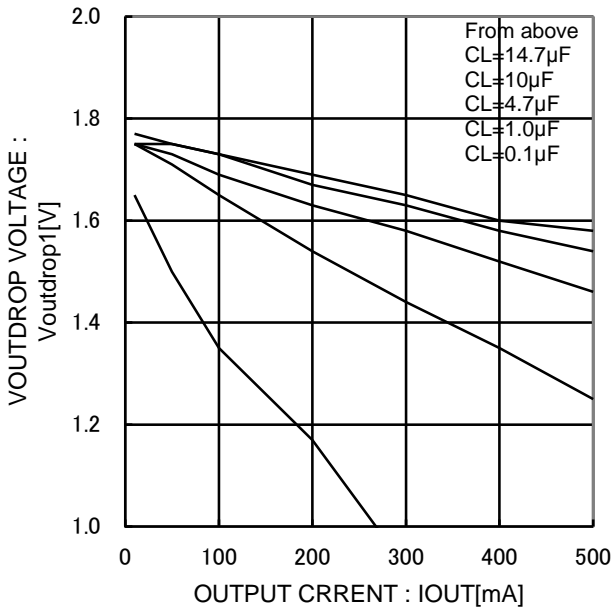

Figure 38. VOUT voltage drop  
Switch over from VIN1 to VIN2

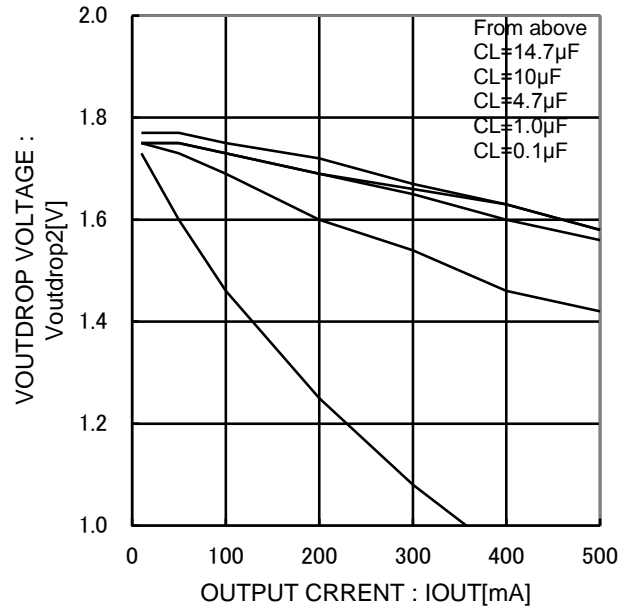

Figure 39. VOUT voltage drop  
Switch over from VIN2 to VIN1

Typical Wave Forms

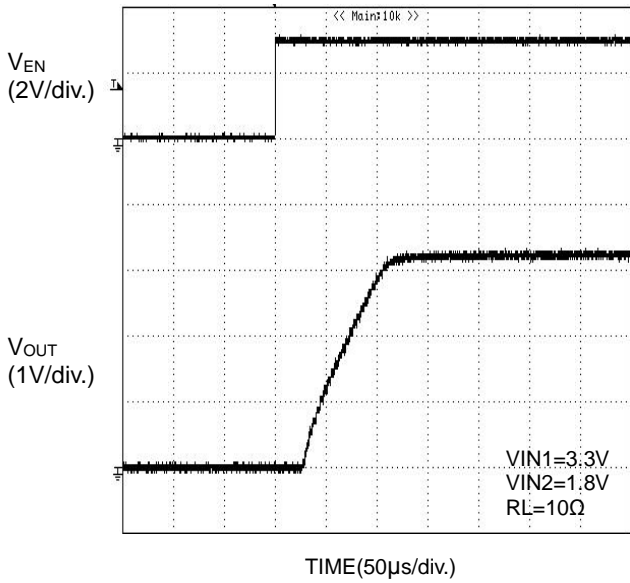

Figure 40. Output rise characteristic  
SEL=L

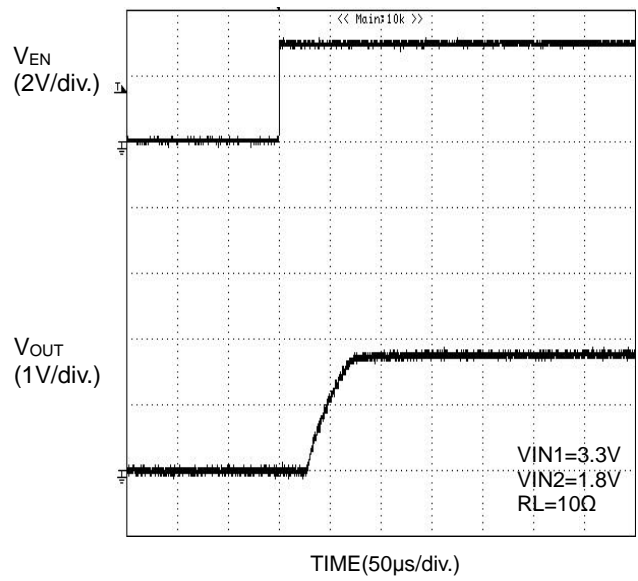

Figure 41. Output rise characteristic  
SEL=H

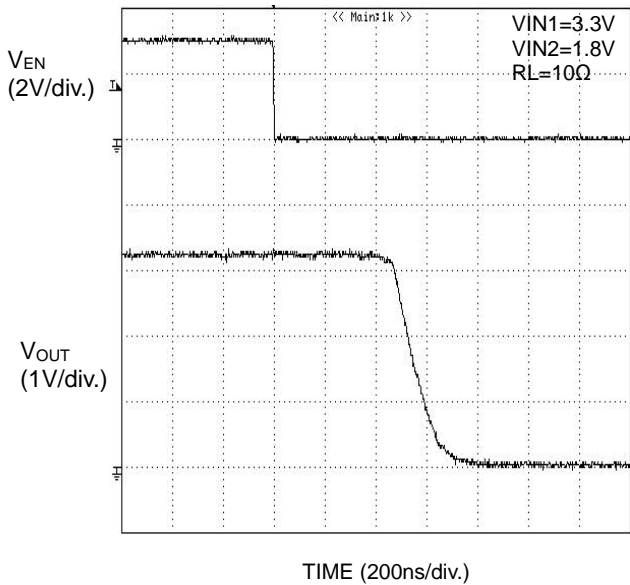

Figure 42. Output fall characteristic  
SEL=L

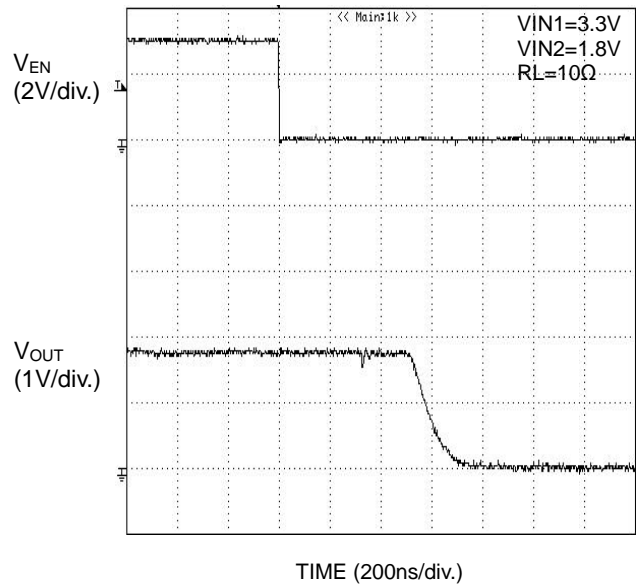

Figure 43. Output fall characteristic  
SEL=H

Typical Wave Forms - continued

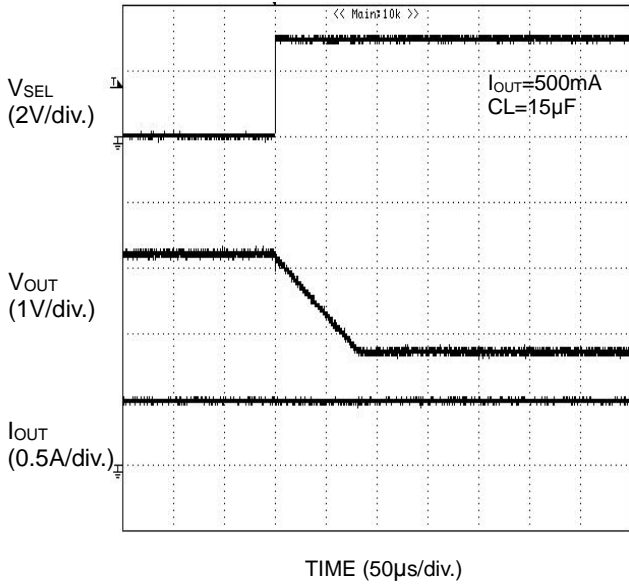

Figure 44. Power switch over characteristic from VIN1 to VIN2

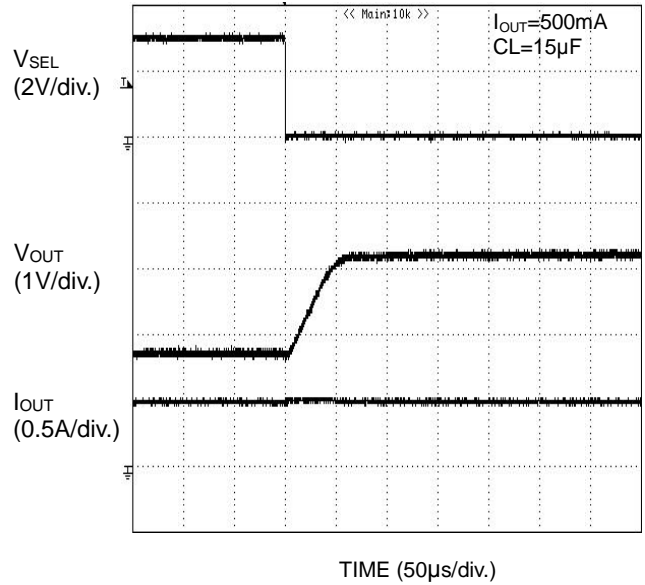

Figure 45. Power switch over characteristic from VIN2 to VIN1

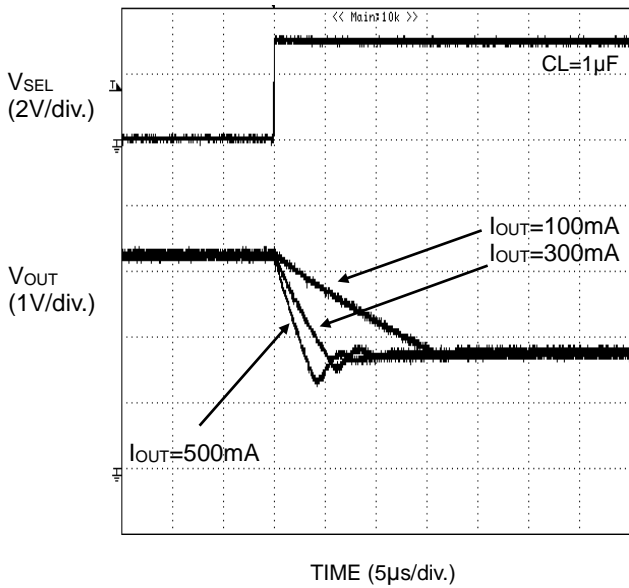

Figure 46. Power switch over characteristic from VIN1 to VIN2

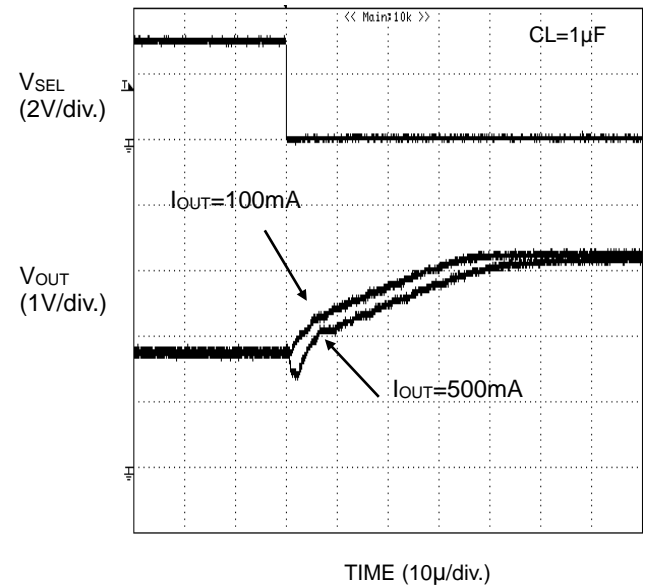

Figure 47. Power switch over characteristic from VIN2 to VIN1

## Application Example

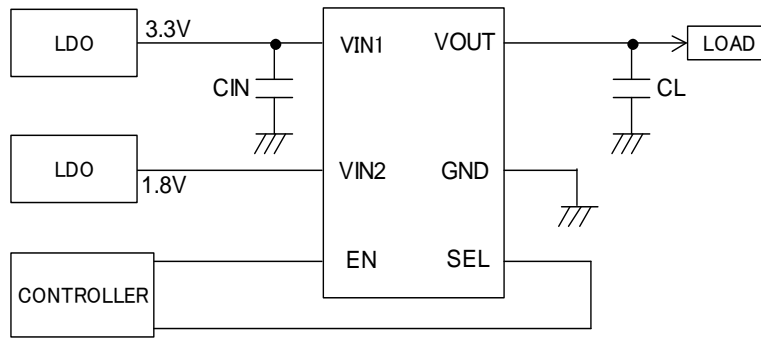

Figure 48. Application circuit example

## Application Information

When ringing occurs power source line to IC, and may cause bad influences upon IC actions. In order to avoid this case, connect a low ESR bypass capacitor which than  $0.1\mu\text{F}$ , nearby VIN1 terminal and GND terminal of IC.

When SEL pin worked, the load current ( $I_{\text{OUT}}$ ) and the load capacity (CL) of output give a change in VOUT drop voltage and change over time. Decide load capacity (CL) suited to load current ( $I_{\text{OUT}}$ ).

The external circuit constant and so on is changed and it uses, in which there are adequate margins by taking into account external parts or dispersion of IC including not only static characteristics but also transient characteristics.

## Functional Description

### 1. Switch operation

VIN1 terminal, VIN2 terminal and VOUT terminal are connected to the drain and the source of switch MOSFET respectively. And the VIN1 terminal is used also as power source input to internal control circuit.

When the switch is turned on from EN control input at SEL=L (SEL=H) input, VIN1 (VIN2) terminal and VOUT terminal are connected by a  $120\text{m}\Omega$  switch. In ON status, the switch is bi-directional. Therefore, when the potential of VOUT terminal is higher than that of VIN1 (VIN2) terminal, current flows from VOUT terminal to VIN1 (VIN2) terminal.

Since a parasitic diode between the drain and the source of switch MOSFET is canceled, in the OFF status, it is possible to prevent current from flowing reversely from VOUT to VIN1 (VIN2).

### 2. Change over operation

When H is input to SEL terminal while VIN1 voltage has been output to VOUT terminal, VIN2 voltage is output to VOUT terminal after detecting that VOUT terminal becomes lower than VIN2 voltage in order to prevent current from flowing reversely. In this case, the load current ( $I_{\text{OUT}}$ ) and the load capacity (CL) of output give a change in VOUT drop voltage and change over time. When L is input to SEL terminal while VIN2 voltage has been output to VOUT terminal, VIN1 voltage is output to VOUT terminal immediately.

### 3. Thermal shutdown circuit (TSD)

If over current would continue, the temperature of the IC would increase drastically. If the junction temperature were beyond  $135^\circ\text{C}$  (Typ), thermal shutdown circuit operates and makes power switch turn off. Then, when the junction temperature decreases lower than  $115^\circ\text{C}$  (Typ), power switch is turned on. Unless the fact of the increasing chips temperature is removed or the output of power switch is turned off, this operation repeats.

The thermal shutdown circuit operates when the switch is on (EN signal is active).

### 4. Discharge Circuit

Discharge circuit operates when switch off. When discharge circuit operates,  $80\Omega$  (Typ) resistor is connected between VOUT pin and GND pin. This discharges the electrical charge quickly.

Timing Chart

1) Stand-by → Switch1 ON → Stand-by

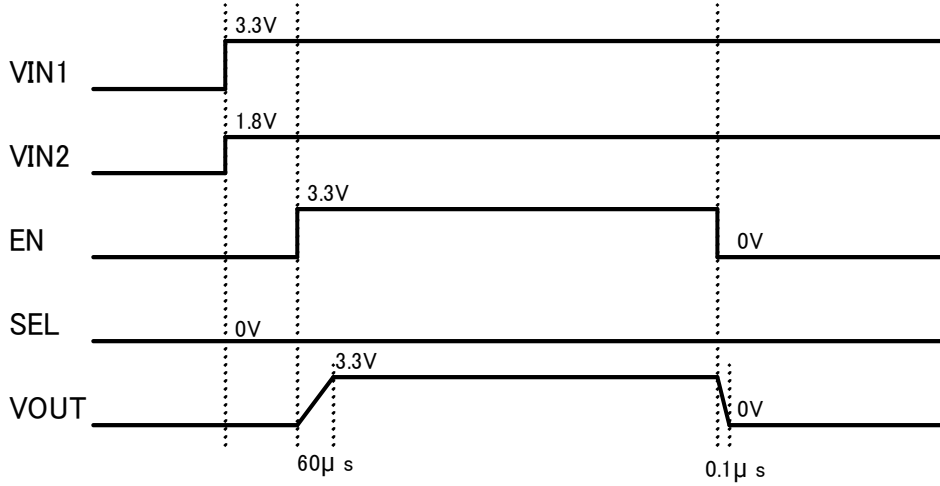

2) Stand-by → VIN1 Output (Switch1 ON) → VIN2 Output (Switch2 ON) → Stand-by

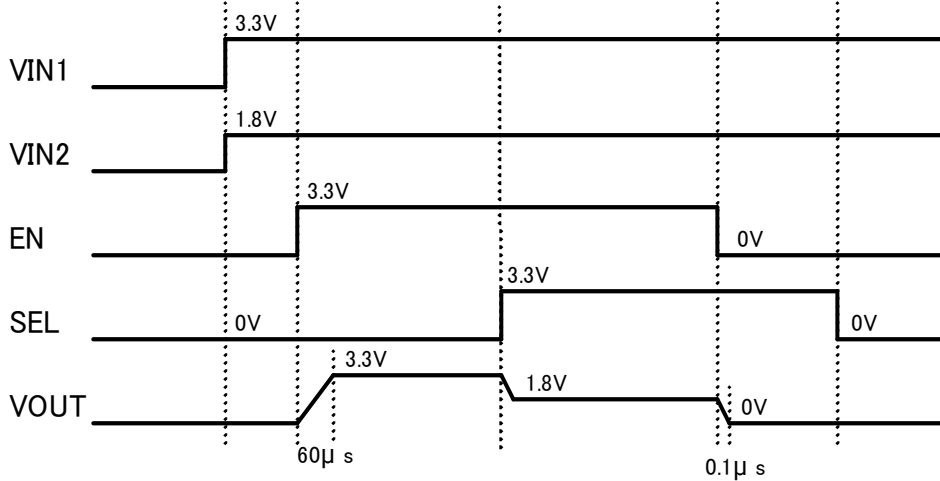

3) Stand-by → VIN2 Output (Switch2 ON) → VIN1 Output (Switch1 ON) → Stand-by

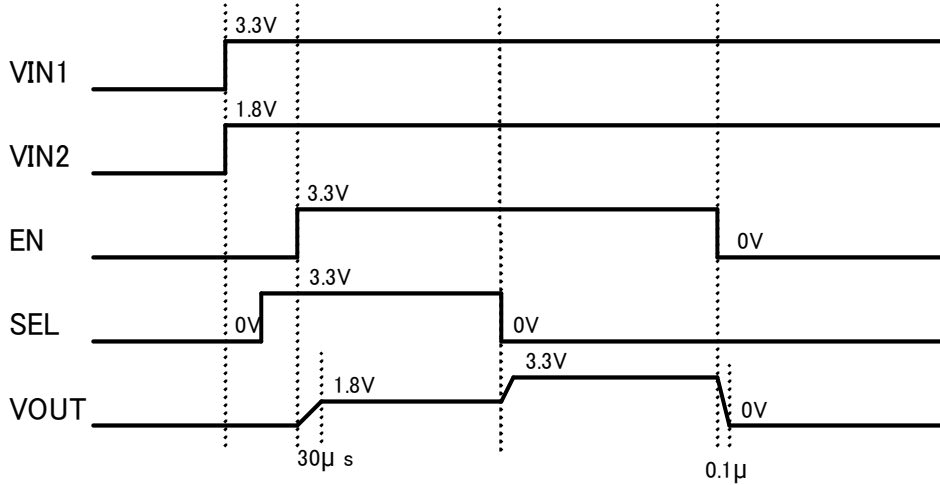
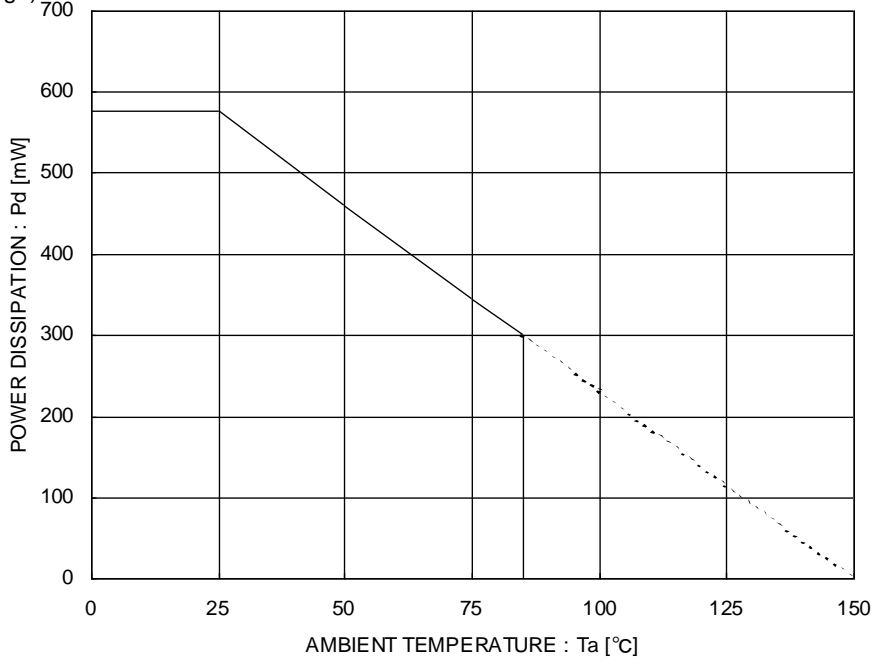

Figure 49. Timing Chart

**Power Dissipation**

(VCSP50L1 package)



\* 50mm x 58mm x 1.75mm Glass Epoxy Board

Figure 50. Power dissipation curve (Pd-Ta Curve)

**I/O Equivalence Circuit**

Symbol	Pin No	Equivalent circuit
VIN1	A1	
VIN2	A2	
EN, SEL	A3, B3	
VOUT	B1	

## Operational Notes

### 1. Reverse Connection of Power Supply

Connecting the power supply in reverse polarity can damage the IC. Take precautions against reverse polarity when connecting the power supply, such as mounting an external diode between the power supply and the IC's power supply pins.

### 2. Power Supply Lines

Design the PCB layout pattern to provide low impedance supply lines. Furthermore, connect a capacitor to ground at all power supply pins. Consider the effect of temperature and aging on the capacitance value when using electrolytic capacitors.

### 3. Ground Voltage

Ensure that no pins are at a voltage below that of the ground pin at any time, even during transient condition.

### 4. Ground Wiring Pattern

When using both small-signal and large-current ground traces, the two ground traces should be routed separately but connected to a single ground at the reference point of the application board to avoid fluctuations in the small-signal ground caused by large currents. Also ensure that the ground traces of external components do not cause variations on the ground voltage. The ground lines must be as short and thick as possible to reduce line impedance.

### 5. Thermal Consideration

Should by any chance the power dissipation rating be exceeded the rise in temperature of the chip may result in deterioration of the properties of the chip. In case of exceeding this absolute maximum rating, increase the board size and copper area to prevent exceeding the Pd rating.

### 6. Recommended Operating Conditions

These conditions represent a range within which the expected characteristics of the IC can be approximately obtained. The electrical characteristics are guaranteed under the conditions of each parameter.

### 7. Inrush Current

When power is first supplied to the IC, it is possible that the internal logic may be unstable and inrush current may flow instantaneously due to the internal powering sequence and delays, especially if the IC has more than one power supply. Therefore, give special consideration to power coupling capacitance, power wiring, width of ground wiring, and routing of connections.

### 8. Operation Under Strong Electromagnetic Field

Operating the IC in the presence of a strong electromagnetic field may cause the IC to malfunction.

### 9. Testing on Application Boards

When testing the IC on an application board, connecting a capacitor directly to a low-impedance output pin may subject the IC to stress. Always discharge capacitors completely after each process or step. The IC's power supply should always be turned off completely before connecting or removing it from the test setup during the inspection process. To prevent damage from static discharge, ground the IC during assembly and use similar precautions during transport and storage.

### 10. Inter-pin Short and Mounting Errors

Ensure that the direction and position are correct when mounting the IC on the PCB. Incorrect mounting may result in damaging the IC. Avoid nearby pins being shorted to each other especially to ground, power supply and output pin. Inter-pin shorts could be due to many reasons such as metal particles, water droplets (in very humid environment) and unintentional solder bridge deposited in between pins during assembly to name a few.

### 11. Unused Input Pins

Input pins of an IC are often connected to the gate of a MOS transistor. The gate has extremely high impedance and extremely low capacitance. If left unconnected, the electric field from the outside can easily charge it. The small charge acquired in this way is enough to produce a significant effect on the conduction through the transistor and cause unexpected operation of the IC. So unless otherwise specified, unused input pins should be connected to the power supply or ground line.

## Operational Notes – continued

## 12. Regarding the Input Pin of the IC

This monolithic IC contains P+ isolation and P substrate layers between adjacent elements in order to keep them isolated. P-N junctions are formed at the intersection of the P layers with the N layers of other elements, creating a parasitic diode or transistor. For example (refer to figure below):

When  $GND > Pin A$  and  $GND > Pin B$ , the P-N junction operates as a parasitic diode.

When  $GND > Pin B$ , the P-N junction operates as a parasitic transistor.

Parasitic diodes inevitably occur in the structure of the IC. The operation of parasitic diodes can result in mutual interference among circuits, operational faults, or physical damage. Therefore, conditions that cause these diodes to operate, such as applying a voltage lower than the GND voltage to an input pin (and thus to the P substrate) should be avoided.

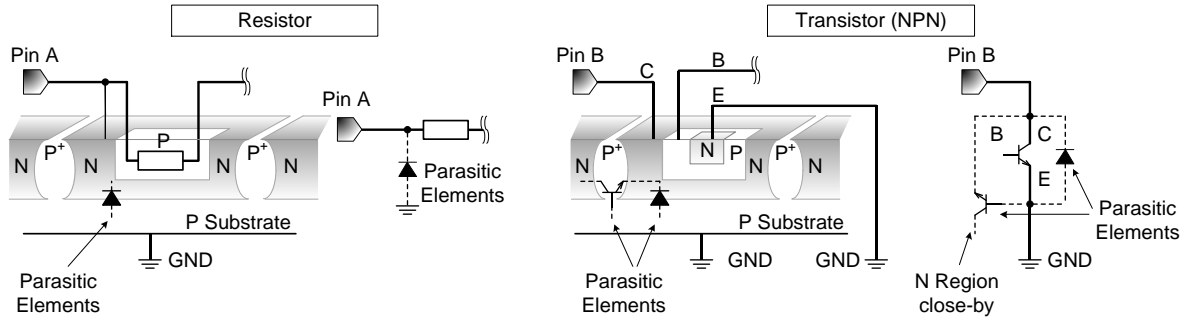

Figure 51. Example of monolithic IC structure

## 13. Ceramic Capacitor

When using a ceramic capacitor, determine the dielectric constant considering the change of capacitance with temperature and the decrease in nominal capacitance due to DC bias and others.

## 14. Thermal Shutdown Circuit(TSD)

This IC has a built-in thermal shutdown circuit that prevents heat damage to the IC. Normal operation should always be within the IC's power dissipation rating. If however the rating is exceeded for a continued period, the junction temperature ( $T_j$ ) will rise which will activate the TSD circuit that will turn OFF all output pins. When the  $T_j$  falls below the TSD threshold, the circuits are automatically restored to normal operation.

Note that the TSD circuit operates in a situation that exceeds the absolute maximum ratings and therefore, under no circumstances, should the TSD circuit be used in a set design or for any purpose other than protecting the IC from heat damage.

## 15. Disturbance light

In a device where a portion of silicon is exposed to light such as in a WL-CSP, IC characteristics may be affected due to photoelectric effect. For this reason, it is recommended to come up with countermeasures that will prevent the chip from being exposed to light.

Ordering Information

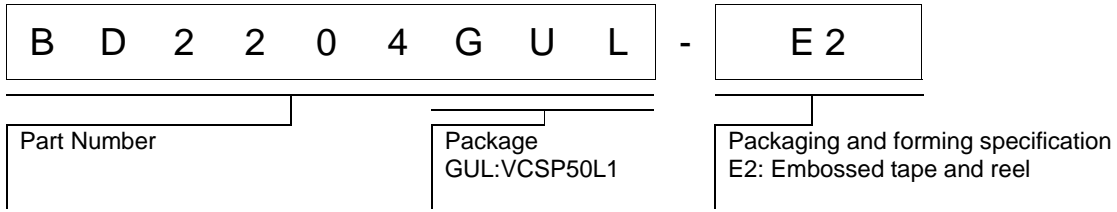

Marking Diagrams

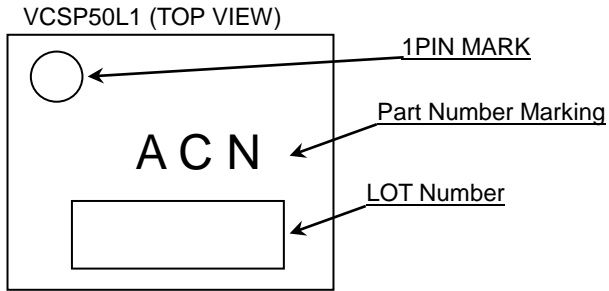

Physical Dimension, Tape and Reel Information

Package Name	VCSP50L1(BD2204GUL)
--------------	---------------------

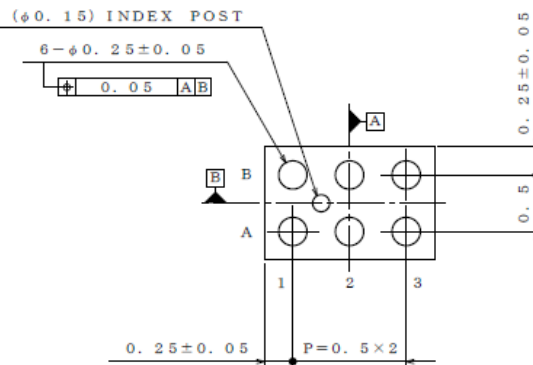
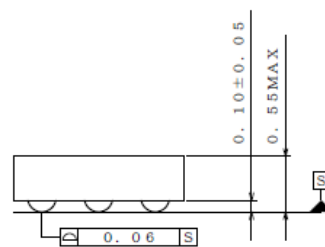
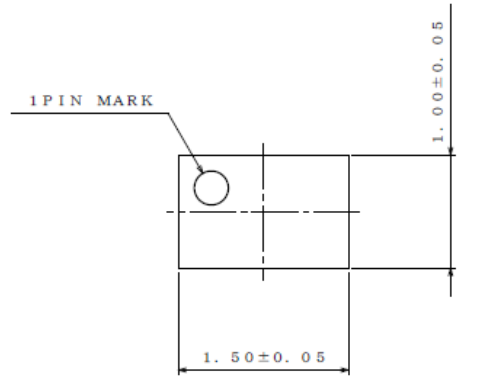

(UNIT : mm)

< Tape and Reel Information >

Tape	Embossed carrier tape
Quantity	3000pcs
Direction of feed	E2 The direction is the pin 1 of product is at the upper left when you hold reel on the left hand and you pull out the tape on the right hand

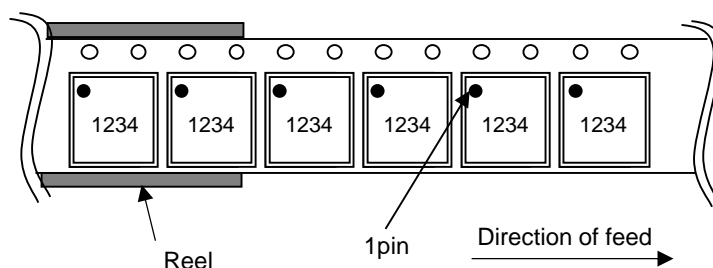

**Revision History**

Date	Revision	Changes
07.Aug.2012	001	New Release
20.Feb.2015	002	Revised pull-down resistance value of Pin Description and Operational Notes.
25.Sep.2015	003	Add Top View of Pin Configuration Revised Figure 38, 39

# Notice

## Precaution on using ROHM Products

- Our Products are designed and manufactured for application in ordinary electronic equipments (such as AV equipment, OA equipment, telecommunication equipment, home electronic appliances, amusement equipment, etc.). If you intend to use our Products in devices requiring extremely high reliability (such as medical equipment <sup>(Note 1)</sup>, transport equipment, traffic equipment, aircraft/spacecraft, nuclear power controllers, fuel controllers, car equipment including car accessories, safety devices, etc.) and whose malfunction or failure may cause loss of human life, bodily injury or serious damage to property ("Specific Applications"), please consult with the ROHM sales representative in advance. Unless otherwise agreed in writing by ROHM in advance, ROHM shall not be in any way responsible or liable for any damages, expenses or losses incurred by you or third parties arising from the use of any ROHM's Products for Specific Applications.

(Note1) Medical Equipment Classification of the Specific Applications

JAPAN	USA	EU	CHINA
CLASS III	CLASS III	CLASS II b	CLASS III
CLASS IV		CLASS III	

- ROHM designs and manufactures its Products subject to strict quality control system. However, semiconductor products can fail or malfunction at a certain rate. Please be sure to implement, at your own responsibilities, adequate safety measures including but not limited to fail-safe design against the physical injury, damage to any property, which a failure or malfunction of our Products may cause. The following are examples of safety measures:
  - Installation of protection circuits or other protective devices to improve system safety
  - Installation of redundant circuits to reduce the impact of single or multiple circuit failure
- Our Products are designed and manufactured for use under standard conditions and not under any special or extraordinary environments or conditions, as exemplified below. Accordingly, ROHM shall not be in any way responsible or liable for any damages, expenses or losses arising from the use of any ROHM's Products under any special or extraordinary environments or conditions. If you intend to use our Products under any special or extraordinary environments or conditions (as exemplified below), your independent verification and confirmation of product performance, reliability, etc. prior to use, must be necessary:
  - Use of our Products in any types of liquid, including water, oils, chemicals, and organic solvents
  - Use of our Products outdoors or in places where the Products are exposed to direct sunlight or dust
  - Use of our Products in places where the Products are exposed to sea wind or corrosive gases, including Cl<sub>2</sub>, H<sub>2</sub>S, NH<sub>3</sub>, SO<sub>2</sub>, and NO<sub>2</sub>
  - Use of our Products in places where the Products are exposed to static electricity or electromagnetic waves
  - Use of our Products in proximity to heat-producing components, plastic cords, or other flammable items
  - Sealing or coating our Products with resin or other coating materials
  - Use of our Products without cleaning residue of flux (even if you use no-clean type fluxes, cleaning residue of flux is recommended); or Washing our Products by using water or water-soluble cleaning agents for cleaning residue after soldering
  - Use of the Products in places subject to dew condensation
- The Products are not subject to radiation-proof design.
- Please verify and confirm characteristics of the final or mounted products in using the Products.
- In particular, if a transient load (a large amount of load applied in a short period of time, such as pulse. is applied, confirmation of performance characteristics after on-board mounting is strongly recommended. Avoid applying power exceeding normal rated power; exceeding the power rating under steady-state loading condition may negatively affect product performance and reliability.
- De-rate Power Dissipation (Pd) depending on Ambient temperature (Ta). When used in sealed area, confirm the actual ambient temperature.
- Confirm that operation temperature is within the specified range described in the product specification.
- ROHM shall not be in any way responsible or liable for failure induced under deviant condition from what is defined in this document.

## Precaution for Mounting / Circuit board design

- When a highly active halogenous (chlorine, bromine, etc.) flux is used, the residue of flux may negatively affect product performance and reliability.
- In principle, the reflow soldering method must be used on a surface-mount products, the flow soldering method must be used on a through hole mount products. If the flow soldering method is preferred on a surface-mount products, please consult with the ROHM representative in advance.

For details, please refer to ROHM Mounting specification

**Precautions Regarding Application Examples and External Circuits**

1. If change is made to the constant of an external circuit, please allow a sufficient margin considering variations of the characteristics of the Products and external components, including transient characteristics, as well as static characteristics.
2. You agree that application notes, reference designs, and associated data and information contained in this document are presented only as guidance for Products use. Therefore, in case you use such information, you are solely responsible for it and you must exercise your own independent verification and judgment in the use of such information contained in this document. ROHM shall not be in any way responsible or liable for any damages, expenses or losses incurred by you or third parties arising from the use of such information.

**Precaution for Electrostatic**

This Product is electrostatic sensitive product, which may be damaged due to electrostatic discharge. Please take proper caution in your manufacturing process and storage so that voltage exceeding the Products maximum rating will not be applied to Products. Please take special care under dry condition (e.g. Grounding of human body / equipment / solder iron, isolation from charged objects, setting of Ionizer, friction prevention and temperature / humidity control).

**Precaution for Storage / Transportation**

1. Product performance and soldered connections may deteriorate if the Products are stored in the places where:
  - [a] the Products are exposed to sea winds or corrosive gases, including Cl<sub>2</sub>, H<sub>2</sub>S, NH<sub>3</sub>, SO<sub>2</sub>, and NO<sub>2</sub>
  - [b] the temperature or humidity exceeds those recommended by ROHM
  - [c] the Products are exposed to direct sunshine or condensation
  - [d] the Products are exposed to high Electrostatic
2. Even under ROHM recommended storage condition, solderability of products out of recommended storage time period may be degraded. It is strongly recommended to confirm solderability before using Products of which storage time is exceeding the recommended storage time period.
3. Store / transport cartons in the correct direction, which is indicated on a carton with a symbol. Otherwise bent leads may occur due to excessive stress applied when dropping of a carton.
4. Use Products within the specified time after opening a humidity barrier bag. Baking is required before using Products of which storage time is exceeding the recommended storage time period.

**Precaution for Product Label**

QR code printed on ROHM Products label is for ROHM's internal use only.

**Precaution for Disposition**

When disposing Products please dispose them properly using an authorized industry waste company.

**Precaution for Foreign Exchange and Foreign Trade act**

Since concerned goods are fallen under listed items of export control prescribed by Foreign exchange and Foreign trade act, the permission based on the act is necessary in case of export.

**Precaution Regarding Intellectual Property Rights**

1. All information and data including but not limited to application example contained in this document is for reference only. ROHM does not warrant that foregoing information or data will not infringe any intellectual property rights or any other rights of any third party regarding such information or data.
2. ROHM shall not have any obligations where the claims, actions or demands arising from the combination of the Products with other articles such as components, circuits, systems or external equipment (including software).
3. No license, expressly or implied, is granted hereby under any intellectual property rights or other rights of ROHM or any third parties with respect to the Products or the information contained in this document. Provided, however, that ROHM will not assert its intellectual property rights or other rights against you or your customers to the extent necessary to manufacture or sell products containing the Products, subject to the terms and conditions herein.

**Other Precaution**



1. This document may not be reprinted or reproduced, in whole or in part, without prior written consent of ROHM.
2. The Products may not be disassembled, converted, modified, reproduced or otherwise changed without prior written consent of ROHM.
3. In no event shall you use in any way whatsoever the Products and the related technical information contained in the Products or this document for any military purposes, including but not limited to, the development of mass-destruction weapons.
4. The proper names of companies or products described in this document are trademarks or registered trademarks of ROHM, its affiliated companies or third parties.

**General Precaution**

1. Before you use our Products, you are requested to carefully read this document and fully understand its contents. ROHM shall not be in any way responsible or liable for failure, malfunction or accident arising from the use of any ROHM's Products against warning, caution or note contained in this document.
2. All information contained in this document is current as of the issuing date and subject to change without any prior notice. Before purchasing or using ROHM's Products, please confirm the latest information with a ROHM sales representative.
3. The information contained in this document is provided on an "as is" basis and ROHM does not warrant that all information contained in this document is accurate and/or error-free. ROHM shall not be in any way responsible or liable for any damages, expenses or losses incurred by you or third parties resulting from inaccuracy or errors of or concerning such information.

## Looking for pricing, stock, or lifecycle information?

Click below to explore more details on WIN SOURCE:

-  [View BD2204GUL-E2 on WIN SOURCE](#)
-  [Rohm Semiconductor](#) Information

## Optimize Your Supply Chain with WIN SOURCE Solutions

-  Global Sourcing Solution
-  Obsolete Management
-  Cost Control Management
-  Shortage Management
-  Alternative Solution
-  Excess Inventory Management